

This book is revised and brought up to date (at irregular intervals) as necessitated by technical progress.

THE RADIO HANDBOOK

Fifteenth Edition

The Standard of the Field —
*for advanced amateurs
practical radiomen
practical engineers
practical technicians*

WILLIAM I. ORR, W6SAI
Editor, 15th Edition

**\$7.50 per copy at
your dealer in U.S.A.**

*(Add 10% on direct
orders to publisher)*



Published and Distributed to the Radio Trade by

Editors and Engineers
LIMITED

SUMMERLAND, CALIFORNIA, U.S.A.

(Distributed to the Book and News Trades and Libraries by the Baker & Taylor Co., Hillside, N. J.)

THE RADIO HANDBOOK

FIFTEENTH EDITION

Copyright, 1959, by

Editors and Engineers, Ltd.
Summerland, California, U.S.A.

Copyright under Pan-American Convention
All Translation Rights Reserved

Printed in U.S.A.

The "Radio Handbook" in Spanish or Italian is available from us at \$8.25 postpaid. French and Dutch editions in preparation.

Outside North America, if more convenient, write: (Spanish) Marcombo, S.A., Av. Jose Antonio, 584, Barcelona, Spain; (Italian) Edizione C.E.L.I., Via Gandino 1, Bologna, Italy; (French or Dutch) P. H. Brans, Ltd., 28 Prins Leopold St., Borgerhout, Antwerp, Belgium.

Other Outstanding Books from the Same Publisher
(See Announcements at Back of Book)

THE RADIOTELEPHONE LICENSE MANUAL

THE SURPLUS RADIO CONVERSION MANUALS

THE WORLD'S RADIO TUBES (RADIO TUBE VADE MECUM)

THE WORLD'S EQUIVALENT TUBES (EQUIVALENT TUBE VADE MECUM)

THE WORLD'S TELEVISION TUBES (TELEVISION TUBE VADE MECUM)

THE RADIO HANDBOOK

15th Edition

Table of Contents

Chapter One. INTRODUCTION TO RADIO.....	11
1-1 Amateur Radio	11
1-2 Station and Operator Licenses	12
1-3 The Amateur Bands	12
1-4 Starting Your Study	14
Chapter Two. DIRECT CURRENT CIRCUITS.....	21
2-1 The Atom	21
2-2 Fundamental Electrical Units and Relationships.....	22
2-3 Electrostatics — Capacitors	30
2-4 Magnetism and Electromagnetism	35
2-5 RC and RL Transients	38
Chapter Three. ALTERNATING CURRENT CIRCUITS.....	41
3-1 Alternating Current	41
3-2 Resonant Circuits	53
3-3 Nonsinusoidal Waves and Transients	58
3-4 Transformers	61
3-5 Electric Filters	63
Chapter Four. VACUUM TUBE PRINCIPLES.....	67
4-1 Thermionic Emission	67
4-2 The Diode	71
4-3 The Triode	72
4-4 Tetrode or Screen Grid Tubes	77
4-5 Mixer and Converter Tubes	79
4-6 Electron Tubes at Very High Frequencies	80
4-7 Special Microwave Electron Tubes	81
4-8 The Cathode-Ray Tube	84
4-9 Gas Tubes	87
4-10 Miscellaneous Tube Types	88
Chapter Five. TRANSISTORS AND SEMI-CONDUCTORS.....	90
5-1 Atomic Structure of Germanium and Silicon	90
5-2 Mechanism of Conduction	90
5-3 The Transistor	92
5-4 Transistor Characteristics	94
5-5 Transistor Circuitry	96
5-6 Transistor Circuits	103

Chapter Six. VACUUM TUBE AMPLIFIERS.....	106
6-1 Vacuum Tube Parameters	106
6-2 Classes and Types of Vacuum-Tube Amplifiers	107
6-3 Biasing Methods	108
6-4 Distortion in Amplifiers	109
6-5 Resistance-Capacitance Coupled Audio-Frequency Amplifiers....	109
6-6 Video-Frequency Amplifiers	113
6-7 Other Interstage Coupling Methods	113
6-8 Phase Inverters	115
6-9 D-C Amplifiers	117
6-10 Single-ended Triode Amplifiers	118
6-11 Single-ended Pentode Amplifiers	120
6-12 Push-Pull Audio Amplifiers	121
6-13 Class B Audio Frequency Power Amplifiers	123
6-14 Cathode-Follower Power Amplifiers	127
6-15 Feedback Amplifiers	129
6-16 Vacuum-Tube Voltmeters	130
Chapter Seven. HIGH FIDELITY TECHNIQUES.....	134
7-1 The Nature of Sound	134
7-2 The Phonograph	136
7-3 The High Fidelity Amplifier	138
7-4 Amplifier Construction	142
7-5 The "Baby Hi Fi"	143
7-6 A High Quality 25 Watt Amplifier	146
Chapter Eight. RADIO FREQUENCY VACUUM TUBE AMPLIFIERS.....	149
Tuned RF Vacuum Tube Amplifiers	149
8-1 Grid Circuit Considerations	149
8-2 Plate-Circuit Considerations	151
Radio-Frequency Power Amplifiers	152
8-3 Class C R-F Power Amplifiers	152
8-4 Class B Radio Frequency Power Amplifiers	157
8-5 Special R-F Power Amplifier Circuits	160
8-6 A Grounded-Grid 304TL Amplifier	163
8-7 Class AB1 Radio Frequency Power Amplifiers	165
Chapter Nine. THE OSCILLOSCOPE.....	170
9-1 A Typical Cathode-Ray Oscilloscope	170
9-2 Display of Waveforms	175
9-3 Lissajous Figures	176
9-4 Monitoring Transmitter Performance with the Oscilloscope	179
9-5 Receiver I-F Alignment with an Oscilloscope	180
9-6 Single Sideband Applications	182
Chapter Ten. SPECIAL VACUUM TUBE CIRCUITS.....	185
10-1 Limiting Circuits	185
10-1 Clamping Circuits	187
10-3 Multivibrators	188
10-4 The Blocking Oscillator	190
10-5 Counting Circuits	190
10-6 Resistance - Capacity Oscillators	191
10-7 Feedback	192

Chapter Eleven. ELECTRONIC COMPUTERS.....	194
11-1 Digital Computers	195
11-2 Binary Notation	195
11-3 Analog Computers	197
11-4 The Operational Amplifier	199
11-5 Solving Analog Problems	200
11-6 Non-linear Functions	202
11-7 Digital Circuitry	204
Chapter Twelve. RADIO RECEIVER FUNDAMENTALS.....	207
12-1 Detection or Demodulation	207
12-2 Superregenerative Receivers	209
12-3 Superheterodyne Receivers	210
12-4 Mixer Noise and Images	212
12-5 R-F Stages	213
12-6 Signal-Frequency Tuned Circuits	216
12-7 I-F Tuned Circuits	218
12-8 Detector, Audio, and Control Circuits	225
12-9 Noise Suppression	227
12-10 Special Considerations in U-H-F Receiver Design	231
12-11 Receiver Adjustment	235
12-12 Receiving Accessories	236
Chapter Thirteen. GENERATION OF RADIO FREQUENCY ENERGY.....	239
13-1 Self-Controlled Oscillators	239
13-2 Quartz Crystal Oscillators	244
13-3 Crystal Oscillator Circuits	247
13-4 Radio Frequency Amplifiers	251
13-5 Neutralization of R.F. Amplifiers	252
13-6 Neutralizing Procedure	255
13-7 Grounded Grid Amplifiers	258
13-8 Frequency Multipliers	258
13-9 Tank Circuit Capacitances	261
13-10 L and Pi Matching Networks	265
13-11 Grid Bias	267
13-12 Protective Circuits for Tetrode Transmitting Tubes	269
13-13 Interstage Coupling	270
13-14 Radio-Frequency Chokes	272
13-15 Parallel and Push-Pull Tube Circuits	273
Chapter Fourteen. R-F FEEDBACK.....	274
14-1 R-F Feedback Circuits	274
14-2 Feedback and Neutralization of a Two-Stage R-F Amplifier....	277
14-3 Neutralization Procedure in Feedback-Type Amplifiers	279
Chapter Fifteen. AMPLITUDE MODULATION.....	282
15-1 Sidebands	282
15-2 Mechanics of Modulation	283
15-3 Systems of Amplitude Modulation	285
15-4 Input Modulation Systems	292
15-5 Cathode Modulation	297
15-6 The Doherty and the Terman-Woodyard Modulated Amplifiers..	298
15-7 Speech Clipping	300
15-8 The Bias-Shift Heising Modulator	307

Chapter Sixteen. FREQUENCY MODULATION AND REDIOTELETYPE	
TRANSMISSION	312
16-1 Frequency Modulation	312
16-2 Direct FM Circuits	315
16-3 Phase Modulation	319
16-4 Reception of FM Signals	321
16-5 Radio Teletype	326
Chapter Seventeen. SIDEBAND TRANSMISSION	327
17-1 Commercial Applications of SSB	327
17-2 Derivation of Single-Sideband Signals	328
17-3 Carrier Elimination Circuits	332
17-4 Generation of Single-Sideband Signals	334
17-5 Single Sideband Frequency Conversion Systems	340
17-6 Distortion Products Due to Nonlinearity of R-F Amplifiers	344
17-7 Sideband Exciters	346
17-8 Reception of Single Sideband Signals	351
17-9 Double Sideband Transmission	353
Chapter Eighteen. TRANSMITTER DESIGN	356
18-1 Resistors	356
18-2 Capacitors	358
18-3 Wire and Inductors	360
18-4 Grounds	362
18-5 Holes, Leads and Shafts	362
18-6 Parasitic Resonances	364
18-7 Parasitic Oscillation in R-F Amplifiers	365
18-8 Elimination of V-H F Parasitic Oscillations	366
18-9 Checking for Parasitic Oscillations	368
Chapter Nineteen. TELEVISION AND BROADCAST INTERFERENCE	371
19-1 Types of Television Interference	371
19-2 Harmonic Radiation	373
19-3 Low-Pass Filters	376
19-4 Broadcast Interference	379
19-5 HI-FI Interference	386
Chapter Twenty. TRANSMITTER KEYING AND CONTROL	387
20-1 Power Systems	387
20-2 Transmitter Control Methods	391
20-3 Safety Precautions	393
20-4 Transmitter Keying	395
20-5 Cathode Keying	397
20-6 Grid Circuit Keying	398
20-7 Screen Grid Keying	399
20-8 Differential Keying Circuits	400
Chapter Twenty-One. RADIATION, PROPAGATION AND TRANSMISSION	
LINES	403
21-1 Radiation from an Antenna	403
21-2 General Characteristics of Antennas	404
21-3 Radiation Resistance and Feed-Point Impedance	407
21-4 Antenna Directivity	410
21-5 Bandwidth	413

21-6	Propagation of Radio Waves	413
21-7	Ground-Wave Communication	414
21-8	Ionospheric Propagation	416
21-9	Transmission Lines	420
21-10	Non-Resonant Transmission Lines	421
21-11	Tuned or Resonant Lines	424
21-12	Line Discontinuities	425
Chapter Twenty-Two. ANTENNAS AND ANTENNA MATCHING.....		426
22-1	End-Fed Half-Wave Horizontal Antennas	426
22-2	Center-Fed Half-Wave Horizontal Antennas	427
22-3	The Half-Wave Vertical Antenna	430
22-4	The Ground Plane Antenna	431
22-5	The Marconi Antenna	432
22-6	Space-Conserving Antennas	434
22-7	Multi-Band Antennas	436
22-8	Matching Non-Resonant Lines to the Antenna	442
22-9	Antenna Construction	448
22-10	Coupling to the Antenna System	451
22-11	Antenna Couplers	454
22-12	A Single-Wire Antenna Tuner	456
Chapter Twenty-Three. HIGH FREQUENCY ANTENNA ARRAYS.....		459
23-1	Directive Antennas	459
23-2	Long Wire Radiators	461
23-3	The V Antenna	462
23-4	The Rhombic Antenna	464
23-5	Stacked-Dipole Arrays	465
23-6	Broadside Arrays	468
23-7	End-Fire Directivity	473
23-8	Combination End-Fire and Broadside Arrays	475
Chapter Twenty-Four. V-H-F AND U-H-F ANTENNAS		477
24-1	Antenna Requirements	477
24-2	Simple Horizontally-Polarized Antennas	479
24-3	Simple Vertically-Polarized Antennas	480
24-4	The Discone Antenna	481
24-5	Helical Beam Antennas	483
24-6	The Corner-Reflector and Horn-Type Antennas	485
24-7	VHF Horizontal Rhombic Antenna	486
24-8	Multi-Element V-H-F Beam Antennas	488
Chapter Twenty-Five. ROTARY BEAMS.....		494
25-1	Unidirectional Parasitic End-Fire Arrays (Yagi Type)	494
25-2	The Two Element Beam	494
25-3	The Three-Element Array	496
25-4	Feed Systems for Parasitic (Yagi) Arrays	498
25-5	Unidirectional Driven Arrays	504
25-6	Bi-Directional Rotatable Arrays	505
25-7	Construction of Rotatable Arrays	506
25-8	Tuning the Array	509
25-9	Antenna Rotation Systems	513
25-10	Indication of Direction	514
25-11	"Three-Bands" Beams	514

Chapter Twenty-Six. MOBILE EQUIPMENT DESIGN AND INSTALLATION.....	515
26-1 Mobile Reception	515
26-2 Mobile Transmitters	521
26-3 Antennas for Mobile Work	522
26-4 Construction and Installation of Mobile Equipment	524
26-5 Vehicular Noise Suppression	527
Chapter Twenty-Seven. RECEIVERS AND TRANSCEIVERS.....	530
27-1 Circuitry and Components	533
27-2 A Simple Transistorized Portable B-C Receiver	533
27-3 A 455 Kc. Mechanical Filter Adapter	535
27-4 A High Performance Amateur Band Receiver	540
27-5 A "Handie-Talkie" for 144 Mc.	547
27-6 Six Meter Transceiver for Home or Car	552
27-7 A "Hot" Transceiver for 28 Megacycles	559
Chapter Twenty-Eight. LOW POWER TRANSMITTERS AND EXCITERS.....	567
28-1 SSB Exciter for Fixed or Mobile Use	567
28-2 A Mobile Transistorized SSB Exciter	574
28-3 A VHF Transceiver of Advanced Design	578
28-4 A Miniaturized SSB Transmitter for 14 Mc.	589
28-5 A Duplex Transmitter-Receiver for 220 Mc.	598
28-6 A High Stability V.F.O. For the DX Operator	604
Chapter Twenty-Nine. HIGH FREQUENCY POWER AMPLIFIERS.....	610
29-1 Power Amplifier Design	610
29-2 Push-Pull Triode Amplifiers	612
29-3 Push-Pull Tetrode Amplifiers	614
29-4 Tetrode Pi-Network Amplifiers	617
29-5 A Compact Linear Amplifier for Mobile SSB	620
29-6 A Multi-band Mobile Linear Amplifier	624
29-7 An Inexpensive Cathode Driven Kilowatt Amplifier	626
29-8 A Low Distortion Sideband Linear Amplifier	629
29-9 Kilowatt Amplifier for Linear or Class C Operation	635
29-10 A 2 Kilowatt P.E.P. All-band Amplifier	640
29-11 A High Power Push-pull Tetrode Amplifier	644
Chapter Thirty. SPEECH AND AMPLITUDE MODULATION EQUIPMENT.....	647
30-1 Modulation	647
30-2 Design of Speech Amplifiers and Modulators	650
30-3 General Purpose Triode Class B Modulator	651
30-4 A 10-Watt Amplifier-Driver	655
30-5 500-Watt 304TL Modulator	656
30-6 A 15-Watt Clipper-Amplifier	657
30-7 A 200-Watt 811-A De-Luxe Modulator	658
30-8 Zero Bias Tetrode Modulators	662
Chapter Thirty-One. TRANSMITTER CONSTRUCTION.....	663
31-1 A 300 Watt Phone/C-W Transmitter for 50/144 Mc.	663
31-2 A De-Luxe Transmitter for the 3.5 - 29.7 Mc. Range	673

Chapter Thirty-Two. POWER SUPPLIES	684
32-1 Power Supply Requirements	684
32-2 Rectification Circuits	689
32-3 Standard Power Supply Circuits	690
32-4 Selenium and Silicon Rectifiers	695
32-5 100 Watt Mobile Power Supply	697
32-6 Transistorized Power Supplies	703
32-7 Two Transistorized Mobile Supplies	706
32-8 Power Supply Components	707
32-9 Special Power Supplies	709
32-10 Power Supply Design	712
32-11 300 Volt, 50 Ma. Power Supply	715
32-12 500 Volt, 200 Milliampere Power Supply	716
32-13 1500 Volt, 425 Milliampere Power Supply	717
32-14 A Dual Voltage Transmitter Supply	718
32-15 A Kilowatt Power Supply	718
Chapter Thirty-Three. WORKSHOP PRACTICE.....	720
33-1 Tools	720
33-2 The Material	723-A
33-3 TVI-Proof Enclosures	724-A
33-4 Enclosure Openings.....	725-A
33-5 Summation of the Problem	725-A
33-6 Construction Practice	726-A
33-7 Shop Layout	729-A
Chapter Thirty-Four. ELECTRONIC TEST EQUIPMENT.....	721-B
34-1 Voltage, Current and Power	721-B
34-2 Measurement of Circuit Constants	727-B
34-3 Measurements with a Bridge	728-B
34-4 Frequency Measurements	729-B
34-5 Antenna and Transmission Line Measurements	730-B
34-6 A Simple Coaxial Reflectometer	732
34-7 Measurements on Balanced Transmission Lines	734
34-8 A "Balanced" SWR Bridge	736
34-9 The Antennascope	738
34-10 A Silicon Crystal Noise Generator	740
Chapter Thirty-Five. RADIO MATHEMATICS AND CALCULATIONS.....	742

FOREWORD TO THE FIFTEENTH EDITION

Over two decades ago the historic first edition of the RADIO HANDBOOK was published as a unique, independent, communications manual written especially for the advanced radio amateur and electronic engineer. Since that early issue, great pains have been taken to keep each succeeding edition of the RADIO HANDBOOK abreast of the rapidly expanding field of electronics.

So quickly has the electron invaded our everyday affairs that it is now no longer possible to segregate one particular branch of electronics and define it as radio communications; rather, the transfer of intelligence by electrical means encompasses more than the vacuum tube, the antenna, and the tuning capacitor.

Included in this new, advanced Fifteenth Edition of the RADIO HANDBOOK are fresh chapters covering electronic computers, r.f. feedback amplifiers, and high fidelity techniques, plus greatly expanded chapters dealing with semi-conductors and special vacuum tube circuits. The other chapters of this Handbook have been thoroughly revised and brought up to date, touching briefly on those aspects in the industrial and military electronic fields that are of immediate interest to the electronic engineer and the radio amateur. The construction chapters have been completely re-edited. All new equipments described therein are of modern design, free of TVI problems and various unwanted parasitic oscillations. An attempt has been made not to duplicate items that have been featured in contemporary magazines. The transceiver makes its major bow in this edition of the RADIO HANDBOOK, and it is felt that this complete, inexpensive, compact "radio station" design will become more popular during the coming years.

The writing and preparation of this Handbook would have been impossible without the lavish help that was tendered the editor by fellow amateurs and sympathetic electronic organizations. Their friendly assistance and helpful suggestions were freely given in the true amateur spirit to help make the 15th edition of the RADIO HANDBOOK an outstanding success.

The editor and publisher wish to thank these individuals and companies whose unselfish support made the compilation and publication of this book an interesting and inspired task.

—WILLIAM I. ORR, W6SAI, 3A2AF, Editor

- | | | |
|--|--|--------------------------------------|
| E. P. Alvernaz, W6DMN,
Jennings Radio Co. | Wesley Schum, W9DYV,
Central Electronics, Inc. | Raytheon Mfg. Co., Inc. |
| Kenneth Bay, W2GSJ,
General Electric Co. | Aaron Self, W8FYR,
Continental Electronics
& Sound Co. | Sarkes-Tarzian, Inc. |
| Orrin H. Brown, W6HB,
Eittel-McCullough, Inc. | Harold Vance, K2FF,
Radio Corporation of
America | Sprague Electric Co. |
| Wm. E. Bruring, W9ZSO,
E. F. Johnson, Inc. | J. A. Haimes, Semi-conductor
Division, Radio Corporation
of America | Triad Transformer Co. |
| Thomas Consalvi, W3EOZ,
Barker & Williamson, Inc. | Special thanks are due Collins
Radio Co. for permission to
reprint portions of their
Sideband Report CTR-113
by Warren Bruene, W0TTK | Bob Adams, W6AVA |
| Cal Hadlock, W1CTW,
National Co., Inc. | Bud Radio Co., Inc. | Frank Clement, W6KPC |
| Jo E. Jennings, W6EL,
Jennings Radio Co. | California Chassis Co., Inc. | Al Cline, W6LGU |
| Al Kahn, W8DUS,
Electrovoice, Inc. | Cardwell Condenser Co., Inc. | Temple Ehmsen, W7VS |
| Ken Klippel, W0SQO,
Collins Radio Co. | Centralab, Inc. | Ted Gillett, W6HX |
| Roger Mace, W8MWZ,
Heath Co. | Cornell-Dubilier Electric
Co., Inc. | Bill Glaser, W6OKG |
| E. R. Mullings, W8VPN,
Heath Co. | Cowan Publishing Corp. | Bill Guimont, W6YMD |
| Edw. A. Neal, W2JZK,
General Electric Co. | International Business
Machines Co., Inc. | Ted Henry, W6UOU |
| Edw. Schmeichel, W9YFV,
Chicago-Standard
Transformer Co. | Marion Electrical
Instrument Co., Inc. | Herbert Johnson, W7GRA |
| | Miller Coil Co., Inc. | James Lee, W6VAT |
| | Raypar, Inc. | Earl Lucas, W2JT |
| | | Bill Mauzey, W6WWQ |
| | | Ken Pierce, W6SLQ |
| | | Don Stoner, W6TNS |
| | | Bob Thompson, K6SSJ |
| | | Karl Trovinger, W6KMK |
| | | Bill Vandermay, W7DET |
| | | Dick West, W6IUG |
| | | Edward Willis, W6TSS |
| | | Joseph Jasgur
(photography) |
| | | B. A. Ontiveros, W6FFF
(drafting) |
| | | Del Rairigh, W6ZAT |

Introduction to Radio

The field of radio is a division of the much larger field of electronics. Radio itself is such a broad study that it is still further broken down into a number of smaller fields of which only shortwave or high-frequency radio is covered in this book. Specifically the field of communication on frequencies from 1.8 to 450 megacycles is taken as the subject matter for this work.

The largest group of persons interested in the subject of high-frequency communication is the more than 150,000 radio amateurs located in nearly all countries of the world. Strictly speaking, a radio amateur is anyone interested in radio non-commercially, but the term is ordinarily applied only to those hobbyists possessing transmitting equipment and a license from the government.

It was for the radio amateur, and particularly for the serious and more advanced amateur, that most of the equipment described in this book was developed. However, in each equipment group simple items also are shown for the student or beginner. The design principles behind the equipment for high-frequency radio communication are of course the same whether the equipment is to be used for commercial, military, or amateur purposes, the principal differences lying in construction practices, and in the tolerances and safety factors placed upon components.

With the increasing complexity of high-frequency communication, resulting primarily from increased utilization of the available spectrum, it becomes necessary to delve more deeply into the basic principles underlying radio communication, both from the standpoint of equipment design and operation and from the standpoint of signal propagation. Hence, it will be found that this edition of the RADIO HANDBOOK has been devoted in greater proportion

to the teaching of the principles of equipment design and signal propagation. It is in response to requests from schools and agencies of the Department of Defense, in addition to persistent requests from the amateur radio fraternity, that coverage of these principles has been expanded.

1-1 Amateur Radio

Amateur radio is a fascinating hobby with many phases. So strong is the fascination offered by this hobby that many executives, engineers, and military and commercial operators enjoy amateur radio as an avocation even though they are also engaged in the radio field commercially. It captures and holds the interest of many people in all walks of life, and in all countries of the world where amateur activities are permitted by law.

Amateurs have rendered much public service through furnishing communications to and from the outside world in cases where disaster has isolated an area by severing all wire communications. Amateurs have a proud record of heroism and service in such occasion. Many expeditions to remote places have been kept in touch with home by communication with amateur stations on the high frequencies. The amateur's fine record of performance with the "wireless" equipment of World War I has been surpassed by his outstanding service in World War II.

By the time peace came in the Pacific in the summer of 1945, many thousand amateur operators were serving in the allied armed forces. They had supplied the army, navy, marines, coast guard, merchant marine, civil service, war plants, and civilian defense organizations with *trained* personnel for radio,

radar, wire, and visual communications and for teaching. Even now, at the time of this writing, amateurs are being called back into the expanded defense forces, are returning to defense plants where their skills are critically needed, and are being organized into communication units as an adjunct to civil defense groups.

1-2 Station and Operator Licenses

Every radio transmitting station in the United States no matter how low its power must have a license from the federal government before being operated; some classes of stations must have a permit from the government even before being constructed. And every operator of a transmitting station must have an operator's license before operating a transmitter. There are no exceptions. Similar laws apply in practically every major country.

Classes of Amateur Operator Licenses There are at present six classes of amateur operator licenses which have been authorized by the Federal Communications Commission. These classes differ in many respects, so each will be discussed briefly.

(a) *Amateur Extra Class.* This class of license is available to any U. S. citizen who at any time has held for a period of two years or more a valid amateur license, issued by the FCC, excluding licenses of the Novice and Technician Classes. The examination for the license includes a code test at 20 words per minute, the usual tests covering basic amateur practice and general amateur regulations, and an additional test on advanced amateur practice. All amateur privileges are accorded the holders of this operator's license.

(b) *General Class.* This class of amateur license is equivalent to the old Amateur Class B license, and accords to the holders all amateur privileges except those which may be set aside for holders of the Amateur Extra Class license. This class of amateur operator's license is available to any U. S. citizen. The examination for the license includes a code test at 13 words per minute, and the usual examinations covering basic amateur practice and general amateur regulations.

(c) *Conditional Class.* This class of amateur license and the privileges accorded by it are equivalent to the General Class license. However, the license can be issued only to those whose residence is more than 125 miles airline from the nearest location at which FCC examinations are held at intervals of not more than three months for the General Class amateur operator license, or to those who for any

of several specified reasons are unable to appear for examination.

(d) *Technician Class.* This is a new class of license which is available to any citizen of the United States. The examination is the same as that for the General Class license, except that the code test is at a speed of 5 words per minute. The holder of a Technician class license is accorded all authorized amateur privileges in the amateur frequency bands above 220 megacycles, and in the 50-Mc. band.

(e) *Novice Class.* This is a new class of license which is available to any U. S. citizen who has not previously held an amateur license of any class issued by any agency of the U. S. government, military or civilian. The examination consists of a code test at a speed of 5 words per minute, plus an examination on the rules and regulations essential to beginner's operation, including sufficient elementary radio theory for the understanding of those rules. The Novice Class of license affords severely restricted privileges, is valid for only a period of one year (as contrasted to all other classes of amateur licenses which run for a term of five years), and is not renewable.

All Novice and Technician class examinations are given by volunteer examiners, as regular examinations for these two classes are not given in FCC offices. Amateur radio clubs in the larger cities have established examining committees to assist would-be amateurs of the area in obtaining their Novice and Technician licenses.

1-3 The Amateur Bands

Certain small segments of the radio frequency spectrum between 1500 kc. and 10,000 Mc. are reserved for operation of amateur radio stations. These segments are in general agreement throughout the world, although certain parts of different amateur bands may be used for other purposes in various geographic regions. In particular, the 40-meter amateur band is used legally (and illegally) for short wave broadcasting by many countries in Europe, Africa and Asia. Parts of the 80-meter band are used for short distance marine work in Europe, and for broadcasting in South America. The amateur bands available to American radio amateurs are:

160 Meters The 160-meter band is divided into 25-kilocycle segments on a regional basis, with day and night power limitations, and is available for amateur use provided no interference is caused to the Loran (Long Range Navigation) stations operating in this band. This band is least affected by the 11-

year solar sunspot cycle. The Maximum Usable Frequency (MUF) even during the years of decreased sunspot activity does not usually drop below 4 Mc., therefore this band is not subject to the violent fluctuations found on the higher frequency bands. DX contacts on this band are limited by the ionospheric absorption of radio signals, which is quite high. During winter nighttime hours the absorption is often of a low enough value to permit trans-oceanic contacts on this band. On rare occasions, contacts up to 10,000 miles have been made. As a usual rule, however, 160-meter amateur operation is confined to ground-wave contacts or single-skip contacts of 1000 miles or less. Popular before World War II, the 160-meter band is now only sparsely occupied since many areas of the country are blanketed by the megawatt pulses of the Lorain chains.

80 Meters The 80-meter band is the (3500 Kc.-4000 Kc.) most popular amateur band in the continental United States for local "rag-chewing" and traffic nets. During the years of minimum sunspot activity the ionospheric absorption on this band may be quite low, and long distance DX contacts are possible during the winter night hours. Daytime operation, in general, is limited to contacts of 500 miles or less. During the summer months, local static and high ionospheric absorption limit long distance contacts on this band. As the sunspot cycle advances and the MUF rises, increased ionospheric absorption will tend to degrade the long distance possibilities of this band. At the peak of the sunspot cycle, the 80-meter band becomes useful only for short-haul communication.

40 Meters The 40-meter band is high (7000 Kc.-7300 Kc.) enough in frequency to be severely affected by the 11-year sunspot cycle. During years of minimum solar activity, the MUF may drop below 7 Mc., and the band will become very erratic, with signals dropping completely out during the night hours. Ionospheric absorption of signals is not as large a problem on this band as it is on 80 and 160 meters. As the MUF gradually rises, the skip-distance will increase on 40 meters, especially during the winter months. At the peak of the solar cycle, the daylight skip distance on 40 meters will be quite long, and stations within a distance of 500 miles or so of each other will not be able to hold communication. DX operation on the 40-meter band is considerably hampered by broadcasting stations, propaganda stations, and jamming trans-

mitters. In Europe and Asia the band is in a chaotic state, and amateur operation in this region is severely hampered.

20 Meters At the present time, (14,000 Kc.-14,350 Kc.) the 20-meter band is by far the most popular band for long distance contacts. High enough in frequency to be almost obliterated at the bottom of the solar cycle, the band nevertheless provides good DX contacts during years of minimal sunspot activity. At the present time, the band is open to almost all parts of the world at some time during the year. During the summer months, the band is active until the late evening hours, but during the winter months the band is only good for a few hours during daylight. Extreme DX contacts are usually erratic, but the 20-meter band is the only band available for DX operation the year around during the bottom of the DX cycle. As the sunspot count increases and the MUF rises, the 20-meter band will become open for longer hours during the winter. The maximum skip distance increases, and DX contacts are possible over paths other than the Great Circle route. Signals can be heard the "long paths," 180 degrees opposite to the Great Circle path. During daylight hours, absorption may become apparent on the 20-meter band, and all signals except very short skip may disappear. On the other hand, the band will be open for worldwide DX contacts all night long. The 20-meter band is very susceptible to "fade-outs" caused by solar disturbances, and all except local signals may completely disappear for periods of a few hours to a day or so.

15 Meters This is a relatively new band for radio amateurs since it has only been available for amateur operation since 1952. Not too much is known about the characteristics of this band, since it has not been occupied for a full cycle of solar activity. However, it is reasonable to assume that it will have characteristics similar to both the 20 and 10-meter amateur bands. It should have a longer skip distance than 20 meters for a given time, and sporadic-E (short-skip) should be apparent during the winter months. During a period of low sunspot activity, the MUF will rarely rise as high as 15 meters, so this band will be "dead" for a large part of the year. During the next few years, 15-meter activity should pick up rapidly, and the band should support extremely long DX contacts. Activity on the 15-meter band is limited in some areas,

since the older model TV receivers have a 21 Mc. i-f channel, which falls directly in the 15-meter band. The interference problems brought about by such an unwise choice of intermediate frequency often restrict operation on this band by amateur stations unfortunate enough to be situated near such an obsolete receiver.

10-Meters (28,000 Kc.-29,700 Kc.) During the peak of the sunspot cycle, the 10-meter band is without doubt the most popular amateur band. The combination of long skip and low ionospheric absorption make reliable DX contacts with low powered equipment possible. The great width of the band (1700 kc.) provides room for a large number of amateurs. The long skip (1500 miles or so) prevents nearby amateurs from hearing each other, thus dropping the interference level. During the winter months, sporadic-E (short skip) signals up to 1200 miles or so will be heard. The 10-meter band is poorest in the summer months, even during a sunspot maximum. Extremely long daylight skip is common on this band, and in years of high MUF the 10-meter band will support intercontinental DX contacts during daylight hours.

The second harmonic of stations operating in the 10-meter band falls directly into television channel 2, and the higher harmonics of 10-meter transmitters fall into the higher TV channels. This harmonic problem seriously curtailed amateur 10-meter operation during the late 40's. However, with the new circuit techniques and TV precautionary measures stressed in this Handbook, 10-meter operation should cause little or no interference to nearby television receivers of modern design.

Six Meters (50 Mc.-54 Mc.) At the peak of the sunspot cycle, the MUF occasionally rises high enough to permit DX contacts up to 10,000 miles or so on 6 meters. Activity on this band during such a period is often quite high. Interest in this band wanes during a period of lesser solar activity, as contacts, as a rule, are restricted to short-skip work. The proximity of the 6-meter band to television channel 2 often causes interference problems to amateurs located in areas where channel 2 is active. As the sunspot cycle increases, activity on the 6-meter band will increase.

The V-H-F Bands (Two Meters and "Up") The v-h-f bands are the least affected by the vagaries of the sunspot cycle and the Heaviside layer. Their predominant use is for reliable communication over distances of 150 miles or less. These

bands are sparsely occupied in the rural sections of the United States, but are quite heavily congested in the urban areas of high population.

In recent years it has been found that v-h-f signals are propagated by other means than by line-of-sight transmission. "Scatter signals," Aurora reflection, and air-mass boundary bending are responsible for v-h-f communication up to 1200 miles or so. Weather conditions will often affect long distance communication on the 2-meter band, and all the v-h-f bands are particularly sensitive to this condition.

The other v-h-f bands have had insufficient occupancy to provide a clear picture of their characteristics. In general, they behave much as does the 2-meter band, with the weather effects becoming more pronounced on the higher frequency bands.

1-4 Starting Your Study

When you start to prepare yourself for the amateur examination you will find that the circuit diagrams, tube characteristic curves, and formulas appear confusing and difficult of understanding. But after a few study sessions one becomes sufficiently familiar with the notation of the diagrams and the basic concepts of theory and operation so that the acquisition of further knowledge becomes easier and even fascinating.

As it takes a considerable time to become proficient in sending and receiving code, it is a good idea to intersperse technical study sessions with periods of code practice. Many short code practice sessions benefit one more than a small number of longer sessions. Alternating between one study and the other keeps the student from getting "stale" since each type of study serves as a sort of respite from the other.

When you have practiced the code long enough you will be able to follow the gist of the slower sending stations. Many stations send very slowly when working other stations at great distances. Stations repeat their calls many times when calling other stations before contact is established, and one need not have achieved much code proficiency to make out their calls and thus determine their location.

The Code The applicant for any class of amateur operator license must be able to send and receive the Continental Code (sometimes called the International Morse Code). The speed required for the sending and receiving test may be either 5, 13, or 20 words per minute, depending upon the class of license, assuming an average of five characters to the word in each case. The sending and re-

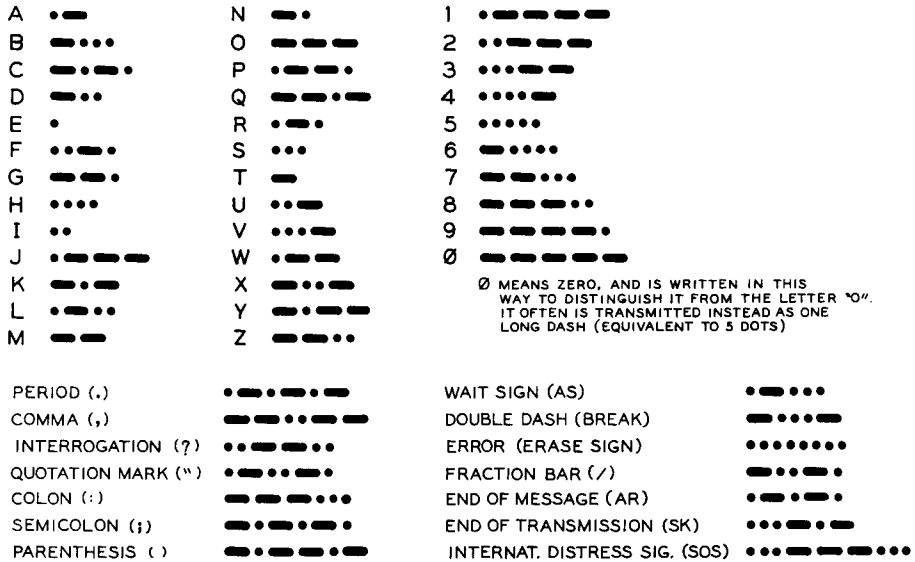

Figure 1

The Continental (or International Morse) Code is used for substantially all non-automatic radio communication. DO NOT memorize from the printed page; code is a language of SOUND, and must not be learned visually; learn by listening as explained in the text.

ceiving tests run for five minutes, and one minute of errorless transmission or reception must be accomplished within the five-minute interval.

If the code test is failed, the applicant must wait at least one month before he may again appear for another test. Approximately 30% of amateur applicants fail to pass the test. It should be expected that nervousness and excitement will at least to some degree temporarily lower the applicant's code ability. The best prevention against this is to master the code at a little greater than the required speed under ordinary conditions. Then if you slow down a little due to nervousness during a test the result will not prove fatal.

Memorizing the Code There is no shortcut to code proficiency. To memorize the alphabet entails but a few evenings of diligent application, but considerable time is required to build up speed. The exact time required depends upon the individual's ability and the regularity of practice.

While the speed of learning will naturally vary greatly with different individuals, about 70 hours of practice (no practice period to be over 30 minutes) will usually suffice to bring a speed of about 13 w.p.m.; 16 w.p.m. requires about 120 hours; 20 w.p.m., 175 hours.

Since code reading requires that individual letters be recognized instantly, any memorizing scheme which depends upon orderly sequence, such as learning all "dab" letters and all "dit" letters in separate groups, is to be discouraged. Before beginning with a code practice set it is necessary to memorize the whole alphabet perfectly. A good plan is to study only two or three letters a day and to drill with those letters until they become part of your consciousness. Mentally translate each day's letters into their sound equivalent wherever they are seen, on signs, in papers, indoors and outdoors. Tackle two additional letters in the code chart each day, at the same time reviewing the characters already learned.

Avoid memorizing by routine. Be able to sound out any letter immediately without so much as hesitating to think about the letters preceding or following the one in question. Know C, for example, apart from the sequence ABC. Skip about among all the characters learned, and before very long sufficient letters will have been acquired to enable you to spell out simple words to yourself in "dit dabs." This is interesting exercise, and for that reason it is good to memorize all the vowels first and the most common consonants next.

Actual code practice should start only when the entire alphabet, the numerals, period, com-

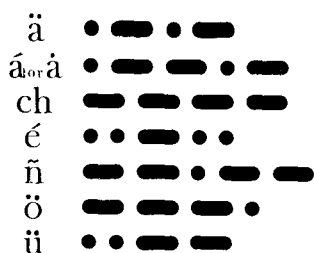

Figure 2

These code characters are used in languages other than English. They may occasionally be encountered so it is well to know them.

ma, and question mark have been memorized so thoroughly that any one can be sounded without the slightest hesitation. Do not bother with other punctuation or miscellaneous signals until later.

Sound — Each letter and figure *must* be memorized by its *sound* rather than its appearance. Code is a system of sound communication, the same as is the spoken word. The letter *A*, for example, is one short and one long sound in combination sounding like *dit dab*, and it must be remembered as such, and not as "dot dash."

Practice Time, patience, and regularity are required to learn the code properly. Do not expect to accomplish it within a few days.

Don't practice too long at one stretch; it does more harm than good. Thirty minutes at a time should be the limit.

Lack of regularity in practice is the most common cause of lack of progress. Irregular practice is very little better than no practice at all. Write down what you have heard; then forget it; *do not look back*. If your mind dwells even for an instant on a signal about which you have doubt, you will miss the next few characters while your attention is diverted.

While various automatic code machines, phonograph records, etc., will give you practice, by far the best practice is to obtain a study companion who is also interested in learning the code. When you have both memorized the alphabet you can start sending to each other. Practice with a key and oscillator or key and buzzer generally proves superior to all automatic equipment. Two such sets operated between two rooms are fine—or between your house and his will be just that much better. Avoid talking to your partner while practicing. If you must ask him a ques-

tion, do it in code. It makes more interesting practice than confining yourself to random practice material.

When two co-learners have memorized the code and are ready to start sending to each other for practice, it is a good idea to enlist the aid of an experienced operator for the first practice session or two so that they will get an idea of how properly formed characters sound.

During the first practice period the speed should be such that substantially solid copy can be made without strain. Never mind if this is only two or three words per minute. In the next period the speed should be increased slightly to a point where nearly all of the characters can be caught only through conscientious effort. When the student becomes proficient at this new speed, another slight increase may be made, progressing in this manner until a speed of about 16 words per minute is attained if the object is to pass the amateur 13-word per minute code test. The margin of 3 w.p.m. is recommended to overcome a possible excitement factor at examination time. Then when you take the test you don't have to worry about the "jitters" or an "off day."

Speed should not be increased to a new level until the student finally makes solid copy with ease for at least a five-minute period at the old level. How frequently increases of speed can be made depends upon individual ability and the amount of practice. Each increase is apt to prove disconcerting, but remember "you are never learning when you are comfortable."

A number of amateurs are sending code practice on the air on schedule once or twice each week; excellent practice can be obtained after you have bought or constructed your receiver by taking advantage of these sessions.

If you live in a medium-size or large city, the chances are that there is an amateur radio club in your vicinity which offers free code practice lessons periodically.

Skill When you listen to someone speaking you do not consciously think how his words are spelled. This is also true when you read. In code you must train your ears to read code just as your eyes were trained in school to read printed matter. With enough practice you acquire skill, and from skill, speed. In other words, it becomes a *habit*, something which can be done without conscious effort. Conscious effort is fatal to speed; we can't think rapidly enough; a speed of 25 words a minute, which is a common one in commercial operations, means 125 characters per minute or more than two per second, which leaves no time for conscious thinking.

Perfect Formation of Characters When transmitting on the code practice set to your partner, concentrate on the *quality* of your sending, *not* on your speed. Your partner will appreciate it and he could not copy you if you speeded up anyhow.

If you want to get a reputation as having an excellent "fist" on the air, just remember that speed alone won't do the trick. Proper execution of your letters and spacing will make much more of an impression. Fortunately, as you get so that you can send evenly and accurately, your sending speed will automatically increase. Remember to try to see how *evenly* you can send, and how *fast* you can receive. Concentrate on making signals properly with your key. Perfect formation of characters is paramount to everything else. Make every signal right no matter if you have to practice it hundreds or thousands of times. Never allow yourself to vary the slightest from perfect formation once you have learned it.

If possible, get a good operator to listen to your sending for a short time, asking him to criticize even the slightest imperfections.

Timing It is of the utmost importance to maintain uniform spacing in characters and combinations of characters. Lack of uniformity at this point probably causes beginners more trouble than any other single factor. Every dot, every dash, and every space must be correctly timed. In other words, accurate timing is absolutely essential to intelligibility, and timing of the spaces between the dots and dashes is just as important as the lengths of the dots and dashes themselves.

The characters are timed with the dot as a "yardstick." A standard dash is three times as long as a dot. The spacing between parts of the same letter is equal to one dot; the space between letters is equal to three dots, and that between words equal to five dots.

The rule for spacing between letters and words is not strictly observed when sending slower than about 10 words per minute for the benefit of someone learning the code and desiring receiving practice. When sending at, say, 5 w.p.m., the individual letters should be made the same as if the sending rate were about 10 w.p.m., except that the spacing between letters and words is greatly exaggerated. The reason for this is obvious. The letter *L*, for instance, will then sound exactly the same at 10 w.p.m. as at 5 w.p.m., and when the speed is increased above 5 w.p.m. the student will not have to become familiar with what may seem to him like a new sound, although it is in reality only a faster combination of dots and dashes. At the greater speed he will merely have to learn the identification of the *same* sound without taking as long to do so.

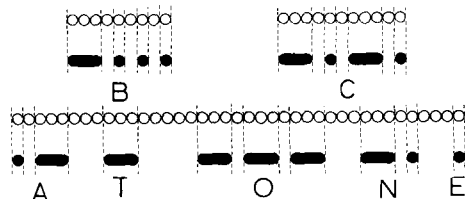

Figure 3

Diagram illustrating relative lengths of dashes and spaces referred to the duration of a dot. A dash is exactly equal in duration to three dots; spaces between parts of a letter equal one dot; those between letters, three dots; space between words, five dots. Note that a slight increase between two parts of a letter will make it sound like two letters.

Be particularly careful of letters like *B*. Many beginners seem to have a tendency to leave a longer space after the dash than that which they place between succeeding dots, thus making it sound like *TS*. Similarly, make sure that you do not leave a longer space after the first dot in the letter *C* than you do between other parts of the same letter; otherwise it will sound like *NN*.

Sending vs. Receiving Once you have memorized the code thoroughly you should concentrate on increasing your *receiving* speed. True, if you have to practice with another newcomer who is learning the code with you, you will both have to do some sending. But don't attempt to practice *sending* just for the sake of increasing your sending *speed*.

When transmitting on the code practice set to your partner so that he can get receiving practice, concentrate on the *quality* of your sending, not on your speed.

Because it is comparatively easy to learn to send rapidly, especially when no particular care is given to the quality of sending, many operators who have just received their licenses get on the air and send mediocre or worse code at 20 w.p.m. when they can barely receive good code at 13. Most oldtimers remember their own period of initiation and are only too glad to be patient and considerate if you tell them that you are a newcomer. But the surest way to incur their scorn is to try to impress them with your "lightning speed," and then to request them to send more slowly when they come back at you at the same speed.

Stress your copying ability; never stress your sending ability. It should be obvious that that if you try to send faster than you can receive, your ear will not recognize any mistakes which your hand may make.

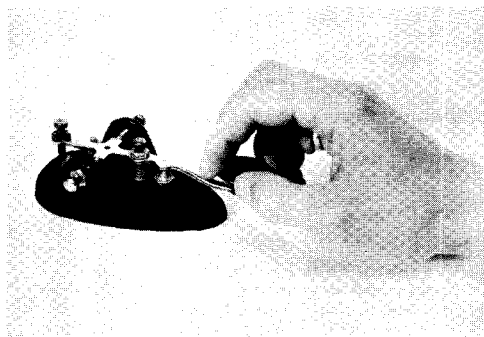

Figure 4

PROPER POSITION OF THE FINGERS FOR OPERATING A TELEGRAPH KEY

The fingers hold the knob and act as a cushion. The hand rests lightly on the key. The muscles of the forearm provide the power, the wrist acting as the fulcrum. The power should not come from the fingers, but rather from the forearm muscles.

Using the Key Figure 4 shows the proper position of the hand, fingers and wrist when manipulating a telegraph or radio key. The forearm should rest naturally on the desk. It is preferable that the key be placed far enough back from the edge of the table (about 18 inches) that the elbow can rest on the table. Otherwise, pressure of the table edge on the arm will tend to hinder the circulation of the blood and weaken the ulnar nerve at a point where it is close to the surface, which in turn will tend to increase fatigue considerably.

The knob of the key is grasped lightly with the thumb along the edge; the index and third fingers rest on the top towards the front or far edge. The hand moves with a free up and down motion, the wrist acting as a fulcrum. The power must come entirely from the arm muscles. The third and index fingers will bend slightly during the sending but not because of deliberate effort to manipulate the finger muscles. Keep your finger muscles just tight enough to act as a cushion for the arm motion and let the slight movement of the fingers take care of itself. The key's spring is adjusted to the individual wrist and should be neither too stiff nor too loose. Use a moderately stiff tension at first and gradually lighten it as you become more proficient. The separation between the contacts must be the proper amount for the desired speed, being somewhat under 1/16 inch for slow speeds and slightly closer together (about 1/32 inch) for faster speeds. Avoid extremes in either direction.

Do not allow the muscles of arm, wrist, or

fingers to become tense. Send with a full, free arm movement. Avoid like the plague any finger motion other than the slight cushioning effect mentioned above.

Stick to the regular hand key for learning code. No other key is satisfactory for this purpose. Not until you have thoroughly mastered both sending and receiving at the maximum speed in which you are interested should you tackle any form of automatic or semi-automatic key such as the Vibroplex ("bug") or an electronic key.

Difficulties Should you experience difficulty in increasing your code speed after you have once memorized the characters, there is no reason to become discouraged. It is more difficult for some people to learn code than for others, but there is no justification for the contention sometimes made that "some people just can't learn the code." It is not a matter of intelligence; so don't feel ashamed if you seem to experience a little more than the usual difficulty in learning code. Your reaction time may be a little slower or your co-ordination not so good. If this is the case, remember *you can still learn the code*. You may never learn to send and receive at 40 w.p.m., but you can learn sufficient speed for all non-commercial purposes and even for most commercial purposes if you have patience, and refuse to be discouraged by the fact that others seem to pick it up more rapidly.

When the sending operator is sending just a bit too fast for you (the best speed for practice), you will occasionally miss a signal or a small group of them. When you do, leave a blank space; do not spend time futilely trying to recall it; dismiss it, and center attention on the next letter; otherwise you'll miss more. Do not ask the sender any questions until the transmission is finished.

To prevent guessing and get equal practice on the less common letters, depart occasionally from plain language material and use a jumble of letters in which the usually less commonly used letters predominate.

As mentioned before, many students put a greater space after the dash in the letter *B* than between other parts of the same letter so it sounds like *TS. C, F, Q, V, X, Y* and *Z* often give similar trouble. Make a list of words or arbitrary combinations in which these letters predominate and practice them, both sending and receiving until they no longer give you trouble. Stop everything else and stick at them. So long as they give you trouble you are not ready for anything else.

Follow the same procedure with letters which you may tend to confuse such as *F* and *L*, which are often confused by beginners.

Figure 5
THE SIMPLEST CODE PRACTICE SET CONSISTS OF A KEY AND A BUZZER

The buzzer is adjusted to give a steady, high-pitched whine. If desired, the phones may be omitted, in which case the buzzer should be mounted firmly on a sounding board. Crystal, magnetic, or dynamic ear-phones may be used. Additional sets of phones should be connected in parallel, not in series.

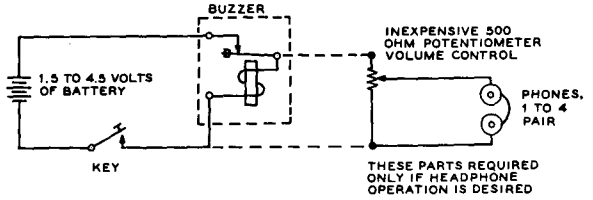

Keep at it until you *always* get them right without having to stop *even an instant* to think about it.

If you do not instantly recognize the sound of any character, you have not learned it; go back and practice your alphabet further. You should never have to omit writing down every signal you hear except when the transmission is too fast for you.

Write down what you hear, not what you think it should be. It is surprising how often the word which you guess will be wrong.

Copying Behind All good operators copy several words behind, that is, while one word is being received, they are writing down or typing, say, the fourth or fifth previous word. At first this is very difficult, but after sufficient practice it will be found actually to be easier than copying close up. It also results in more accurate copy and enables the receiving operator to capitalize and

punctuate copy as he goes along. It is not recommended that the beginner attempt to do this until he can send and receive accurately and with ease at a speed of at least 12 words a minute.

It requires a considerable amount of training to dissociate the action of the subconscious mind from the direction of the conscious mind. It may help some in obtaining this training to write down two columns of short words. Spell the first word in the first column out loud while writing down the first word in the second column. At first this will be a bit awkward, but you will rapidly gain facility with practice. Do the same with all the words, and then reverse columns.

Next try speaking aloud the words in the one column while writing those in the other column; then reverse columns.

After the foregoing can be done easily, try sending with your key the words in one column while spelling those in the other. It won't be easy at first, but it is well worth keeping after if you intend to develop any real code proficiency. Do *not* attempt to catch up. There is a natural tendency to close up the gap, and you must train yourself to overcome this.

Next have your code companion send you a word either from a list or from straight text; do not write it down yet. Now have him send the next word; *after* receiving this second word, write down the first word. After receiving the third word, write the second word; and so on. Never mind how slowly you must go, even if it is only two or three words per minute. *Stay behind.*

It will probably take quite a number of practice sessions before you can do this with any facility. After it is relatively easy, then try staying two words behind; keep this up until it is easy. Then try three words, four words, and five words. The more you practice keeping received material in mind, the easier it will be to stay behind. It will be found easier at first to copy material with which one is fairly familiar, then gradually switch to less familiar material.

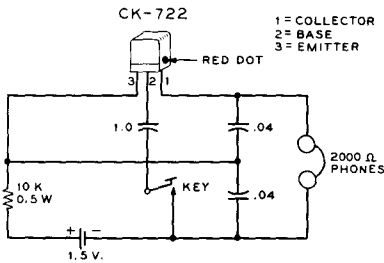

Figure 6
SIMPLE TRANSISTOR CODE PRACTICE OSCILLATOR

An inexpensive Raytheon CK-722 transistor requires only a single 1½-volt flashlight battery for power. The inductance of the ear-phone windings forms part of the oscillatory circuit. The pitch of the note may be changed by varying the value of the two capacitors connected across the earphones.

Automatic Code Machines

The two practice sets which are described in this chapter are of most value when you have someone with whom to practice. Automatic code machines are not recommended to anyone who can possibly obtain a companion with whom to practice, someone who is also interested in learning the code. If you are unable to enlist a code partner and have to practice by yourself, the best way to get receiving practice is by the use of a tape machine (automatic code sending machine) with several practice tapes. Or you can use a set of phonograph code practice records. The records are of use only if you have a phonograph whose turntable speed is readily adjustable. The tape machine can be rented by the month for a reasonable fee.

Once you can copy about 10 w.p.m. you can also get receiving practice by listening to slow sending stations on your receiver. Many amateur stations send slowly particularly when working far distant stations. When receiving conditions are particularly poor many commercial stations also send slowly, sometimes repeating every word. Until you can copy around 10 w.p.m. your receiver isn't much use, and either another operator or a machine or records are necessary for getting receiving practice after you have once memorized the code.

Code Practice Sets

If you don't feel too foolish doing it, you can secure a measure of code practice with

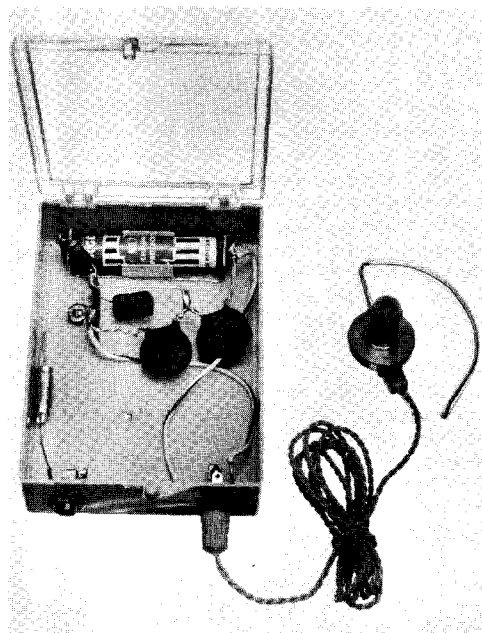

Figure 7

The circuit of Figure 6 is used in this miniature transistorized code practice oscillator. Components are mounted in a small plastic case. The transistor is attached to a three terminal phenolic mounting strip. Sub-miniature jacks are used for the key and phones connections. A hearing aid earphone may also be used, as shown. The phone is stored in the plastic case when not in use.

the help of a partner by sending "dit-dah" messages to each other while riding to work, eating lunch, etc. It is better, however, to use a buzzer or code practice oscillator in conjunction with a regular telegraph key.

As a good key may be considered an investment it is wise to make a well-made key your first purchase. Regardless of what type code practice set you use, you will need a key, and later on you will need one to key your transmitter. If you get a good key to begin with, you won't have to buy another one later.

The key should be rugged and have fairly heavy contacts. Not only will the key stand up better, but such a key will contribute to the "heavy" type of sending so desirable for radio work. Morse (telegraph) operators use a "light" style of sending and can send somewhat faster when using this light touch. But, in radio work static and interference are often present, and a slightly heavier dot is desirable. If you use a husky key, you will find yourself automatically sending in this manner.

To generate a tone simulating a code signal as heard on a receiver, either a mechanical buzzer or an audio oscillator may be used. Figure 5 shows a simple code-practice set using a buzzer which may be used directly simply by mounting the buzzer on a sounding board, or the buzzer may be used to feed from one to four pairs of conventional high-impedance phones.

An example of the audio-oscillator type of code-practice set is illustrated in figures 6 and 7. An inexpensive *Raytheon* CK-722 transistor is used in place of the more expensive, power consuming vacuum tube. A single "pen-lite" 1½-volt cell powers the unit. The coils of the earphones form the inductive portion of the resonant circuit. Phones having an impedance of 2000 ohms or higher should be used. Surplus type R-14 earphones also work well with this circuit.

Direct Current Circuits

All naturally occurring matter (excluding artificially produced radioactive substances) is made up of 92 fundamental constituents called *elements*. These elements can exist either in the free state such as iron, oxygen, carbon, copper, tungsten, and aluminum, or in chemical unions commonly called *compounds*. The smallest unit which still retains all the original characteristics of an element is the *atom*.

Combinations of atoms, or subdivisions of compounds, result in another fundamental unit, the *molecule*. The molecule is the smallest unit of any compound. All reactive elements when in the gaseous state also exist in the molecular form, made up of two or more atoms. The nonreactive gaseous elements helium, neon, argon, krypton, xenon, and radon are the only gaseous elements that ever exist in a stable monatomic state at ordinary temperatures.

2-1 The Atom

An atom is an extremely small unit of matter—there are literally billions of them making up so small a piece of material as a speck of dust. To understand the basic theory of electricity and hence of radio, we must go further and divide the atom into its main components, a positively charged nucleus and a cloud of negatively charged particles that surround the nucleus. These particles, swirling around the nucleus in elliptical orbits at an incredible rate of speed, are called *orbital electrons*.

It is upon the behavior of these electrons when freed from the atom, that depends the study of electricity and radio, as well as allied sciences. Actually it is possible to subdivide the nucleus of the atom into a dozen or

so different particles, but this further subdivision can be left to quantum mechanics and atomic physics. As far as the study of electronics is concerned it is only necessary for the reader to think of the normal atom as being composed of a nucleus having a net positive charge that is exactly neutralized by the one or more orbital electrons surrounding it.

The atoms of different elements differ in respect to the charge on the positive nucleus and in the number of electrons revolving around this charge. They range all the way from hydrogen, having a net charge of one on the nucleus and one orbital electron, to uranium with a net charge of 92 on the nucleus and 92 orbital electrons. The number of orbital electrons is called the *atomic number* of the element.

Action of the Electrons From the above it must not be thought that the electrons revolve in a haphazard manner around the nucleus. Rather, the electrons in an element having a large atomic number are grouped into rings having a definite number of electrons. The only atoms in which these rings are completely filled are those of the inert gases mentioned before; all other elements have one or more uncompleted rings of electrons. If the uncompleted ring is nearly empty, the element is *metallic* in character, being most metallic when there is only one electron in the outer ring. If the incomplete ring lacks only one or two electrons, the element is usually *non-metallic*. Elements with a ring about half completed will exhibit both non-metallic and metallic characteristics; carbon, silicon, germanium, and arsenic are examples. Such elements are called *semi-conductors*.

In metallic elements these outer ring electrons are rather loosely held. Consequently,

there is a continuous helter-skelter movement of these electrons and a continual shifting from one atom to another. The electrons which move about in a substance are called *free electrons*, and it is the ability of these electrons to drift from atom to atom which makes possible the *electric current*.

Conductors and Insulators If the free electrons are numerous and loosely held, the element is a good conductor.

On the other hand, if there are few free electrons, as is the case when the electrons in an outer ring are tightly held, the element is a poor conductor. If there are virtually no free electrons, the element is a good insulator.

2-2 Fundamental Electrical Units and Relationships

Electromotive Force: Potential Difference The free electrons in a conductor move constantly about and change their position in a haphazard manner. To produce a drift of electrons or *electric current* along a wire it is necessary that there be a difference in "pressure" or *potential* between the two ends of the wire. This *potential difference* can be produced by connecting a source of *electrical potential* to the ends of the wire.

As will be explained later, there is an excess of electrons at the negative terminal of a battery and a deficiency of electrons at the positive terminal, due to chemical action. When the battery is connected to the wire, the deficient atoms at the positive terminal attract free electrons from the wire in order for the positive terminal to become neutral. The attracting of electrons continues through the wire, and finally the excess electrons at the negative terminal of the battery are attracted by the positively charged atoms at the end of the wire. Other sources of electrical potential (in addition to a battery) are: an electrical generator (dynamo), a thermocouple, an electrostatic generator (static machine), a photoelectric cell, and a crystal or piezoelectric generator.

Thus it is seen that a potential difference is the result of a difference in the number of electrons between the two (or more) points in question. The force or pressure due to a potential difference is termed the *electromotive force*, usually abbreviated *e.m.f.* or *E.M.F.* It is expressed in units called *volts*.

It should be noted that for there to be a potential difference between two bodies or points it is not necessary that one have a positive charge and the other a negative charge. If two bodies each have a negative

charge, but one more negative than the other, the one with the lesser negative charge will act as though it were positively charged *with respect to the other body*. It is the *algebraic potential difference* that determines the force with which electrons are attracted or repulsed, the potential of the earth being taken as the zero reference point.

The Electric Current The flow of electrons along a conductor due to the application of an electromotive force constitutes an electric current. This drift is in addition to the irregular movements of the electrons. However, it must not be thought that each free electron travels from one end of the circuit to the other. On the contrary, each free electron travels only a short distance before colliding with an atom; this collision generally knocking off one or more electrons from the atom, which in turn move a short distance and collide with other atoms, knocking off other electrons. Thus, in the general drift of electrons along a wire carrying an electric current, each electron travels only a short distance and the excess of electrons at one end and the deficiency at the other are balanced by the source of the e.m.f. When this source is removed the state of normalcy returns; there is still the rapid interchange of free electrons between atoms, but there is no general trend or "net movement" in either one direction or the other.

Ampere and Coulomb There are two units of measurement associated with current, and they are often confused. The *rate of flow* of electricity is stated in *amperes*. The unit of *quantity* is the *coulomb*. A coulomb is equal to 6.28×10^{18} electrons, and when this quantity of electrons flows by a given point in every second, a current of one ampere is said to be flowing. An ampere is equal to one coulomb per second; a coulomb is, conversely, equal to one ampere-second. Thus we see that *coulomb* indicates *amount*, and *ampere* indicates *rate of flow* of electric current.

Older textbooks speak of current flow as being from the positive terminal of the e.m.f. source through the conductor to the negative terminal. Nevertheless, it has long been an established fact that the current flow in a metallic conductor is the *electronic* flow from the negative terminal of the source of voltage through the conductor to the positive terminal. The only exceptions to the electronic direction of flow occur in gaseous and electrolytic conductors where the flow of positive ions toward the cathode or negative electrode constitutes a positive flow in the opposite direction to the electronic flow. (An ion is an atom, molecule,

or particle which either lacks one or more electrons, or else has an excess of one or more electrons.)

In radio work the terms "electron flow" and "current" are becoming accepted as being synonymous, but the older terminology is still accepted in the electrical (industrial) field. Because of the confusion this sometimes causes, it is often safer to refer to the direction of electron flow rather than to the direction of the "current." Since electron flow consists actually of a passage of *negative* charges, current flow and *algebraic* electron flow do pass in the same direction.

Resistance The flow of current in a material depends upon the ease with which electrons can be detached from the atoms of the material and upon its molecular structure. In other words, the easier it is to detach electrons from the atoms the more free electrons there will be to contribute to the flow of current, and the fewer collisions that occur between free electrons and atoms the greater will be the total electron flow.

The opposition to a steady electron flow is called the *resistance* of a material, and is one of its physical properties.

The unit of resistance is the *ohm*. Every substance has a *specific resistance*, usually expressed as *ohms per mil-foot*, which is determined by the material's molecular structure and temperature. A mil-foot is a piece of material one circular mil in area and one foot long. Another measure of resistivity frequently used is expressed in the units *microhms per centimeter cube*. The resistance of a uniform length of a given substance is directly proportional to its length and specific resistance, and inversely proportional to its cross-sectional area. A wire with a certain resistance for a given length will have twice as much resistance if the length of the wire is doubled. For a given length, doubling the cross-sectional area of the wire will *halve* the resistance, while doubling the *diameter* will reduce the resistance to *one fourth*. This is true since the cross-sectional area of a wire varies as the square of the diameter. The relationship between the resistance and the linear dimensions of a conductor may be expressed by the following equation:

$$R = \frac{r l}{A}$$

Where

R = resistance in ohms

r = resistivity in *Ohms per mil-foot*

l = length of conductor in feet

A = cross-sectional area in circular mils

TABLE OF RESISTIVITY		
Material	Resistivity in Ohms per Circular Mil-Foot	Temp. Coeff. of resistance per °C at 20° C.
Aluminum	17	0.0049
Brass	45	0.003 to 0.007
Cadmium	46	0.0038
Chromium	16	0.00
Copper	10.4	0.0039
Iron	59	0.006
Silver	9.8	0.004
Zinc	36	0.0035
Nichrome	650	0.0002
Constantan	295	0.00001
Manganin	290	0.00001
Monel	255	0.0019

FIGURE 1

The resistance also depends upon temperature, increasing with increases in temperature for most substances (including most metals), due to increased electron acceleration and hence a greater number of impacts between electrons and atoms. However, in the case of some substances such as carbon and glass the temperature coefficient is negative and the resistance decreases as the temperature increases. This is also true of electrolytes. The temperature may be raised by the external application of heat, or by the flow of the current itself. In the latter case, the temperature is raised by the heat generated when the electrons and atoms collide.

Conductors and Insulators In the molecular structure of many materials such as glass, porcelain, and mica all electrons are tightly held within their orbits and there are comparatively few free electrons. This type of substance will conduct an electric current only with great difficulty and is known as an *insulator*. An insulator is said to have a high electrical *resistance*.

On the other hand, materials that have a large number of free electrons are known as *conductors*. Most metals, those elements which have only one or two electrons in their outer ring, are good conductors. Silver, copper, and aluminum, in that order, are the best of the common metals used as conductors and are said to have the greatest *conductivity*, or lowest resistance to the flow of an electric current.

Fundamental Electrical Units These units are the *volt*, the *ampere*, and the *ohm*.

They were mentioned in the preceding paragraphs, but were not completely defined in terms of fixed, known quantities.

The fundamental unit of *current*, or *rate of flow of electricity* is the ampere. A current of one ampere will deposit silver from a specified solution of silver nitrate at a rate of 1.118 milligrams per second.

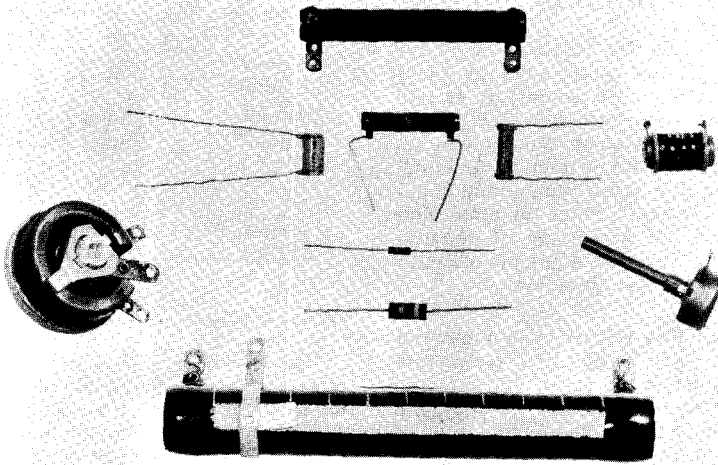

Figure 2
TYPICAL RESISTORS

Shown above are various types of resistors used in electronic circuits. The larger units are power resistors. On the left is a variable power resistor. Three precision-type resistors are shown in the center with two small composition resistors beneath them. At the right is a composition-type potentiometer, used for audio circuitry.

The international standard for the ohm is the resistance offered by a uniform column of mercury at 0° C., 14.4521 grams in mass, of constant cross-sectional area and 106.300 centimeters in length. The expression *megohm* (1,000,000 ohms) is also sometimes used when speaking of very large values of resistance.

A volt is the e.m.f. that will produce a current of one ampere through a resistance of one ohm. The standard of electromotive force is the Weston cell which at 20° C. has a potential of 1.0183 volts across its terminals. This cell is used only for reference purposes in a bridge circuit, since only an infinitesimal

amount of current may be drawn from it without disturbing its characteristics.

Ohm's Law The relationship between the electromotive force (voltage), the flow of current (amperes), and the resistance which impedes the flow of current (ohms), is very clearly expressed in a simple but highly valuable law known as *Ohm's law*. This law states that *the current in amperes is equal to the voltage in volts divided by the resistance in ohms*. Expressed as an equation:

$$I = \frac{E}{R}$$

If the voltage (E) and resistance (R) are known, the current (I) can be readily found. If the voltage and current are known, and the resistance is unknown, the resistance (R) is

equal to $\frac{E}{I}$. When the voltage is the un-

known quantity, it can be found by multiplying $I \times R$. These three equations are all secured from the original by simple transposition. The expressions are here repeated for quick reference:

$$I = \frac{E}{R} \quad R = \frac{E}{I} \quad E = IR$$

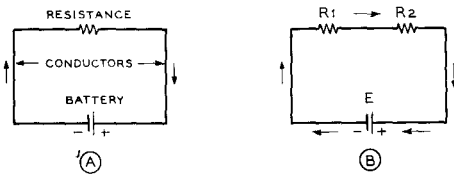

Figure 3
SIMPLE SERIES CIRCUITS

At (A) the battery is in series with a single resistor. At (B) the battery is in series with two resistors, the resistors themselves being in series. The arrows indicate the direction of electron flow.

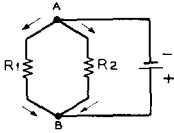

Figure 4
SIMPLE PARALLEL
CIRCUIT

The two resistors R_1 and R_2 are said to be in parallel since the flow of current is offered two parallel paths. An electron leaving point A will pass either through R_1 or R_2 , but not through both, to reach the positive terminal of the battery. If a large number of electrons are considered, the greater number will pass through whichever of the two resistors has the lower resistance.

where I is the current in amperes,
 R is the resistance in ohms,
 E is the electromotive force in volts.

Application of Ohm's Law All electrical circuits fall into one of three classes: series circuits, parallel circuits, and series-parallel circuits. A series circuit is one in which the current flows in a single continuous path and is of the same value at every point in the circuit (figure 3). In a parallel circuit there are two or more current paths between two points in the circuit, as shown in figure 4. Here the current divides at A, part going through R_1 and part through R_2 , and combines at B to return to the battery. Figure 5 shows a series-parallel circuit. There are two paths between points A and B as in the parallel circuit, and in addition there are two resistances in series in each branch of the parallel combination. Two other examples of series-parallel arrangements appear in figure 6. The way in which the current splits to flow through the parallel branches is shown by the arrows.

In every circuit, each of the parts has some resistance: the batteries or generator, the connecting conductors, and the apparatus itself. Thus, if each part has some resistance, no matter how little, and a current is flowing through it, there will be a voltage drop across it. In other words, there will be a potential difference between the two ends of the circuit element in question. This drop in voltage is equal to the product of the current and the resistance, hence it is called the IR drop.

The source of voltage has an *internal* resistance, and when connected into a circuit so that current flows, there will be an IR drop in the source just as in every other part of the circuit. Thus, if the terminal voltage of the source could be measured in a way that would cause no current to flow, it would be found to be more than the voltage measured when a current flows by the amount of the IR drop

Figure 5
SERIES-PARALLEL
CIRCUIT

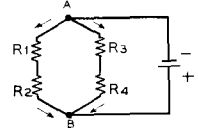

In this type of circuit the resistors are arranged in series groups, and these seriesed groups are then placed in parallel.

in the source. The voltage measured with no current flowing is termed the *no load* voltage; that measured with current flowing is the *load* voltage. It is apparent that a voltage source having a low internal resistance is most desirable.

Resistances in Series The current flowing in a series circuit is equal to the voltage impressed divided by the *total* resistance across which the voltage is impressed. Since the same current flows through every part of the circuit, it is merely necessary to add all the individual resistances to obtain the total resistance. Expressed as a formula:

$$R_{\text{total}} = R_1 + R_2 + R_3 + \dots + R_N .$$

Of course, if the resistances happened to be all the same value, the total resistance would be the resistance of one multiplied by the number of resistors in the circuit.

Resistances in Parallel Consider two resistors, one of 100 ohms and one of 10 ohms, connected in parallel as in figure 4, with a voltage of 10 volts applied across each resistor, so the current through each can be easily calculated.

$$I = \frac{E}{R}$$

$$E = 10 \text{ volts} \quad I_1 = \frac{10}{100} = 0.1 \text{ ampere}$$

$$R = 100 \text{ ohms}$$

$$E = 10 \text{ volts} \quad I_2 = \frac{10}{10} = 1.0 \text{ ampere}$$

$$R = 10 \text{ ohms}$$

$$\text{Total current} = I_1 + I_2 = 1.1 \text{ ampere}$$

Until it divides at A, the entire current of 1.1 amperes is flowing through the conductor from the battery to A, and again from B through the conductor to the battery. Since this is more current than flows through the smaller resistor it is evident that the resistance of the parallel combination must be less than 10 ohms, the resistance of the smaller resistor. We can find this value by applying Ohm's law.

$$R = \frac{E}{I}$$

$$E = 10 \text{ volts} \quad I = 1.1 \text{ amperes} \quad R = \frac{10}{1.1} = 9.09 \text{ ohms}$$

The resistance of the parallel combination is 9.09 ohms.

Mathematically, we can derive a simple formula for finding the effective resistance of two resistors connected in parallel.

This formula is:

$$R = \frac{R_1 \times R_2}{R_1 + R_2}$$

where R is the unknown resistance,

R_1 is the resistance of the first resistor,

R_2 is the resistance of the second resistor.

If the effective value required is known, and it is desired to connect one unknown resistor in parallel with one of known value, the following transposition of the above formula will simplify the problem of obtaining the unknown value:

$$R_2 = \frac{R_1 \times R}{R_1 - R}$$

where R is the effective value required,

R_1 is the known resistor,

R_2 is the value of the unknown resistance necessary to give R when in parallel with R_1 .

The resultant value of placing a number of unlike resistors in parallel is equal to the reciprocal of the sum of the reciprocals of the various resistors. This can be expressed as:

$$R = \frac{1}{\frac{1}{R_1} + \frac{1}{R_2} + \frac{1}{R_3} + \dots + \frac{1}{R_n}}$$

The effective value of placing any number of unlike resistors in parallel can be determined from the above formula. However, it is commonly used only when there are three or more resistors under consideration, since the simplified formula given before is more convenient when only two resistors are being used.

From the above, it also follows that when two or more resistors of the same value are placed in parallel, the effective resistance of the paralleled resistors is equal to the value of one of the resistors divided by the number of resistors in parallel.

The effective value of resistance of two or

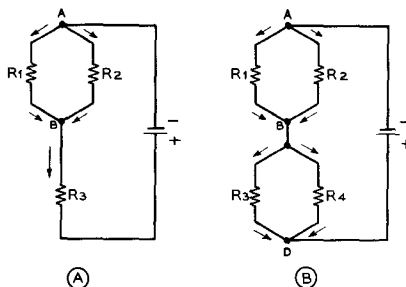

Figure 6
OTHER COMMON SERIES-PARALLEL
CIRCUITS

more resistors connected in parallel is *always* less than the value of the lowest resistance in the combination. It is well to bear this simple rule in mind, as it will assist greatly in approximating the value of paralleled resistors.

Resistors in Series Parallel To find the total resistance of several resistors connected in series-parallel, it is usually easiest to apply either the formula for series resistors or the parallel resistor formula first, in order to reduce the original arrangement to a simpler one. For instance, in figure 5 the series resistors should be added in each branch, then there will be but two resistors in parallel to be calculated. Similarly in figure 7, although here there will be three parallel resistors after adding the series resistors in each branch. In figure 6B the paralleled resistors should be reduced to the equivalent series value, and then the series resistance values can be added.

Resistances in series-parallel can be solved by combining the series and parallel formulas into one similar to the following (refer to figure 7):

$$R = \frac{1}{\frac{1}{R_1 + R_2} + \frac{1}{R_3 + R_4} + \frac{1}{R_5 + R_6 + R_7}}$$

Voltage Dividers A voltage divider is exactly what its name implies: a resistor or a series of resistors connected across a source of voltage from which various lesser values of voltage may be obtained by connection to various points along the resistor.

A voltage divider serves a most useful purpose in a radio receiver, transmitter or amplifier, because it offers a simple means of obtaining plate, screen, and bias voltages of different values from a common power supply

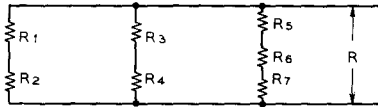

Figure 7
ANOTHER TYPE OF
SERIES-PARALLEL CIRCUIT

source. It may also be used to obtain very low voltages of the order of .01 to .001 volt with a high degree of accuracy, even though a means of measuring such voltages is lacking. The procedure for making these measurements can best be given in the following example.

Assume that an accurately calibrated voltmeter reading from 0 to 150 volts is available, and that the source of voltage is exactly 100 volts. This 100 volts is then impressed through a resistance of exactly 1,000 ohms. It will, then, be found that the voltage along various points on the resistor, with respect to the grounded end, is exactly proportional to the resistance at that point. From Ohm's law, the current would be 0.1 ampere; this current remains unchanged since the original value of resistance (1,000 ohms) and the voltage source (100 volts) are unchanged. Thus, at a 500-ohm point on the resistor (half its entire resistance), the voltage will likewise be halved or reduced to 50 volts.

The equation ($E = I \times R$) gives the proof: $E = 500 \times 0.1 = 50$. At the point of 250 ohms on the resistor, the voltage will be one-fourth the total value, or 25 volts ($E = 250 \times 0.1 = 25$). Continuing with this process, a point can be found where the resistance measures exactly 1 ohm and where the voltage equals 0.1 volt. It is, therefore, obvious that if the original source of voltage and the resistance can be measured, it is a simple matter to predetermine the voltage at any point along the resistor, provided that the current remains constant, and provided that no current is taken from the tap-on point unless this current is taken into consideration.

Voltage Divider Calculations Proper design of a voltage divider for any type of radio equipment is a relatively simple matter. The first consideration is the amount of "bleeder current" to be drawn. In addition, it is also necessary that the desired voltage and the exact current at each tap on the voltage divider be known.

Figure 8 illustrates the flow of current in a simple voltage divider and load circuit. The light arrows indicate the flow of bleeder current, while the heavy arrows indicate the flow of the load current. The design of a combined

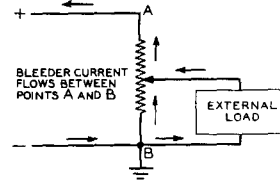

Figure 8
SIMPLE VOLTAGE DIVIDER
CIRCUIT

The arrows indicate the manner in which the current flow divides between the voltage divider itself and the external load circuit.

bleeder resistor and voltage divider, such as is commonly used in radio equipment, is illustrated in the following example:

A power supply delivers 300 volts and is conservatively rated to supply all needed current for the receiver and still allow a bleeder current of 10 milliamperes. The following voltages are wanted: 75 volts at 2 milliamperes for the detector tube, 100 volts at 5 milliamperes for the screens of the tubes, and 250 volts at 20 milliamperes for the plates of the tubes. The required voltage drop across R_1 is 75 volts, across R_2 25 volts, across R_3 150 volts, and across R_4 it is 50 volts. These values are shown in the diagram of figure 9. The respective current values are also indicated. Apply Ohm's law:

$$R_1 = \frac{E}{I} = \frac{75}{.01} = 7,500 \text{ ohms.}$$

$$R_2 = \frac{E}{I} = \frac{25}{.012} = 2,083 \text{ ohms.}$$

$$R_3 = \frac{E}{I} = \frac{150}{.017} = 8,823 \text{ ohms.}$$

$$R_4 = \frac{E}{I} = \frac{50}{.037} = 1,351 \text{ ohms.}$$

$$R_{Total} = 7,500 + 2,083 + 8,823 + 1,351 = 19,757 \text{ ohms.}$$

A 20,000-ohm resistor with three sliding taps will be of the approximately correct size, and would ordinarily be used because of the difficulty in securing four separate resistors of the exact odd values indicated, and because no adjustment would be possible to compensate for any slight error in estimating the probable currents through the various taps.

When the sliders on the resistor once are set to the proper point, as in the above ex-

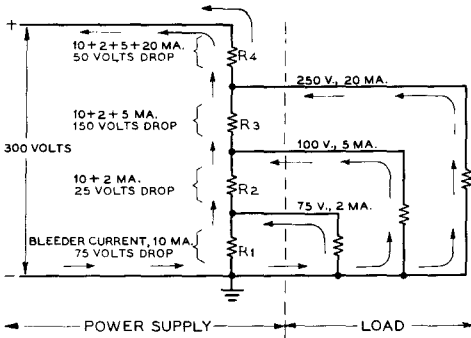

Figure 9
MORE COMPLEX VOLTAGE DIVIDER
 The method for computing the values of the resistors is discussed in the accompanying text.

ample, the voltages will remain constant at the values shown as long as the current remains a constant value.

Disadvantages of Voltage Dividers One of the serious disadvantages of the voltage divider becomes evident when the current drawn from one of the taps changes. It is obvious that the voltage drops are interdependent and, in turn, the individual drops are in proportion to the current which flows through the respective sections of the divider resistor. The only remedy lies in providing a heavy steady bleeder current in order to make the individual currents so small a part of the total current that any change in current will result in only a slight change in voltage. This can seldom be realized in practice because of the excessive values of bleeder current which would be required.

Kirchhoff's Laws Ohm's law is all that is necessary to calculate the values in simple circuits, such as the preceding examples; but in more complex problems, involving several loops or more than one voltage in the same closed circuit, the use of Kirchhoff's laws will greatly simplify the calculations. These laws are merely rules for applying Ohm's law.

Kirchhoff's first law is concerned with net current to a point in a circuit and states that:

At any point in a circuit the current flowing toward the point is equal to the current flowing away from the point.

Stated in another way: if currents flowing to the point are considered positive, and those flowing from the point are considered nega-

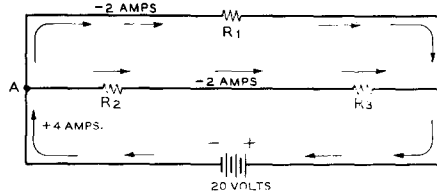

Figure 10
ILLUSTRATING KIRCHHOFF'S FIRST LAW

The current flowing toward point "A" is equal to the current flowing away from point "A."

tive, the sum of all currents flowing toward and away from the point—taking signs into account—is equal to zero. Such a sum is known as an algebraic sum; such that the law can be stated thus: *The algebraic sum of all currents entering and leaving a point is zero.*

Figure 10 illustrates this first law. Since the effective resistance of the network of resistors is 5 ohms, it can be seen that 4 amperes flow toward point A, and 2 amperes flow away through the two 5-ohm resistors in series. The remaining 2 amperes flow away through the 10-ohm resistor. Thus, there are 4 amperes flowing to point A and 4 amperes flowing away from the point. If R is the effective resistance of the network (5 ohms), $R_1 = 10$ ohms, $R_2 = 5$ ohms, $R_3 = 5$ ohms, and $E = 20$ volts, we can set up the following equation:

$$\frac{E}{R} - \frac{E}{R_1} - \frac{E}{R_2 + R_3} = 0$$

$$\frac{20}{5} - \frac{20}{10} - \frac{20}{5 + 5} = 0$$

$$4 - 2 - 2 = 0$$

Kirchhoff's second law is concerned with net voltage drop around a closed loop in a circuit and states that:

In any closed path or loop in a circuit the sum of the IR drops must equal the sum of the applied e.m.f.'s.

The second law also may be conveniently stated in terms of an algebraic sum as: *The algebraic sum of all voltage drops around a closed path or loop in a circuit is zero.* The applied e.m.f.'s (voltages) are considered positive, while IR drops taken in the direction of current flow (including the internal drop of the sources of voltage) are considered negative.

Figure 11 shows an example of the application of Kirchhoff's laws to a comparatively simple circuit consisting of three resistors and

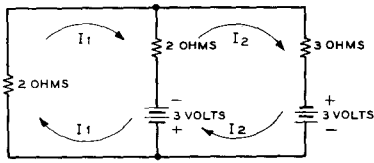

1. SET VOLTAGE DROPS AROUND EACH LOOP EQUAL TO ZERO.
 $I_1 2_{(OHMS)} + 2(I_1 - I_2) + 3 = 0$ (FIRST LOOP)
 $-6 + 2(I_2 - I_1) + 3 I_2 = 0$ (SECOND LOOP)
2. SIMPLIFY
 $2I_1 + 2I_1 - 2I_2 + 3 = 0$ $2I_2 - 2I_1 + 3I_2 - 6 = 0$
 $\frac{4I_1 + 3}{2} = I_2$ $\frac{5I_2 - 2I_1 - 6}{5} = I_2$
3. EQUATE
 $\frac{4I_1 + 3}{2} = \frac{2I_1 + 6}{5}$
4. SIMPLIFY
 $20I_1 + 15 = 4I_1 + 12$
 $I_1 = -\frac{3}{16}$ AMPERE
5. RE-SUBSTITUTE
 $I_2 = \frac{-\frac{3}{16} + 3}{2} = \frac{2\frac{1}{8}}{2} = 1\frac{1}{8}$ AMPERE

Figure 11
ILLUSTRATING KIRCHHOFF'S
SECOND LAW

The voltage drop around any closed loop in a network is equal to zero.

two batteries. First assume an arbitrary direction of current flow in each closed loop of the circuit, drawing an arrow to indicate the assumed direction of current flow. Then equate the sum of all IR drops plus battery drops around each loop to zero. You will need one equation for each unknown to be determined. Then solve the equations for the unknown currents in the general manner indicated in figure 11. If the answer comes out positive the direction of current flow you originally assumed was correct. If the answer comes out negative, the current flow is in the opposite direction to the arrow which was drawn originally. This is illustrated in the example of figure 11 where the direction of flow of I_1 is opposite to the direction assumed in the sketch.

Power in Resistive Circuits In order to cause electrons to flow through a conductor, constituting a current flow, it is necessary to apply an electromotive force (voltage) across the circuit. Less power is expended in creating a small current flow through a given resistance than in creating a large one; so it is necessary to have a unit of power as a reference.

The unit of electrical power is the *watt*, which is the rate of energy consumption when

an e.m.f. of 1 volt forces a current of 1 ampere through a circuit. The power in a resistive circuit is equal to the product of the voltage applied across, and the current flowing in, a given circuit. Hence: P (watts) = E (volts) \times I (amperes).

Since it is often convenient to express power in terms of the resistance of the circuit and the current flowing through it, a substitution of IR for E ($E = IR$) in the above formula gives: $P = IR \times I$ or $P = I^2R$. In terms of voltage and resistance, $P = E^2/R$. Here, $I = E/R$ and when this is substituted for I in the original formula becomes $P = E \times E/R$, or $P = E^2/R$. To repeat these three expressions:

$$P = EI, P = I^2R, \text{ and } P = E^2/R,$$

where P is the power in watts,
 E is the electromotive force in volts, and
 I is the current in amperes.

To apply the above equations to a typical problem: The voltage drop across a cathode resistor in a power amplifier stage is 50 volts; the plate current flowing through the resistor is 150 milliamperes. The number of watts the resistor will be required to dissipate is found from the formula: $P = EI$, or $50 \times .150 = 7.5$ watts (.150 amperes is equal to 150 milliamperes). From the foregoing it is seen that a 7.5-watt resistor will safely carry the required current, yet a 10- or 20-watt resistor would ordinarily be used to provide a safety factor.

In another problem, the conditions being similar to those above, but with the resistance ($R = 333\frac{1}{3}$ ohms), and current being the *known* factors, the solution is obtained as follows: $P = I^2R = .0225 \times 333.33 = 7.5$. If only the voltage and resistance are known, $P = E^2/R = 2500/333.33 = 7.5$ watts. It is seen that all three equations give the same results; the selection of the particular equation depends only upon the known factors.

Power, Energy and Work It is important to remember that power (expressed in watts, horsepower, etc.), represents the *rate* of energy consumption or the *rate* of doing work. But when we pay our electric bill

Figure 12
MATCHING OF
RESISTANCES

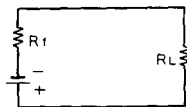

To deliver the greatest amount of power to the load, the load resistance R_L should be equal to the internal resistance of the battery R_1 .

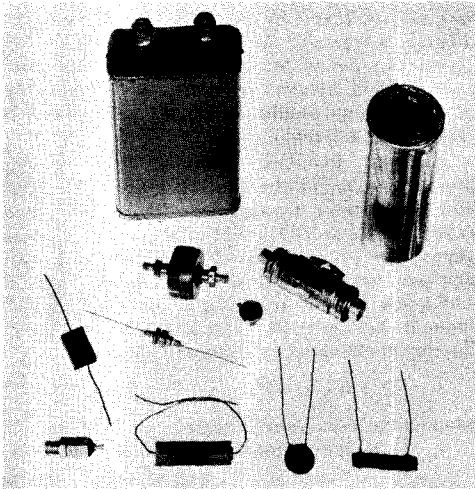

Figure 13
TYPICAL CAPACITORS

The two large units are high value filter capacitors. Shown beneath these are various types of by-pass capacitors for r-f and audio application.

to the power company we have purchased a specific amount of energy or work expressed in the common units of *kilowatt-hours*. Thus rate of energy consumption (watts or kilowatts) multiplied by *time* (seconds, minutes or hours) gives us total energy or work. Other units of energy are the watt-second, BTU, calorie, erg, and joule.

Heating Effect Heat is generated when a source of voltage causes a current to flow through a resistor (or, for that matter, through any conductor). As explained earlier, this is due to the fact that heat is given off when free electrons collide with the atoms of the material. More heat is generated in high resistance materials than in those of low resistance, since the free electrons must strike the atoms harder to knock off other electrons. As the heating effect is a function of the current flowing and the resistance of the circuit, the power expended in heat is given by the second formula: $P = I^2R$.

2.3 Electrostatics — Capacitors

Electrical energy can be stored in an electrostatic field. A device capable of storing energy in such a field is called *capacitor* (in earlier usage the term *condenser* was frequently used but the IRE standards call for the use of capacitor instead of condenser) and

is said to have a certain *capacitance*. The energy stored in an electrostatic field is expressed in *joules* (watt seconds) and is equal to $CE^2/2$, where C is the capacitance in *farads* (a unit of capacitance to be discussed) and E is the potential in volts. The *charge* is equal to CE, the charge being expressed in coulombs.

Capacitance and Two metallic plates separated from each other by a thin layer of insulating material (called a *dielectric*, in this case), becomes a *capacitor*. When a source of d-c potential is momentarily applied across these plates, they may be said to become charged. If the same two plates are then joined together momentarily by means of a switch, the capacitor will *discharge*.

When the potential was first applied, electrons immediately flowed from one plate to the other through the battery or such source of d-c potential as was applied to the capacitor plates. However, the circuit from plate to plate in the capacitor was *incomplete* (the two plates being separated by an insulator) and thus the electron flow ceased, meanwhile establishing a shortage of electrons on one plate and a surplus of electrons on the other.

Remember that when a deficiency of electrons exists at one end of a conductor, there is always a tendency for the electrons to move about in such a manner as to re-establish a state of balance. In the case of the capacitor herein discussed, the surplus quantity of electrons on one of the capacitor plates cannot move to the other plate because the circuit has been broken; that is, the battery or d-c potential was removed. This leaves the capacitor in a *charged* condition; the capacitor plate with the electron *deficiency* is *positively* charged, the other plate being *negative*.

In this condition, a considerable stress exists in the insulating material (dielectric) which separates the two capacitor plates, due to the mutual attraction of two unlike potentials on the plates. This stress is known as *electrostatic* energy, as contrasted with *electromagnetic* energy in the case of an inductor. This charge can also be called *potential energy* because it is capable of performing work when the charge is released through an external circuit. The charge is proportional to the voltage but the energy is proportional to the voltage squared, as shown in the following analogy.

The charge represents a definite amount of electricity, or a given number of electrons. The potential energy possessed by these electrons depends not only upon their number, but also upon their potential or voltage.

Compare the electrons to water, and two capacitors to standpipes, a 1 μfd . capacitor to

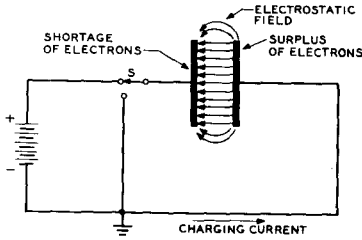

Figure 14
SIMPLE CAPACITOR

Illustrating the imaginary lines of force representing the paths along which the repelling force of the electrons would act on a free electron located between the two capacitor plates.

a standpipe having a cross section of 1 square inch and a 2 μ fd. capacitor to a standpipe having a cross section of 2 square inches. The charge will represent a given volume of water, as the "charge" simply indicates a certain number of electrons. Suppose the water is equal to 5 gallons.

Now the potential energy, or capacity for doing work, of the 5 gallons of water will be twice as great when confined to the 1 sq. in. standpipe as when confined to the 2 sq. in. standpipe. Yet the volume of water, or "charge" is the same in either case.

Likewise a 1 μ fd. capacitor charged to 1000 volts possesses twice as much potential energy as does a 2 μ fd. capacitor charged to 500 volts, though the *charge* (expressed in *coulombs*: $Q = CE$) is the same in either case.

The Unit of Capacitance: The Farad If the external circuit of the two capacitor plates is completed by joining the terminals together with a piece of wire, the electrons will rush immediately from one plate to the other through the external circuit and establish a state of equilibrium. This latter phenomenon explains the *discharge* of a capacitor. The amount of stored energy in a charged capacitor is dependent upon the charging potential, as well as a factor which takes into account the *size* of the plates, *dielectric thickness*, *nature* of the dielectric, and the *number* of plates. This factor, which is determined by the foregoing, is called the *capacitance* of a capacitor and is expressed in *farads*.

The farad is such a large unit of capacitance that it is rarely used in radio calculations, and the following more practical units have, therefore, been chosen.

1 *microfarad* = 1/1,000,000 of a farad, or .000001 farad, or 10^{-6} farads.

1 *micro-microfarad* = 1/1,000,000 of a *microfarad*, or .000001 *microfarad*, or 10^{-6} *microfarads*.

1 *micro-microfarad* = one-millionth of one-millionth of a farad, or 10^{-12} farads.

If the capacitance is to be expressed in *microfarads* in the equation given for *energy storage*, the factor C would then have to be divided by 1,000,000, thus:

$$\text{Stored energy in joules} = \frac{C \times E^2}{2 \times 1,000,000}$$

This storage of energy in a capacitor is one of its very important properties, particularly in those capacitors which are used in power supply filter circuits.

Dielectric Although any substance which has **Materials** the characteristics of a good insulator may be used as a dielectric material, commercially manufactured capacitors make use of dielectric materials which have been selected because their characteristics are particularly suited to the job at hand. Air is a very good dielectric material, but an air-spaced capacitor does not have a high capacitance since the dielectric constant of air is only slightly greater than one. A group of other commonly used dielectric materials is listed in figure 15.

Certain materials, such as bakelite, lucite, and other plastics dissipate considerable energy when used as capacitor dielectrics.

TABLE OF DIELECTRIC MATERIALS			
MATERIAL	DIELECTRIC CONSTANT	POWER FACTOR	SOFTENING POINT
	10 MC.	10 MC.	FAHRENHEIT
ANILINE-FORMALDEHYDE RESIN	3.4	0.004	260*
BARIUM TITANATE	1200	1.0	—
CASTOR OIL	4.67		
CELLULOSE ACETATE	3.7	0.04	180*
GLASS, WINDOW	6-8	POOR	2000*
GLASS, PYREX	4.5	0.02	
KEL-F FLUOROTHENE	2.5	0.6	—
METHYL-METHACRYLATE-LUCITE	2.6	0.007	160*
MICA	5.4	0.0003	
MYCALEX, MYKROY	7.0	0.002	650*
PHENOL-FORMALDEHYDE, LOW-LOSS YELLOW	5.0	0.015	270*
PHENOL-FORMALDEHYDE BLACK BAKELITE	5.5	0.03	350*
PORCELAIN	7.0	0.005	2800*
POLYETHYLENE	2.25	0.0003	220*
POLYSTYRENE	2.55	0.0002	175*
QUARTZ, FUSED	4.2	0.0002	2800*
RUBBER, HARD-EBONITE	2.8	0.007	150*
STEATITE	6.1	0.003	2700*
SULFUR	3.8	0.003	238*
TEFLON	2.1	0.02	—
TITANIUM DIOXIDE	100-175	0.0006	2700*
TRANSFORMER OIL	2.2	0.003	
UREA-FORMALDEHYDE	5.0	0.05	260*
VINYL RESINS	4.0	0.02	200*
WOOD, MAPLE	4.4	POOR	

FIGURE 15

This energy loss is expressed in terms of the *power factor* of the capacitor, which represents the portion of the input volt-amperes lost in the dielectric material. Other materials including air, polystyrene and quartz have a very low power factor.

The new *ceramic* dielectrics such as steatite (talc) and titanium dioxide products are especially suited for high frequency and high temperature operation. Ceramics based upon titanium dioxide have an unusually high dielectric constant combined with a low power factor. The temperature coefficient with respect to capacity of units made with this material depends upon the mixture of oxides, and coefficients ranging from zero to over -700 parts per million per degree Centigrade may be obtained in commercial production.

Mycalex is a composition of minute mica particles and lead borate glass, mixed and fired at a relatively low temperature. It is hard and brittle, but can be drilled or machined when water is used as the cutting lubricant.

Mica dielectric capacitors have a very low power factor and extremely high voltage breakdown per unit of thickness. A mica and copper-foil "sandwich" is formed under pressure to obtain the desired capacity value. The effect of temperature upon the pressures in the "sandwich" causes the capacity of the usual mica capacitor to have large, non-cyclic variations. If the copper electrodes are plated directly upon the mica sheets, the temperature coefficient can be stabilized at about 20 parts per million per degree Centigrade. A process of this type is used in the manufacture of "silver mica" capacitors.

Paper dielectric capacitors consist of strips of aluminum foil insulated from each other by a thin layer of paper, the whole assembly being wrapped in a circular bundle. The cost of such a capacitor is low, the capacity is high in proportion to the size and weight, and the power factor is good. The life of such a capacitor is dependent upon the moisture penetration of the paper dielectric and upon the applied d-c voltage.

Air dielectric capacitors are used in transmitting and receiving circuits, principally where a variable capacitor of high resetability is required. The dielectric strength is high, though somewhat less at radio frequencies than at 60 cycles. In addition, corona discharge at high frequencies will cause ionization of the air dielectric causing an increase in power loss. Dielectric strength may be increased by increasing the air pressure, as is done in hermetically sealed radar units. In some units, dry nitrogen gas may be used in place of air to provide a higher dielectric strength than that of air.

Likewise, the dielectric strength of an "air"

capacitor may be increased by placing the unit in a vacuum chamber to prevent ionization of the dielectric.

The temperature coefficient of a variable air dielectric capacitor varies widely and is often non-cyclic. Such things as differential expansion of various parts of the capacitor, changes in internal stresses and different temperature coefficients of various parts contribute to these variances.

Dielectric Constant The capacitance of a capacitor is determined by the thickness and nature of the dielectric material between plates. Certain materials offer a greater capacitance than others, depending upon their physical makeup and chemical constitution. This property is expressed by a constant *K*, called the dielectric constant. ($K = 1$ for air.)

Dielectric Breakdown If the charge becomes too great for a given thickness of a certain dielectric, the capacitor will break down, i.e., the dielectric will puncture. It is for this reason that capacitors are rated in the manner of the amount of voltage they will safely withstand as well as the capacitance in microfarads. This rating is commonly expressed as the *d-c working voltage*.

Calculation of Capacitance The capacitance of two parallel plates is given with good accuracy by the following formula:

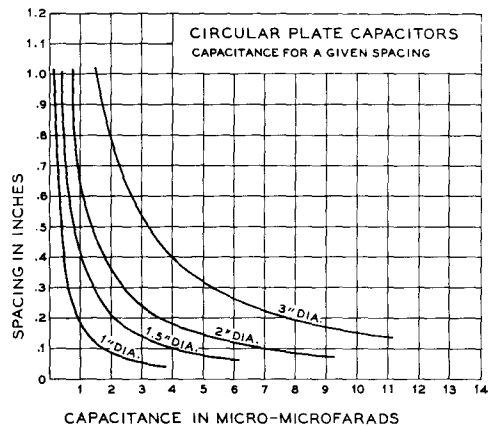

Figure 16

Through the use of this chart it is possible to determine the required plate diameter (with the necessary spacing established by peak voltage considerations) for a circular-plate neutralizing capacitor. The capacitance given is for a dielectric of air and the spacing given is between adjacent faces of the two plates.

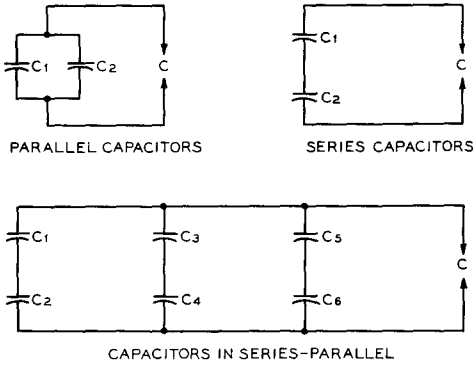

Figure 17
CAPACITORS IN SERIES, PARALLEL,
AND SERIES-PARALLEL

$$C = 0.2248 \times K \times \frac{A}{t}$$

where C = capacitance in micro-microfarads,
K = dielectric constant of spacing material,
A = area of dielectric in square inches,
t = thickness of dielectric in inches.

This formula indicates that the capacitance is directly proportional to the area of the plates and inversely proportional to the thickness of the dielectric (spacing between the plates). This simply means that when the area of the plate is doubled, the spacing between plates remaining constant, the capacitance will be doubled. Also, if the area of the plates remains constant, and the plate spacing is doubled, the capacitance will be reduced to half.

The above equation also shows that capacitance is directly proportional to the dielectric constant of the spacing material. An air-spaced capacitor that has a capacitance of 100 $\mu\mu\text{fd}$. in air would have a capacitance of 467 $\mu\mu\text{fd}$. when immersed in castor oil, because the dielectric constant of castor oil is 4.67 times as great as the dielectric constant of air.

Where the area of the plates is definitely set, when it is desired to know the spacing needed to secure a required capacitance,

$$t = \frac{A \times 0.2248 \times K}{C}$$

where all units are expressed just as in the preceding formula. This formula is not confined to capacitors having only square or

rectangular plates, but also applies when the plates are circular in shape. The only change will be the calculation of the *area* of such circular plates; this area can be computed by squaring the *radius* of the plate, then multiplying by 3.1416, or "pi." Expressed as an equation:

$$A = 3.1416 \times r^2$$

where r = radius in inches

The capacitance of a multi-plate capacitor can be calculated by taking the capacitance of one section and multiplying this by the number of dielectric spaces. In such cases, however, the formula gives no consideration to the effects of edge capacitance; so the capacitance as calculated will not be entirely accurate. These additional capacitances will be but a small part of the effective total capacitance, particularly when the plates are reasonably large and thin, and the final result will, therefore, be within practical limits of accuracy.

Capacitors in Parallel and in Series Equations for calculating capacitances of capacitors in *parallel* connections are the same as those for resistors in *series*.

$$C = C_1 + C_2 + \dots + C_n$$

Capacitors in *series* connection are calculated in the same manner as are resistors in *parallel* connection.

The formulas are repeated: (1) For two or more capacitors of *unequal* capacitance in series:

$$C = \frac{1}{\frac{1}{C_1} + \frac{1}{C_2} + \frac{1}{C_3}}$$

or $\frac{1}{C} = \frac{1}{C_1} + \frac{1}{C_2} + \frac{1}{C_3}$

(2) Two capacitors of *unequal* capacitance in series:

$$C = \frac{C_1 \times C_2}{C_1 + C_2}$$

(3) Three capacitors of *equal* capacitance in series:

$$C = \frac{C_1}{3} \text{ where } C_1 \text{ is the common capacitance.}$$

(4) Three or more capacitors of *equal* capacitance in series.

$$C = \frac{\text{Value of common capacitance}}{\text{Number of capacitors in series}}$$

(5) Six capacitors in series parallel:

$$C = \frac{1}{\frac{1}{C_1} + \frac{1}{C_2} + \frac{1}{C_3} + \frac{1}{C_4} + \frac{1}{C_5} + \frac{1}{C_6}}$$

Capacitors in A-C and D-C Circuits When a capacitor is connected into a direct-current circuit, it will block the d.c., or stop the flow of current. Beyond the initial movement of electrons during the period when the capacitor is being charged, there will be no flow of current because the circuit is effectively broken by the dielectric of the capacitor.

Strictly speaking, a very small current may actually flow because the dielectric of the capacitor may not be a perfect insulator. This minute current flow is the leakage current previously referred to and is dependent upon the internal d-c resistance of the capacitor. This leakage current is usually quite noticeable in most types of electrolytic capacitors.

When an alternating current is applied to a capacitor, the capacitor will charge and discharge a certain number of times per second in accordance with the frequency of the alternating voltage. The electron flow in the charge and discharge of a capacitor when an a-c potential is applied constitutes an alternating current, in effect. It is for this reason that a capacitor will pass an alternating current yet offer practically infinite opposition to a direct current. These two properties are repeatedly in evidence in a radio circuit.

Voltage Rating of Capacitors in Series Any good paper dielectric filter capacitor has such a high internal resistance (indicating a good dielectric)

that the exact resistance will vary considerably from capacitor to capacitor even though they are made by the same manufacturer and are of the same rating. Thus, when 1000 volts d.c. is connected across two 1- μ fd. 500-volt capacitors in series, the chances are that the voltage will divide unevenly and one capacitor will receive more than 500 volts and the other less than 500 volts.

Voltage Equalizing Resistors By connecting a half-megohm 1-watt carbon resistor across each capacitor, the voltage will be equalized because the resistors act as a voltage divider, and the internal resistances of the capacitors are so much higher (many megohms) that they have but little effect in disturbing the voltage divider balance.

Carbon resistors of the inexpensive type are not particularly accurate (not being designed for precision service); therefore it is

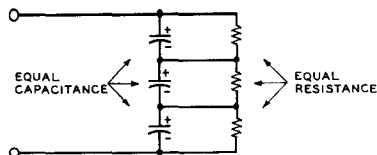

Figure 18
SHOWING THE USE OF VOLTAGE EQUALIZING RESISTORS ACROSS CAPACITORS CONNECTED IN SERIES

advisable to check several on an accurate ohmmeter to find two that are as close as possible in resistance. The exact resistance is unimportant, just so it is the same for the two resistors used.

Capacitors in Series on A.C. When two capacitors are connected in series, alternating voltage pays no heed to the relatively high internal resistance of each capacitor, but divides across the capacitors in inverse proportion to the *capacitance*. Because, in addition to the d.c. across a capacitor in a filter or audio amplifier circuit there is usually an a-c or a-f voltage component, it is inadvisable to series-connect capacitors of unequal capacitance even if dividers are provided to keep the d.c. within the ratings of the individual capacitors.

For instance, if a 500-volt 1- μ fd. capacitor is used in series with a 4- μ fd. 500-volt capacitor across a 250-volt a-c supply, the 1- μ fd. capacitor will have 200 volts a.c. across it and the 4- μ fd. capacitor only 50 volts. An equalizing divider to do any good in this case would have to be of very low resistance because of the comparatively low impedance of the capacitors to a.c. Such a divider would draw excessive current and be impracticable.

The safest rule to follow is to use only capacitors of the same capacitance and voltage rating and to install matched high resistance proportioning resistors across the various capacitors to equalize the d-c voltage drop across each capacitor. This holds regardless of how many capacitors are series-connected.

Electrolytic Capacitors Electrolytic capacitors use a very thin film of oxide as the dielectric, and are polarized; that is, they have a positive and a negative terminal which must be properly connected in a circuit; otherwise, the oxide will break down and the capacitor will overheat. The unit then will no longer be of service. When electrolytic capacitors are connected in series, the positive terminal is always connected to the positive lead of the power supply; the negative terminal of

the capacitor connects to the positive terminal of the *next* capacitor in the series combination. The method of connection for electrolytic capacitors in series is shown in figure 18. Electrolytic capacitors have very low cost per microfarad of capacity, but also have a large power factor and high leakage; both dependent upon applied voltage, temperature and the age of the capacitor. The modern electrolytic capacitor uses a dry paste electrolyte embedded in a gauze or paper dielectric. Aluminium foil and the dielectric are wrapped in a circular bundle and are mounted in a cardboard or metal box. Etched electrodes may be employed to increase the effective anode area, and the total capacity of the unit.

The capacity of an electrolytic capacitor is affected by the applied voltage, the usage of the capacitor, and the temperature and humidity of the environment. The capacity usually drops with the aging of the unit. The leakage current and power factor increase with age. At high frequencies the power factor becomes so poor that the electrolytic capacitor acts as a series resistance rather than as a capacity.

2-4 Magnetism and Electromagnetism

The common bar or horseshoe magnet is familiar to most people. The magnetic field which surrounds it causes the magnet to attract other magnetic materials, such as iron nails or tacks. Exactly the same kind of magnetic field is set up around any conductor carrying a current, but the field exists only while the current is flowing.

Magnetic Fields Before a potential, or voltage, is applied to a conductor there is no external field, because there is no general movement of the electrons in one direction. However, the electrons do progressively move along the conductor when an e.m.f. is applied, the direction of motion depending upon the polarity of the e.m.f. Since each electron has an electric field about it, the flow of electrons causes these fields to build up into a resultant external field which acts in a plane at right angles to the direction in which the current is flowing. This field is known as the *magnetic field*.

The magnetic field around a current-carrying conductor is illustrated in figure 19. The direction of this magnetic field depends entirely upon the direction of electron drift or current flow in the conductor. When the flow is toward the observer, the field about the conductor is clockwise; when the flow is away from the observer, the field is counter-clockwise. This is easily remembered if the left hand is clenched, with the thumb outstretched

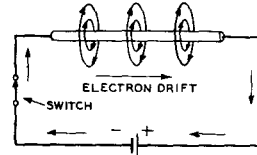

Figure 19
LEFT-HAND RULE

Showing the direction of the magnetic lines of force produced around a conductor carrying an electric current.

and pointing in the direction of electron flow. The fingers then indicate the direction of the magnetic field around the conductor.

Each electron adds its field to the total external magnetic field, so that the greater the number of electrons moving along the conductor, the stronger will be the resulting field.

One of the fundamental laws of magnetism is that *like poles repel one another and unlike poles attract one another*. This is true of current-carrying conductors as well as of permanent magnets. Thus, if two conductors are placed side by side and the current in each is flowing in the same direction, the magnetic fields will also be in the same direction and will combine to form a larger and stronger field. If the current flow in adjacent conductors is in opposite directions, the magnetic fields oppose each other and tend to cancel.

The magnetic field around a conductor may be considerably increased in strength by winding the wire into a coil. The field around each wire then combines with those of the adjacent turns to form a total field through the coil which is concentrated along the axis of the coil and behaves externally in a way similar to the field of a bar magnet.

If the left hand is held so that the thumb is outstretched and parallel to the axis of a coil, with the fingers curled to indicate the direction of electron flow around the turns of the coil, the thumb then points in the direction of the north pole of the magnetic field.

The Magnetic Circuit In the magnetic circuit, the units which correspond to current, voltage, and resistance in the electrical circuit are *flux*, *magneto-motive force*, and *reluctance*.

Flux, Flux Density As a current is made up of a drift of electrons, so is a magnetic field made up of lines of force, and the total number of lines of force in a given magnetic circuit is termed the *flux*. The flux depends upon the material, cross section, and length of the magnetic circuit, and it varies directly as the current flowing in the circuit.

The unit of flux is the *maxwell*, and the symbol is the Greek letter ϕ (phi).

Flux density is the number of lines of force per unit area. It is expressed in *gauss* if the unit of area is the square centimeter (1 gauss = 1 line of force per square centimeter), or in *lines per square inch*. The symbol for flux density is B if it is expressed in gausses, or B if expressed in lines per square inch.

Magnetomotive Force The force which produces a flux in a magnetic circuit is called *magnetomotive force*. It is abbreviated m.m.f. and is designated by the letter F . The unit of magnetomotive force is the *gilbert*, which is equivalent to $1.26 \times NI$, where N is the number of turns and I is the current flowing in the circuit in amperes.

The m.m.f. necessary to produce a given flux density is stated in gilberts per centimeter (oersteds) (H), or in ampere-turns per inch (H).

Reluctance Magnetic reluctance corresponds to electrical resistance, and is the property of a material that opposes the creation of a magnetic flux in the material. It is expressed in *rels*, and the symbol is the letter R . A material has a reluctance of 1 rel when an m.m.f. of 1 ampere-turn (NI) generates a flux of 1 line of force in it. Combinations of reluctances are treated the same as resistances in finding the total effective reluctance. The *specific reluctance* of any substance is its reluctance per unit volume.

Except for iron and its alloys, most common materials have a specific reluctance very nearly the same as that of a vacuum, which, for all practical purposes, may be considered the same as the specific reluctance of air.

Ohm's Law for Magnetic Circuits The relations between flux, magnetomotive force, and reluctance are exactly the same as the relations between current, voltage, and resistance in the electrical circuit. These can be stated as follows:

$$\phi = \frac{F}{R} \quad R = \frac{F}{\phi} \quad F = \phi R$$

where ϕ = flux, F = m.m.f., and R = reluctance.

Permeability Permeability expresses the ease with which a magnetic field may be set up in a material as compared with the effort required in the case of air. Iron, for example, has a permeability of around 2000 times that of air, which means that a given amount of magnetizing effect produced in an iron core by a current flowing through a coil of wire will produce 2000 times the *flux* density that the same magnetizing effect would pro-

duce in air. It may be expressed by the ratio B/H or B/H . In other words,

$$\mu = \frac{B}{H} \quad \text{or} \quad \mu = \frac{B}{H}$$

where μ is the permeability, B is the flux density in gausses, B is the flux density in lines per square inch, H is the m.m.f. in gilberts per centimeter (oersteds), and H is the m.m.f. in ampere-turns per inch. These relations may also be stated as follows:

$$H = \frac{B}{\mu} \quad \text{or} \quad H = \frac{B}{\mu}, \quad \text{and} \quad B = H\mu \quad \text{or} \quad B = H\mu$$

It can be seen from the foregoing that permeability is inversely proportional to the specific reluctance of a material.

Saturation Permeability is similar to *electric conductivity*. There is, however, one important difference: the permeability of magnetic materials is not independent of the magnetic current (flux) flowing through it, although electrical conductivity is substantially independent of the electric current in a wire. When the flux density of a magnetic conductor has been increased to the *saturation point*, a further increase in the magnetizing force will not produce a corresponding increase in flux density.

Calculations To simplify magnetic circuit calculations, a magnetization curve may be drawn for a given unit of material. Such a curve is termed a B-H curve, and may be determined by experiment. When the current in an iron core coil is first applied, the relation between the winding current and the core flux is shown at A-B in figure 20. If the current is then reduced to zero, reversed, brought back again to zero and reversed to the

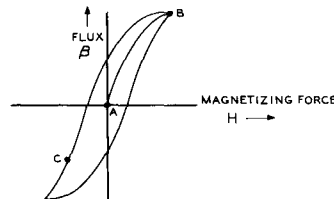

Figure 20
TYPICAL HYSTERESIS LOOP
(B-H CURVE = A-B)

Showing relationship between the current in the winding of an iron core inductor and the core flux. A direct current flowing through the inductance brings the magnetic state of the core to some point on the hysteresis loop, such as C.

original direction, the flux passes through a typical hysteresis loop as shown.

Residual Magnetism; Retentivity The magnetism remaining in a material after the magnetizing force is removed is called *residual magnetism*. *Retentivity* is the property which causes a magnetic material to have residual magnetism after having been magnetized.

Hysteresis; Coercive Force *Hysteresis* is the characteristic of a magnetic system which causes a loss of power due to the fact that a negative magnetizing force must be applied to reduce the residual magnetism to zero. This negative force is termed *coercive force*. By "negative" magnetizing force is meant one which is of the opposite polarity with respect to the original magnetizing force. Hysteresis loss is apparent in transformers and chokes by the heating of the core.

Inductance If the switch shown in figure 19 is opened and closed, a pulsating direct current will be produced. When it is first closed, the current does not instantaneously rise to its maximum value, but builds up to it. While it is building up, the magnetic field is expanding around the conductor. Of course, this happens in a small fraction of a second. If the switch is then opened, the current stops and the magnetic field contracts quickly. This expanding and contracting field will induce a current in any other conductor that is part of a continuous circuit which it cuts. Such a field can be obtained in the way just mentioned by means of a vibrator interruptor, or by applying a.c. to the circuit in place of the battery. Varying the resistance of the circuit will also produce the same effect. This inducing of a current in a conductor due to a varying current in another conductor not in actual contact is called *electromagnetic induction*.

Self-inductance If an alternating current flows through a coil the varying magnetic field around each turn cuts itself and the adjacent turn and induces a voltage in the coil of opposite polarity to the applied e.m.f. The amount of induced voltage depends upon the number of turns in the coil, the current flowing in the coil, and the number of lines of force threading the coil. The voltage so induced is known as a *counter-e.m.f.* or *back-e.m.f.*, and the effect is termed *self-induction*. When the applied voltage is building up, the counter-e.m.f. opposes the rise; when the applied voltage is decreasing, the counter-e.m.f. is of the same polarity and tends to maintain

the current. Thus, it can be seen that self-induction tends to prevent any change in the current in the circuit.

The storage of energy in a magnetic field is expressed in *joules* and is equal to $(LI^2)/2$. (A joule is equal to 1 watt-second. L is defined immediately following.)

The Unit of Inductance; Inductance is usually denoted by the letter L, and is expressed in *The Henry henrys*. A coil has an inductance of 1 henry when a voltage of 1 volt is induced by a current change of 1 ampere per second. The henry, while commonly used in audio frequency circuits, is too large for reference to inductance coils, such as those used in radio frequency circuits; *millihenry* or *microhenry* is more commonly used, in the following manner:

1 henry = 1,000 millihenrys, or 10^3 millihenrys.

1 millihenry = $1/1,000$ of a henry, .001 henry, or 10^{-3} henry.

1 microhenry = $1/1,000,000$ of a henry, or .000001 henry, or 10^{-6} henry.

1 microhenry = $1/1,000$ of a millihenry, .001 or 10^{-3} millihenrys.

1,000 microhenrys = 1 millihenry.

Mutual Inductance When one coil is near another, a varying current in one will produce a varying magnetic field which cuts the turns of the other coil, inducing a current in it. This induced current is also varying, and will therefore induce another current in the first coil. This reaction between two coupled circuits is called *mutual induction*, and can be calculated and expressed in henrys. The symbol for mutual inductance is M. Two circuits thus joined are said to be *inductively coupled*.

The magnitude of the mutual inductance depends upon the shape and size of the two circuits, their positions and distances apart, and the permeability of the medium. The extent to

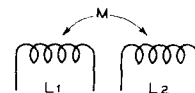

Figure 21
MUTUAL INDUCTANCE

The quantity M represents the mutual inductance between the two coils L₁ and L₂.

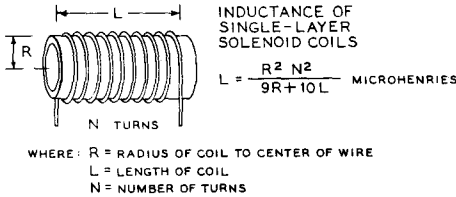

Figure 22
FORMULA FOR
CALCULATING INDUCTANCE

Through the use of the equation and the sketch shown above the inductance of single-layer solenoid coils can be calculated with an accuracy of about one per cent for the types of coils normally used in the h-f and v-h-f range.

which two inductors are coupled is expressed by a relation known as *coefficient of coupling*. This is the ratio of the mutual inductance actually present to the maximum possible value.

The formula for mutual inductance is $L = L_1 + L_2 + 2M$ when the coils are poled so that their fields add. When they are poled so that their fields buck, then $L = L_1 + L_2 - 2M$ (figure 21).

Inductors in Parallel Inductors in parallel are combined exactly as are resistors in parallel, provided that they are far enough apart so that the mutual inductance is entirely negligible.

Inductors in Series Inductors in series are additive, just as are resistors in series, again provided that no mutual inductance exists. In this case, the total inductance L is:

$$L = L_1 + L_2 + \dots \dots \dots \text{etc.}$$

Where mutual inductance does exist:

$$L = L_1 + L_2 + 2M,$$

where M is the mutual inductance.

This latter expression assumes that the coils are connected in such a way that all flux linkages are in the same direction, i.e., additive. If this is not the case and the mutual linkages *subtract* from the self-linkages, the following formula holds:

$$L = L_1 + L_2 - 2M,$$

where M is the mutual inductance.

Core Material Ordinary magnetic cores cannot be used for radio frequencies because the *eddy current and hysteresis losses* in the core material becomes enormous

as the frequency is increased. The principal use for conventional magnetic cores is in the audio-frequency range below approximately 15,000 cycles, whereas at very low frequencies (50 to 60 cycles) their use is mandatory if an appreciable value of inductance is desired.

An air core inductor of only 1 henry inductance would be quite large in size, yet values as high as 500 henrys are commonly available in small iron core chokes. The inductance of a coil with a magnetic core will vary with the amount of current (both a-c and d-c) which passes through the coil. For this reason, iron core chokes that are used in power supplies have a certain inductance rating at a *predetermined value of d-c*.

The permeability of air does not change with flux density; so the inductance of iron core coils often is made less dependent upon flux density by making part of the magnetic path air, instead of utilizing a closed loop of iron. This incorporation of an *air gap* is necessary in many applications of iron core coils, particularly where the coil carries a considerable d-c component. Because the permeability of air is so much lower than that of iron, the air gap need comprise only a small fraction of the magnetic circuit in order to provide a substantial proportion of the total reluctance.

Iron Cored Inductors at Radio Frequencies Iron-core inductors may be used at radio frequencies if the iron is in a very finely divided form, as in the case of the powdered iron cores used in some types of r-f coils and i-f transformers. These cores are made of extremely small particles of iron. The particles are treated with an insulating material so that each particle will be insulated from the others, and the treated powder is molded with a binder into cores. Eddy current losses are greatly reduced, with the result that these special iron cores are entirely practical in circuits which operate up to 100 Mc. in frequency.

2-5 RC and RL Transients

A voltage divider may be constructed as shown in figure 23. Kirchhoff's and Ohm's Laws hold for such a divider. This circuit is known as an RC circuit.

Time Constant When switch S in figure 23 is placed in position 1, a voltmeter across capacitor C will indicate the manner in which the capacitor will become charged through the resistor R from battery B . If relatively large values are used for R and C , and if a v-t voltmeter which draws negligible current is used

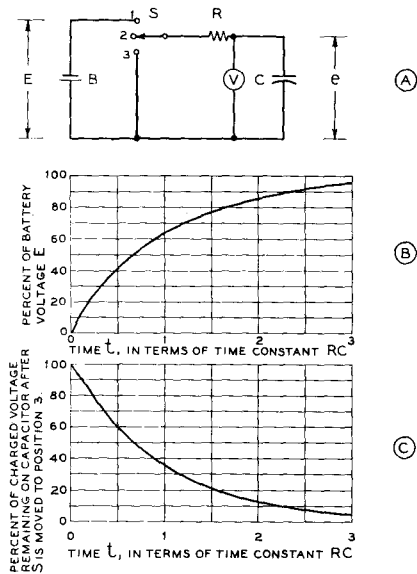

Figure 23
TIME CONSTANT OF AN R-C CIRCUIT

Shown at (A) is the circuit upon which is based the curves of (B) and (C). (B) shows the rate at which capacitor C will charge from the instant at which switch S is placed in position 1. (C) shows the discharge curve of capacitor C from the instant at which switch S is placed in position 3.

to measure the voltage e , the rate of charge of the capacitor may actually be plotted with the aid of a stop watch.

Voltage Gradient It will be found that the voltage e will begin to rise rapidly from zero the instant the switch is closed. Then, as the capacitor begins to charge, the rate of change of voltage across the capacitor will be found to decrease, the charging taking place more and more slowly as the capacitor voltage e approaches the battery voltage E . Actually, it will be found that in any given interval a constant percentage of the remaining difference between e and E will be delivered to the capacitor as an increase in voltage. A voltage which changes in this manner is said to increase *logarithmically*, or is said to follow an *exponential* curve.

Time Constant A mathematical analysis of the charging of a capacitor in this manner would show that the relationship between the battery voltage E and the voltage across the capacitor e could be expressed in the following manner:

$$e = E (1 - e^{-t/RC})$$

where $e, E, R,$ and C have the values discussed above, $e = 2.716$ (the base of Napierian or natural logarithms), and t represents the time which has elapsed since the closing of the switch. With t expressed in seconds, R and C

Figure 24
TYPICAL INDUCTANCES

The large inductance is a 1000-watt transmitting coil. To the right and left of this coil are small r-f chokes. Several varieties of low power capability coils are shown below, along with various types of r-f chokes intended for high-frequency operation.

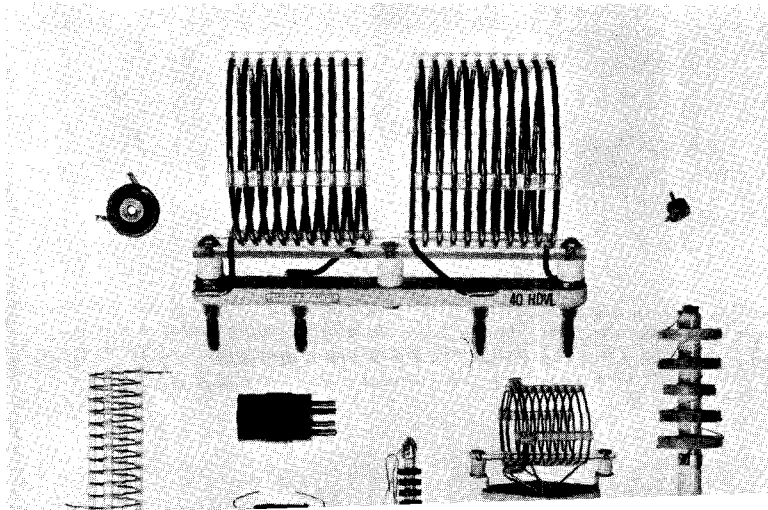

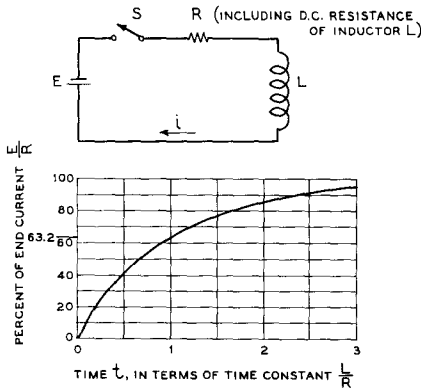

Figure 25

TIME CONSTANT OF AN R-L CIRCUIT

Note that the time constant for the increase in current through an R-L circuit is identical to the rate of increase in voltage across the capacitor in an R-C circuit.

may be expressed in farads and ohms, or R and C may be expressed in microfarads and megohms. The product RC is called the *time constant* of the circuit, and is expressed in seconds. As an example, if R is one megohm and C is one microfarad, the time constant RC will be equal to the product of the two, or one second.

When the elapsed time t is equal to the time constant of the RC network under consideration, the exponent of ϵ becomes -1 . Now ϵ^{-1} is equal to $1/\epsilon$, or $1/2.716$, which is 0.368. The quantity $(1 - 0.368)$ then is equal to 0.632. Expressed as percentage, the above

means that the voltage across the capacitor will have increased to 63.2 per cent of the battery voltage in an interval equal to the time constant or RC product of the circuit. Then, during the next period equal to the time constant of the RC combination, the voltage across the capacitor will have risen to 63.2 per cent of the remaining difference in voltage, or 86.5 per cent of the applied voltage E.

RL Circuit In the case of a series combination of a resistor and an inductor, as shown in figure 25, the current through the combination follows a very similar law to that given above for the voltage appearing across the capacitor in an RC series circuit. The equation for the current through the combination is:

$$i = \frac{E}{R} (1 - \epsilon^{-tR/L})$$

where i represents the current at any instant through the series circuit, E represents the applied voltage, and R represents the total resistance of the resistor and the d-c resistance of the inductor in series. Thus the time constant of the RL circuit is L/R , with R expressed in ohms and L expressed in henrys.

Voltage Decay When the switch in figure 23 is moved to position 3 after the capacitor has been charged, the capacitor voltage will drop in the manner shown in figure 23-C. In this case the voltage across the capacitor will decrease to 36.8 per cent of the initial voltage (will make 63.2 per cent of the total drop) in a period of time equal to the time constant of the RC circuit.

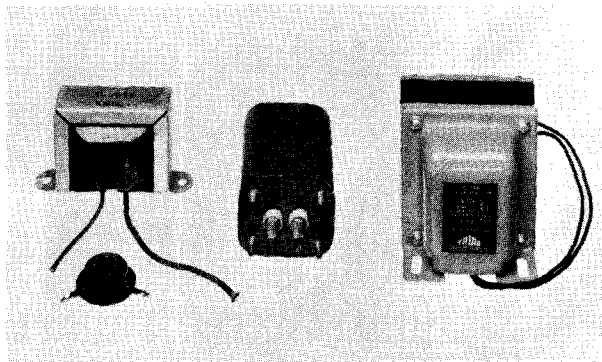

TYPICAL IRON-CORE INDUCTANCES

At the right is an upright mounting filter choke intended for use in low powered transmitters and audio equipment. At the center is a hermetically sealed inductance for use under poor environmental conditions. To the left is an inexpensive receiving-type choke, with a small iron-core r-f choke directly in front of it.

Alternating Current Circuits

The previous chapter has been devoted to a discussion of circuits and circuit elements upon which is impressed a current consisting of a flow of electrons in one direction. This type of unidirectional current flow is called direct current, abbreviated *d.c.* Equally as important in radio and communications work, and power practice, is a type of current flow whose direction of electron flow reverses periodically. The reversal of flow may take place at a low rate, in the case of power systems, or it may take place millions of times per second in the case of communications frequencies. This type of current flow is called *alternating current*, abbreviated *a.c.*

3-1 Alternating Current

Frequency of an Alternating Current An alternating current is one whose amplitude of current flow periodically rises from zero to a maximum in one direction, decreases to zero, changes its direction, rises to maximum in the opposite direction, and decreases to zero again. This complete process, starting from zero, passing through two maximums in opposite directions, and returning to zero again, is called a *cycle*. The number of times per second that a current passes through the complete cycle is called the *frequency* of the current. One and one quarter cycles of an alternating current wave are illustrated diagrammatically in figure 1.

Frequency Spectrum At present the usable frequency range for alternating electrical currents extends over the enormous frequency range from about 15 cycles per second to perhaps 30,000,000,000 cycles per second. It is obviously cumbersome to use a frequency designation in c.p.s. for enormously high frequencies, so three common units which are multiples of one cycle per second have been established.

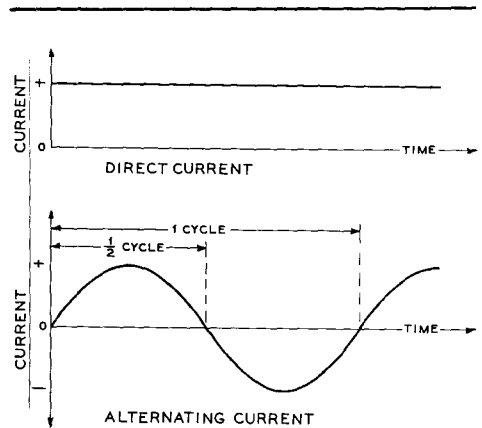

Figure 1
ALTERNATING CURRENT
AND DIRECT CURRENT

Graphical comparison between unidirectional (direct) current and alternating current as plotted against time.

These units are:

- (1) the kilocycle (abbr., kc.), 1000 c.p.s.
- (2) the Megacycle (abbr., Mc.), 1,000,000 c.p.s. or 1000 kc.
- (3) the kilo-Megacycle (abbr., kMc.), 1,000,000,000 c.p.s. or 1000 Mc.

With easily handled units such as these we can classify the entire usable frequency range into frequency bands.

The frequencies falling between about 15 and 20,000 c.p.s. are called *audio* frequencies, abbreviated *a.f.*, since these frequencies are audible to the human ear when converted from electrical to acoustical signals by a loud-speaker or headphone. Frequencies in the vicinity of 60 c.p.s. also are called *power* frequencies, since they are commonly used to distribute electrical power to the consumer.

The frequencies falling between 10,000 c.p.s. (10 kc.) and 30,000,000,000 c.p.s. (30 kMc.) are commonly called *radio* frequencies, abbreviated *r.f.*, since they are commonly used in radio communication and allied arts. The radio-frequency spectrum is often arbitrarily classified into seven frequency bands, each one of which is ten times as high in frequency as the one just below it in the spectrum (except for the v-l-f band at the bottom end of the spectrum). The present spectrum, with classifications, is given below.

Frequency	Classification	Abbrev.
10 to 30 kc.	Very-low frequencies	v.l.f
30 to 300 kc.	Low frequencies	l.f.
300 to 3000 kc.	Medium frequencies	m.f.
3 to 30 Mc.	High frequencies	h.f.
30 to 300 Mc.	Very-high frequencies	v.h.f.
300 to 3000 Mc.	Ultra-high frequencies	u.h.f.
3 to 30 kMc.	Super-high frequencies	s.h.f.
30 to 300 kMc.	Extremely-high frequencies	e.h.f.

Generation of Alternating Current Faraday discovered that if a conductor which forms part of a closed circuit is moved through a magnetic field so as to cut across the lines of force, a current will flow in the conductor. He also discovered that, if a conductor in a second closed circuit is brought near the first conductor and the current in the first one is varied, a current will flow in the second conductor. This effect is known as *induction*, and the currents so generated are *induced currents*. In the latter case it is the lines of force which are moving and cutting the second conductor, due to the varying current strength in the first conductor.

A current is induced in a conductor if there is a relative motion between the conductor and a magnetic field, its direction of flow depending upon the direction of the relative

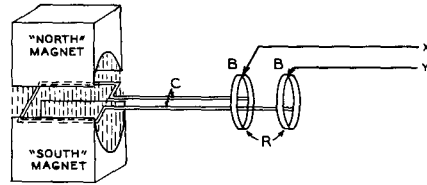

Figure 2
THE ALTERNATOR

Semi-schematic representation of the simplest form of the alternator.

motion between the conductor and the field, and its strength depends upon the intensity of the field, the rate of cutting lines of force, and the number of turns in the conductor.

Alternators A machine that generates an alternating current is called an *alternator* or *a-c* generator. Such a machine in its basic form is shown in figure 2. It consists of two permanent magnets, M, the opposite poles of which face each other and are machined so that they have a common radius. Between these two poles, north (N) and south (S), a substantially constant magnetic field exists. If a conductor in the form of C is suspended so that it can be freely rotated between the two poles, and if the opposite ends of conductor C are brought to collector rings, there will be a flow of alternating current when conductor C is rotated. This current will flow out through the collector rings R and brushes B to the external circuit, X-Y.

The field intensity between the two pole pieces is substantially constant over the entire area of the pole face. However, when the conductor is moving parallel to the lines of force at the top or bottom of the pole faces, no lines are being cut. As the conductor moves on across the pole face it cuts more and more lines of force for each unit distance of travel, until it is cutting the maximum number of lines when opposite the center of the pole. Therefore, zero current is induced in the conductor at the instant it is midway between the two poles, and maximum current is induced when it is opposite the center of the pole face. After the conductor has rotated through 180° it can be seen that its position with respect to the pole pieces will be exactly opposite to that when it started. Hence, the second 180° of rotation will produce an alternation of current in the opposite direction to that of the first alternation.

The current does *not* increase directly as the angle of rotation, but rather as the *sine* of the angle; hence, such a current has the mathematical form of a *sine wave*. Although

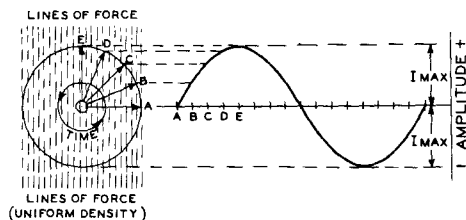

Figure 3
OUTPUT OF THE ALTERNATOR
 Graph showing sine-wave output current of the alternator of figure 2.

most electrical machinery does not produce a strictly pure sine curve, the departures are usually so slight that the assumption can be regarded as fact for most practical purposes. All that has been said in the foregoing paragraphs concerning alternating current also is applicable to alternating voltage.

The rotating arrow to the left in figure 3 represents a conductor rotating in a constant magnetic field of uniform density. The arrow also can be taken as a *vector* representing the strength of the magnetic field. This means that the length of the arrow is determined by the strength of the field (number of lines of force), which is constant. Now if the arrow is rotating at a constant rate (that is, with constant *angular velocity*), then the voltage developed across the conductor will be proportional to the rate at which it is cutting lines of force, which rate is proportional to the vertical distance between the tip of the arrow and the horizontal base line.

If EO is taken as unity or a voltage of 1, then the voltage (vertical distance from tip of arrow to the horizontal base line) at point C for instance may be determined simply by referring to a table of sines and looking up the sine of the angle which the arrow makes with the horizontal.

When the arrow has traveled from A to point E, it has traveled 90 degrees or one quarter cycle. The other three quadrants are not shown because their complementary or mirror relationship to the first quadrant is obvious.

It is important to note that time units are represented by *degrees* or quadrants. The fact that AB, BC, CD, and DE are equal chords (forming equal quadrants) simply means that the arrow (conductor or vector) is traveling at a constant speed, because these points on the radius represent the passage of equal units of time.

The whole picture can be represented in another way, and its derivation from the foregoing is shown in figure 3. The time base is represented by a straight line rather than by

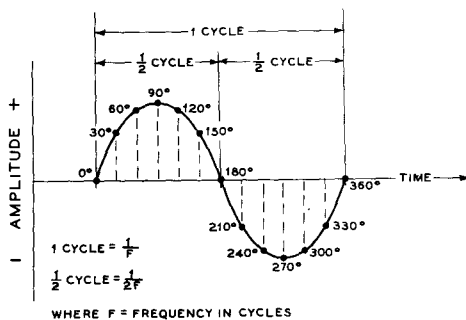

Figure 4
THE SINE WAVE

Illustrating one cycle of a sine wave. One complete cycle of alternation is broken up into 360 degrees. Then one-half cycle is 180 degrees, one-quarter cycle is 90 degrees, and so on down to the smallest division of the wave. A cosine wave has a shape identical to a sine wave but is shifted 90 degrees in phase — in other words the wave begins at full amplitude, the 90-degree point comes at zero amplitude, the 180-degree point comes at full amplitude in the opposite direction of current flow, etc.

angular rotation. Points A, B, C, etc., represent the same units of time as before. When the voltage corresponding to each point is projected to the corresponding time unit, the familiar *sine curve* is the result.

The frequency of the generated voltage is proportional to the speed of rotation of the alternator, and to the number of magnetic poles in the field. Alternators may be built to produce radio frequencies up to 30 kilocycles, and some such machines are still used for low frequency communication purposes. By means of multiple windings, three-phase output may be obtained from large industrial alternators.

Radian Notation From figure 1 we see that the value of an a-c wave varies continuously. It is often of importance to know the amplitude of the wave in terms of the total amplitude at any instant or at any time within the cycle. To be able to establish the instant in question we must be able to divide the cycle into parts. We could divide the cycle into eighths, hundredths, or any other ratio that suited our fancy. However, it is much more convenient mathematically to divide the cycle either into *electrical degrees* (360° represent one cycle) or into *radians*. A radian is an arc of a circle equal to the radius of the circle; hence there are 2π radians per cycle — or per circle (since there are π diameters per circumference, there are 2π radii).

Both radian notation and electrical degree

notation are used in discussions of alternating current circuits. However, trigonometric tables are much more readily available in terms of degrees than radians, so the following simple conversions are useful.

$$2\pi \text{ radians} = 1 \text{ cycle} = 360^\circ$$

$$\pi \text{ radians} = \frac{1}{2} \text{ cycle} = 180^\circ$$

$$\frac{\pi}{2} \text{ radians} = \frac{1}{4} \text{ cycle} = 90^\circ$$

$$\frac{\pi}{3} \text{ radians} = \frac{1}{6} \text{ cycle} = 60^\circ$$

$$\frac{\pi}{4} \text{ radians} = \frac{1}{8} \text{ cycle} = 45^\circ$$

$$1 \text{ radian} = \frac{1}{2\pi} \text{ cycle} = 57.3^\circ$$

When the conductor in the simple alternator of figure 2 has made one complete revolution it has generated one cycle and has rotated through 2π radians. The expression $2\pi f$ then represents the number of radians in one cycle multiplied by the number of cycles per second (the frequency) of the alternating voltage or current. The expression then represents the number of radians per second through which the conductor has rotated. Hence $2\pi f$ represents the angular velocity of the rotating conductor, or of the rotating vector which represents any alternating current or voltage, expressed in radians per second.

In technical literature the expression $2\pi f$ is often replaced by ω , the lower-case Greek letter *omega*. Velocity multiplied by time gives the distance travelled, so $2\pi ft$ (or ωt) represents the angular distance through which the rotating conductor or the rotating vector has travelled since the reference time $t = 0$. In the case of a sine wave the reference time $t = 0$ represents that instant when the voltage or the current, whichever is under discussion, also is equal to zero.

Instantaneous Value of Voltage or Current The instantaneous voltage or current is proportional to the sine of the angle through which the rotating vector has travelled since reference time $t = 0$. Hence, when the peak value of the a-c wave amplitude (either voltage or current amplitude) is known, and the angle through which the rotating vector has travelled is established, the amplitude of the wave at this instant can be determined through use of the following expression:

$$e = E_{\max} \sin 2\pi ft,$$

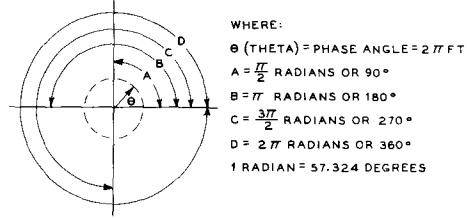

Figure 5
ILLUSTRATING RADIAN NOTATION

The radian is a unit of phase angle, equal to 57.324 degrees. It is commonly used in mathematical relationships involving phase angles since such relationships are simplified when radian notation is used.

where e = the instantaneous voltage

E = maximum crest value of voltage,

f = frequency in cycles per second, and

t = period of time which has elapsed since $t = 0$ expressed as a fraction of one second.

The instantaneous current can be found from the same expression by substituting i for e and I_{\max} for E_{\max} .

It is often easier to visualize the process of determining the instantaneous amplitude by ignoring the frequency and considering only one cycle of the a-c wave. In this case, for a sine wave, the expression becomes:

$$e = E_{\max} \sin \theta$$

where θ represents the angle through which the vector has rotated since time (and amplitude) were zero. As examples:

when $\theta = 30^\circ$
 $\sin \theta = 0.5$
 so $e = 0.5 E_{\max}$

when $\theta = 60^\circ$
 $\sin \theta = 0.866$
 so $e = 0.866 E_{\max}$

when $\theta = 90^\circ$
 $\sin \theta = 1.0$
 so $e = E_{\max}$

when $\theta = 1$ radian
 $\sin \theta = 0.8415$
 so $e = 0.8415 E_{\max}$

Effective Value of an Alternating Current The instantaneous value of an alternating current or voltage varies continuously throughout the cycle.

So some value of an a-c wave must be chosen to establish a relationship between the effectiveness of an a-c and a d-c voltage or current. The heating value of an alternating current has been chosen to establish the reference between the *effective* values of a.c. and d.c. Thus an alternating current will have an effective value of 1 ampere when it produces the same heat in a resistor as does 1 ampere of direct current.

The effective value is derived by taking the instantaneous values of current over a cycle of alternating current, squaring these values, taking an average of the squares, and then taking the square root of the average. By this procedure, the effective value becomes known as the *root mean square* or r.m.s. value. This is the value that is read on a-c voltmeters and a-c ammeters. The r.m.s. value is 70.7 (for sine waves only) per cent of the peak or maximum instantaneous value and is expressed as follows:

$$E_{eff.} \text{ or } E_{r.m.s.} = 0.707 \times E_{max} \text{ or}$$

$$I_{eff.} \text{ or } I_{r.m.s.} = 0.707 \times I_{max}.$$

The following relations are extremely useful in radio and power work:

$$E_{r.m.s.} = 0.707 \times E_{max}, \text{ and}$$

$$E_{max} = 1.414 \times E_{r.m.s.}$$

Rectified Alternating Current or Pulsating Direct Current If an alternating current is passed through a rectifier, it emerges in the form of a current of *varying amplitude* which flows in *one direction* only. Such a current is known as *rectified a.c.* or *pulsating d.c.* A typical wave form of a pulsating direct current as would be obtained from the output of a full-wave rectifier is shown in figure 6.

Measuring instruments designed for d-c operation will not read the peak for instantaneous maximum value of the pulsating d-c output from the rectifier; they will read only the *average value*. This can be explained by assuming that it could be possible to cut off some of the peaks of the waves, using the cut-off portions to fill in the spaces that are open, thereby obtaining an *average* d-c value. A milliammeter and voltmeter connected to the adjoining circuit, or across the output of the rectifier, will read this average value. It is related to *peak* value by the following expression:

$$E_{avg} = 0.636 \times E_{max}$$

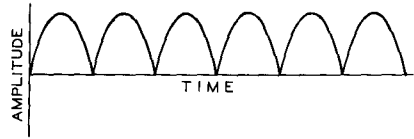

Figure 6
FULL-WAVE RECTIFIED
SINE WAVE

Waveform obtained at the output of a fullwave rectifier being fed with a sine wave and having 100 per cent rectification efficiency. Each pulse has the same shape as one-half cycle of a sine wave. This type of current is known as pulsating direct current.

It is thus seen that the average value is 63.6 per cent of the peak value.

Relationship Between Peak, R.M.S. or Effective, and Average Values To summarize the three most significant values of an a-c sine wave: the peak value is equal to 1.41 times the r.m.s. or effective, and the r.m.s. value is equal to 0.707 times the peak value; the average value of a full-wave rectified a-c wave is 0.636 times the peak value, and the average value of a rectified wave is equal to 0.9 times the r.m.s. value.

$$\begin{aligned} \text{R.M.S.} &= 0.707 \times \text{Peak} \\ \text{Average} &= 0.636 \times \text{Peak} \end{aligned}$$

.....

$$\begin{aligned} \text{Average} &= 0.9 \times \text{R.M.S.} \\ \text{R.M.S.} &= 1.11 \times \text{Average} \end{aligned}$$

.....

$$\begin{aligned} \text{Peak} &= 1.414 \times \text{R.M.S.} \\ \text{Peak} &= 1.57 \times \text{Average} \end{aligned}$$

Applying Ohm's Law to Alternating Current Ohm's law applies equally to direct or alternating current, *provided* the circuits under consideration are purely resistive, that is, circuits which have neither inductance (coils) nor capacitance (capacitors). Problems which involve tube filaments, drop resistors, electric lamps, heaters or similar resistive devices can be solved from Ohm's law, regardless of whether the current is direct or alternating. When a capacitor or coil is made a part of the circuit, a property common to either, called *reactance*, must be taken into consideration. Ohm's law still applies to a-c circuits containing reactance, but additional considerations are involved; these will be discussed in a later paragraph.

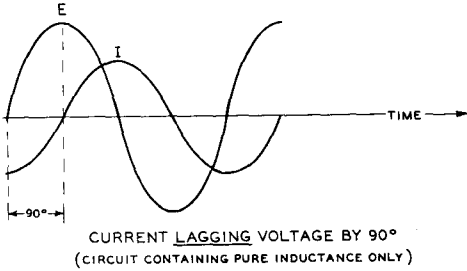

Figure 7
LAGGING PHASE ANGLE

Showing the manner in which the current lags the voltage in an a-c circuit containing pure inductance only. The lag is equal to one-quarter cycle or 90 degrees.

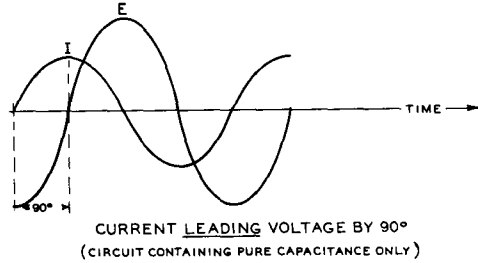

Figure 8
LEADING PHASE ANGLE

Showing the manner in which the current leads the voltage in an a-c circuit containing pure capacitance only. The lead is equal to one-quarter cycle or 90 degrees.

Inductive Reactance As was stated in Chapter Two, when a changing current flows through an inductor a back- or counter-electromotive force is developed; opposing any change in the initial current. This property of an inductor causes it to offer opposition or *impedance* to a change in current. The measure of impedance offered by an inductor to an alternating current of a given frequency is known as its *inductive reactance*. This is expressed as X_L .

$$X_L = 2\pi fL,$$

where X_L = inductive reactance expressed in ohms.

$$\begin{aligned} \pi &= 3.1416 \quad (2\pi = 6.283), \\ f &= \text{frequency in cycles,} \\ L &= \text{inductance in henrys.} \end{aligned}$$

Inductive Reactance at Radio Frequencies It is very often necessary to compute inductive reactance at radio frequencies. The same formula may be used, but to make it less cumbersome the inductance is expressed in *millihenrys* and the frequency in *kilocycles*. For higher frequencies and smaller values of inductance, frequency is expressed in *megacycles* and inductance in *microhenrys*. The basic equation need not be changed, since the multiplying factors for inductance and frequency appear in numerator and denominator, and hence are cancelled out. However, it is not possible in the same equation to express L in millihenrys and f in cycles without conversion factors.

Capacitive Reactance It has been explained that inductive reactance is the measure of the ability of an inductor to offer impedance to the flow of an alternating current.

Capacitors have a similar property although in this case the opposition is to any change in the voltage across the capacitor. This property is called *capacitive reactance* and is expressed as follows:

$$X_C = \frac{1}{2\pi fC},$$

where X_C = capacitive reactance in ohms,
 $\pi = 3.1416$
 f = frequency in cycles,
 C = capacitance in farads.

Capacitive Reactance at Radio Frequencies Here again, as in the case of inductive reactance, the units of capacitance and frequency can be converted into smaller units for practical problems encountered in radio work. The equation may be written:

$$X_C = \frac{1,000,000}{2\pi fC},$$

where f = frequency in megacycles,
 C = capacitance in micro-microfarads.

In the audio range it is often convenient to express frequency (f) in *cycles* and capacitance (C) in *microfarads*, in which event the same formula applies.

Phase When an alternating current flows through a purely resistive circuit, it will be found that the current will go through maximum and minimum in perfect step with the voltage. In this case the current is said to be in step or *in phase* with the voltage. For this reason, Ohm's law will apply equally well for a. c. or d. c. where pure resistances are concerned, provided that the same values of the

wave (either peak or r.m.s.) for both voltage and current are used in the calculations.

However, in calculations involving alternating currents the voltage and current are not necessarily in phase. The current through the circuit may lag behind the voltage, in which case the current is said to have *lagging* phase. Lagging phase is caused by inductive reactance. If the current reaches its maximum value ahead of the voltage (figure 8) the current is said to have a *leading* phase. A leading phase angle is caused by capacitive reactance.

In an electrical circuit containing reactance only, the current will either lead or lag the voltage by 90° . If the circuit contains inductive reactance only, the current will lag the voltage by 90° . If only capacitive reactance is in the circuit, the current will lead the voltage by 90° .

Reactances in Combination Inductive and capacitive reactance have exactly opposite effects on the phase relation between current and voltage in a circuit. Hence when they are used in combination their effects tend to neutralize. The combined effect of a capacitive and an inductive reactance is often called the *net reactance* of a circuit. The net reactance (X) is found by subtracting the capacitive reactance from the inductive reactance, $X = X_L - X_C$.

The result of such a combination of pure reactances may be either positive, in which case the positive reactance is greater so that the net reactance is inductive, or it may be negative in which case the capacitive reactance is greater so that the net reactance is capacitive. The net reactance may also be zero in which case the circuit is said to be *resonant*. The condition of resonance will be discussed in a later section. Note that inductive reactance is always taken as being positive while capacitive reactance is always taken as being negative.

Impedance; Circuits Containing Reactance and Resistance Pure reactances introduce a phase angle of 90° between voltage and current; pure resistance introduces no phase shift between voltage and current. Hence we cannot add a reactance and a resistance directly. When a reactance and a resistance are used in combination the resulting phase angle of current flow with respect to the impressed voltage lies somewhere between plus or minus 90° and 0° depending upon the relative magnitudes of the reactance and the resistance.

The term *impedance* is a general term which can be applied to any electrical entity which impedes the flow of current. Hence the term may be used to designate a resistance, a pure

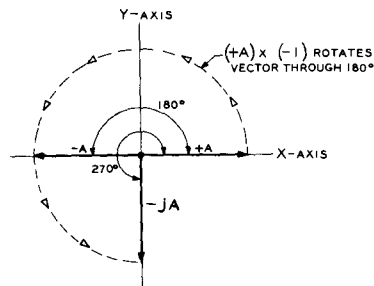

Figure 9

Operation on the vector (+A) by the quantity (-1) causes vector to rotate through 180 degrees.

reactance, or a complex combination of both reactance and resistance. The designation for impedance is Z. An impedance must be defined in such a manner that both its magnitude and its phase angle are established. The designation may be accomplished in either of two ways — one of which is convertible into the other by simple mathematical operations.

The "j" Operator The first method of designating an impedance is actually to specify both the resistive and the reactive component in the form $R + jX$. In this form R represents the resistive component in ohms and X represents the reactive component. The "j" merely means that the X component is reactive and thus cannot be added directly to the R component. Plus jX means that the reactance is positive or inductive, while if minus jX were given it would mean that the reactive component was negative or capacitive.

In figure 9 we have a vector (+A) lying along the positive X-axis of the usual X-Y coordinate system. If this vector is multiplied by the quantity (-1), it becomes (-A) and its position now lies along the X-axis in the negative direction. The operator (-1) has caused the vector to rotate through an angle of 180 degrees. Since (-1) is equal to $(\sqrt{-1} \times \sqrt{-1})$, the same result may be obtained by operating on the vector with the operator $(\sqrt{-1} \times \sqrt{-1})$. However if the vector is operated on but once by the operator $(\sqrt{-1})$, it is caused to rotate only 90 degrees (figure 10). Thus the operator $(\sqrt{-1})$ rotates a vector by 90 degrees. For convenience, this operator is called the *j operator*. In like fashion, the operator (-j) rotates the vector of figure 9 through an angle of 270 degrees, so that the resulting vector (-jA) falls on the (-Y) axis of the coordinate system.

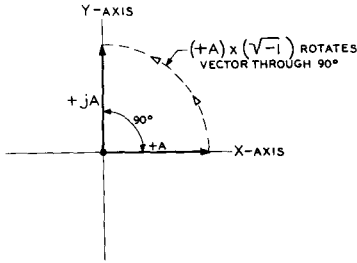

Figure 10

Operation on the vector (+A) by the quantity (j) causes vector to rotate through 90 degrees.

Polar Notation The second method of representing an impedance is to specify its absolute magnitude and the phase angle of current with respect to voltage, in the form $Z \angle \theta$. Figure 11 shows graphically the relationship between the two common ways of representing an impedance.

The construction of figure 11 is called an impedance diagram. Through the use of such a diagram we can add graphically a resistance and a reactance to obtain a value for the resulting impedance in the scalar form. With zero at the origin, resistances are plotted to the right, positive values of reactance (inductive) in the upward direction, and negative values of reactance (capacitive) in the downward direction.

Note that the resistance and reactance are drawn as the two sides of a right triangle, with the hypotenuse representing the resulting impedance. Hence it is possible to determine mathematically the value of a resultant impedance through the familiar right-triangle relationship—the square of the hypotenuse is equal to the sum of the squares of the other two sides:

$$Z^2 = R^2 + X^2$$

$$\text{or } |Z| = \sqrt{R^2 + X^2}$$

Note also that the angle θ included between R and Z can be determined from any of the following trigonometric relationships:

$$\sin \theta = \frac{X}{|Z|}$$

$$\cos \theta = \frac{R}{|Z|}$$

$$\tan \theta = \frac{X}{R}$$

One common problem is that of determining the scalar magnitude of the impedance, $|Z|$,

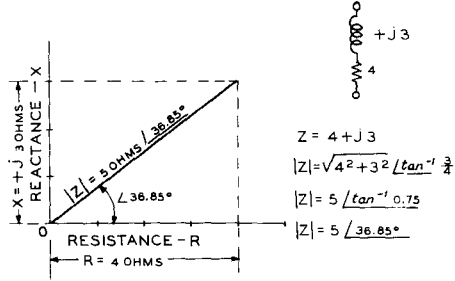

Figure 11

THE IMPEDANCE TRIANGLE

Showing the graphical construction of a triangle for obtaining the net (scalar) impedance resulting from the connection of a resistance and a reactance in series. Shown also alongside is the alternative mathematical procedure for obtaining the values associated with the triangle.

and the phase angle θ , when resistance and reactance are known; hence, of converting from the $Z = R + jX$ to the $|Z| \angle \theta$ form. In this case we use two of the expressions just given:

$$|Z| = \sqrt{R^2 + X^2}$$

$$\tan \theta = \frac{X}{R}, \text{ (or } \theta = \tan^{-1} \frac{X}{R} \text{)}$$

The inverse problem, that of converting from the $|Z| \angle \theta$ to the $R + jX$ form is done with the following relationships, both of which are obtainable by simple division from the trigonometric expressions just given for determining the angle θ :

$$R = |Z| \cos \theta$$

$$jX = |Z| j \sin \theta$$

By simple addition these two expressions may be combined to give the relationship between the two most common methods of indicating an impedance:

$$R + jX = |Z| (\cos \theta + j \sin \theta)$$

In the case of impedance, resistance, or reactance, the unit of measurement is the ohm; hence, the ohm may be thought of as a unit of opposition to current flow, without reference to the relative phase angle between the applied voltage and the current which flows.

Further, since both capacitive and inductive reactance are functions of frequency, impedance will vary with frequency. Figure 12 shows the manner in which $|Z|$ will vary with frequency in an RL series circuit and in an RC series circuit.

Series RLC Circuits In a series circuit containing R, L, and C, the im-

pedance is determined as discussed before except that the reactive component in the expressions becomes: (The net reactance—the difference between X_L and X_C .) Hence $(X_L - X_C)$ may be substituted for X in the equations. Thus:

$$|Z| = \sqrt{R^2 + (X_L - X_C)^2}$$

$$\theta = \tan^{-1} \frac{(X_L - X_C)}{R}$$

A series RLC circuit thus may present an impedance which is capacitively reactive if the net reactance is capacitive, inductively reactive if the net reactance is inductive, or resistive if the capacitive and inductive reactances are equal.

Addition of Complex Quantities The addition of complex quantities (for example, impedances in series) is quite simple if the quantities are in the rectangular form. If they are in the polar form they only can be added graphically, unless they are converted to the rectangular form by the relationships previously given. As an example of the addition of complex quantities in the rectangular form, the equation for the addition of impedances is:

$$(R_1 + jX_1) + (R_2 + jX_2) = (R_1 + R_2) + j(X_1 + X_2)$$

For example if we wish to add the impedances $(10 + j50)$ and $(20 - j30)$ we obtain:

$$\begin{aligned} (10 + j50) + (20 - j30) \\ = (10 + 20) + j(50 + (-30)) \\ = 30 + j(50 - 30) \\ = 30 + j20 \end{aligned}$$

Multiplication and Division of Complex Quantities It is often necessary in solving certain types of circuits to multiply or divide two complex quantities. It is a much simpler mathematical operation to multiply or divide complex quantities if they are expressed in the polar form. Hence if they are given in the rectangular form they should be converted to the polar form before multiplication or division is begun. Then the multiplication is accomplished by multiplying the $|Z|$ terms together and adding algebraically the $\angle \theta$ terms, as:

$$(|Z_1| \angle \theta_1) (|Z_2| \angle \theta_2) = |Z_1| |Z_2| (\angle \theta_1 + \angle \theta_2)$$

For example, suppose that the two impedances $|20| \angle 43^\circ$ and $|32| \angle -23^\circ$ are to be multiplied. Then:

$$\begin{aligned} (|20| \angle 43^\circ) (|32| \angle -23^\circ) &= |20 \cdot 32| \\ &(\angle 43^\circ + \angle -23^\circ) \\ &= 640 \angle 20^\circ \end{aligned}$$

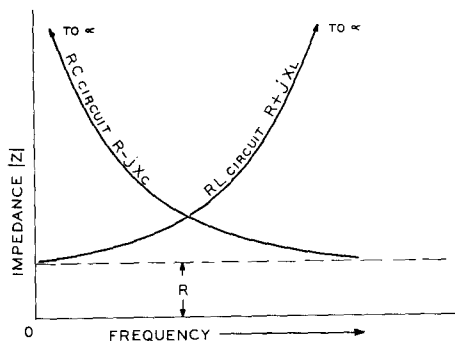

Figure 12
IMPEDANCE AGAINST FREQUENCY
FOR R-L AND R-C CIRCUITS

The impedance of an R-C circuit approaches infinity as the frequency approaches zero (d.c.), while the impedance of a series R-L circuit approaches infinity as the frequency approaches infinity. The impedance of an R-C circuit approaches the impedance of the series resistor as the frequency approaches infinity, while the impedance of a series R-L circuit approaches the impedance of the resistor as the frequency approaches zero.

Division is accomplished by dividing the denominator into the numerator, and subtracting the angle of the denominator from that of the numerator, as:

$$\frac{|Z_1| \angle \theta_1}{|Z_2| \angle \theta_2} = \frac{|Z_1|}{|Z_2|} (\angle \theta_1 - \angle \theta_2)$$

For example, suppose that an impedance of $|50| \angle 67^\circ$ is to be divided by an impedance of $|10| \angle 45^\circ$. Then:

$$\frac{|50| \angle 67^\circ}{|10| \angle 45^\circ} = \frac{|50|}{|10|} (\angle 67^\circ - \angle 45^\circ) = |5| (\angle 22^\circ)$$

Ohm's Law for Complex Quantities The simple form of Ohm's Law used for d-c circuits may be stated in a more general form for application to a-c circuits involving either complex quantities or simple resistive elements. The form is:

$$I = \frac{E}{Z}$$

in which, in the general case, I , E , and Z are complex (vector) quantities. In the simple case where the impedance is a pure resistance with an a-c voltage applied, the equation simplifies to the familiar $I = E/R$. In any case the applied voltage may be expressed either as peak, r.m.s., or average; the resulting

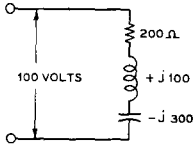

Figure 13
SERIES R-L-C CIRCUIT

current always will be in the same type of units as used to define the voltage.

In the more general case vector algebra must be used to solve the equation. And, since either division or multiplication is involved, the complex quantities should be expressed in the polar form. As an example, take the case of the series circuit shown in figure 13 with 100 volts applied. The impedance of the series circuit can best be obtained first in the rectangular form, as:

$$200 + j(100 - 300) = 200 - j200$$

Now, to obtain the current we must convert this impedance to the polar form.

$$\begin{aligned} |Z| &= \sqrt{200^2 + (-200)^2} \\ &= \sqrt{40,000 + 40,000} \\ &= \sqrt{80,000} \\ &= 282 \Omega \end{aligned}$$

$$\begin{aligned} \theta &= \tan^{-1} \frac{X}{R} = \tan^{-1} \frac{-200}{200} = \tan^{-1} -1 \\ &= -45^\circ. \end{aligned}$$

Therefore $Z = 282 \angle -45^\circ$

Note that in a series circuit the resulting impedance takes the sign of the largest reactance in the series combination.

Where a slide-rule is being used to make the computations, the impedance may be found without any addition or subtraction operations by finding the angle θ first, and then using the trigonometric equation below for obtaining the impedance. Thus:

$$\begin{aligned} \theta &= \tan^{-1} \frac{X}{R} = \tan^{-1} \frac{-200}{200} = \tan^{-1} -1 \\ &= -45^\circ \end{aligned}$$

$$\text{Then } |Z| = \frac{R}{\cos \theta} \cos -45^\circ = 0.707$$

$$|Z| = \frac{200}{0.707} = 282 \Omega$$

Since the applied voltage will be the reference for the currents and voltages within the circuit, we may define it as having a zero phase angle: $E = 100 \angle 0^\circ$. Then:

$$\begin{aligned} I &= \frac{100 \angle 0^\circ}{282 \angle -45^\circ} = 0.354 \angle 0^\circ - (-45^\circ) \\ &= 0.354 \angle 45^\circ \text{ amperes.} \end{aligned}$$

This same current must flow through all three elements of the circuit, since they are in series and the current through one must already have passed through the other two. Hence the voltage drop across the resistor (whose phase angle of course is 0°) is:

$$\begin{aligned} E &= I R \\ E &= (0.354 \angle 45^\circ) (200 \angle 0^\circ) \\ &= 70.8 \angle 45^\circ \text{ volts} \end{aligned}$$

The voltage drop across the inductive reactance is:

$$\begin{aligned} E &= I X_L \\ E &= (0.354 \angle 45^\circ) (100 \angle 90^\circ) \\ &= 35.4 \angle 135^\circ \text{ volts} \end{aligned}$$

Similarly, the voltage drop across the capacitive reactance is:

$$\begin{aligned} E &= I X_C \\ E &= (0.354 \angle 45^\circ) (300 \angle -90^\circ) \\ &= 106.2 \angle -45^\circ \end{aligned}$$

Note that the voltage drop across the capacitive reactance is greater than the supply voltage. This condition often occurs in a series RLC circuit, and is explained by the fact that the drop across the capacitive reactance is cancelled to a lesser or greater extent by the drop across the inductive reactance.

It is often desirable in a problem such as the above to check the validity of the answer by adding vectorially the voltage drops across the components of the series circuit to make sure that they add up to the supply voltage — or to use the terminology of Kirchhoff's Second Law, to make sure that the voltage drops across all elements of the circuit, including the source taken as negative, is equal to zero.

In the general case of the addition of a number of voltage vectors in series it is best to resolve the voltages into their in-phase and out-of-phase components with respect to the supply voltage. Then these components may be added directly. Hence:

$$\begin{aligned} E_R &= 70.8 \angle 45^\circ \\ &= 70.8 (\cos 45^\circ + j \sin 45^\circ) \\ &= 70.8 (0.707 + j0.707) \\ &= 50 + j50 \end{aligned}$$

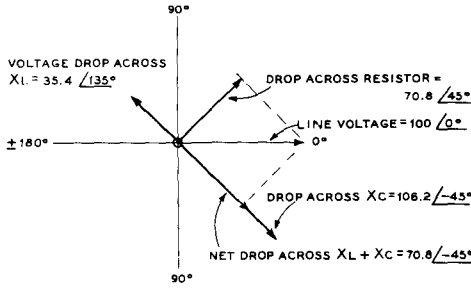

Figure 14

Graphical construction of the voltage drops associated with the series R-L-C circuit of figure 13.

$$\begin{aligned}
 E_L &= 35.4 \angle 135^\circ \\
 &= 35.4 (\cos 135^\circ + j \sin 135^\circ) \\
 &= 35.4 (-0.707 + j0.707) \\
 &= -25 + j25
 \end{aligned}$$

$$\begin{aligned}
 E_C &= 106.2 \angle 45^\circ \\
 &= 106.2 (\cos -45^\circ + j \sin -45^\circ) \\
 &= 106.2 (0.707 - j0.707) \\
 &= 75 - j75
 \end{aligned}$$

$$\begin{aligned}
 E_R + E_L + E_C &= (50 + j50) + (-25 + j25) \\
 &\quad + (75 - j75) \\
 &= (50 - 25 + 75) + j(50 + 25 - 75) \\
 &= 100 + j0 \\
 &= 100 \angle 0^\circ, \text{ which is equal to the} \\
 &\text{supply voltage.}
 \end{aligned}$$

Checking by Construction on the Complex Plane

It is frequently desirable to check computations involving complex quantities by constructing vectors representing the quantities on the complex plane. Figure 14 shows such a construction for the quantities of the problem just completed. Note that the answer to the problem may be checked by constructing a parallelogram with the voltage drop across the resistor as one side and the net voltage drop across the capacitor plus the inductor (these may be added algebraically as they are 180° out of phase) as the adjacent side. The vector sum of these two voltages, which is represented by the diagonal of the parallelogram, is equal to the supply voltage of 100 volts at zero phase angle.

Resistance and Reactance in Parallel

In a series circuit, such as just discussed, the current through all the ele-

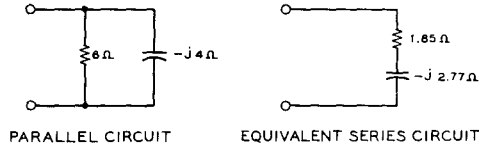

Figure 15

THE EQUIVALENT SERIES CIRCUIT

Showing a parallel R-C circuit and the equivalent series R-C circuit which represents the same net impedance as the parallel circuit.

ments which go to make up the series circuit is the same. But the voltage drops across each of the components are, in general, different from one another. Conversely, in a parallel RLC or RX circuit the voltage is, obviously, the same across each of the elements. But the currents through each of the elements are usually different.

There are many ways of solving a problem involving paralleled resistance and reactance; several of these ways will be described. In general, it may be said that the impedance of a number of elements in parallel is solved using the same relations as are used for solving resistors in parallel, except that complex quantities are employed. The basic relation is:

$$\frac{1}{Z_{tot}} = \frac{1}{Z_1} + \frac{1}{Z_2} + \frac{1}{Z_3} + \dots$$

or when only two impedances are involved:

$$Z_{tot} = \frac{Z_1 Z_2}{Z_1 + Z_2}$$

As an example, using the two-impedance relation, take the simple case, illustrated in figure 15, of a resistance of 6 ohms in parallel with a capacitive reactance of 4 ohms. To simplify the first step in the computation it is best to put the impedances in the polar form for the numerator, since multiplication is involved, and in the rectangular form for the addition in the denominator.

$$\begin{aligned}
 Z_{tot} &= \frac{(6 \angle 0^\circ) (4 \angle -90^\circ)}{6 - j4} \\
 &= \frac{24 \angle -90^\circ}{6 - j4}
 \end{aligned}$$

Then the denominator is changed to the polar form for the division operation:

$$\theta = \tan^{-1} \frac{-4}{6} = \tan^{-1} -0.667 = -33.7^\circ$$

$$|Z| = \frac{6}{\cos - 33.7^\circ} = \frac{6}{0.832} = 7.21 \text{ ohms}$$

$$6 - j4 = 7.21 \angle -33.7^\circ$$

Then:

$$Z_{\text{tot}} = \frac{24 \angle -90^\circ}{7.21 \angle -33.7^\circ} = 3.33 \angle -56.3^\circ$$

$$= 3.33 (\cos -56.3^\circ + j \sin -56.3^\circ)$$

$$= 3.33 [0.5548 + j (-0.832)]$$

$$= 1.85 - j 2.77$$

Equivalent Series Circuit Through the series of operations in the previous paragraph we have converted a circuit composed of two impedances in parallel into an *equivalent series circuit* composed of impedances in series. An equivalent series circuit is one which, as far as the terminals are concerned, acts identically to the original parallel circuit; the current through the circuit and the power dissipation of the resistive elements are the same for a given voltage at the specified frequency.

We can check the equivalent series circuit of figure 15 with respect to the original circuit by assuming that one volt a.c. (at the frequency where the capacitive reactance in the parallel circuit is 4 ohms) is applied to the terminals of both.

In the parallel circuit the current through the resistor will be $\frac{1}{4}$ ampere (0.166a.) while the current through the capacitor will be $j \frac{1}{4}$ ampere (+ j 0.25 a.). The total current will be the sum of these two currents, or $0.166 + j 0.25$ a. Adding these vectorially we obtain:

$$|I| = \sqrt{0.166^2 + 0.25^2} = \sqrt{0.09} = 0.3 \text{ a.}$$

The dissipation in the resistor will be $I^2/6 = 0.166$ watts.

In the case of the equivalent series circuit the current will be:

$$|I| = \frac{E}{|Z|} = \frac{1}{3.33} = 0.3 \text{ a.}$$

And the dissipation in the resistor will be:

$$W = I^2R = 0.3^2 \times 1.85$$

$$= 0.9 \times 1.85$$

$$= 0.166 \text{ watts}$$

So we see that the equivalent series circuit checks exactly with the original parallel circuit.

Parallel RLC Circuits In solving a more complicated circuit made up of more than two impedances in parallel we

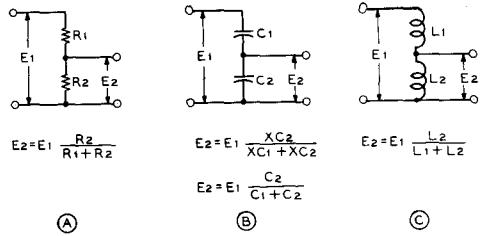

Figure 16
SIMPLE A-C VOLTAGE DIVIDERS

may elect to use either of two methods of solution. These methods are called the *admittance* method and the *assumed-voltage* method. However, the two methods are equivalent since both use the sum-of-reciprocals equation:

$$\frac{1}{Z_{\text{tot}}} = \frac{1}{Z_1} + \frac{1}{Z_2} + \frac{1}{Z_3} \dots$$

In the admittance method we use the relation $Y = 1/Z$, where $Y = G + jB$; Y is called the *admittance*, defined above, G is the *conductance* or R/Z^2 and B is the *susceptance* or $-X/Z^2$. Then $Y_{\text{tot}} = 1/Z_{\text{tot}} = Y_1 + Y_2 + Y_3 \dots$ In the assumed-voltage method we multiply both sides of the equation above by E , the assumed voltage, and add the currents, as:

$$\frac{E}{Z_{\text{tot}}} = \frac{E}{Z_1} + \frac{E}{Z_2} + \frac{E}{Z_3} \dots = I_{Z_1} + I_{Z_2} + I_{Z_3} \dots$$

Then the impedance of the parallel combination may be determined from the relation:

$$Z_{\text{tot}} = E/I_{Z_{\text{tot}}}$$

AC Voltage Dividers Voltage dividers for use with alternating current are quite similar to d-c voltage dividers. However, since capacitors and inductors oppose the flow of a-c current as well as resistors, voltage dividers for alternating voltages may take any of the configurations shown in figure 16.

Since the impedances within each divider are of the same type, the output voltage is in phase with the input voltage. By using combinations of different types of impedances, the phase angle of the output may be shifted in relation to the input phase angle at the same time the amplitude is reduced. Several dividers of this type are shown in figure 17. Note that the ratio of output voltage to input voltage is equal to the ratio of the output impedance to the total divider impedance. This relationship is true only if negligible current is drawn by a load on the output terminals.

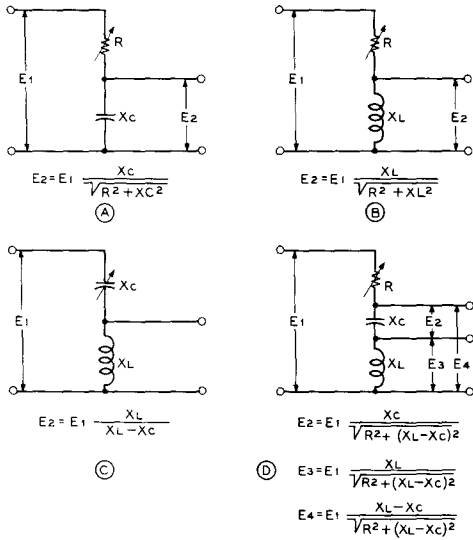

Figure 17
COMPLEX A-C VOLTAGE DIVIDERS



Figure 18
SERIES RESONANT CIRCUIT

If the values of inductance and capacitance both are fixed, there will be only one resonant frequency.

If both the inductance and capacitance are made variable, the circuit may then be changed or *tuned*, so that a number of combinations of inductance and capacitance can resonate at the same frequency. This can be more easily understood when one considers that inductive reactance and capacitive reactance travel in opposite directions as the frequency is changed. For example, if the frequency were to remain constant and the values of inductance and capacitance were then changed, the following combinations would have equal *reactance*:

Frequency is constant at 60 cycles.

L is expressed in henrys.

C is expressed in microfarads (.000001 farad.)

L	X_L	C	X_C
.265	100	26.5	100
2.65	1,000	2.65	1,000
26.5	10,000	.265	10,000
265.00	100,000	.0265	100,000
2,650.00	1,000,000	.00265	1,000,000

Frequency of Resonance From the formula for resonance, $2\pi fL = 1/2\pi fC$, the resonant frequency is determined:

$$f = \frac{1}{2\pi\sqrt{LC}}$$

where f = frequency in cycles,
L = inductance in henrys,
C = capacitance in farads.

It is more convenient to express L and C in smaller units, especially in making radio-frequency calculations; f can also be expressed in megacycles or kilocycles. A very useful group of such formulas is:

$$f^2 = \frac{25,330}{LC} \text{ or } L = \frac{25,330}{f^2 C} \text{ or } C = \frac{25,330}{f^2 L}$$

where f = frequency in megacycles,
L = inductance in microhenrys,
C = capacitance in micromicrofarads.

3-2 Resonant Circuits

A series circuit such as shown in figure 18 is said to be in *resonance* when the applied frequency is such that the capacitive reactance is exactly balanced by the inductive reactance. At this frequency the two reactances will cancel in their effects, and the impedance of the circuit will be at a minimum so that maximum current will flow. In fact, as shown in figure 19 the net impedance of a series circuit at resonance is equal to the resistance which remains in the circuit after the reactances have been cancelled.

Resonant Frequency Some resistance is always present in a circuit because it is possessed in some degree by both the inductor and the capacitor. If the frequency of the alternator E is varied from nearly zero to some high frequency, there will be one particular frequency at which the inductive reactance and capacitive reactance will be equal. This is known as the *resonant frequency*, and in a series circuit it is the frequency at which the circuit current will be a maximum. Such series resonant circuits are chiefly used when it is desirable to allow a certain frequency to pass through the circuit (low impedance to this frequency), while at the same time the circuit is made to offer considerable opposition to currents of other frequencies.

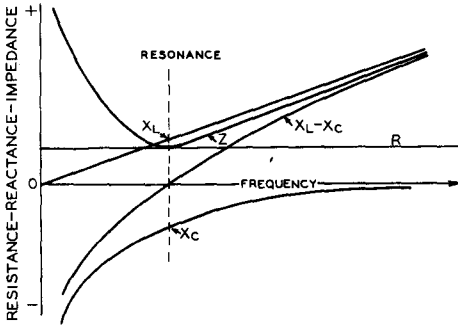

Figure 19
IMPEDANCE OF A
SERIES-RESONANT CIRCUIT

Showing the variation in reactance of the separate elements and in the net impedance of a series resonant circuit (such as figure 18) with changing frequency. The vertical line is drawn at the point of resonance ($X_L - X_C = 0$) in the series circuit.

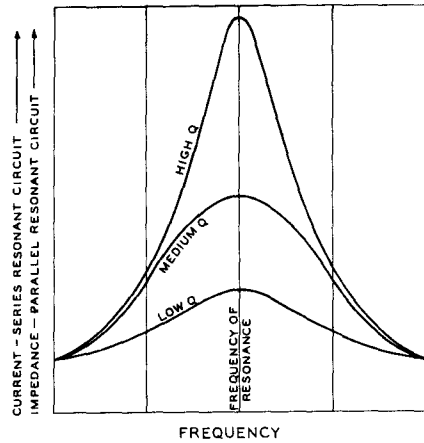

Figure 20
RESONANCE CURVE

Showing the increase in impedance at resonance for a parallel-resonant circuit, and similarly, the increase in current at resonance for a series-resonant circuit. The sharpness of resonance is determined by a comparison between A, B, and C.

Impedance of Series Resonant Circuits The impedance across the terminals of a series resonant circuit (figure 18) is:

$$Z = \sqrt{r^2 + (X_L - X_C)^2}$$

- where Z = impedance in ohms,
- r = resistance in ohms,
- X_C = capacitive reactance in ohms,
- X_L = inductive reactance in ohms.

From this equation, it can be seen that the impedance is equal to the vector sum of the circuit resistance and the difference between the two reactances. Since at the resonant frequency X_L equals X_C , the difference between them (figure 19) is zero, so that at resonance the impedance is simply equal to the resistance of the circuit; therefore, because the resistance of most normal radio-frequency circuits is of a very low order, the impedance is also low.

At frequencies higher and lower than the resonant frequency, the difference between the reactances will be a definite quantity and will add with the resistance to make the impedance higher and higher as the circuit is tuned off the resonant frequency.

If X_C should be greater than X_L , then the term $(X_L - X_C)$ will give a negative number. However, when the difference is squared the product is always positive. This means that the smaller reactance is subtracted from the larger, regardless of whether it be capacitive or inductive, and the difference squared.

Current and Voltage in Series Resonant Circuits Formulas for calculating currents and voltages in a series resonant circuit are similar to those of

Ohm's law.

$$I = \frac{E}{Z} \quad E = IZ$$

The complete equations:

$$I = \frac{E}{\sqrt{r^2 + (X_L - X_C)^2}}$$

$$E = I \sqrt{r^2 + (X_L - X_C)^2}$$

Inspection of the above formulas will show the following to apply to series resonant circuits: When the impedance is low, the current will be high; conversely, when the impedance is high, the current will be low.

Since it is known that the impedance will be very low at the resonant frequency, it follows that the current will be a maximum at this point. If a graph is plotted of the current against the frequency either side of resonance, the resultant curve becomes what is known as a resonance curve. Such a curve is shown in figure 20, the frequency being plotted against current in the series resonant circuit.

Several factors will have an effect on the shape of this resonance curve, of which re-

sistance and L-to-C ratio are the important considerations. The curves B and C in figure 20 show the effect of adding increasing values of resistance to the circuit. It will be seen that the peaks become less and less prominent as the resistance is increased; thus, it can be said that the *selectivity* of the circuit is thereby *decreased*. Selectivity in this case can be defined as the ability of a circuit to discriminate against frequencies adjacent to the resonant frequency.

Voltage Across Coil and Capacitor in Series Circuit Because the a.c. or r-f voltage across a coil and capacitor is proportional to the reactance (for a given current), the actual voltages across the coil and across the capacitor may be many times greater than the *terminal* voltage of the circuit. At resonance, the voltage across the coil (or the capacitor) is Q times the applied voltage. Since the Q (or merit factor) of a series circuit can be in the neighborhood of 100 or more, the voltage across the capacitor, for example, may be high enough to cause flashover, even though the applied voltage is of a value considerably below that at which the capacitor is rated.

Circuit Q — Sharpness of Resonance An extremely important property of a capacitor or an inductor is its factor-of-merit, more generally called its Q. It is this factor, Q, which primarily determines the sharpness of resonance of a tuned circuit. This factor can be expressed as the ratio of the reactance to the resistance, as follows:

$$Q = \frac{2\pi fL}{R},$$

where R = total resistance.

Skin Effect The actual resistance in a wire or an inductor can be far greater than the d-c value when the coil is used in a radio-frequency circuit; this is because the current does not travel through the entire cross-section of the conductor, but has a tendency to travel closer and closer to the surface of the wire as the frequency is increased. This is known as the *skin effect*.

The actual current-carrying portion of the wire is decreased, as a result of the skin effect, so that the ratio of a-c to d-c resistance of the wire, called the *resistance ratio*, is increased. The resistance ratio of wires to be used at frequencies below about 500 kc. may be materially reduced through the use of *litz* wire. Litz wire, of the type commonly used to wind the coils of 455-kc. i-f transformers, may consist of 3 to 10 strands of insulated wire, about No. 40 in size, with the individual

strands connected together only at the ends of the coils.

Variation of Q with Frequency Examination of the equation for determining Q might give rise to the thought that even though the resistance of an inductor increases with frequency, the inductive reactance does likewise, so that the Q might be a constant. Actually, however, it works out in practice that the Q of an inductor will reach a relatively broad maximum at some particular frequency. Hence, coils normally are designed in such a manner that the peak in their curve of Q with frequency will occur at the normal operating frequency of the coil in the circuit for which it is designed.

The Q of a capacitor ordinarily is much higher than that of the best coil. Therefore, it usually is the merit of the coil that limits the overall Q of the circuit.

At audio frequencies the core losses in an iron-core inductor greatly reduce the Q from the value that would be obtained simply by dividing the reactance by the resistance. Obviously the core losses also represent circuit resistance, just as though the loss occurred in the wire itself.

Parallel Resonance In radio circuits, parallel resonance (more correctly termed *anti-resonance*) is more frequently encountered than series resonance; in fact, it is the basic foundation of receiver and transmitter circuit operation. A circuit is shown in figure 21.

The "Tank" Circuit In this circuit, as contrasted with a circuit for series resonance, L (inductance) and C (capacitance) are connected in *parallel*, yet the *combination* can be considered to be in series with the remainder of the circuit. This combination of L and C, in conjunction with R, the resistance which is principally included in L, is sometimes called a *tank* circuit because it effectively functions as a storage tank when incorporated in vacuum tube circuits.

Contrasted with series resonance, there are two kinds of current which must be considered in a parallel resonant circuit: (1) the line current, as read on the indicating meter M_1 , (2) the circulating current which flows within the parallel L-C-R portion of the circuit. See figure 21.

At the resonant frequency, the line current (as read on the meter M_1) will drop to a very low value although the circulating current in the L-C circuit may be quite large. It is interesting to note that the parallel resonant circuit acts in a distinctly opposite manner to that of a series resonant circuit, in which the

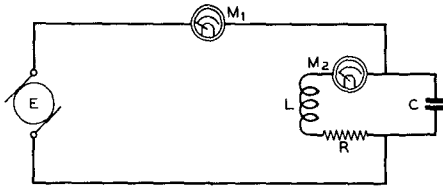

Figure 21

PARALLEL-RESONANT CIRCUIT

The inductance L and capacitance C comprise the reactive elements of the parallel-resonant (anti-resonant) tank circuit, and the resistance R indicates the sum of the r-f resistance of the coil and capacitor, plus the resistance coupled into the circuit from the external load. In most cases the tuning capacitor has much lower r-f resistance than the coil and can therefore be ignored in comparison with the coil resistance and the coupled-in resistance. The instrument M_1 indicates the "line current" which keeps the circuit in a state of oscillation—this current is the same as the fundamental component of the plate current of a Class C amplifier which might be feeding the tank circuit. The instrument M_2 indicates the "tank current" which is equal to the line current multiplied by the operating Q of the tank circuit.

current is at a maximum and the impedance is minimum at resonance. It is for this reason that in a parallel resonant circuit the principal consideration is one of impedance rather than current. It is also significant that the *impedance* curve for *parallel* circuits is very nearly identical to that of the *current* curve for *series* resonance. The impedance at resonance is expressed as:

$$Z = \frac{(2\pi fL)^2}{R},$$

where Z = impedance in ohms,
 L = inductance in henrys,
 f = frequency in cycles,
 R = resistance in ohms.

Or, impedance can be expressed as a function of Q as:

$$Z = 2\pi fLQ,$$

showing that the impedance of a circuit is directly proportional to its effective Q at resonance.

The curves illustrated in figure 20 can be applied to parallel resonance. Reference to the curve will show that the effect of adding resistance to the circuit will result in both a broadening out and lowering of the peak of the curve. Since the voltage of the circuit is directly proportional to the impedance, and since it is this voltage that is applied to the grid of the vacuum tube in a detector or am-

plifier circuit, the impedance curve must have a sharp peak in order for the circuit to be *selective*. If the curve is broad-topped in shape, both the desired signal and the interfering signals at close proximity to resonance will give nearly equal voltages on the grid of the tube, and the circuit will then be *non-selective*; i.e., it will tune broadly.

Effect of L/C Ratio in Parallel Circuits In order that the highest possible voltage can be developed across a parallel resonant circuit, the impedance of this circuit must be very high. The impedance will be greater with conventional coils of limited Q when the ratio of inductance-to-capacitance is great, that is, when L is large as compared with C . When the resistance of the circuit is very low, X_L will equal X_C at maximum impedance. There are innumerable ratios of L and C that will have *equal* reactance, at a given resonant frequency, exactly as in the case in a series resonant circuit.

In practice, where a certain value of inductance is tuned by a variable capacitance over a fairly wide range in frequency, the L/C ratio will be small at the lowest frequency end and large at the high-frequency end. The circuit, therefore, will have unequal gain and selectivity at the two ends of the band of frequencies which is being tuned. Increasing the Q of the circuit (lowering the resistance) will obviously increase *both* the selectivity and gain.

Circulating Tank Current at Resonance The Q of a circuit has a definite bearing on the circulating tank current at resonance. This tank current is very nearly the value of the line current multiplied by the effective circuit Q . For example: an r-f line current of 0.050 amperes, with a circuit Q of 100, will give a circulating tank current of approximately 5 amperes. From this it can be seen that both the inductor and the connecting wires in a circuit with a high Q must be of very low resistance, particularly in the case of high power transmitters, if heat losses are to be held to a minimum.

Because the voltage across the tank at resonance is determined by the Q , it is possible to develop very high peak voltages across a high Q tank with but little line current.

Effect of Coupling on Impedance If a parallel resonant circuit is coupled to another circuit, such as an antenna output circuit, the impedance and the effective Q of the parallel circuit is decreased as the coupling becomes closer. The effect of closer (tighter) coupling is the same as though an

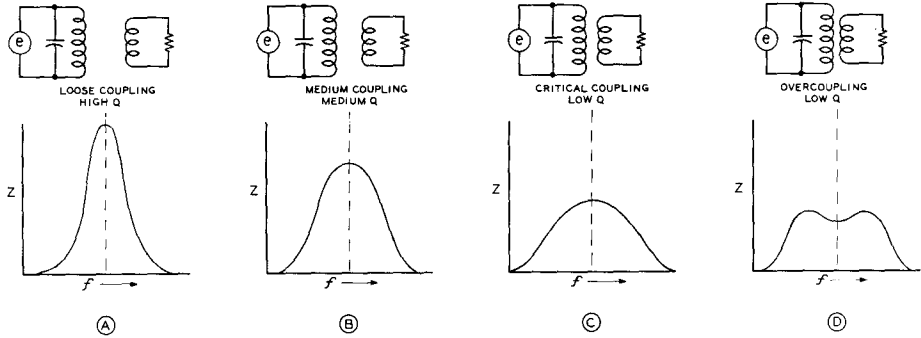

Figure 22
EFFECT OF COUPLING ON CIRCUIT IMPEDANCE AND Q

actual resistance were added in series with the parallel tank circuit. The resistance thus coupled into the tank circuit can be considered as being *reflected* from the output or load circuit to the driver circuit.

The behavior of coupled circuits depends largely upon the amount of coupling, as shown in figure 22. The coupled current in the secondary circuit is small, varying with frequency, being maximum at the resonant frequency of the circuit. As the coupling is increased between the two circuits, the secondary resonance curve becomes broader and the resonant amplitude increases, until the reflected resistance is equal to the primary resistance. This point is called the *critical coupling point*. With greater coupling, the secondary resonance curve becomes broader and develops double resonance humps, which become more pronounced and farther apart in frequency as the coupling between the two circuits is increased.

Tank Circuit Flywheel Effect When the plate circuit of a Class B or Class C operated tube is connected to a parallel resonant circuit tuned to the same frequency as the exciting voltage for the amplifier, the plate current serves to maintain this L/C circuit in a state of oscillation.

The plate current is supplied in short pulses which do not begin to resemble a sine wave, even though the grid may be excited by a sine-wave voltage. These spurts of plate current are converted into a sine wave in the plate tank circuit by virtue of the "Q" or "flywheel effect" of the tank.

If a tank did not have some resistance losses, it would, when given a "kick" with a single pulse, continue to oscillate indefinitely. With a moderate amount of resistance or "friction" in the circuit the tank will still have

inertia, and continue to oscillate with decreasing amplitude for a time after being given a "kick." With such a circuit, almost pure sine-wave voltage will be developed across the tank circuit even though power is supplied to the tank in short pulses or spurts, so long as the spurts are evenly spaced with respect to time and have a frequency that is the same as the resonant frequency of the tank.

Another way to visualize the action of the tank is to recall that a resonant tank with moderate Q will discriminate strongly against harmonics of the resonant frequency. The distorted plate current pulse in a Class C amplifier contains not only the fundamental frequency (that of the grid excitation voltage) but also higher harmonics. As the tank offers low impedance to the harmonics and high impedance to the fundamental (being resonant to the latter), only the fundamental — a sine-wave voltage — appears across the tank circuit in substantial magnitude.

Loaded and Unloaded Q Confusion sometimes exists as to the relationship between the unloaded and the loaded Q of the tank circuit in the plate of an r-f power amplifier. In the normal case the loaded Q of the tank circuit is determined by such factors as the operating conditions of the amplifier, bandwidth of the signal to be emitted, permissible level of harmonic radiation, and such factors. The normal value of *loaded* Q for an r-f amplifier used for communications service is from perhaps 6 to 20. The *unloaded* Q of the tank circuit determines the efficiency of the output circuit and is determined by the losses in the tank coil, its leads and plugs and jacks if any, and by the losses in the tank capacitor which ordinarily are very low. The unloaded Q of a good quality large diameter tank coil in the high-frequency range may be as high as 500

to 800, and values greater than 300 are quite common.

Tank Circuit Efficiency Since the unloaded Q of a tank circuit is determined by the minimum losses in the tank, while the loaded Q is determined by useful loading of the tank circuit from the external load in addition to the internal losses in the tank circuit, the relationship between the two Q values determines the operating efficiency of the tank circuit. Expressed in the form of an equation, the loaded efficiency of a tank circuit is:

$$\text{Tank efficiency} = 1 - \frac{Q_l}{Q_u} \times 100$$

where Q_u = unloaded Q of the tank circuit
 Q_l = loaded Q of the tank circuit

As an example, if the unloaded Q of the tank circuit for a class C r-f power amplifier is 400, and the external load is coupled to the tank circuit by an amount such that the loaded Q is 20, the tank circuit efficiency will be: $\text{eff.} = (1 - 20/400) \times 100$, or $(1 - 0.05) \times 100$, or 95 per cent. Hence 5 per cent of the power output of the Class C amplifier will be lost as heat in the tank circuit and the remaining 95 per cent will be delivered to the load.

3-3 Nonsinusoidal Waves and Transients

Pure sine waves, discussed previously, are basic wave shapes. Waves of many different and complex shape are used in electronics, particularly square waves, saw-tooth waves, and peaked waves.

Wave Composition Any periodic wave (one that repeats itself in definite time intervals) is composed of sine waves of different frequencies and amplitudes, added together. The sine wave which has the same frequency as the complex, periodic wave is called the *fundamental*. The frequencies higher than the fundamental are called *harmonics*, and are always a whole number of times higher than the fundamental. For example, the frequency twice as high as the fundamental is called the second harmonic.

The Square Wave Figure 23 compares a square wave with a sine wave (A) of the same frequency. If another sine wave (B) of smaller amplitude, but three times the frequency of (A), called the third harmonic, is added to (A), the resultant wave (C) more nearly approaches the desired square wave.

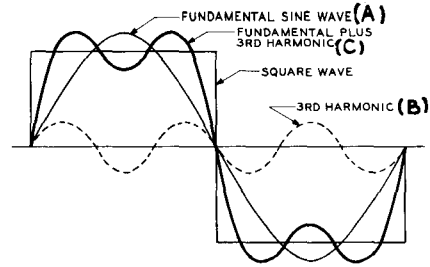

Figure 23
COMPOSITE WAVE-FUNDAMENTAL PLUS THIRD HARMONIC

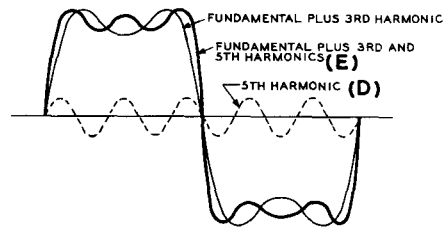

Figure 24
THIRD HARMONIC WAVE PLUS FIFTH HARMONIC

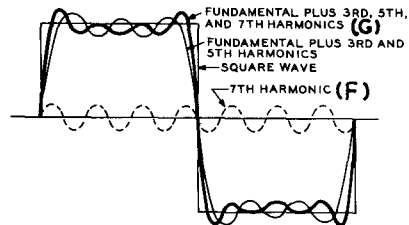

Figure 25
RESULTANT WAVE, COMPOSED OF FUNDAMENTAL, THIRD, FIFTH, AND SEVENTH HARMONICS

This resultant curve (figure 24) is added to a fifth harmonic curve (D), and the sides of the resulting curve (E) are steeper than before. This new curve is shown in figure 25 after a 7th harmonic component has been added to it, making the sides of the composite wave even steeper. Addition of more higher odd harmonics will bring the resultant wave nearer and nearer to the desired square wave shape. The square wave will be achieved if an infinite number of odd harmonics are added to the original sine wave.

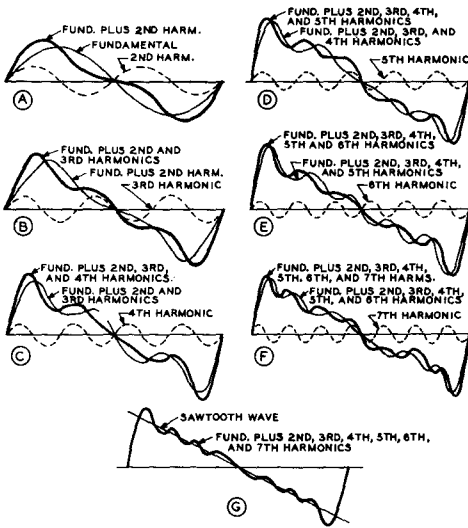

Figure 26
COMPOSITION OF A SAWTOOTH WAVE

The Sawtooth Wave In the same fashion, a sawtooth wave is made up of different sine waves (figure 26). The addition of all harmonics, odd and even, produces the sawtooth wave form.

The Peaked Wave Figure 27 shows the composition of a peaked wave. Note how the addition of each successive harmonic makes the peak of the resultant higher and the sides steeper.

Other Waveforms The three preceding examples show how a complex periodic wave is composed of a fundamental wave and different harmonics. The shape of the resultant wave depends upon the harmonics that are added, their relative amplitudes, and relative phase relationships. In general, the steeper the sides of the waveform, the more harmonics it contains.

AC Transient Circuits If an a-c voltage is substituted for the d-c input voltage in the RC Transient circuits discussed in Chapter 2, the same principles may be applied in the analysis of the transient behavior. An RC coupling circuit is designed to have a long time constant with respect to the lowest frequency it must pass. Such a circuit is shown in figure 28. If a nonsinusoidal voltage is to be passed unchanged through the coupling circuit, the time constant

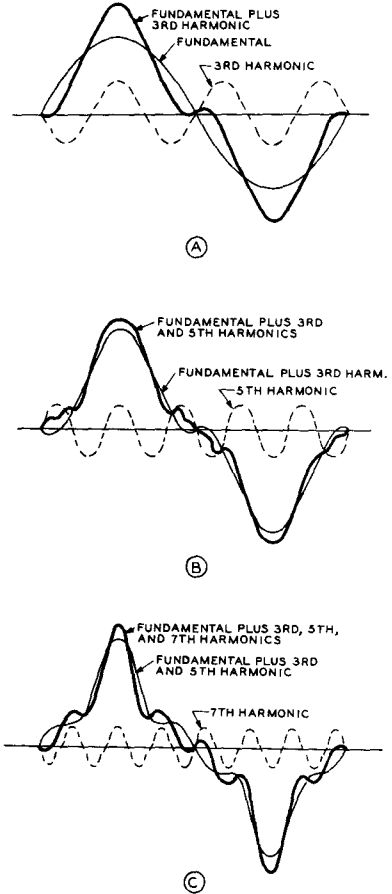

Figure 27
COMPOSITION OF A PEAKED WAVE

must be long with respect to the period of the lowest frequency contained in the voltage wave.

RC Differentiator and Integrator An RC voltage divider that is designed to distort the input waveform is known as a *differentiator* or *integrator*, depending upon the locations of the output taps. The output from a differentiator is taken across the resistance, while the output from an integrator is taken across the capacitor. Such circuits will change the shape of any complex a-c waveform that is impressed upon them. This distortion is a function of the value of the time constant of the circuit as compared to the period of the waveform. Neither a differentiator nor an integrator can change the

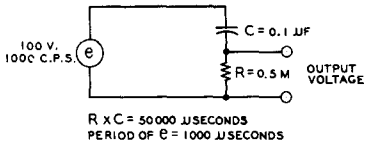

Figure 28
R-C COUPLING CIRCUIT WITH LONG TIME CONSTANT

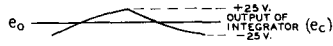
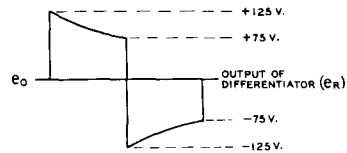
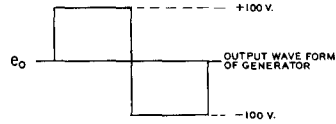
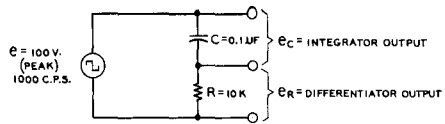

Figure 30
R-C DIFFERENTIATOR AND INTEGRATOR ACTION ON A SQUARE WAVE

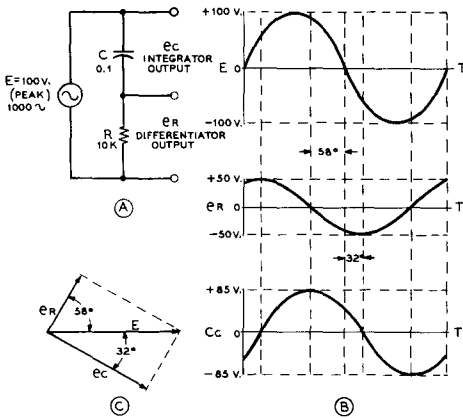

Figure 29
R-C DIFFERENTIATOR AND INTEGRATOR ACTION ON A SINE WAVE

shape of a pure sine wave, they will merely shift the phase of the wave (figure 29). The differentiator output is a sine wave leading the input wave, and the integrator output is a sine wave which lags the input wave. The sum of the two outputs at any instant equals the instantaneous input voltage.

Square Wave Input If a square wave voltage is impressed on the circuit of figure 30, a square wave voltage output may be obtained across the integrating capacitor if the time constant of the circuit allows the capacitor to become fully charged. In this particular case, the capacitor never fully charges, and as a result the output of the integrator has a smaller amplitude than the input. The differentiator output has a maximum value greater than the input amplitude, since the voltage left on the capacitor from the previous half wave will add to the input voltage. Such a circuit, when used as a differentiator, is often called a *peaker*. Peaks of twice the input amplitude may be produced.

Sawtooth Wave Input If a back-to-back sawtooth voltage is applied to an RC circuit having a time constant one-sixth the period of the input voltage, the result is shown in figure 31. The capacitor voltage will closely follow the input voltage, if the time constant is short, and the integrator output closely resembles the input. The amplitude is slightly reduced and there is a slight phase lag. Since the voltage across the capacitor is increasing at a constant rate, the charging and discharging current is constant. The output voltage of the differentiator, therefore, is constant during each half of the sawtooth input.

Miscellaneous Inputs Various voltage waveforms other than those represented here may be applied to short RC circuits for the purpose of producing across the resistor an output voltage with an amplitude *proportional to the rate of change* of the input signal. The shorter the RC time constant is made with respect to the period of the input wave, the more nearly the voltage across

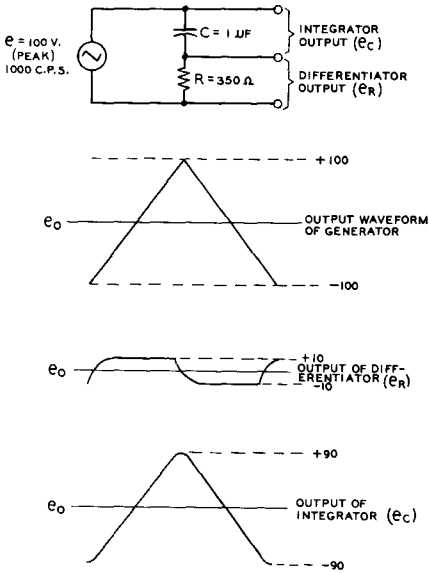

Figure 31
R-C DIFFERENTIATOR AND
INTEGRATOR ACTION ON
A SAWTOOTH WAVE

the capacitor conforms to the input voltage. Thus, the differentiator output becomes of particular importance in very short RC circuits. Differentiator outputs for various types of input waves are shown in figure 32.

Square Wave Test The application of a square wave input signal to audio equipment, and the observation of the reproduced output signal on an oscilloscope will provide a quick and accurate check of the overall operation of audio equipment. Low-frequency and high-frequency response, as well as transient response can be examined easily. If the amplifier is deficient in low-frequency response, the flat top of the square wave will be canted, as in figure 33. If the high-frequency response is inferior, the rise time of the output wave will be retarded (figure 34). An amplifier with a limited high- and low-frequency response will turn the square wave into the approximation of a sawtooth wave (figure 35).

3.4 Transformers

When two coils are placed in such inductive relation to each other that the lines of force from one cut across the turns of the other inducing a current, the combination can be called a *transformer*. The name is derived from the fact that energy is transformed from one winding to another. The inductance in which

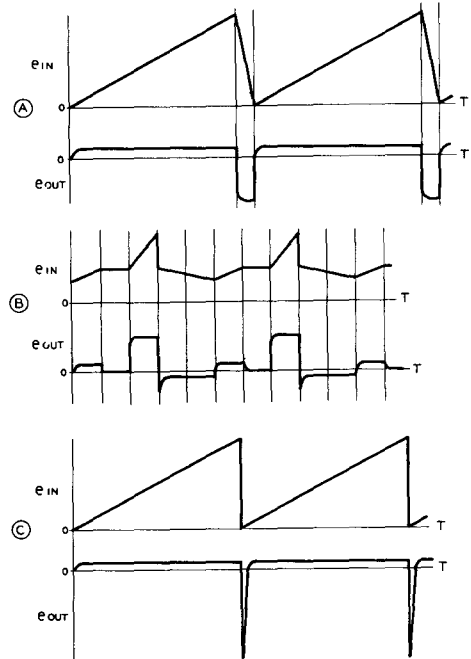

Figure 32

Differentiator outputs of short r-c circuits for various input voltage waveshapes. The output voltage is proportional to the rate of change of the input voltage.

the original flux is produced is called the *primary*; the inductance which receives the induced current is called the *secondary*. In a radio receiver power transformer, for example, the coil through which the 110-volt a.c. passes is the primary, and the coil from which a higher or lower voltage than the a-c line potential is obtained is the *secondary*.

Transformers can have either air or magnetic cores, depending upon the frequencies at which they are to be operated. The reader should thoroughly impress upon his mind the fact that current can be transferred from one circuit to another *only* if the primary current is changing or alternating. From this it can be seen that a power transformer cannot possibly function as such when the primary is supplied with non-pulsating d.c.

A power transformer usually has a magnetic core which consists of laminations of iron, built up into a square or rectangular form, with a center opening or window. The secondary windings may be several in number, each perhaps delivering a different voltage. The secondary voltages will be proportional to the turns ratio and the primary voltage.

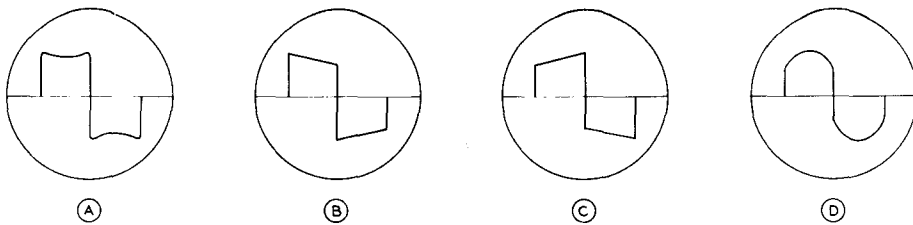

Figure 33

Amplifier deficient in low frequency response will distort square wave applied to the input circuit, as shown. A 60-cycle square wave may be used.

- A: Drop in gain at low frequencies
- B: Leading phase shift at low frequencies
- C: Lagging phase shift at low frequencies
- D: Accentuated low frequency gain

Types of Transformers are used in alternating-current circuits to transfer power at one voltage and impedance to another circuit at another voltage and impedance. There are three main classifications of transformers: those made for use in power-frequency circuits, those made for audio-frequency applications, and those made for radio frequencies.

The Transformation Ratio In a perfect transformer all the magnetic flux lines produced by the primary winding link every turn of the secondary winding. For such a transformer, the ratio of the primary and secondary voltages is exactly the same as the ratio of the number of turns in the two windings:

$$\frac{N_p}{N_s} = \frac{E_p}{E_s}$$

where N_p = number of turns in the primary winding

N_s = number of turns in the secondary winding

E_p = voltage across the primary winding

E_s = voltage across the secondary winding

In practice, the transformation ratio of a transformer is somewhat less than the turns ratio, since unity coupling does not exist between the primary and secondary windings.

Ampere Turns (NI) The current that flows in the secondary winding as a result of the induced voltage must produce a flux which exactly equals the primary flux. The magnetizing force of a coil is expressed as the product of the number of turns in the coil times the current flowing in it:

$$N_p \times I_p = N_s \times I_s, \text{ or } \frac{N_p}{N_s} = \frac{I_s}{I_p}$$

where I_p = primary current

I_s = secondary current

It can be seen from this expression that when the voltage is stepped up, the current is stepped down, and vice-versa.

Leakage Reactance Since unity coupling does not exist in a practical

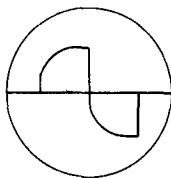

Figure 34

Output waveshape of amplifier having deficiency in high-frequency response. Tested with 10-kc. square wave.

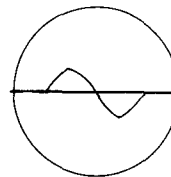

Figure 35

Output waveshape of amplifier having limited low-frequency and high-frequency response. Tested with 1-kc. square wave.

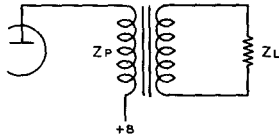

Figure 36
IMPEDANCE-MATCHING TRANSFORMER
The reflected impedance Z_p varies directly in proportion to the secondary load Z_L , and directly in proportion to the square of the primary-to-secondary turns ratio.

transformer, part of the flux passing from the primary circuit to the secondary circuit follows a magnetic circuit acted upon by the primary only. The same is true of the secondary flux. These leakage fluxes cause *leakage reactance* in the transformer, and tend to cause the transformer to have poor voltage regulation. To reduce such leakage reactance, the primary and secondary windings should be in close proximity to each other. The more expensive transformers have interleaved windings to reduce inherent leakage reactance.

Impedance Transformation In the ideal transformer, the impedance of the secondary load is reflected back into the primary winding in the following relationship:

$$Z_p = N^2 Z_s, \text{ or } N = \sqrt{Z_p / Z_s}$$

where Z_p = reflected primary impedance
 N = turns ratio of transformer
 Z_s = impedance of secondary load

Thus any specific load connected to the secondary terminals of the transformer will be transformed to a different specific value appearing across the primary terminals of the transformer. By the proper choice of turns ratio, any reasonable value of secondary load impedance may be "reflected" into the primary winding of the transformer to produce the desired transformer primary impedance. The phase angle of the primary "reflected" impedance will be the same as the phase angle of the load impedance. A capacitive secondary load will be presented to the transformer source as a capacity, a resistive load will present a resistive "reflection" to the primary source. Thus the primary source "sees" a transformer load entirely dependent upon the secondary load impedance and the turns ratio of the transformer (figure 36).

The Auto Transformer The type of transformer in figure 37, when wound with heavy wire over an iron core, is a common device in primary power circuits for the purpose of increasing or decreasing the line volt-

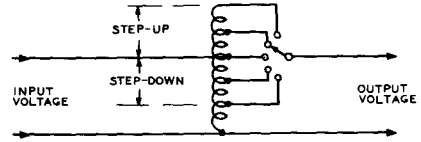

Figure 37
THE AUTO-TRANSFORMER
Schematic diagram of an auto-transformer showing the method of connecting it to the line and to the load. When only a small amount of step up or step down is required, the auto-transformer may be much smaller physically than would be a transformer with a separate secondary winding. Continuously variable auto-transformers (Variac and Powerstat) are widely used commercially.

age. In effect, it is merely a continuous winding with taps taken at various points along the winding, the input voltage being applied to the bottom and also to one tap on the winding. If the output is taken from this same tap, the voltage ratio will be 1-to-1; i.e., the input voltage will be the same as the output voltage. On the other hand, if the output tap is moved down toward the common terminal, there will be a step-down in the turns ratio with a consequent step-down in voltage. The initial setting of the middle input tap is chosen so that the number of turns will have sufficient reactance to keep the no-load primary current at a reasonably low value.

3-5 Electric Filters

There are many applications where it is desirable to pass a d-c component without passing a superimposed a-c component, or to

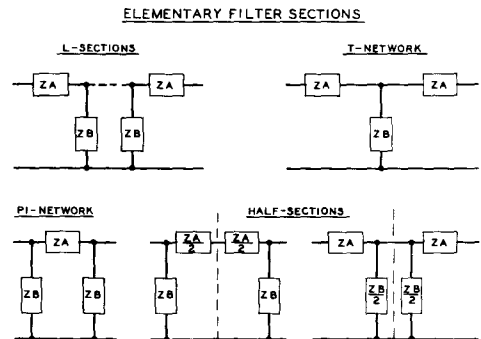
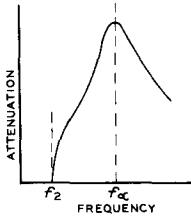
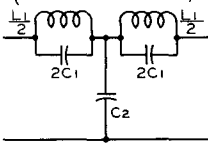

Figure 38
Complex filters may be made up from these basic filter sections.

LOW-PASS SHUNT-DERIVED FILTER
(SERIES-ARM RESONATED)



R = LOAD RESISTANCE
 $L_1 = M L K$
 $C_1 = \frac{1-M^2}{4M} \times C K$
 $C_2 = M C K$

$L K = \frac{R}{\pi f_2}$ $M = \sqrt{1 - \left(\frac{f_2}{f_c}\right)^2}$ $C K = \frac{1}{\pi f_2 R}$
 $f_2 = \text{CUT-OFF FREQUENCY. } f_c = \text{FREQUENCY OF HIGH ATTENUATION}$

HIGH-PASS SERIES-DERIVED FILTER
(SHUNT-ARM RESONATED)

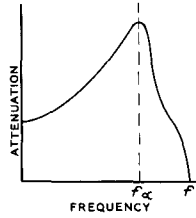
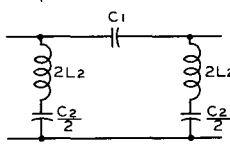

R = LOAD RESISTANCE
 $C_1 = \frac{C K}{M}$
 $C_2 = \frac{1-4M}{1-M^2} \times C K$
 $L_2 = \frac{L K}{M}$

$L K = \frac{R}{4\pi f_1}$ $M = \sqrt{1 - \left(\frac{f_c}{f_1}\right)^2}$ $C K = \frac{1}{4\pi f_1 R}$
 $f_1 = \text{CUT-OFF FREQUENCY. } f_c = \text{FREQUENCY OF HIGH ATTENUATION}$

Figure 39

TYPICAL LOW-PASS AND HIGH-PASS FILTERS, ILLUSTRATING SHUNT AND SERIES DERIVATIONS

pass all frequencies above or below a certain frequency while rejecting or attenuating all others, or to pass only a certain band or bands of frequencies while attenuating all others.

All of these things can be done by suitable combinations of inductance, capacitance and resistance. However, as whole books have been devoted to nothing but electric filters, it can be appreciated that it is possible only to touch upon them superficially in a general coverage book.

Filter Operation A filter acts by virtue of its property of offering very high impedance to the undesired frequencies, while offering but little impedance to the desired frequencies. This will also apply to d.c. with a superimposed a-c component, as d.c. can be considered as an alternating current of zero frequency so far as filter discussion goes.

Basic Filters Filters are divided into four classes, descriptive of the frequency bands which they are designed to transmit: high pass, low pass, band pass and band elimination. Each of these classes of filters is made up of elementary filter sections called *L sections* which consist of a series element (Z_A) and a parallel element (Z_B) as

illustrated in figure 38. A finite number of *L* sections may be combined into basic filter sections, called *T networks* or *pi networks*, also shown in figure 38. Both the *T* and *pi* networks may be divided in two to form *half-sections*.

Filter Sections The most common filter section is one in which the two impedances Z_A and Z_B are so related that their arithmetical product is a constant: $Z_A \times Z_B = K^2$ at all frequencies. This type of filter section is called a *constant-K section*.

A section having a sharper cutoff frequency than a constant-K section, but less attenuation at frequencies far removed from cutoff is the *M-derived section*, so called because the shunt or series element is resonated with a reactance of the opposite sign. If the complementary reactance is added to the series arm, the section is said to be *shunt derived*; if added to the shunt arm, *series derived*. Each impedance of the *M-derived section* is related to a corresponding impedance in the constant-K section by some factor which is a function of the constant *m*. *M*, in turn, is a function of the ratio between the cutoff frequency and the frequency of infinite attenuation, and will

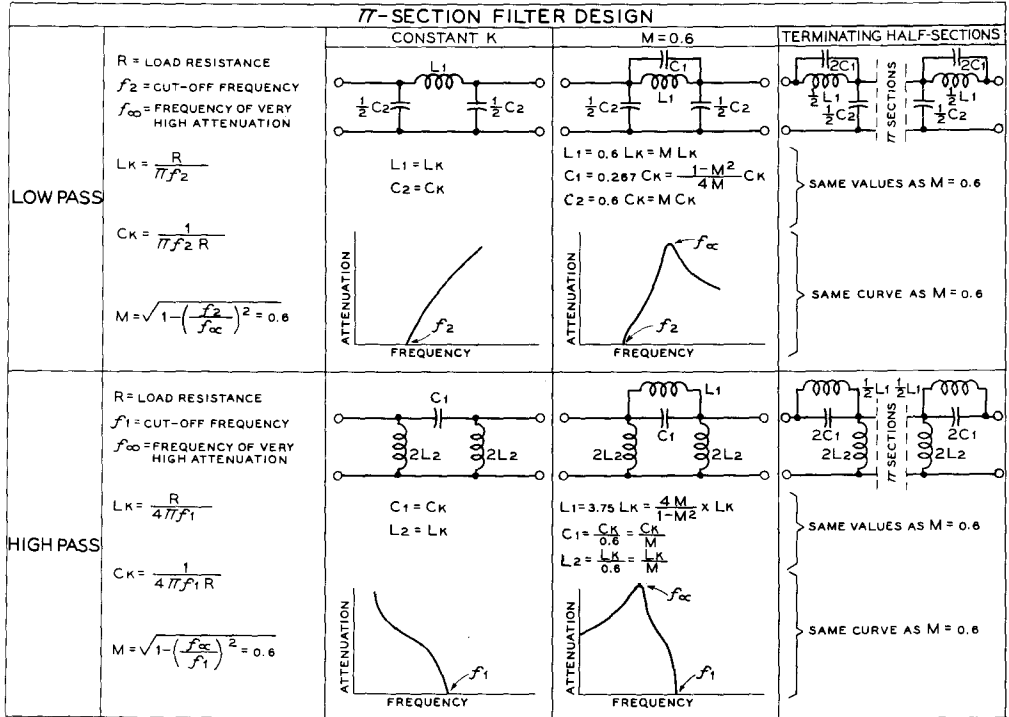

Figure 40

Through the use of the curves and equations which accompany the diagrams in the illustration above it is possible to determine the correct values of inductance and capacitance for the usual types of pi-section filters.

have some value between zero and one. As the value of m approaches zero, the sharpness of cutoff increases, but the less will be the attenuation at several times cutoff frequency. A value of 0.6 may be used for m in most applications. The "notch" frequency is determined by the resonant frequency of the tuned filter element. The amount of attenuation obtained at the "notch" when a derived section is used is determined by the effective Q of the resonant arm (figure 39).

Filter Assembly Constant-K sections and derived sections may be cascaded to obtain the combined characteristics of sharp cutoff and good remote frequency attenuation. Such a filter is known as a *composite* filter. The amount of attenuation will depend upon the number of filter sections used, and the shape of the transmission curve depends upon the type of filter sections used. All filters have some *insertion loss*. This attenuation is usually uniform to all frequen-

cies within the pass band. The insertion loss varies with the type of filter, the Q of the components and the type of termination employed.

Electric Filter Design Electric wave filters have long been used in some amateur stations in the audio channel to reduce the transmission of unwanted high frequencies and hence to reduce the bandwidth occupied by a radiophone signal. The effectiveness of a properly designed and properly used filter circuit in reducing QRM and side-band splatter should not be underestimated.

In recent years, high frequency filters have become commonplace in TVI reduction. High-pass type filters are placed before the input stage of television receivers to reject the fundamental signal of low frequency transmitters. Low-pass filters are used in the output circuits of low frequency transmitters to prevent harmonics of the transmitter from being radiated in the television channels.

The chart of figure 40 gives design data and procedure on the pi-section type of filter. M-derived sections with an M of 0.6 will be found to be most satisfactory as the input section (or half-section) of the usual filter since the input impedance of such a section

is most constant over the pass band of the filter section.

Simple filters may use either L, T, or π sections. Since the π section is the more commonly used type figure 40 gives design data and characteristics for this type of filter.

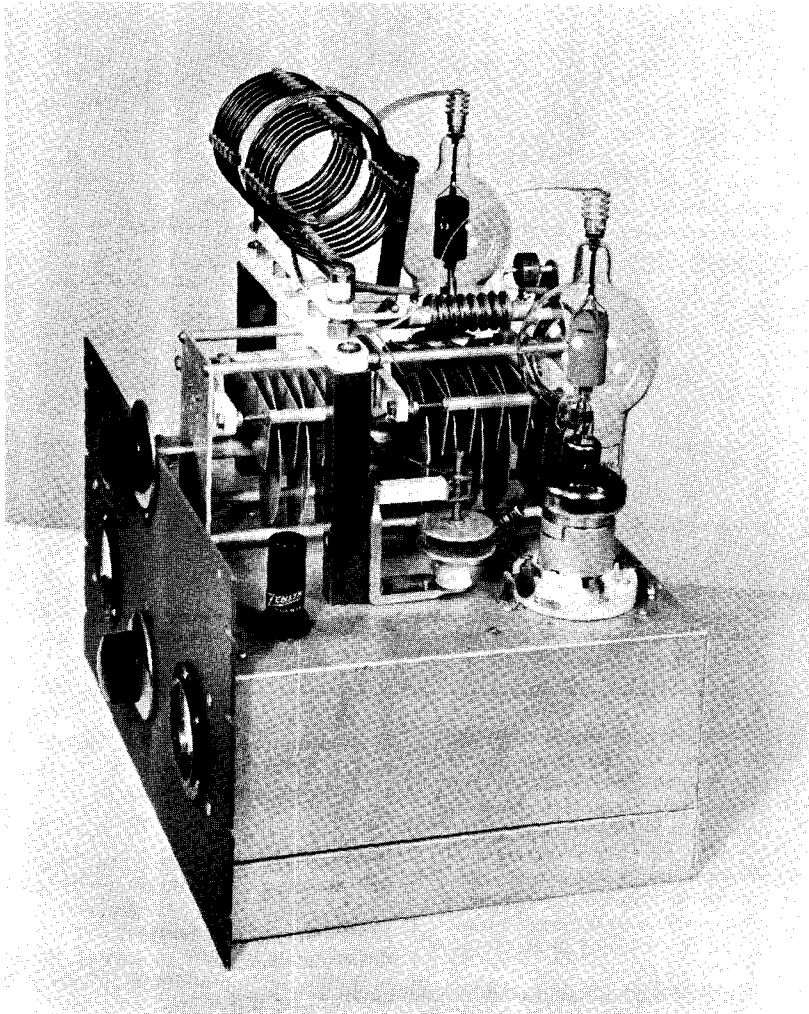

A PUSH-PULL 250-TH AMPLIFIER WITH TVI SHIELD REMOVED

Use of harmonic filters in power leads and antenna circuit reduces radiation of TVI-producing harmonics of typical push-pull amplifier. Shielded enclosure completes harmonic reduction measures.

Vacuum Tube Principles

In the previous chapters we have seen the manner in which an electric current flows through a metallic conductor as a result of an electron drift. This drift, which takes place when there is a difference in potential between the ends of the metallic conductor, is in addition to the normal random electron motion between the molecules of the conductor.

The electron may be considered as a minute negatively charged particle, having a mass of 9×10^{-28} gram, and a charge of 1.59×10^{-19} coulomb. Electrons are always identical, regardless of the source from which they are obtained.

An electric current can be caused to flow through other media than a metallic conductor. One such medium is an ionized solution, such as the sulfuric acid electrolyte in a storage battery. This type of current flow is called *electrolytic conduction*. Further, it was shown at about the turn of the century that an electric current can be carried by a stream of free electrons in an evacuated chamber. The flow of a current in such a manner is said to take place by *electronic conduction*. The study of electron tubes (also called vacuum tubes, or valves) is actually the study of the control and use of electronic currents within an evacuated or partially evacuated chamber.

Since the current flow in an electron tube takes place in an evacuated chamber, there must be located within the enclosure both a source of electrons and a collector for the electrons which have been emitted. The electron source is called the *cathode*, and the electron collector is usually called the *anode*. Some external source of energy must be applied to the cathode in order to impart sufficient velocity to the electrons within the cathode material to enable them to overcome the surface forces and thus escape into the surrounding medium. In the usual types of

electron tubes the cathode energy is applied in the form of heat; electron emission from a heated cathode is called *thermionic emission*. In another common type of electron tube, the photoelectric cell, energy in the form of light is applied to the cathode to cause *photoelectric emission*.

4-1 Thermionic Emission

Electron Emission Emission of electrons from the cathode of a thermionic electron tube takes place when the cathode of the tube is heated to a temperature sufficiently high that the free electrons in the emitter have sufficient velocity to overcome the restraining forces at the surface of the material. These surface forces vary greatly with different materials. Hence different types of cathodes must be raised to different temperatures to obtain adequate quantities of electron emission. The several types of emitters found in common types of transmitting and receiving tubes will be described in the following paragraphs.

Cathode Types The emitters or cathodes as used in present-day thermionic electron tubes may be classified into two groups: the directly-heated or *filament type* and the indirectly-heated or *heater-cathode type*. Directly-heated emitters may be further subdivided into three important groups, all of which are commonly used in modern vacuum tubes. These classifications are: the tungsten filament, the thoriated-tungsten filament, and the oxide-coated filament.

The Pure Tungsten Filament Pure tungsten wire was used as the filament in nearly all the earlier transmitting and

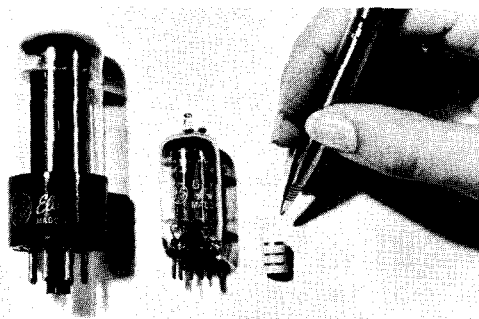

Figure 1

ELECTRON TUBE TYPES

The new General Electric ceramic triode (6BY4) is shown alongside a conventional miniature tube (6265) and an octal-based receiving tube (25L6). The ceramic tube is designed for rugged service and features extremely low lead inductance.

receiving tubes. However, the thermionic efficiency of tungsten wire as an emitter (the number of milliamperes emission per watt of filament heating power) is quite low, the filaments become fragile after use, their life is rather short, and they are susceptible to burn-out at any time. Pure tungsten filaments must be run at bright white heat (about 2500° Kelvin). For these reasons, tungsten filaments have been replaced in all applications where another type of filament could be used. They are, however, still universally employed in large water-cooled tubes and in certain large, high-power air-cooled triodes where another filament type would be unsuitable. Tungsten filaments are the most satisfactory for high-power, high-voltage tubes where the emitter is subjected to positive ion bombardment caused by the residual gas content of the tubes. Tungsten is not adversely affected by such bombardment.

The Thoriated-Tungsten Filament In the course of experiments made upon tungsten emitters, it was found that filaments made from tungsten having a small amount of thoria (thorium oxide) as an impurity had much greater emission than those made from the pure metal. Subsequent development has resulted in the highly efficient carburized thoriated-tungsten filament as used in virtually all medium-power transmitting tubes today.

Thoriated-tungsten emitters consist of a tungsten wire containing from 1% to 2% thoria. The activation process varies between different manufacturers of vacuum tubes, but it is essentially as follows: (1) the tube is evacuated; (2) the filament is burned for a short period at about 2800° Kelvin to clean the surface and reduce some of the thoria within the filament to metallic thorium; (3)

the filament is burned for a longer period at about 2100° Kelvin to form a layer of thorium on the surface of the tungsten; (4) the temperature is reduced to about 1600° Kelvin and some pure hydrocarbon gas is admitted to form a layer of tungsten carbide on the surface of the tungsten. This layer of tungsten carbide reduces the rate of thorium evaporation from the surface at the normal operating temperature of the filament and thus increases the operating life of the vacuum tube. Thorium evaporation from the surface is a natural consequence of the operation of the thoriated-tungsten filament. The carburized layer on the tungsten wire plays another role in acting as a reducing agent to produce new thorium from the thoria to replace that lost by evaporation. This new thorium continually diffuses to the surface during the normal operation of the filament. The last process, (5), in the activation of a thoriated tungsten filament consists of re-evacuating the envelope and then burning or ageing the new filament for a considerable period of time at the normal operating temperature of approximately 1900° K.

One thing to remember about any type of filament, particularly the thoriated type, is that the emitter deteriorates practically as fast when "standing by" (no plate current) as it does with any normal amount of emission load. Also, a thoriated filament may be either temporarily or permanently damaged by a heavy overload which may strip the surface layer of thorium from the filament.

Reactivating Thoriated-Tungsten Filaments Thoriated-tungsten filaments (and *only* thoriated-tungsten filaments) which have lost emission as a result of insufficient filament voltage, a severe temporary overload, a less severe extended overload, or even normal operation

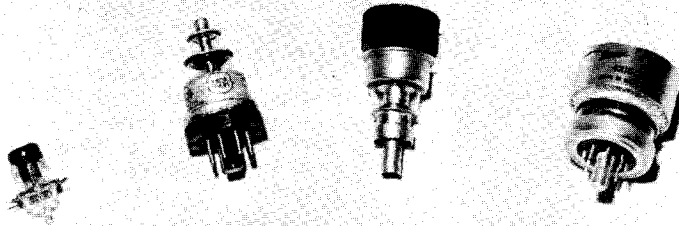

Figure 2

V-H-F and U-H-F TUBE TYPES

The tube to the left in this photograph is a 955 "acorn" triode. The 6F4 acorn triode is very similar in appearance to the 955 but has two leads brought out each for the grid and for the plate connection. The second tube is a 446A "lighthouse" triode. The 2C40, 2C43, and 2C44 are more recent examples of the same type tube and are essentially the same in external appearance. The third tube from the left is a 2C39 "oilcan" tube. This tube type is essentially the inverse of the lighthouse variety since the cathode and heater connections come out the small end and the plate is the large finned radiator on the large end. The use of the finned plate radiator makes the oilcan tube capable of approximately 10 times as much plate dissipation as the lighthouse type. The tube to the right is the 4X150A beam tetrode. This tube, a comparatively recent release, is capable of somewhat greater power output than any of the other tube types shown, and is rated for full output at 500 Mc. and at reduced output at frequencies greater than 1000 Mc.

may quite frequently be reactivated to their original characteristics by a process similar to that of the original activation. However, only filaments which have not approached too close to the end of their useful life may be successfully reactivated.

The actual process of reactivation is relatively simple. The tube which has gone "flat" is placed in a socket to which only the two filament wires have been connected. The filament is then "flashed" for about 20 to 40 seconds at about $1\frac{1}{2}$ times normal rated voltage. The filament will become extremely bright during this time and, if there is still some thoria left in the tungsten and if the tube did not originally fail as a result of an air leak, some of this thoria will be reduced to metallic thorium. The filament is then burned at 15 to 25 per cent overvoltage for from 30 minutes to 3 to 4 hours to bring this new thorium to the surface.

The tube should then be tested to see if it shows signs of renewed life. If it does, but is still weak, the burning process should be continued at about 10 to 15 per cent overvoltage for a few more hours. This should bring it back almost to normal. If the tube checks still very low after the first attempt at reactivation, the complete process can be repeated as a last effort.

The Oxide-Coated Filament The most efficient of all modern filaments is the oxide-coated type which con-

sists of a mixture of barium and strontium oxides coated upon a nickel alloy wire or strip. This type of filament operates at a dull-red to orange-red temperature (1050° to 1170° K) at which temperature it will emit large quantities of electrons. The oxide-coated filament is somewhat more efficient than the thoriated-tungsten type in small sizes and it is considerably less expensive to manufacture. For this reason all receiving tubes and quite a number of the low-powered transmitting tubes use the oxide-coated filament. Another advantage of the oxide-coated emitter is its extremely long life — the average tube can be expected to run from 3000 to 5000 hours, and when loaded very lightly, tubes of this type have been known to give 50,000 hours of life before their characteristics changed to any great extent.

Oxide filaments are unsatisfactory for use at high continuous plate voltages because: (1) their activity is seriously impaired by the high temperature necessary to de-gas the high-voltage tubes and, (2) the positive ion bombardment which takes place even in the best evacuated high-voltage tube causes destruction of the oxide layer on the surface of the filament.

Oxide-coated emitters have been found capable of emitting an enormously large current pulse with a high applied voltage for a very short period of time without damage. This characteristic has proved to be of great value

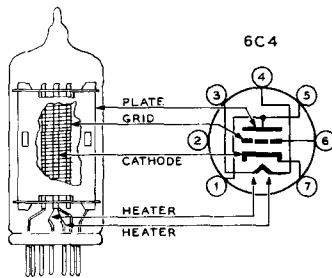

Figure 3
CUT-AWAY DRAWING OF A 6C4 TRIODE

in radar work. For example, the relatively small cathode in a microwave magnetron may be called upon to deliver 25 to 50 amperes at an applied voltage of perhaps 25,000 volts for a period in the order of one microsecond. After this large current pulse has been passed, plate voltage normally will be removed for 1000 microseconds or more so that the cathode surface may be restored in time for the next pulse of current. If the cathode were to be subjected to a continuous current drain of this magnitude, it would be destroyed in an exceedingly short period of time.

The activation of oxide-coated filaments also varies with tube manufacturers but consists essentially in heating the wire which has been coated with a mixture of barium and strontium carbonates to a temperature of about 1500° Kelvin for a time and then applying a potential of 100 to 200 volts through a protective resistor to limit the emission current. This process reduces the carbonates to oxides thermally, cleans the filament surface of foreign materials, and activates the cathode surface.

Reactivation of oxide-coated filaments is not possible since there is always more than sufficient reduction of the oxides and diffusion of the metals to the surface of the filament to meet the emission needs of the cathode.

The Heater Cathode The heater type cathode was developed as a result of the requirement for a type of emitter which could be operated from alternating current and yet would not introduce a-c ripple modulation even when used in low-level stages. It consists essentially of a small nickel-alloy cylinder with a coating of strontium and barium oxides on its surface similar to the coating used on the oxide-coated filament. Inside the cylinder is an insulated heater element consisting usually of a double spiral of tungsten wire. The heater may operate on any volt-

age from 2 to 117 volts, although 6.3 is the most common value. The heater is operated at quite a high temperature so that the cathode itself usually may be brought to operating temperature in a matter of 15 to 30 seconds. Heat-coupling between the heater and the cathode is mainly by radiation, although there is some thermal conduction through the insulating coating on the heater wire, as this coating is also in contact with the cathode thimble.

Indirectly heated cathodes are employed in all a-c operated tubes which are designed to operate at a low level either for r-f or a-f use. However, some receiver power tubes use heater cathodes (6L6, 6V6, 6F6, and 6K6-GT) as do some of the low-power transmitter tubes (802, 807, 815, 3E29, 2E26, 5763, etc.). Heater cathodes are employed almost exclusively when a number of tubes are to be operated in series as in an a.c.-d.c. receiver. A heater cathode is often called a *uni-potential cathode* because there is no voltage drop along its length as there is in the directly-heated or filament cathode.

The Bombardment Cathode A special bombardment cathode is employed in many of the new high powered television transmitting klystrons (Eimac 3K 20,000 LA). The cathode takes the form of a tantalum diode, heated to operating temperature by the bombardment of electrons from a directly heated filament. The cathode operates at a positive potential of 2000 volts with respect to the filament, and a d-c bombardment current of 0.66 amperes flows between filament and cathode. The filament is designed to operate under space-charge limited conditions. Cathode temperature is varied by changing the bombardment potential between the filament and the cathode.

The Emission Equation The emission of electrons from a heated cathode is quite similar to the evaporation of molecules from the surface of a liquid. The molecules which leave the surface are those having sufficient kinetic (heat) energy to overcome the forces at the surface of the liquid. As the temperature of the liquid is raised, the average velocity of the molecules is increased, and a greater number of molecules will acquire sufficient energy to be evaporated. The evaporation of electrons from the surface of a thermionic emitter is similarly a function of average electron velocity, and hence is a function of the temperature of the emitter.

Electron emission per unit area of emitting surface is a function of the temperature T in degrees Kelvin, the work function of the emitting surface b (which is a measure of the

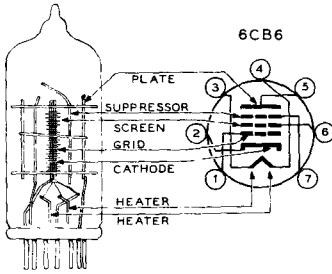

Figure 4
CUT-AWAY DRAWING OF A 6CB6 PENTODE

surface forces of the material and hence of the energy required of the electron before it may escape), and of the constant A which also varies with the emitting surface. The relationship between emission current in amperes per square centimeter, I , and the above quantities can be expressed as:

$$I = AT^2 e^{-b/T}$$

Secondary Emission The bombarding of most metals and a few insulators by electrons will result in the emission of other electrons by a process called *secondary emission*. The secondary electrons are literally knocked from the surface layers of the bombarded material by the primary electrons which strike the material. The number of secondary electrons emitted per primary electron varies from a very small percentage to as high as 5 to 10 secondary electrons per primary.

The phenomena of secondary emission is undesirable for most thermionic electron tubes. However, the process is used to advantage in certain types of electron tubes such as the image orthicon (TV camera tube) and the electron-multiplier type of photo-electric cell. In types of electron tubes which make use of secondary emission, such as the type 931 photo cell, the secondary-electron-emitting surfaces are specially treated to provide a high ratio of secondary to primary electrons. Thus a high degree of current amplification in the electron-multiplier section of the tube is obtained.

The Space Charge Effect As a cathode is heated so that it begins to emit, those electrons which have been discharged into the surrounding space form a negatively charged cloud in the immediate vicinity of the cathode. This cloud of electrons around the cathode is called the *space charge*. The electrons comprising the charge are continuously changing, since those electrons making up the original charge fall back into

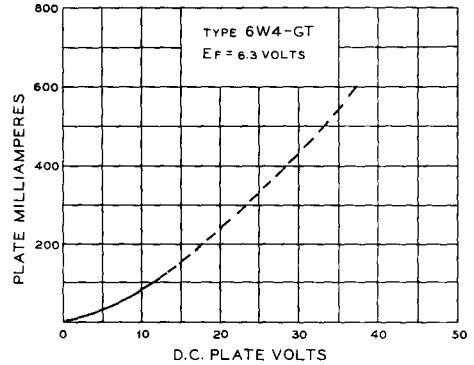

Figure 5
AVERAGE PLATE CHARACTERISTICS
OF A POWER DIODE

the cathode and are replaced by others emitted by it.

4-2 The Diode

If a cathode capable of being heated either indirectly or directly is placed in an evacuated envelope along with a plate, such a two-element vacuum tube is called a diode. The diode is the simplest of all vacuum tubes and is the fundamental type from which all the others are derived.

Characteristics of the Diode When the cathode within a diode is heated, it will be found that a few of the electrons leaving the cathode will leave with sufficient velocity to reach the plate. If the plate is electrically connected back to the cathode, the electrons which have had sufficient velocity to arrive at the plate will flow back to the cathode through the external circuit. This small amount of initial plate current is an effect found in all two-element vacuum tubes.

If a battery or other source of d-c voltage is placed in the external circuit between the plate and cathode so that it places a positive potential on the plate, the flow of current from the cathode to plate will be increased. This is due to the strong attraction offered by the positively charged plate for any negatively charged particles (figure 5).

Space-Charge Limited Current At moderate values of plate voltage the current flow from cathode to anode is limited by the space charge of electrons around the cathode. Increased values

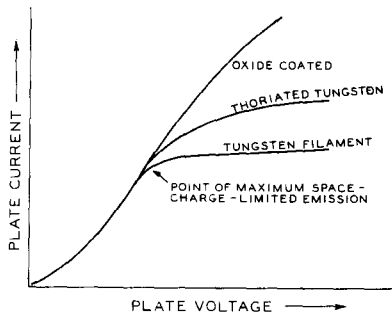

Figure 6
MAXIMUM SPACE-CHARGE-LIMITED
EMISSION FOR DIFFERENT
TYPES OF EMITTERS

of plate voltage will tend to neutralize a greater portion of the cathode space charge and hence will cause a greater current to flow.

Under these conditions, with plate current limited by the cathode space charge, the plate current is not linear with plate voltage. In fact it may be stated in general that the plate-current flow in electron tubes does not obey Ohm's Law. Rather, plate current increases as the three-halves power of the plate voltage. The relationship between plate voltage, E , and plate current, I , can be expressed as:

$$I = K E^{3/2}$$

where K is a constant determined by the geometry of the element structure within the electron tube.

Plate Current Saturation As plate voltage is raised to the potential where the cathode space charge is neutralized, all the electrons that the cathode is capable of emitting are being attracted to the plate. The electron tube is said then to have reached *saturation* plate current. Further increase in plate voltage will cause only a relatively small increase in plate current. The initial point of plate current saturation is sometimes called the point of Maximum Space-Charge-Limited Emission (MSCLE).

The degree of flattening in the plate-voltage plate-current curve after the MSCLE point will vary with different types of cathodes. This effect is shown in figure 6. The flattening is quite sharp with a pure tungsten emitter. With thoriated tungsten the flattening is smoothed somewhat, while with an oxide-coated cathode the flattening is quite gradual. The gradual saturation in emission with an oxide-coated emitter is generally considered to result from

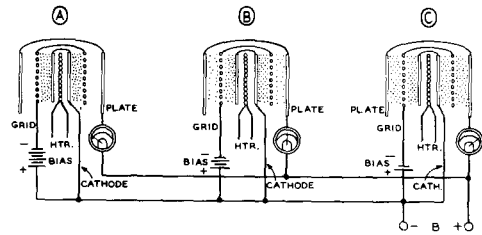

Figure 7
ACTION OF THE GRID IN A TRIODE

(A) shows the triode tube with cutoff bias on the grid. Note that all the electrons emitted by the cathode remain inside the grid mesh. (B) shows the same tube with an intermediate value of bias on the grid. Note the medium value of plate current and the fact that there is a reserve of electrons remaining within the grid mesh. (C) shows the operation with a relatively small amount of bias which with certain tube types will allow substantially all the electrons emitted by the cathode to reach the plate. Emission is said to be saturated in this case. In a majority of tube types a high value of positive grid voltage is required before plate-current saturation takes place.

a lowering of the surface work function by the field at the cathode resulting from the plate potential.

Electron Energy Dissipation The current flowing in the plate-cathode space of a conducting electron tube represents the energy required to accelerate electrons from the zero potential of the cathode space charge to the potential of the anode. Then, when these accelerated electrons strike the anode, the energy associated with their velocity is immediately released to the anode structure. In normal electron tubes this energy release appears as heating of the plate or anode structure.

4-3 The Triode

If an element consisting of a mesh or spiral of wire is inserted concentric with the plate and between the plate and the cathode, such an element will be able to control by electrostatic action the cathode-to-plate current of the tube. The new element is called a *grid*, and a vacuum tube containing a cathode, grid, and plate is commonly called a triode.

Action of the Grid If this new element through which the electrons must pass in their course from cathode to plate is made negative with respect to the cathode, the nega-

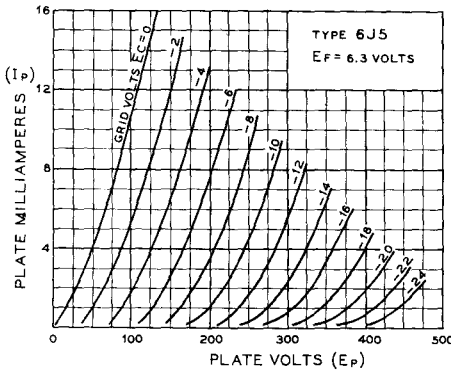

Figure 8
NEGATIVE-GRID CHARACTERISTICS (I_p VS. E_p CURVES) OF A TYPICAL TRIODE

Average plate characteristics of this type are most commonly used in determining the Class A operating characteristics of a triode amplifier stage.

negative charge on this grid will effectively repel the negatively charged electrons (like charges repel; unlike charges attract) back into the space charge surrounding the cathode. Hence, the number of electrons which are able to pass through the grid mesh and reach the plate will be reduced, and the plate current will be reduced accordingly. If the charge on the grid is made sufficiently negative, all the electrons leaving the cathode will be repelled back to it and the plate current will be reduced to zero. Any d-c voltage placed upon a grid is called a *bias* (especially so when speaking of a control grid). The smallest negative voltage which will cause cutoff of plate current at a particular plate voltage is called the value of *cutoff bias* (figure 7).

Amplification Factor The amount of plate current in a triode is a result of the net field at the cathode from interaction between the field caused by the grid bias and that caused by the plate voltage. Hence, both grid bias and plate voltage affect the plate current. In all normal tubes a small change in grid bias has a considerably greater effect than a similar change in plate voltage. The ratio between the change in grid bias and the change in plate current which will cause the same small change in plate current is called the *amplification factor* or μ of the electron tube. Expressed as an equation:

$$\mu = - \frac{\Delta E_p}{\Delta E_g}$$

with i_p constant (Δ represents a small increment).

The μ can be determined experimentally by making a small change in grid bias, thus slightly changing the plate current. The plate current is then returned to the original value by making a change in the plate voltage. The ratio of the change in plate voltage to the change in grid voltage is the μ of the tube under the operating conditions chosen for the test.

Current Flow in a Triode In a diode it was shown that the electrostatic field at the cathode was proportional to the plate potential, E_p , and that the total cathode current was proportional to the three-halves power of the plate voltage. Similarly, in a triode it can be shown that the field at the cathode space charge is proportional to the equivalent voltage ($E_g + E_p/\mu$), where the amplification factor, μ , actually represents the relative effectiveness of grid potential and plate potential in producing a field at the cathode.

It would then be expected that the cathode current in a triode would be proportional to the three-halves power of ($E_g + E_p/\mu$). The cathode current of a triode can be represented with fair accuracy by the expression:

$$\text{Cathode current} = K \left(E_g + \frac{E_p}{\mu} \right)^{3/2}$$

where K is a constant determined by element geometry within the triode.

Plate Resistance The *plate resistance* of a vacuum tube is the ratio of a change in plate voltage to the change in plate current which the change in plate voltage produces. To be accurate, the changes should be very small with respect to the operating values. Expressed as an equation:

$$R_p = \frac{\Delta E_p}{\Delta I_p} \quad E_g = \text{constant}, \Delta = \text{small increment}$$

The plate resistance can also be determined by the experiment mentioned above. By noting the change in plate current as it occurs when the plate voltage is changed (grid voltage held constant), and by dividing the latter by the former, the plate resistance can be determined. Plate resistance is expressed in Ohms.

Transconductance The mutual conductance, also referred to as *transconductance*, is the ratio of a change in the plate current to the change in grid voltage which brought about the plate current change, the plate voltage being held constant. Expressed as an equation:

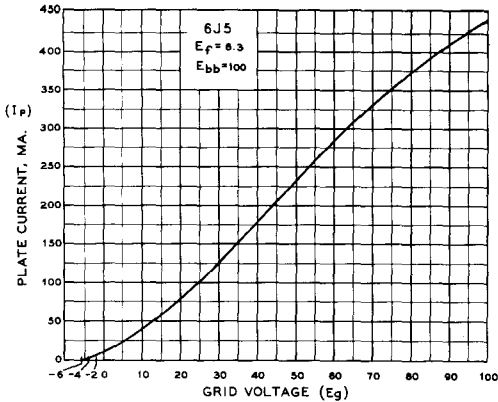

Figure 9

**POSITIVE-GRID CHARACTERISTICS
(I_p VS. E_g) OF A TYPICAL TRIODE**

Plate characteristics of this type are most commonly used in determining the pulse-signal operating characteristics of a triode amplifier stage. Note the large emission capability of the oxide-coated heater cathode in tubes of the general type of the 6J5.

$$G_m = \frac{\Delta I_p}{\Delta E_g} \quad E_p = \text{constant}, \Delta = \text{small increment}$$

The transconductance is also numerically equal to the amplification factor divided by the plate resistance. $G_m = \mu / R_p$.

Transconductance is most commonly expressed in microreciprocal-ohms or *micromhos*. However, since transconductance expresses change in plate current as a function of a change in grid voltage, a tube is often said to have a transconductance of so many milliamperes-per-volt. If the transconductance in milliamperes-per-volt is multiplied by 1000 it will then be expressed in micromhos. Thus the transconductance of a 6A3 could be called either 5.25 ma./volt or 5250 micromhos.

Characteristic Curves of a Triode Tube The operating characteristics of a triode tube may be summarized in three sets of curves: The I_p vs. E_p curve (figure 8), the I_p vs. E_g curve (figure 9) and the E_p vs. E_g curve (figure 10). The plate resistance (R_p) of the tube may be observed from the I_p vs. E_p curve, the transconductance (G_m) may be observed from the I_p vs. E_g curve, and the amplification factor (μ) may be determined from the E_p vs. E_g curve.

The Load Line A load line is a graphical representation of the voltage on the plate of a vacuum tube, and the current

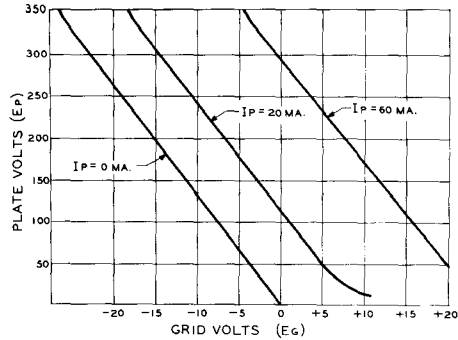

Figure 10
**CONSTANT CURRENT (E_p VS. E_g)
CHARACTERISTICS OF A
TYPICAL TRIODE TUBE**

This type of graphical representation is used for Class C amplifier calculations since the operating characteristic of a Class C amplifier is a straight line when drawn upon a constant current graph.

passing through the plate circuit of the tube for various values of plate-load resistance and plate-supply voltage. Figure 11 illustrates a triode tube with a resistive plate load, and a supply voltage of 300 volts. The voltage at the plate of the tube (e_p) may be expressed as:

$$e_p = E_p - (i_p \times R_L)$$

where E_p is the plate supply voltage, i_p is the plate current, and R_L is the load resistance in ohms.

Assuming various values of i_p flowing in the circuit, controlled by the internal resistance of the tube, (a function of the grid bias) values of plate voltage may be plotted as shown for each value of plate current (i_p). The line connecting these points is called the *load line* for the particular value of plate-load resistance used. The *slope* of the load line is equal to the ratio of the lengths of the vertical and horizontal projections of any segment of the load line. For this example it is:

$$\text{Slope} = \frac{.01 - .02}{100 - 200} = -.0001 = -\frac{1}{10,000}$$

The slope of the load line is equal to $-1/R_L$. At point A on the load line, the voltage across the tube is zero. This would be true for a perfect tube with zero internal voltage drop, or if the tube is short-circuited from cathode to plate. Point B on the load line corresponds to the cutoff point of the tube, where no plate current is flowing. The operating range of the tube lies between these two extremes. For additional information re-

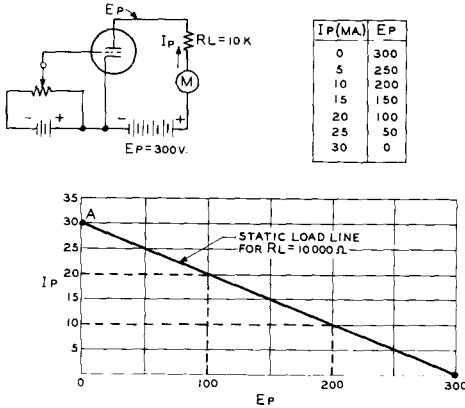

Figure 11

The static load line for a typical triode tube with a plate load resistance of 10,000 ohms.

Regarding dynamic load lines, the reader is referred to the *Radiotron Designer's Handbook*, 4th edition, distributed by Radio Corporation of America.

Application of Tube Characteristics As an example of the application of tube characteristics, the constants of the triode amplifier circuit shown in figure 12 may be considered. The plate supply is

Figure 12
TRIODE TUBE CONNECTED FOR DETERMINATION OF PLATE CIRCUIT LOAD LINE, AND OPERATING PARAMETERS OF THE CIRCUIT

300 volts, and the plate load is 8,000 ohms. If the tube is considered to be an open circuit no plate current will flow, and there is no voltage drop across the plate load resistor, R_L . The plate voltage on the tube is therefore 300 volts. If, on the other hand, the tube is considered to be a short circuit, maximum possible plate current flows and the full 300 volt drop appears across R_L . The plate voltage is zero, and the plate current is $300/8,000$, or 37.5 milliamperes. These two extreme conditions define the load line on the I_p vs. E_p characteristic curve, figure 13.

For this application the grid of the tube is returned to a steady biasing voltage of -4 volts. The steady or quiescent operation of the tube is determined by the intersection of the load line with the -4 volt curve at point Q. By projection from point Q through the plate

Figure 13
APPLICATION OF I_p VS. E_p CHARACTERISTICS OF VACUUM TUBE

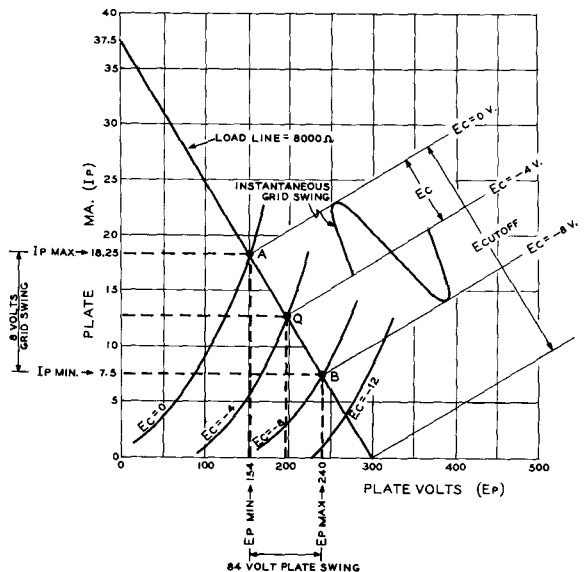

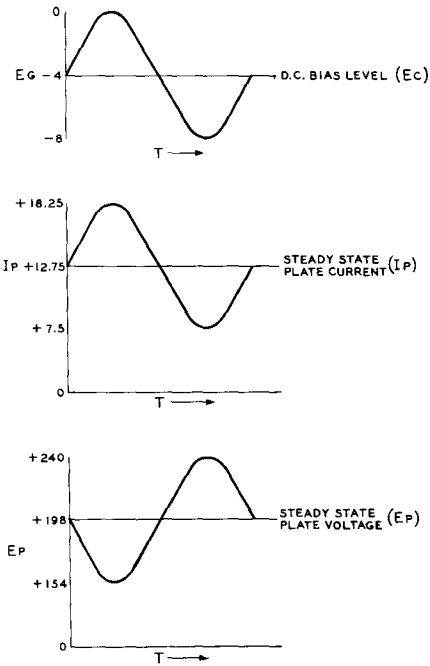

Figure 14
POLARITY REVERSAL BETWEEN GRID
AND PLATE VOLTAGES

current axis it is found that the value of plate current with no signal applied to the grid is 12.75 milliamperes. By projection from point Q through the plate voltage axis it is found that the quiescent plate voltage is 198 volts. This leaves a drop of 102 volts across R_L which is borne out by the relation $0.01275 \times 8,000 = 102$ volts.

An alternating voltage of 4 volts maximum swing about the normal bias value of -4 volts is applied now to the grid of the triode amplifier. This signal swings the grid in a positive direction to 0 volts, and in a negative direction to -8 volts, and establishes the *operating region* of the tube along the load line between points A and B. Thus the maxima and minima of the plate voltage and plate current are established. By projection from points A and B through the plate current axis the maximum instantaneous plate current is found to be 18.25 milliamperes and the minimum is 7.5 milliamperes. By projections from points A and B through the plate voltage axis the minimum instantaneous plate voltage swing is found to be 154 volts and the maximum is 240 volts.

By this graphical application of the I_p vs. E_p characteristic of the 6SN7 triode the operation of the circuit illustrated in figure 12 be-

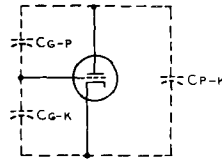

Figure 15
SCHEMATIC REPRESENTATION
OF INTERELECTRODE
CAPACITANCE

comes apparent. A voltage variation of 8 volts (peak-to-peak) on the grid produces a variation of 84 volts at the plate.

Polarity Inversion When the signal voltage applied to the grid has its maximum positive instantaneous value the plate current is also maximum. Reference to figure 12 shows that this maximum plate current flows through the plate load resistor R_L , producing a maximum voltage drop across it. The lower end of R_L is connected to the plate supply, and is therefore held at a constant potential of 300 volts. With maximum voltage drop across the load resistor, the upper end of R_L is at a minimum instantaneous voltage. The plate of the tube is connected to this end of R_L and is therefore at the same minimum instantaneous potential.

This polarity reversal between instantaneous grid and plate voltages is further clarified by a consideration of Kirchhoff's law as it applies to series resistance. The sum of the IR drops around the plate circuit must at all times equal the supply voltage of 300 volts. Thus when the instantaneous voltage drop across R_L is maximum, the voltage drop across the tube is minimum, and their sum must equal 300 volts. The variations of grid voltage, plate current and plate voltage about their steady state values is illustrated in figure 14.

Interelectrode Capacitance always exists between any two pieces of metal separated by a dielectric. The exact amount of capacitance depends upon the size of the metal pieces, the dielectric between them, and the type of dielectric. The electrodes of a vacuum tube have a similar characteristic known as the *interelectrode capacitance*, illustrated in figure 15. These direct capacities in a triode are: grid-to-cathode capacitance, grid-to-plate capacitance, and plate-to-cathode capacitance. The interelectrode capacitance, though very small, has a coupling effect, and often can cause unbalance in a particular circuit. At very high

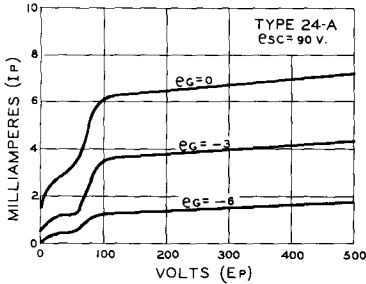

Figure 16

TYPICAL I_p VS. E_p TETRODE
CHARACTERISTIC CURVES

Figure 17

TYPICAL I_p VS. E_p PENTODE
CHARACTERISTIC CURVES

frequencies (v-h-f), interelectrode capacities become very objectionable and prevent the use of conventional tubes at these frequencies. Special v-h-f tubes must be used which are characterized by very small electrodes and close internal spacing of the elements of the tube.

4-4 Tetrode or Screen Grid Tubes

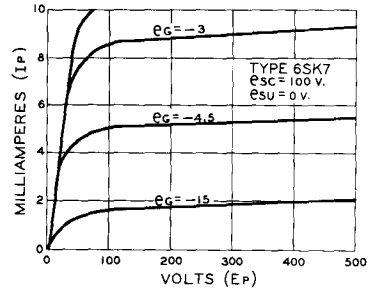
Many desirable characteristics can be obtained in a vacuum tube by the use of more than one grid. The most common multi-element tube is the tetrode (four electrodes). Other tubes containing as many as eight electrodes are available for special applications.

The Tetrode The quest for a simple and easily usable method of eliminating the effects of the grid-to-plate capacitance of the triode led to the development of the *screen-grid* tube or *tetrode*. When another grid is added between the grid and plate of a vacuum tube the tube is called a tetrode, and because the new grid is called a *screen*, as a result of its screening or shielding action, the tube is often called a screen-grid tube. The interposed screen grid acts as an electrostatic shield between the grid and plate, with the consequence that the grid-to-plate capacitance is reduced. Although the screen grid is maintained at a positive voltage with respect to the cathode of the tube, it is maintained at ground potential with respect to r.f. by means of a by-pass capacitor of very low reactance at the frequency of operation.

In addition to the shielding effect, the screen grid serves another very useful purpose. Since the screen is maintained at a positive potential, it serves to increase or accelerate the flow of electrons to the plate. There being large openings in the screen mesh, most of

the electrons pass through it and on to the plate. Due also to the screen, the plate current is largely independent of plate voltage, thus making for high amplification. When the screen voltage is held at a constant value, it is possible to make large changes in plate voltage without appreciably affecting the plate current, (figure 16).

When the electrons from the cathode approach the plate with sufficient velocity, they dislodge electrons upon striking the plate. This effect of *bombarding* the plate with high velocity electrons, with the consequent dislodgement of other electrons from the plate, gives rise to the condition of secondary emission which has been discussed in a previous paragraph. This effect can cause no particular difficulty in a triode because the secondary electrons so emitted are eventually attracted back to the plate. In the screen-grid tube, however, the screen is close to the plate and is maintained at a positive potential. Thus, the screen will attract these electrons which have been knocked from the plate, particularly when the plate voltage falls to a lower value than the screen voltage, with the result that the plate current is lowered and the amplification is decreased.

In the application of tetrodes, it is necessary to operate the plate at a high voltage in relation to the screen in order to overcome these effects of *secondary emission*.

The Pentode The undesirable effects of secondary emission from the plate can be greatly reduced if yet another element is added between the screen and plate. This additional element is called a *suppressor*, and tubes in which it is used are called *pentodes*. The suppressor grid is sometimes connected to the cathode within the tube; sometimes it is brought out to a connecting pin on the tube base, but in any case it is established nega-

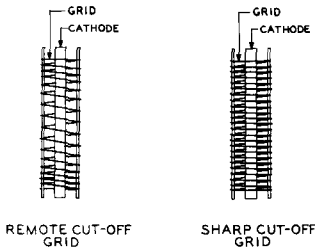

Figure 18
REMOTE CUTOFF GRID STRUCTURE

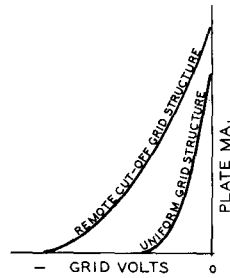

Figure 19
ACTION OF A REMOTE CUTOFF
GRID STRUCTURE

tive with respect to the minimum plate voltage. The secondary electrons that would travel to the screen if there were no suppressor are diverted back to the plate. The plate current is, therefore, not reduced and the amplification possibilities are increased (figure 17).

Pentodes for audio applications are designed so that the suppressor increases the limits to which the plate voltage may swing; therefore the consequent power output and gain can be very great. Pentodes for radio-frequency service function in such a manner that the suppressor allows high voltage gain, at the same time permitting fairly high gain at low plate voltage. This holds true even if the plate voltage is the same or slightly lower than the screen voltage.

Remote Cutoff Tubes *Remote cutoff* tubes (variable μ) are screen grid tubes in which the control grid structure has been physically modified so as to cause the plate current of the tube to drop off gradually, rather than to have a well defined cutoff point (figure 18). A non-uniform control grid structure is used, so that the amplification factor is different for different parts of the control grid.

Remote cutoff tubes are used in circuits where it is desired to control the amplification by varying the control grid bias. The characteristic curve of an ordinary screen grid tube has considerable curvature near the plate current cutoff point, while the curve of a remote cutoff tube is much more linear (figure 19). The remote cutoff tube minimizes cross-talk interference that would otherwise be produced. Examples of remote cutoff tubes are: 6BD6, 6K7, 6SG7 and 6SK7.

Beam Power Tubes A beam power tube makes use of another method for suppressing secondary emission. In this tube

there are four electrodes: a cathode, a grid, a screen, and a plate, so spaced and placed that secondary emission from the plate is suppressed without actual power loss. Because

of the manner in which the electrodes are spaced, the electrons which travel to the plate are slowed down when the plate voltage is low, almost to zero velocity in a certain region between screen and plate. For this reason the electrons form a stationary cloud, or *space charge*. The effect of this space charge is to repel secondary electrons emitted from the plate and thus cause them to return to the plate. In this way, secondary emission is suppressed.

Another feature of the beam power tube is the low current drawn by the screen. The screen and the grid are spiral wires wound so that each turn in the screen is shaded from the cathode by a grid turn. This alignment of the screen and the grid causes the electrons to travel in sheets between the turns of the screen so that very few of them strike the screen itself. This formation of the electron stream into sheets or beams increases the charge density in the screen-plate region and assists in the creation of the space charge in this region.

Because of the effective suppressor action provided by the space charge, and because of the low current drawn by the screen, the beam power tube has the advantages of high power output, high power-sensitivity, and high efficiency. The 6L6 is such a beam power tube, designed for use in the power amplifier stages of receivers and speech amplifiers or modulators. Larger tubes employing the beam-power principle are being made by various manufacturers for use in the radio-frequency stages of transmitters. These tubes feature extremely high power-sensitivity (a very small amount of driving power is required for a large output), good plate efficiency, and low grid-to-plate capacitance. Examples of these tubes are 813, 4-250A, 4X150A, etc.

Grid-Screen Mu Factor The *grid-screen mu factor* (μ_{sg}) is analogous to the amplification factor in a triode, except that the screen of a pentode or tetrode is sub-

stituted for the plate of a triode. μ_{sg} denotes the ratio of a change in grid voltage to a change in screen voltage, each of which will produce the same change in screen current. Expressed as an equation:

$$\mu_{sg} = \frac{\Delta E_{sg}}{\Delta E_g} \quad I_{sg} = \text{constant}, \Delta = \text{small increment}$$

The grid-screen mu factor is important in determining the operating bias of a tetrode or pentode tube. The relationship between control-grid potential and screen potential determines the plate current of the tube as well as the screen current since the plate current is essentially independent of the plate voltage in tubes of this type. In other words, when the tube is operated at cutoff bias as determined by the screen voltage and the grid-screen mu factor (determined in the same way as with a triode, by dividing the operating voltage by the mu factor) the plate current will be substantially at cutoff, as will be the screen current. The grid-screen mu factor is numerically equal to the amplification factor of the same tetrode or pentode tube when it is triode connected.

Current Flow in Tetrodes and Pentodes The following equation is the expression for total cathode current in a triode tube. The expression for the total cathode current of a tetrode and a pentode tube is the same, except that the screen-grid voltage and the grid-screen μ -factor are used in place of the plate voltage and μ of the triode.

$$\text{Cathode current} = K \left(E_g + \frac{E_{sg}}{\mu_{sg}} \right)^{3/2}$$

Cathode current, of course, is the sum of the screen and plate current, plus control grid current in the event that the control grid is positive with respect to the cathode. It will be noted that total cathode current is independent of plate voltage in a tetrode or pentode. Also, in the usual tetrode or pentode the plate current is substantially independent of plate voltage over the usual operating range—which means simply that the effective plate resistance of such tubes is relatively high. However, when the plate voltage falls below the normal operating range, the plate current falls sharply, while the screen current rises to such a value that the total cathode current remains substantially constant. Hence, the screen grid in a tetrode or pentode will almost invariably be damaged by excessive dissipation if the plate voltage is removed while the screen voltage is still being applied from a low-impedance source.

The Effect of Grid Current The current equations show how the total cathode current in triodes, tetrodes, and pentodes is a function of the potentials applied to the various electrodes. If only one electrode is positive with respect to the cathode (such as would be the case in a triode acting as a class A amplifier) all the cathode current goes to the plate. But when both screen and plate are positive in a tetrode or pentode, the cathode current divides between the two elements. Hence the screen current is taken from the total cathode current, while the balance goes to the plate. Further, if the control grid in a tetrode or pentode is operated at a positive potential the total cathode current is divided between all three elements which have a positive potential. In a tube which is receiving a large excitation voltage, it may be said that the control grid robs electrons from the output electrode during the period that the grid is positive, making it always necessary to limit the peak-positive excursion of the control grid.

Coefficients of Tetrodes and Pentodes In general it may be stated that the amplification factor of tetrode and pentode tubes is a coefficient which is not of much use to the designer. In fact the amplification factor is seldom given on the design data sheets of such tubes. Its value is usually very high, due to the relatively high plate resistance of such tubes, but bears little relationship to the stage gain which actually will be obtained with such tubes.

On the other hand, the *grid-plate transconductance* is the most important coefficient of pentode and tetrode tubes. Gain per stage can be computed directly when the G_m is known. The grid-plate transconductance of a tetrode or pentode tube can be calculated through use of the expression:

$$G_m = \frac{\Delta I_p}{\Delta E_g}$$

with E_{sg} and E_p constant.

The plate resistance of such tubes is of less importance than in the case of triodes, though it is often of value in determining the amount of damping a tube will exert upon the impedance in its plate circuit. Plate resistance is calculated from:

$$R_p = \frac{\Delta E_p}{\Delta I_p}$$

with E_g and E_{sg} constant.

4-5 Mixer and Converter Tubes

The superheterodyne receiver always in-

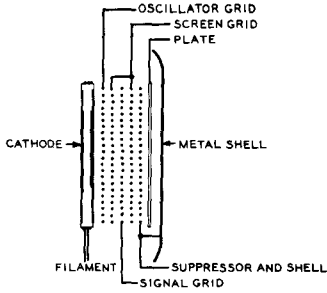

Figure 20
GRID STRUCTURE OF 6SA7
CONVERTER TUBE

cludes at least one stage for changing the frequency of the incoming signal to the fixed frequency of the main intermediate amplifier in the receiver. This frequency changing process is accomplished by selecting the beat-note difference frequency between a locally generated oscillation and the incoming signal frequency. If the oscillator signal is supplied by a separate tube, the frequency changing tube is called a *mixer*. Alternatively, the oscillation may be generated by additional elements within the frequency changer tube. In this case the frequency changer is commonly called a *converter* tube.

Conversion Conductance The *conversion conductance* (G_c) is a coefficient of interest in the case of mixer or converter tubes, or of conventional triodes, tetrodes, or pentodes operating as frequency changers. The conversion conductance is the ratio of a change in the signal-grid voltage at the input frequency to a change in the output current at the converted frequency. Hence G_c in a mixer is essentially the same as transconductance in an amplifier, with the exception that the input signal and the output current are on different frequencies. The value of G_c in conventional mixer tubes is from 300 to 1000 micromhos. The value of G_c in an amplifier tube operated as a mixer is approximately 0.3 the G_m of the tube operated as an amplifier. The voltage gain of a mixer stage is equal to $G_c Z_L$ where Z_L is the impedance of the plate load into which the mixer tube operates.

The Diode Mixer The simplest mixer tube is the diode. The noise figure, or figure of merit, for a mixer of this type is not as good as that obtained with other more complex mixers; however, the diode is useful as a mixer in u-h-f and v-h-f equipment where low interelectrode capacities are vital to circuit operation. Since the diode impedance is

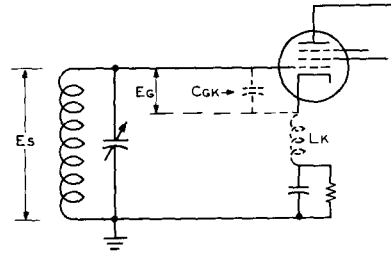

Figure 21
SHOWING THE EFFECT OF CATHODE
LEAD INDUCTANCE

The degenerative action of cathode lead inductance tends to reduce the effective grid-to-cathode voltage with respect to the voltage available across the input tuned circuit. Cathode lead inductance also introduces undesirable coupling between the input and the output circuits.

low, the local oscillator must furnish considerable power to the diode mixer. A good diode mixer has an overall gain of about 0.5.

The Triode Mixer A triode mixer has better gain and a better noise figure than the diode mixer. At low frequencies, the gain and noise figure of a triode mixer closely approaches those figures obtained when the tube is used as an amplifier. In the u-h-f and v-h-f range, the efficiency of the triode mixer deteriorates rapidly. The optimum local oscillator voltage for a triode mixer is about 0.7 as large as the cutoff bias of the triode. Very little local oscillator power is required by a triode mixer.

Pentode Mixers and Converter Tubes The most common multi-grid converter tube for broadcast or shortwave use is the *penta grid converter*, typified by the 6SA7, 6SB7-Y and 6BA7 tubes (figure 20). Operation of these converter tubes and pentode mixers will be covered in the Receiver Fundamentals Chapter.

4-6 Electron Tubes at Very High Frequencies

As the frequency of operation of the usual type of electron tube is increased above about 20 Mc., certain assumptions which are valid for operation at lower frequencies must be re-examined. First, we find that lead inductances from the socket connections to the actual elements within the envelope no longer are negligible. Second, we find that electron

transit time no longer may be ignored; an appreciable fraction of a cycle of input signal may be required for an electron to leave the cathode space charge, pass through the grid wires, and travel through the space between grid and plate.

Effects of Lead Inductance The effect of lead inductance is two-fold. First, as shown in figure 21, the combination of grid-lead inductance, grid-cathode capacitance, and cathode lead inductance tends to reduce the effective grid-cathode signal voltage for a constant voltage at the tube terminals as the frequency is increased. Second, cathode lead inductance tends to introduce undesired coupling between the various elements within the tube.

Tubes especially designed for v-h-f and u-h-f use have had their lead inductances minimized. The usual procedures for reducing lead inductance are: (1) using heavy lead conductors or several leads in parallel (examples are the 6SH7 and 6AK5), (2) scaling down the tube in all dimensions to reduce both lead inductances and interelectrode capacitances (examples are the 6AK5, 6F4, and other acorn and miniature tubes), and (3) the use of very low inductance extensions of the elements themselves as external connections (examples are lighthouse tubes such as the 2C40, oilcan tubes such as the 2C29, and many types of v-h-f transmitting tubes).

Effect of Transit Time When an electron tube is operated at a frequency high enough that electron transit time between cathode and plate is an appreciable fraction of a cycle at the input frequency, several undesirable effects take place. First, the grid takes power from the input signal even though the grid is negative at all times. This comes about since the grid will have changed its potential during the time required for an electron to pass from cathode to plate. Due to interaction, and a resulting phase difference between the field associated with the grid and that associated with a moving electron, the grid presents a resistance to an input signal in addition to its normal "cold" capacitance. Further, as a result of this action, plate current no longer is in phase with grid voltage.

An amplifier stage operating at a frequency high enough that transit time is appreciable:

- (a) Is difficult to excite as a result of grid loss from the equivalent input grid resistance,
- (b) Is capable of less output since transconductance is reduced and plate current is not in phase with grid voltage.

The effects of transit time increase with the square of the operating frequency, and they

increase rapidly as frequency is increased above the value where they become just appreciable. These effects may be reduced by scaling down tube dimensions; a procedure which also reduces lead inductance. Further, transit-time effects may be reduced by the obvious procedure of increasing electrode potentials so that electron velocity will be increased. However, due to the law of electron-motion in an electric field, transit time is increased only as the square root of the ratio of operating potential increase; therefore this expedient is of limited value due to other limitations upon operating voltages of small electron tubes.

4-7 Special Microwave Electron Tubes

Due primarily to the limitation imposed by transit time, conventional negative-grid electron tubes are capable of affording worthwhile amplification and power output only up to a definite upper frequency. This upper frequency limit varies from perhaps 100 Mc. for conventional tube types to about 4000 Mc. for specialized types such as the lighthouse tube. Above the limiting frequency, the conventional negative-grid tube no longer is practicable and recourse must be taken to totally different types of electron tubes in which electron transit time is not a limitation to operation. Three of the most important of such microwave tube types are the *klystron*, the *magnetron*, and the *travelling wave tube*.

The Power Klystron The klystron is a type of electron tube in which electron transit time is used to advantage. Such tubes comprise, as shown in figure 22, a cathode, a focussing electrode, a resonator connected to a pair of grids which afford *velocity modulation* of the electron beam (called the "buncher"), a *drift space*, and another resonator connected to a pair of grids (called the "catcher"). A *collector* for the expended electrons may be included at the end of the tube, or the catcher may also perform the function of electron collection.

The tube operates in the following manner: The cathode emits a stream of electrons which is focussed into a beam by the focussing electrode. The stream passes through the buncher where it is acted upon by any field existing between the two grids of the buncher cavity. When the potential between the two grids is zero, the stream passes through without change in velocity. But when the potential between the two grids of the buncher is increasingly positive in the direction of electron

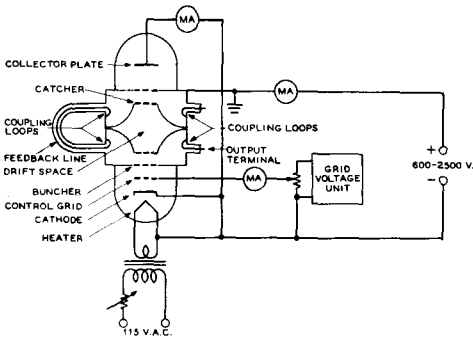

Figure 22

TWO-CAVITY KLYSTRON OSCILLATOR

A conventional two-cavity klystron is shown with a feedback loop connected between the two cavities so that the tube may be used as an oscillator.

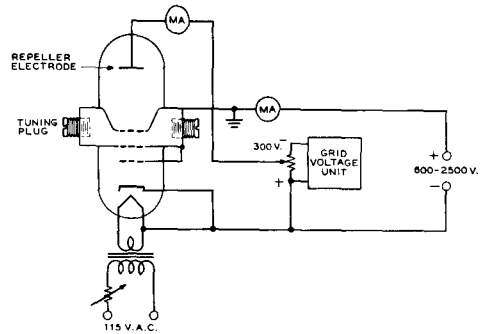

Figure 23

REFLEX KLYSTRON OSCILLATOR

A conventional reflex klystron oscillator of the type commonly used as a local oscillator in superheterodyne receivers operating above about 2000 Mc. is shown above. Frequency modulation of the output frequency of the oscillator, or a-f-c operation in a receiver, may be obtained by varying the negative voltage on the repeller electrode.

motion, the velocity of the electrons in the beam is increased. Conversely, when the field becomes increasingly negative in the direction of the beam (corresponding to the other half cycle of the exciting voltage from that which produced electron acceleration) the velocity of the electrons in the beam is decreased.

When the velocity-modulated electron beam reaches the drift space, where there is no field, those electrons which have been sped up on one half-cycle overtake those immediately ahead which were slowed down on the other half-cycle. In this way, the beam electrons become bunched together. As the bunched groups pass through the two grids of the catcher cavity, they impart pulses of energy to these grids. The catcher grid-space is charged to different voltage levels by the passing electron bunches, and a corresponding oscillating field is set up in the catcher cavity. The catcher is designed to resonate at the frequency of the velocity-modulated beam, or at a harmonic of this frequency.

In the klystron amplifier, energy delivered by the buncher to the catcher grids is greater than that applied to the buncher cavity by the input signal. In the klystron oscillator a feedback loop connects the two cavities. Coupling to either buncher or catcher is provided by small loops which enter the cavities by way of concentric lines.

The klystron is an electron-coupled device. When used as an oscillator, its output voltage is rich in harmonics. Klystron oscillators of various types afford power outputs ranging from less than 1 watt to many thousand watts. Operating efficiency varies between 5 and 30 per cent. Frequency may be shifted to some extent by varying the beam voltage. Tuning is

carried on mechanically in some klystrons by altering (by means of knob settings) the shape of the resonant cavity.

The Reflex Klystron The two-cavity klystron as described in the preceding paragraphs is primarily used as a transmitting device since quite reasonable amounts of power are made available in its output circuit. However, for applications where a much smaller amount of power is required—power levels in the milliwatt range—for low-power transmitters, receiver local oscillators, etc., another type of klystron having only a single cavity is more frequently used.

The theory of operation of the single-cavity klystron is essentially the same as the multi-cavity type with the exception that the velocity-modulated electron beam, after having left the "buncher" cavity is reflected back into the area of the buncher again by a repeller electrode as illustrated in figure 23. The potentials on the various electrodes are adjusted to the value such that proper bunching of the electron beam will take place just as a particular portion of the velocity-modulated beam reenters the area of the resonant cavity. Since this type of klystron has only one circuit it can be used only as an oscillator and not as an amplifier. Effective modulation of the frequency of a single-cavity klystron for FM work can be obtained by modulating the repeller electrode voltage.

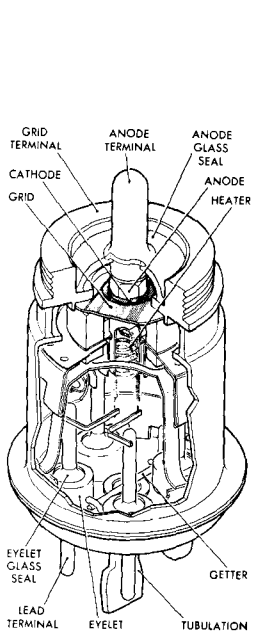

Figure 24

CUTAWAY VIEW OF

WESTERN ELECTRIC 416-B/6280
VHF PLANAR TRIODE TUBE

The 416-B, designed by the Bell Telephone Laboratories is intended for amplifier or frequency multiplier service in the 4000 mc region. Employing grid wires having a diameter equal to fifteen wavelengths of light, the 416-B has a transconductance of 50,000. Spacing between grid and cathode is .0005", to reduce transit time effects. Entire tube is gold plated.

The Magnetron The magnetron is an s-h-f oscillator tube normally employed where very high values of peak power or moderate amounts of average power are required in the range from perhaps 700 Mc. to 30,000 Mc. Special magnetrons were developed for wartime use in radar equipments which had peak power capabilities of several million watts (megawatts) output at frequencies in the vicinity of 3000 Mc. The normal duty cycle of operation of these radar equipments was approximately 1/10 of one per cent (the tube operated about 1/1000 of the time and rested for the balance of the operating period) so that the average power output of these magnetrons was in the vicinity of 1000 watts.

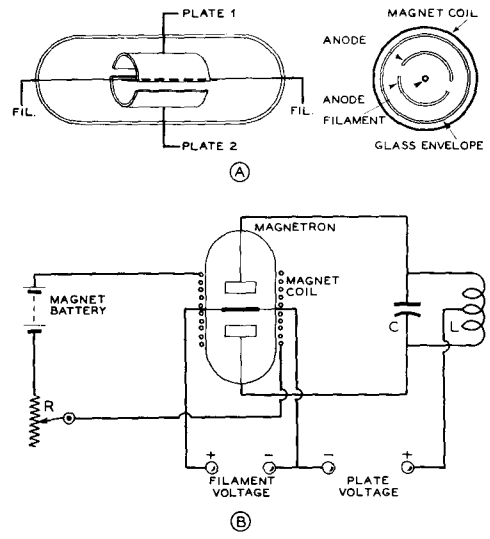

Figure 25

SIMPLE MAGNETRON OSCILLATOR

An external tank circuit is used with this type of magnetron oscillator for operation in the lower u-h-f range.

In its simplest form the magnetron tube is a filament-type diode with two half-cylindrical plates or anodes situated coaxially with respect to the filament. The construction is illustrated in figure 25A. The anodes of the magnetron are connected to a resonant circuit as illustrated on figure 25B. The tube is surrounded by an electromagnet coil which, in turn, is connected to a low-voltage d-c energizing source through a rheostat R for controlling the strength of the magnetic field. The field coil is oriented so that the lines of magnetic force it sets up are parallel to the axis of the electrodes.

Under the influence of the strong magnetic field, electrons leaving the filament are deflected from their normal paths and move in circular orbits within the anode cylinder. This effect results in a negative resistance which sustains oscillations. The oscillation frequency is very nearly the value determined by L and C. In other magnetron circuits, the frequency may be governed by the electron rotation, no external tuned circuits being employed. Wavelengths of less than 1 centimeter have been produced with such circuits.

More complex magnetron tubes employ no external tuned circuit, but utilize instead one or more resonant cavities which are integral with the anode structure. Figure 26 shows a magnetron of this type having a multi-cellular

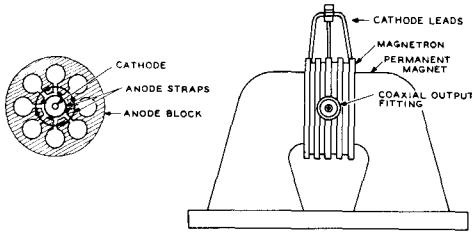

Figure 26

MODERN MULTI-CAVITY MAGNETRON

Illustrated is an external-anode strapped magnetron of the type commonly used in radar equipment for the 10-cm. range. A permanent magnet of the general type used with such a magnetron is shown in the right-hand portion of the drawing, with the magnetron in place between the pole pieces of the magnet.

anode of eight cavities. It will be noted, also, that alternate cavities (which would operate at the same polarity when the tube is oscillating) are strapped together. Strapping was found to improve the efficiency and stability of high-power radar magnetrons. In most radar applications of magnetron oscillators a powerful permanent magnet of controlled characteristics is employed to supply the magnetic field rather than the use of an electromagnet.

The Travelling Wave Tube

The *Travelling Wave Tube* (figure 27) consists of a helix located within an evacuated envelope. Input and output terminations are affixed to each end of the helix. An electron beam passes through the helix and interacts with a wave travelling along the helix to produce broad band amplification at microwave frequencies.

When the input signal is applied to the gun end of the helix, it travels along the helix wire at approximately the speed of light. However, the signal velocity measured along the axis of the helix is considerably lower. The electrons emitted by the cathode gun pass axially through the helix to the collector, located at the output end of the helix. The average velocity of the electrons depends upon the potential of the collector with respect to the cathode. When the average velocity of the electrons is greater than the velocity of the helix wave, the electrons become crowded together in the various regions of retarded field, where they impart energy to the helix wave. A power gain of 100 or more may be produced by this tube.

4-8 The Cathode-Ray Tube

The Cathode-Ray Tube The *cathode-ray tube* is a special type of

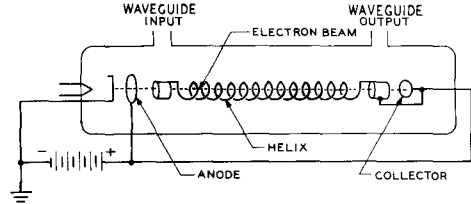

Figure 27

THE TRAVELLING WAVE TUBE

Operation of this tube is the result of interaction between the electron beam and wave travelling along the helix.

electron tube which permits the visual observation of electrical signals. It may be incorporated into an oscilloscope for use as a test instrument or it may be the display device for radar equipment or a television receiver.

Operation of the CRT

A cathode-ray tube always includes an electron gun for producing a stream of electrons, a grid for controlling the intensity of the electron beam, and a luminescent screen for converting the impinging electron beam into visible light. Such a tube always operates in conjunction with either a built-in or an external means for focussing the electron stream into a narrow beam, and a means for deflecting the electron beam in accordance with an electrical signal.

The main electrical difference between types of cathode-ray tubes lies in the means employed for focussing and deflecting the electron beam. The beam may be focussed and/or deflected either electrostatically or magnetically, since a stream of electrons can be acted upon either by an electrostatic or a magnetic field. In an electrostatic field the electron beam tends to be deflected toward the positive termination of the field (figure 28). In a magnetic field the stream tends to be deflected at right angles to the field. Further, an electron beam tends to be deflected so that it is normal (perpendicular) to the equipotential lines of an electrostatic field — and it tends to be deflected so that it is parallel to the lines of force in a magnetic field.

Large cathode-ray tubes used as *kinescopes* in television receivers usually are both focused and deflected magnetically. On the other hand, the medium-size CR tubes used in oscilloscopes and small television receivers usually are both focused and deflected electrostatically. But CR tubes for special applications may be focused magnetically and deflected electrostatically or vice versa.

There are advantages and disadvantages to

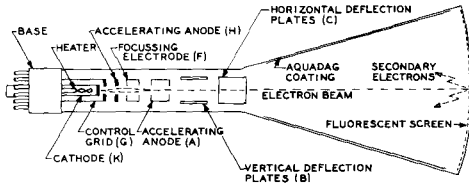

Figure 28
TYPICAL ELECTROSTATIC
CATHODE-RAY TUBE

both types of focussing and deflection. However, it may be stated that electrostatic deflection is much better than magnetic deflection when high-frequency waves are to be displayed on the screen; hence the almost universal use of this type of deflection for oscillographic work. But when a tube is operated at a high value of accelerating potential so as to obtain a bright display on the face of the tube as for television or radar work, the use of magnetic deflection becomes desirable since it is relatively easier to deflect a high-velocity electron beam magnetically than electrostatically. However, an *ion trap* is required with magnetic deflection since the heavy negative ions emitted by the cathode are not materially deflected by the magnetic field and hence would burn an "ion spot" in the center of the luminescent screen. With electrostatic deflection the heavy ions are deflected equally as well as the electrons in the beam so that an ion spot is not formed.

Construction of Electrostatic CRT The construction of a typical electrostatic-focus, electrostatic-deflection cathode-ray tube is illustrated in the pictorial diagram of figure 28. The *indirectly heated cathode* K releases free electrons when heated by the enclosed filament. The cathode is surrounded by a cylinder G, which has a small hole in its front for the passage of the electron stream. Although this element is not a wire mesh as is the usual grid, it is known by the same name because its action is similar: it controls the electron stream when its negative potential is varied.

Next in order, is found the first *accelerating anode*, H, which resembles another disk or cylinder with a small hole in its center. This electrode is run at a high or moderately high positive voltage, to accelerate the electrons towards the far end of the tube.

The *focussing electrode*, F, is a sleeve which usually contains two small disks, each with a small hole.

After leaving the focussing electrode, the electrons pass through another *accelerating*

anode, A, which is operated at a high positive potential. In some tubes this electrode is operated at a higher potential than the first accelerating electrode, H, while in other tubes both accelerating electrodes are operated at the same potential.

The electrodes which have been described up to this point constitute the *electron gun*, which produces the free electrons and focusses them into a slender, concentrated, rapidly-traveling stream for projecting onto the viewing screen.

Electrostatic Deflection To make the tube useful, means must be provided for deflecting the electron beam along two axes at right angles to each other. The more common tubes employ *electrostatic deflection plates*, one pair to exert a force on the beam in the vertical plane and one pair to exert a force in the horizontal plane. These plates are designated as B and C in figure 28.

Standard oscilloscope practice with small cathode-ray tubes calls for connecting one of the B plates and one of the C plates together and to the high voltage accelerating anode. With the newer three-inch tubes and with five-inch tubes and larger, all four deflecting plates are commonly used for deflection. The *positive* high voltage is grounded, instead of the negative as is common practice in amplifiers, etc., in order to permit operation of the deflecting plates at a d-c potential at or near ground.

An *Aquadag* coating is applied to the inside of the envelope to attract any secondary electrons emitted by the fluorescent screen.

In the average electrostatic-deflection CR tube the spot will be fairly well centered if all four deflection plates are returned to the potential of the second anode (ground). However, for accurate centering and to permit moving the entire trace either horizontally or vertically to permit display of a particular waveform, horizontal and vertical centering controls usually are provided on the front of the oscilloscope.

After the spot is once centered, it is necessary only to apply a positive or negative voltage (with respect to ground) to one of the ungrounded or "free" deflector plates in order to move the spot. If the voltage is positive with respect to ground, the beam will be attracted toward that deflector plate, while if negative the beam and spot will be repulsed. The amount of deflection is directly proportional to the voltage (with respect to ground) that is applied to the free electrode.

With the larger-screen higher-voltage tubes it becomes necessary to place deflecting voltage on both horizontal and both vertical plates. This is done for two reasons: First, the amount of deflection voltage required by the high-

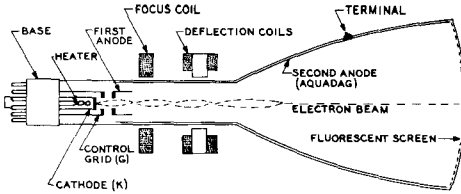

Figure 29
TYPICAL ELECTROMAGNETIC
CATHODE-RAY TUBE

voltage tubes is so great that a transmitting tube operating from a high voltage supply without distortion. By using push-pull deflection with two tubes feeding the deflection plates, the necessary plate supply voltage for the deflection amplifier is halved. Second, a certain amount of de-focussing of the electron stream is always present on the extreme excursions in deflection voltage when this voltage is applied only to one deflecting plate. When the deflecting voltage is fed in push-pull to both deflecting plates in each plane, there is no de-focussing because the *average* voltage acting on the electron stream is zero, even though the *net* voltage (which causes the deflection) acting on the stream is twice that on either plate.

The fact that the beam is deflected by a magnetic field is important even in an oscilloscope which employs a tube using electrostatic deflection, because it means that precautions must be taken to protect the tube from the transformer fields and sometimes even the earth's magnetic field. This normally is done by incorporating a magnetic shield around the tube and by placing any transformers as far from the tube as possible, oriented to the position which produces minimum effect upon the electron stream.

Construction of Electro- The electromagnetic cathode-ray tube allows greater definition than does the electrostatic tube. Also, electromagnetic definition has a number of advantages when a rotating radial sweep is required to give polar indications.

The production of the electron beam in an electromagnetic tube is essentially the same as in the electrostatic tube. The grid structure is similar, and controls the electron beam in an identical manner. The elements of a typical electromagnetic tube are shown in figure 29. The *focus coil* is wound on an iron core which may be moved along the neck of the tube to focus the electron beam. For final adjustment,

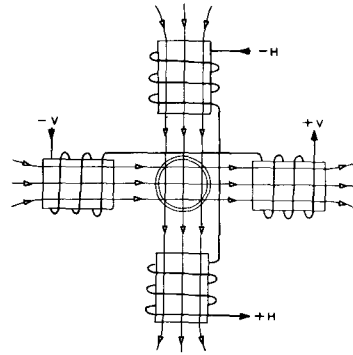

Figure 30
Two pairs of coils arranged for electro-
magnetic deflection in two directions.

the current flowing in the coil may be varied. A second pair of coils, the *deflection coils* are mounted at right angles to each other around the neck of the tube. In some cases, these coils can rotate around the axis of the tube.

Two *anodes* are used for accelerating the electrons from the cathode to the screen. The second anode is a graphite coating (Aquadag) on the inside of the glass envelope. The function of this coating is to attract any secondary electrons emitted by the fluorescent screen, and also to shield the electron beam.

In some types of electromagnetic tubes, a first, or *accelerating anode* is also used in addition to the Aquadag.

Electromagnetic Deflection A magnetic field will deflect an electron beam in a direction which is at right angles to both the direction of the field and the direction of motion of the beam.

In the general case, two pairs of deflection coils are used (figure 30). One pair is for horizontal deflection, and the other pair is for vertical deflection. The two coils in a pair are connected in series and are wound in such directions that the magnetic field flows from one coil, through the electron beam to the other coil. The force exerted on the beam by the field moves it to any point on the screen by application of the proper currents to these coils.

The Trace The human eye retains an image for about one-sixteenth second after viewing. In a CRT, the spot can be moved so quickly that a series of adjacent spots can be made to appear as a line, if the beam is swept over the path fast enough. As

long as the electron beam strikes in a given place at least sixteen times a second, the spot will appear to the human eye as a source of continuous light with very little flicker.

Screen Materials — "Phosphors" At least five types of luminescent screen materials are commonly available on the various types of CR tubes commercially available. These screen materials are called *phosphors*; each of the five phosphors is best suited to a particular type of application. The P-1 phosphor, which has a green fluorescence with medium persistence, is almost invariably used for oscilloscope tubes for visual observation. The P-4 phosphor, with white fluorescence and medium persistence, is used on television viewing tubes ("Kinescopes"). The P-5 and P-11 phosphors, with blue fluorescence and very short persistence, are used primarily in oscilloscopes where photographic recording of the trace is to be obtained. The P-7 phosphor, which has a blue flash and a long-persistence greenish-yellow persistence, is used primarily for radar displays where retention of the image for several seconds after the initial display is required.

4-9 Gas Tubes

The space charge of electrons in the vicinity of the cathode in a diode causes the plate-to-cathode voltage drop to be a function of the current being carried between the cathode and the plate. This voltage drop can be rather high when large currents are being passed, causing a considerable amount of energy loss which shows up as plate dissipation.

Action of Positive Ions The negative space charge can be neutralized by the presence of the proper density of positive ions in the space between the cathode and anode. The positive ions may be obtained by the introduction of the proper amount of gas or a small amount of mercury into the envelope of the tube. When the voltage drop across the tube reaches the ionization potential of the gas or mercury vapor, the gas molecules will become ionized to form positive ions. The positive ions then tend to neutralize the space charge in the vicinity of the cathode. The voltage drop across the tube then remains constant at the ionization potential of the gas up to a current drain equal to the maximum emission capability of the cathode. The voltage drop varies between 10 and 20 volts, depending upon the particular gas employed, up to the maximum current rating of the tube.

Mercury Vapor Tubes Mercury-vapor tubes, although very widely used, have the disadvantage that they must be operated within a specific temperature range (25° to 70° C.) in order that the mercury vapor pressure within the tube shall be within the proper range. If the temperature is too low, the drop across the tube becomes too high causing immediate overheating and possible damage to the elements. If the temperature is too high, the vapor pressure is too high, and the voltage at which the tube will "flash back" is lowered to the point where destruction of the tube may take place. Since the ambient temperature range specified above is within the normal room temperature range, no trouble will be encountered under normal operating conditions. However, by the substitution of xenon gas for mercury it is possible to produce a rectifier with characteristics comparable to those of the mercury-vapor tube except that the tube is capable of operating over the range from approximately -70° to 90° C. The 3B25 rectifier is an example of this type of tube.

Thyratron Tubes If a grid is inserted between the cathode and plate of a mercury-vapor gaseous-conduction rectifier, a negative potential placed upon the added element will increase the plate-to-cathode voltage drop required before the tube will ionize or "fire." The potential upon the control grid will have no effect on the plate-to-cathode drop after the tube has ionized. However, the grid voltage may be adjusted to such a value that conduction will take place only over the desired portion of the cycle of the a-c voltage being impressed upon the plate of the rectifier.

Voltage Regulator Tubes In a glow-discharge gas tube the voltage drop across the electrodes remains constant over a wide range of current passing through the tube. This property exists because the degree of ionization of the gas in the tube varies with the amount of current passing through the tube. When a large current is passed, the gas is highly ionized and the internal impedance of the tube is low. When a small current is passed, the gas is lightly ionized and the internal impedance of the tube is high. Over the operating range of the tube, the product (IR) of the current through the tube and the internal impedance of the tube is very nearly constant. Examples of this type of tube are VR-150, VR-105 and the old 874.

Vacuum Tube Classification Vacuum tubes are grouped into three major classifications: commercial, ruggedized, and premium (or reliable). Any one of these three groups may also be further classified for

military duty (JAN classification). To qualify for JAN classification, sample lots of the particular tube must have passed special qualification tests at the factory. It should not be construed that a JAN-type tube is better than a commercial tube, since some commercial tests and specifications are more rigid than the corresponding JAN specifications. The JAN-stamped tube has merely been accepted under a certain set of conditions for military service.

Ruggedized or Premium Tubes Radio tubes are being used in increasing numbers for industrial applications, such as computing and control machinery, and in aviation and marine equipment. When a tube fails in a home radio receiver, it is merely inconvenient, but a tube failure in industrial applications may bring about stoppage of some vital process, resulting in financial loss, or even danger to life.

To meet the demands of these industrial applications, a series of tubes was evolved incorporating many special features designed to ensure a long and pre-determined operating life, and uniform characteristics among similar tubes. Such tubes are known as *ruggedized* or *premium* tubes. Early attempts to select re-

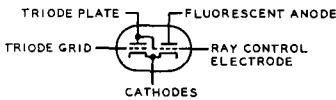

Figure 31
SCHEMATIC REPRESENTATION
OF "MAGIC EYE" TUBE

liable specimens of tubes from ordinary stock tubes proved that in the long run the selected tubes were no better than tubes picked at random. Long life and ruggedness had to be built into the tubes by means of proper choice and 100% inspection of all materials used in the tube, by critical processing inspection and assembling, and by conservative ratings of the tube.

Pure tungsten wire is used for heaters in preference to alloys of lower tensile strength. Nickel tubing is employed around the heater wires at the junction to the stem wires to reduce breakage at this point. Element structures are given extra supports and bracing. Finally, all tubes are given a 50 hour test run under full operating conditions to eliminate early failures. When operated within their ratings, ruggedized or premium tubes should provide a life well in excess of 10,000 hours.

Ruggedized tubes will withstand severe impact shocks for short periods, and will

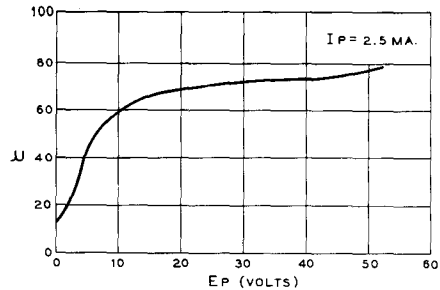

Figure 32
AMPLIFICATION FACTOR OF TYPICAL MODE
TUBE DROPS RAPIDLY AS PLATE VOLTAGE
IS DECREASED BELOW 20 VOLTS

operate under conditions of vibration for many hours. The tubes may be identified in many cases by the fact that their nomenclature includes a "W" in the type number, as in 807W, 5U4W, etc. Some ruggedized tubes are included in the "5000" series nomenclature. The 5654 is a ruggedized version of the 6AK5, the 5692 is a ruggedized version of the 6SN7, etc.

4-10 Miscellaneous Tube Types

Electron Ray Tubes The electron-ray tube or *magic eye* contains two sets of elements, one of which is a triode amplifier and the other a cathode-ray indicator. The plate of the triode section is internally connected to the ray-control electrode (figure 31), so that as the plate voltage varies in accordance with the applied signal the voltage on the ray-control electrode also varies. The ray-control electrode is a metal cylinder so placed relative to the cathode that it deflects some of the electrons emitted from the cathode. The electrons which strike the anode cause it to fluoresce, or give off light, so that the deflection caused by the ray-control electrode, which prevents electrons from striking part of the anode, produces a wedge-shaped electrical shadow on the fluorescent anode. The size of this shadow is determined by the voltage on the ray-electrode. When this electrode is at the same potential as the fluorescent anode, the shadow disappears; if the ray-electrode is less positive than the anode, a shadow appears the width of which is proportional to the voltage on the ray-electrode. Magic eye tubes may be used as tuning indicators, and as balance indicators in electrical bridge circuits. If the angle of shadow is calibrated, the eye tube may be used as a voltmeter where rough measurements suffice.

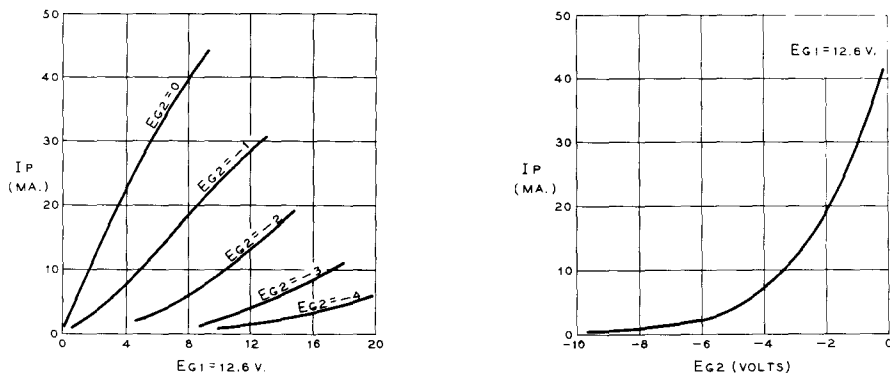

Figure 33
CHARACTERISTIC CURVES OF 12AK5
SPACE-CHARGE TRIODE

Controlled Warm-up Tubes Series heater strings are employed in ac-dc radio receivers and television sets to reduce the cost, size, and weight of the equipment.

Voltage surges of great magnitude occur in series operated filaments because of variations in the rate of warm-up of the various tubes. As the tubes warm up, the heater resistance changes. This change is not the same between tubes of various types, or even between tubes of the same type made by different manufacturers. Some 6-volt tubes show an initial surge as high as 9-volts during warm-up, while slow-heating tubes such as the 25BQ6 are underheated during the voltage surge on the 6-volt tubes.

Standardization of heater characteristics in a new group of tubes designed for series heater strings has eliminated this trouble. The new tubes have either 600 ma. or 400 ma. heaters, with a controlled warm-up time of approximately 11 seconds. The 5U8, 6CG7, and 12BH7-A are examples of controlled warm-up tubes.

Low Plate Potential Tubes Introduction of the 12-volt ignition system in American automobiles has brought about the design of a series of tubes capable of operation with a plate potential of 12-14 volts. Standard tubes perform poorly at low plate potentials, as the amplification factor of the tube drops rapidly as the plate voltage is decreased (figure 32). Contact potential effects, and change of characteristics with variations of filament voltage combine to make operation at low plate potentials even more erratic.

By employing special processing techniques

and by altering the electrode geometry a series of low voltage tubes has been developed by *Tung-Sol* that effectively perform with all electrodes energized by a 12-volt system. With a suitable power output transistor, this makes possible an automobile radio without a vibrator power supply. A special space-charge tube (12K5) has been developed that delivers 40 milliwatts of audio power with a 12 volt plate supply (figure 33).

Foreign Tubes The increased number of imported radios and high-fidelity equipment have brought many foreign vacuum tubes into the United States. Many of these tubes are comparable to, or interchangeable with standard American tubes. A complete listing of the electrical characteristics and base connection diagrams of all general-purpose tubes made in all tube-producing countries outside the "Iron Curtain" is contained in the *Radio Tube Vade Mecum (World's Radio Tubes)* available at most larger radio parts jobbers for \$5.00, or by mail from the publishers of this *Handbook* at \$5.50 postpaid. The *Equivalent Tubes Vade Mecum (World's Equivalent Tubes)* available at the same prices gives all replacement tubes for a given type, both exact and near-equivalents (with points of difference detailed). (Data on TV and special-purpose tubes if needed is contained in a companion volume *Television Tubes Vade Mecum*).

Transistors and Semi-Conductors

One of the earliest detection devices used in radio was the galena crystal, a crude example of a *semiconductor*. More modern examples of semiconductors are the copper-oxide rectifier, the selenium rectifier and the germanium diode. All of these devices offer the interesting property of greater resistance to the flow of electrical current in one direction than in the opposite direction. Typical conduction curves for these semiconductors are shown in Figure 1. The copper oxide rectifier action results from the function of a thin film of cuprous oxide formed upon a pure copper disc. This film offers low resistance for positive voltages, and high resistance for negative voltages. The same action is observed in selenium rectifiers, where a film of selenium is deposited on an iron surface.

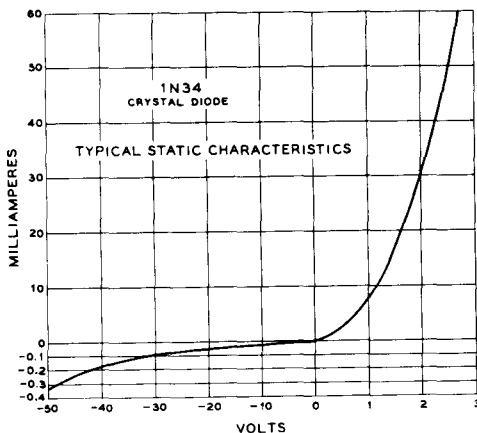

Figure 1A
TYPICAL CHARACTERISTIC CURVE
OF SEMI-CONDUCTOR DIODE

5-1 Atomic Structure of Germanium and Silicon

It has been previously stated that the electrons in an element having a large atomic number are grouped into rings, each ring having a definite number of electrons. Atoms in which these rings are completely filled are called *inert gases*, of which helium and argon are examples. All other elements have one or more incomplete rings of electrons. If the incomplete ring is loosely bound, the element may be easily removed, the element is called *metallic*, and is a conductor of electric current. If the incomplete ring is tightly bound, with only a few missing electrons, the element is called *non-metallic* and is an insulator of electric current. Germanium and silicon fall between these two sharply defined groups, and exhibit both metallic and non-metallic characteristics. Pure germanium or silicon may be considered to be a good insulator. The addition of certain impurities in carefully controlled amounts to the pure germanium will alter the conductivity of the material. In addition, the choice of the impurity can change the direction of conductivity through the crystal, some impurities increasing conductivity to positive voltages, and others increasing conductivity to negative voltages.

5-2 Mechanism of Conduction

As indicated by their name, semiconductors are substances which have a conductivity intermediate between the high values observed for metals and the low values observed for insulating materials. The mechanism of conduction in semiconductors is different from that

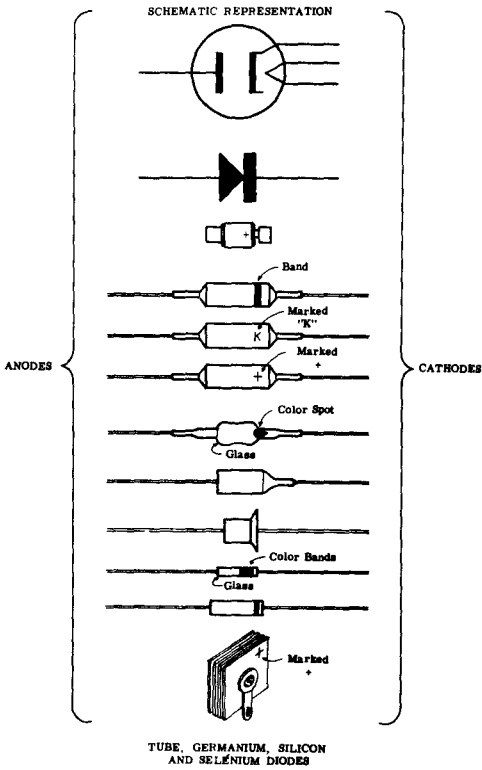

**Figure 1-B
COMMON DIODE COLOR CODES
AND MARKINGS ARE SHOWN
IN ABOVE CHART**

observed in metallic conductors. There exist in semiconductors both negatively charged electrons and positively charged particles, called *holes*, which behave as though they had a positive electrical charge equal in magnitude to the negative electrical charge on the electron. These holes and electrons drift in an electrical field with a velocity which is proportional to the field itself:

$$V_{dh} = \mu_h E$$

where V_{dh} = drift velocity of hole
 E = magnitude of electric field
 μ_h = mobility of hole

In an electric field the holes will drift in a direction opposite to that of the electron and with about one-half the velocity, since the hole mobility is about one-half the electron mobility. A sample of a semiconductor, such as germanium or silicon, which is both chemically pure and mechanically perfect will contain in it approximately equal numbers of holes and electrons and is called an *intrinsic* semiconductor. The intrinsic resistivity of the semiconductor depends strongly upon the temperature, being about 50 ohm/cm. for germanium at room temperature. The intrinsic resistivity of silicon is about 65,000 ohm/cm. at the same temperature.

If, in the growing of the semiconductor crystal, a small amount of an impurity, such as phosphorous, arsenic or antimony is included in the crystal, each atom of the impurity contributes one free electron. This electron is available for conduction. The crystal is said to be *doped* and has become electron-conduct-

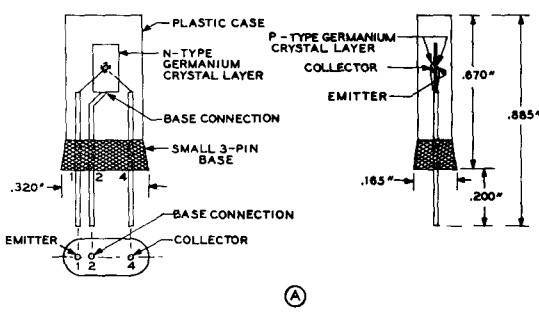

**Figure 2A
CUT-AWAY VIEW OF JUNCTION
TRANSISTOR, SHOWING PHYSICAL
ARRANGEMENT**

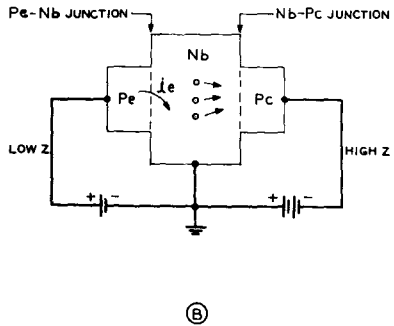

**Figure 2B
PICTORIAL EQUIVALENT OF
P-N-P JUNCTION TRANSISTOR**

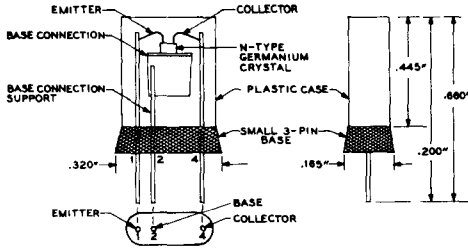

Figure 3
CONSTRUCTION DETAIL OF A
POINT CONTACT TRANSISTOR

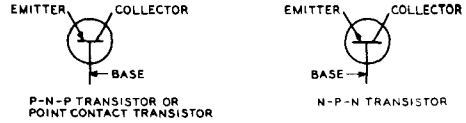

Figure 4
ELECTRICAL SYMBOLS
FOR TRANSISTORS

ing in nature and is called *N* (*negative*) type germanium. The impurities which contribute electrons are called *donors*. N-type germanium has better conductivity than pure germanium in one direction, and a continuous stream of electrons will flow through the crystal in this direction as long as an external potential of the correct polarity is applied across the crystal.

Other impurities, such as aluminum, gallium or indium add one hole to the semiconducting crystal by accepting one electron for each atom of impurity, thus creating additional holes in the semiconducting crystal. The material is now said to be hole-conducting, or *P* (*positive*) type germanium. The impurities which create holes are called *acceptors*. P-type germanium has better conductivity than pure germanium in one direction. This direction is opposite to that of the N-type material. Either the N-type or the P-type germanium is called *extrinsic* conducting type. The doped materials have lower resistivities than the pure materials, and doped semiconductors in the resistivity range of .01 to 10 ohm/cm. are normally used in the production of transistors.

5-3 The Transistor

In the past few years an entire new technology has been developed for the application of certain semiconducting materials in production of devices having gain properties. These gain properties were previously found only in vacuum tubes. The elements germanium and silicon are the principal materials which exhibit the proper semiconducting properties permitting their application in the new amplifying devices called *transistors*. However, other semiconducting materials, including the compounds indium antimonide and lead sulfide have been used experimentally in the production of transistors.

Types of Transistors There are two basic types of transistors, the *point-contact* type and the *junction* type (figure 2). Typical construction detail of a point-contact transistor is shown in Figure 3, and the electrical symbol is shown in Figure 4. The *emitter* and *collector* electrodes make contact with a small block of germanium, called the *base*. The base may be either N-type or P-type germanium, and is approximately .05" long and .03" thick. The emitter and collector electrodes are fine wires, and are spaced about .005" apart on the germanium base. The complete assembly is usually encapsulated in a small, plastic case to provide ruggedness and to avoid contaminating effects of the atmosphere. The polarity of emitter and collector voltages depends upon the type of germanium employed in the base, as illustrated in figure 4.

The junction transistor consists of a piece of either N-type or P-type germanium between two wafers of germanium of the opposite type. Either N-P-N or P-N-P transistors may be made. In one construction called the *grown crystal process*, the original crystal, grown from molten germanium or silicon, is created in such a way as to have the two closely spaced junctions imbedded in it. In the other construction called the *fusion process*, the crystals are grown so as to make them a single conductivity type. The junctions are then produced by fusing small pellets of special metal alloys into minute plates cut from the original crystal. Typical construction detail of a junction transistor is shown in figure 2A.

The electrical schematic for the P-N-P junction transistor is the same as for the point-contact type, as is shown in figure 4.

Transistor Action Presently available types of transistors have three essential actions which collectively are called *transistor action*. These are: minority carrier injection, transport, and collection. Figure 2B shows a simplified drawing of a P-N-P junction-type transistor, which can illustrate this

collective action. The P-N-P transistor consists of a piece of N-type germanium on opposite sides of which a layer of P-type material has been grown by the fusion process. Terminals are connected to the two P-sections and to the N-type base. The transistor may be considered as two P-N junction rectifiers placed in close juxtaposition with a semiconductor crystal coupling the two rectifiers together. The left-hand terminal is biased in the forward (or conducting) direction and is called the emitter. The right-hand terminal is biased in the back (or reverse) direction and is called the collector. The operating potentials are chosen with respect to the base terminal, which may or may not be grounded. If an N-P-N transistor is used in place of the P-N-P, the operating potentials are reversed.

The $P_e - N_b$ junction on the left is biased in the forward direction and holes from the P region are injected into the N_b region, producing therein a concentration of holes substantially greater than normally present in the material. These holes travel across the base region towards the collector, attracting neighboring electrons, finally increasing the available supply of conducting electrons in the collector loop. As a result, the collector loop possesses lower resistance whenever the emitter circuit is in operation. In junction transistors this *charge transport* is by means of diffusion wherein the charges move from a region of high concentration to a region of lower concentration at the collector. The collector, biased in the opposite direction, acts as a *sink* for these holes, and is said to collect them.

It is known that any rectifier biased in the forward direction has a very low internal impedance, whereas one biased in the back direction has a very high internal impedance. Thus, current flows into the transistor in a low impedance circuit, and appears at the output as current flowing in a high impedance circuit. The ratio of a change in collector current to a change in emitter current is called the *current amplification*, or *alpha*:

$$a = \frac{i_c}{i_e}$$

where a = current amplification

i_c = change in collector current

i_e = change in emitter current

Values of alpha up to 3 or so may be obtained in commercially available point-contact transistors, and values of alpha up to about 0.95 are obtainable in junction transistors.

Alpha Cutoff Frequency The *alpha cutoff frequency* of a transistor is that frequency at which the grounded base current gain has decreased to 0.7 of the gain obtained at 1 kc. For audio transistors, the alpha cutoff frequency is in the region of 0.7 Mc. to 1.5 Mc. For r-f and switching transistors, the alpha cutoff frequency may be 5 Mc. or higher. The upper frequency limit of operation of the transistor is determined by the small but finite time it takes the *majority carrier* to move from one electrode to another.

Drift Transistors As previously noted, the signal current in a conventional transistor is transmitted across the base region by a diffusion process. The transit time of the carriers across this region is, therefore relatively long. RCA has developed a technique for the manufacture of transistors which does not depend upon diffusion for transmission of the signal across the base region. Transistors featuring this new process are known as *drift transistors*. Diffusion of charge carriers across the base region is eliminated and the carriers are propelled across the region by a "built in" electric field. The resulting reduction of transit time of the carrier permits drift transistors to be used at much higher frequencies than transistors of conventional design.

The "built in" electric field is in the base region of the drift transistor. This field is achieved by utilizing an impurity density which varies from one side of the base to the other. The impurity density is high next to the emitter and low next to the collector. Thus, there are more mobile electrons in the region near the emitter than in the region near the collector, and they will try to diffuse evenly throughout the base. However, any displacement of the negative charge leaves a positive charge in the region from which the electrons came, because every atom of the base material was originally electrically neutral. The displacement of the charge creates an electric field that tends to prevent further electron diffusion so that a condition of equilibrium is reached. The direction of this field is such as to prevent electron diffusion from the high density area near the emitter to the low density area near the collector. Therefore, holes entering the base will be accelerated from the emitter to the collector by the electric field. Thus the diffusion of charge carriers across the base region is augmented by the built-in electric field. A potential energy diagram for a drift transistor is shown in figure 5.

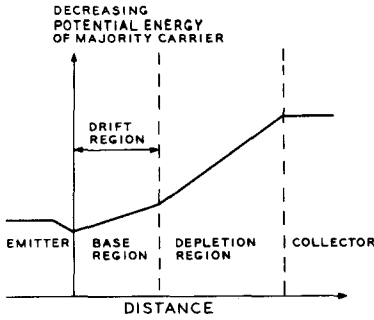

Figure 5
POTENTIAL ENERGY DIAGRAM
FOR DRIFT TRANSISTOR (2N247)

5-4 Transistor Characteristics

The transistor produces results that may be comparable to a vacuum tube, but there is a basic difference between the two devices. The vacuum tube is a voltage controlled device whereas the transistor is a current controlled device. A vacuum tube normally operates with its grid biased in the negative or high resistance direction, and its plate biased in the positive or low resistance direction. The tube conducts only by means of electrons, and has its conducting counterpart in the form of the N-P-N transistor, whose majority carriers are also electrons. There is no vacuum tube equivalent of the P-N-P transistor, whose majority carriers are holes.

The biasing conditions stated above provide the high input impedance and low output impedance of the vacuum tube. The transistor is biased in the positive or low resistance direction in the emitter circuit, and in the negative, or high resistance direction in the collector circuit resulting in a low input impedance and a high output impedance, contrary to and opposite from the vacuum tube. A comparison of point-contact transistor characteristics and vacuum tube characteristics is made in figure 6.

The *resistance gain* of a transistor is expressed as the ratio of output resistance to input resistance. The input resistance of a typical transistor is low, in the neighborhood of 300 ohms, while the output resistance is relatively high, usually over 20,000 ohms. For a point-contact transistor, the resistance gain is usually over 60.

The *voltage gain* of a transistor is the product of alpha times the resistance gain, and for a point-contact transistor is of the

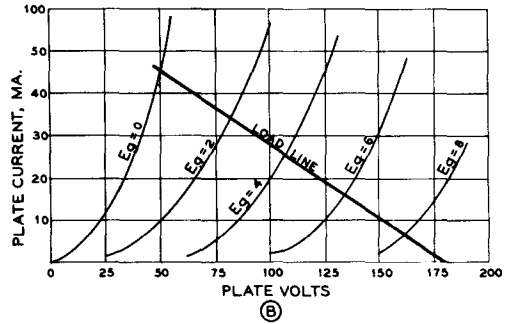
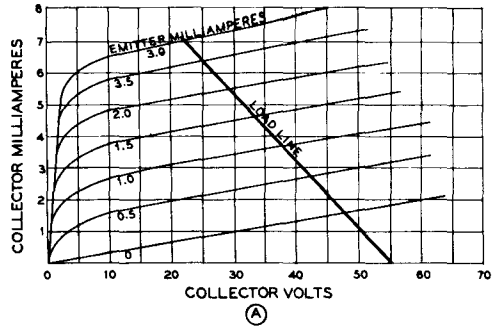

Figure 6
COMPARISON OF POINT-CONTACT
TRANSISTOR AND VACUUM TUBE
CHARACTERISTICS

order of $3 \times 60 = 180$. A junction transistor which has a value of alpha less than unity nevertheless has a resistance gain of the order of 2000 because of its extremely high output resistance, and the resulting voltage gain is about 1800 or so. For both types of transistors the *power gain* is the product of alpha squared times the resistance gain and is of the order of 400 to 500.

The output characteristics of the junction transistor are of great interest. A typical example is shown in figure 7. It is seen that the junction transistor has the characteristics of an ideal pentode vacuum tube. The collector current is practically independent of the collector voltage. The range of linear operation extends from a minimum voltage of about 0.2 volts up to the maximum rated collector voltage. A typical load line is shown, which illustrates the very high load impedance that would be required for maximum power transfer. A grounded emitter circuit is usually used, since the output impedance is not as high as when a grounded base circuit is used.

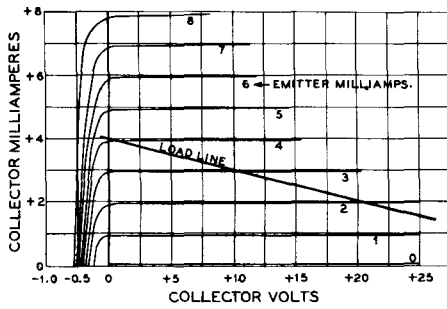
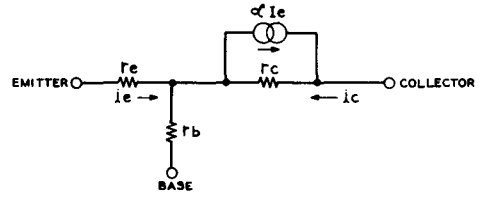

Figure 7
OUTPUT CHARACTERISTICS OF
TYPICAL JUNCTION TRANSISTOR

The output characteristics of a typical point-contact transistor are shown in figure 6. The pentode characteristics are less evident, and the output impedance is much lower, with the range of linear operation extending down to a collector voltage of 2 or 3. Of greater practical interest, however, is the input characteristic curve with short-circuited, or nearly short-circuited input, as shown in figure 8. It is this point-contact transistor characteristic of having a region of negative impedance that lends the unit to use in switching circuits. The transistor circuit may be made to have two, one or zero stable operating points, depending upon the bias voltages and the load impedance used.

Equivalent Circuit of a Transistor As is known from network theory, the small signal performance of any device in any network can be represented by means of an equivalent circuit. The most



VALUES OF THE EQUIVALENT CIRCUIT

PARAMETER	POINT-CONTACT TRANSISTOR ($I_e = 1 \text{ MA.}, V_C = 15 \text{ V.}$)	JUNCTION TRANSISTOR ($I_e = 1 \text{ MA.}, V_C = 3 \text{ V.}$)
r_e - EMITTER RESISTANCE	100 Ω	30 Ω
r_b - BASE RESISTANCE	300 Ω	300 Ω
r_c - COLLECTOR RESISTANCE	20000 Ω	1 MEGOHM
α - CURRENT AMPLIFICATION	2.0	0.97

Figure 9
LOW FREQUENCY EQUIVALENT
(Common Base) CIRCUIT FOR POINT
CONTACT AND JUNCTION
TRANSISTOR

convenient equivalent circuit for the low frequency small signal performance of both point-contact and junction transistors is shown in figure 9. r_e , r_b , and r_c , are dynamic resistances which can be associated with the emitter, base and collector regions of the transistor. The current generator αI_e , represents the transport of charge from emitter to collector. Typical values of the equivalent circuit are shown in figure 9.

Transistor Configurations There are three basic transistor configurations: grounded base connection, grounded emitter connection, and grounded collector connection. These correspond roughly to grounded grid, grounded cathode, and grounded plate circuits in vacuum tube terminology (figure 10).

The grounded base circuit has a low input impedance and high output impedance, and no phase reversal of signal from input to output circuit. The grounded emitter circuit has a higher input impedance and a lower output impedance than the grounded base circuit, and a reversal of phase between the input and output signal occurs. This circuit usually provides maximum voltage gain from a transistor. The grounded collector circuit has relatively high input impedance, low output impedance, and no phase reversal of signal from input to output circuit. Power and voltage gain are both low.

Figure 11 illustrates some practical vacuum tube circuits, as applied to transistors.

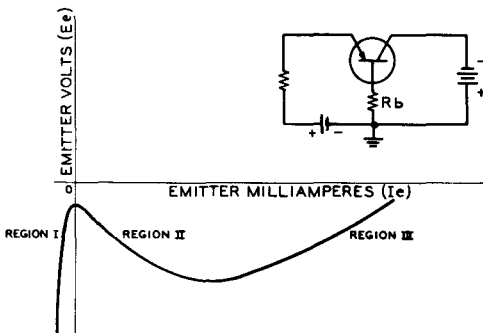

Figure 8
EMITTER CHARACTERISTIC CURVE
FOR TYPICAL POINT CONTACT
TRANSISTOR

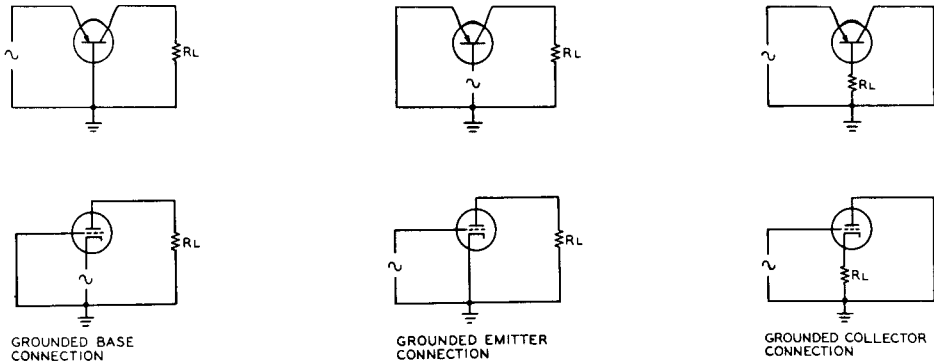

Figure 10
COMPARISON OF BASIC VACUUM TUBE AND TRANSISTOR CONFIGURATIONS

5-5 Transistor Circuitry

To establish the correct operating parameters of the transistor, a bias voltage must be established between the emitter and the base. Since transistors are temperature sensitive devices, and since some variation in characteristics usually exists between transistors of a given type, attention must be given to the bias system to

overcome these difficulties. The simple *self-bias* system is shown in figure 12A. The base is simply connected to the power supply through a large resistance which supplies a fixed value of base current to the transistor. This bias system is extremely sensitive to the current transfer ratio of the transistor, and must be adjusted for optimum results with each transistor.

When the supply voltage is fairly high and

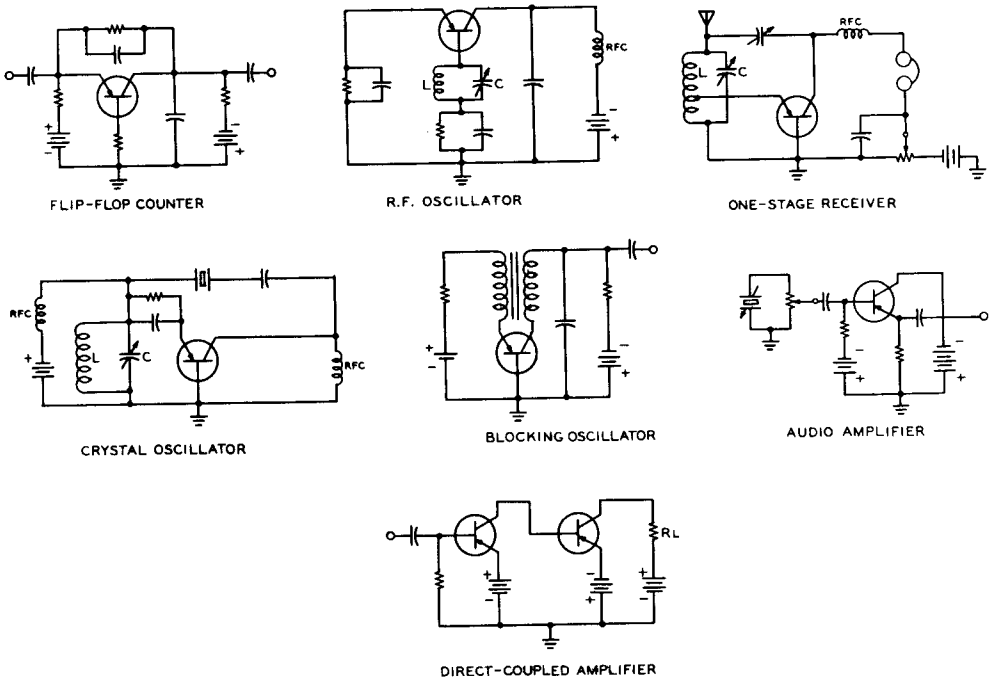

Figure 11
TYPICAL TRANSISTOR CIRCUITS

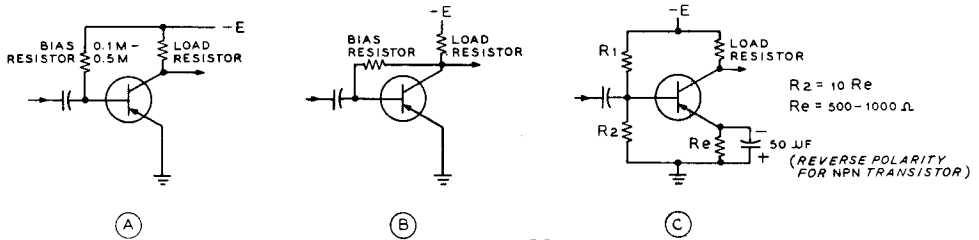

Figure 12
BIAS CONFIGURATIONS FOR TRANSISTORS.
 The voltage divider system of C is recommended for general transistor use. Ratio of R_1/R_2 establishes base bias, and emitter bias is provided by voltage drop across R_e . Battery Polarity is reversed for N-P-N transistors.

wide variations in ambient temperature do not occur, the bias system of figure 12B may be used, with the bias resistor connected from base to collector. When the collector voltage is high, the base current is increased, moving the operating point of the transistor down the load line. If the collector voltage is low, the operating point moves upwards along the load line, thus providing automatic control of the base bias voltage. This circuit is sensitive to changes in ambient temperature, and may permit transistor failure when the transistor is operated near maximum dissipation ratings.

A better bias system is shown in figure 12C, where the base bias is obtained from a voltage divider, (R_1, R_2), and the emitter is forward biased. To prevent signal degeneration, the emitter bias resistor is bypassed with a large capacitance. A high degree of circuit stability is provided by this form of bias, providing the emitter capacitance is of the order of 50 μ fd. for audio frequency applications.

Audio Circuitry A simple voltage amplifier is shown in figure 13. Direct current stabilization is employed in the emitter circuit. Operating parameters for the

amplifier are given in the drawing. In this case, the input impedance of the amplifier is quite low. When used with a high impedance driving source such as a crystal microphone a step down input transformer should be employed as shown in figure 13B. The grounded collector circuit of figure 13C provides a high input impedance and a low output impedance, much as in the manner of a vacuum tube cathode follower.

The circuit of a two stage resistance coupled amplifier is shown in figure 14A. The input impedance is approximately 1100 ohms. Feedback may be placed around this amplifier from the emitter of the second stage to the base of the first stage, as shown in figure 14B. A direct coupled version of the r-c amplifier is shown in figure 14C. The input impedance is of the order of 15,000 ohms, and an overall voltage gain of 80 may be obtained with a supply potential of 12 volts.

It is possible to employ N-P-N and P-N-P transistors in *complementary symmetry* circuits which have no equivalent in vacuum tube design. Figure 15A illustrates such a circuit. A symmetrical push-pull circuit is shown in

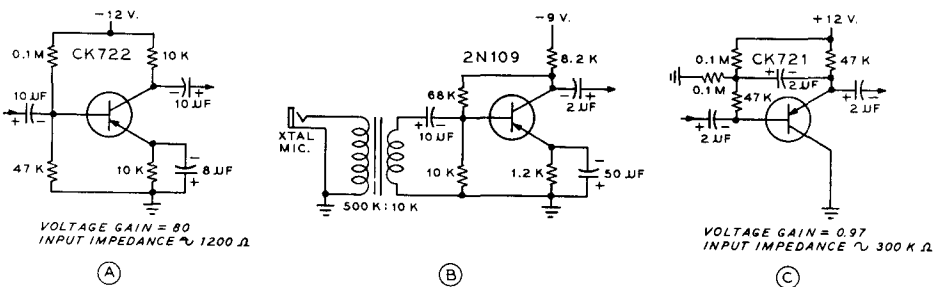

Figure 13
P-N-P TRANSISTOR VOLTAGE AMPLIFIERS
 A resistance coupled amplifier employing an inexpensive CK-722 transistor is shown in A. For use with a high impedance crystal microphone, a step-down transformer matches the low input impedance of the transistor, as shown in B. The grounded collector configuration of C provides an input impedance of about 300,000 ohms.

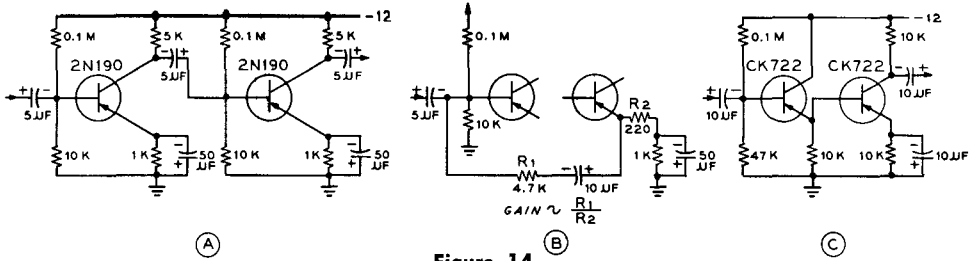

Figure 14
TWO STAGE TRANSISTOR AUDIO AMPLIFIERS

The feedback loop of B may be added to the r-c amplifier to reduce distortion, or to control the audio response. A direct coupled amplifier is shown in C.

figure 15B. This circuit may be used to directly drive a high impedance loudspeaker, eliminating the output transformer. A direct coupled three stage amplifier having a gain figure of 80 db is shown in figure 15C.

The transistor may also be used as a class A power amplifier, as shown in figure 16A. Commercial transistors are available that will provide five or six watts of audio power when operating from a 12 volt supply. The smaller units provide power levels of a few milliwatts. The correct operating point is chosen so that the output signal can swing equally in the positive and negative directions, as shown in the collector curves of figure 16B.

The proper primary impedance of the output transformer depends upon the amount of power to be delivered to the load:

$$R_p = \frac{E_c^2}{2P_o}$$

The collector current bias is:

$$I_{c-} = \frac{2P_o}{E_c}$$

In a class A output stage, the maximum a-c

power output obtainable is limited to 0.5 the allowable dissipation of the transistor. The product $I_c E_c$ determines the maximum collector dissipation, and a plot of these values is shown in figure 16B. The load line should always lie under the dissipation curve, and should encompass the maximum possible area between the axes of the graph for maximum output condition. In general, the load line is tangent to the dissipation curve and passes through the supply voltage point at zero collector current. The d-c operating point is thus approximately one-half the supply voltage.

The circuit of a typical push-pull class B transistor amplifier is shown in figure 17A. Push-pull operation is desirable for transistor operation, since the even-order harmonics are largely eliminated. This permits transistors to be driven into high collector current regions without distortion normally caused by non-linearity of the collector. Cross-over distortion is reduced to a minimum by providing a slight forward base bias in addition to the normal emitter bias. The base bias is usually less than 0.5 volt in most cases. Excessive base bias will boost the quiescent collector current and thereby lower the overall efficiency of the stage.

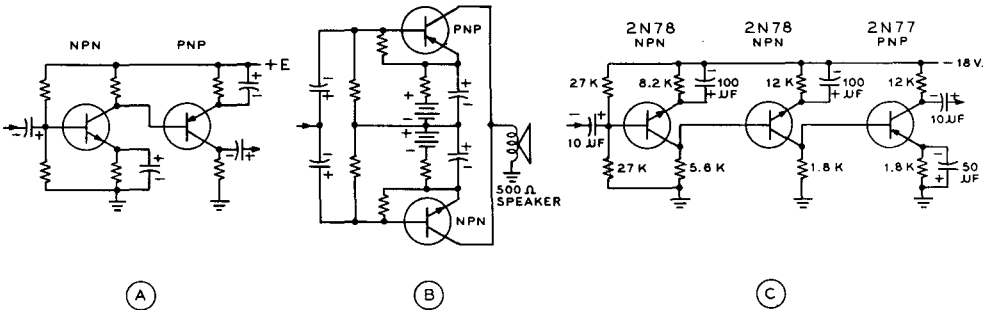
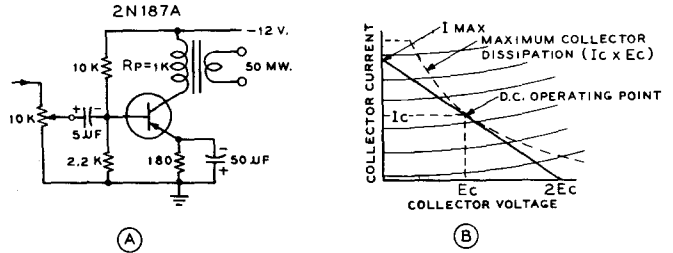

Figure 15
COMPLEMENTARY SYMMETRY AMPLIFIERS.

N-P-N and P-N-P transistors may be combined in circuits which have no equivalent in vacuum tube design. Direct coupling between cascaded stages using a single power supply source may be employed, as in C. Impedance of power supply should be extremely low.

Figure 16
TYPICAL CLASS-A
AUDIO POWER
TRANSISTOR CIRCUIT.
The correct operating point is chosen so that output signal can swing equally in a positive or negative direction, without exceeding maximum collector dissipation.



The operating point of the class B amplifier is set on the $I_c=0$ axis at the point where the collector voltage equals the supply voltage. The collector to collector impedance of the output transformer is:

$$R_{c-c} = \frac{2E_c^2}{P_o}$$

In the class B circuit, the maximum a-c power input is approximately equal to five times the allowable collector dissipation of each transistor. Power transistors, such as the 2N301 have collector dissipation ratings of 5.5 watts and operate with class B efficiency of about 67%. To achieve this level of operation the heavy duty transistor relies upon efficient heat transfer from the transistor case to the chassis, using the large thermal capacity of the chassis as a *heat sink*. An infinite heat sink may be approximated by mounting the transistor in the center of a 6" x 6" copper or aluminum sheet. This area may be part of a larger chassis.

The collector of most power transistors is electrically connected to the case. For applications where the collector is not grounded a thin sheet of mica may be used between the case of the transistor and the chassis.

Power transistors such as the *Philco T-1041* may be used in the common collector class B

configuration (figure 17C) to obtain high power output at very low distortions comparable with those found in quality vacuum tube circuits having heavy overall feedback. In addition, the transistor may be directly bolted to the chassis, assuming a negative grounded power supply. Power output is of the order of 10 watts, with about 0.5% total distortion.

R-F Circuitry Transistors may be used for radio frequency work provided the alpha cutoff frequency of the units is sufficiently higher than the operating frequency. Shown in figure 18A is a typical i-f amplifier employing an N-P-N transistor. The collector current is determined by a voltage divider on the base circuit and by a bias resistor in the emitter leg. Input and output are coupled by means of tuned i-f transformers. Bypass capacitors are placed across the bias resistors to prevent signal frequency degeneration. The base is connected to a low impedance untuned winding of the input transformer, and the collector is connected to a tap on the output transformer to provide proper matching, and also to make the performance of the stage relatively independent of variations between transistors of the same type. With a rate-grown N-P-N transistor such as the G.E. 2N293, it is unnecessary to use neutralization to obtain circuit stability. When P-N-P alloy

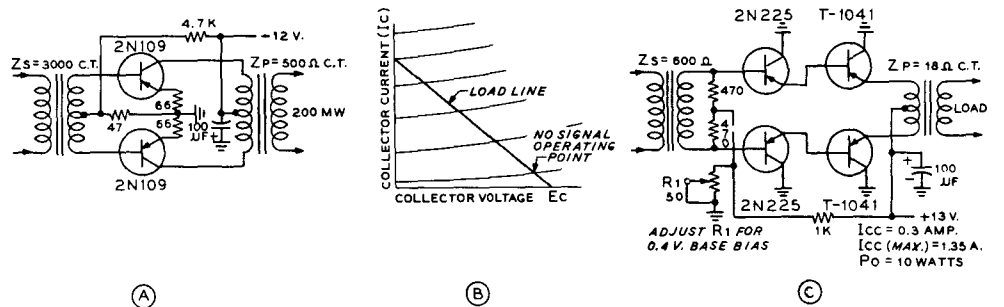

Figure 17
CLASS-B AUDIO AMPLIFIER CIRCUITRY.
The common collector circuit of C permits the transistor to be bolted directly to the chassis for efficient heat transfer from the transistor case to the chassis.

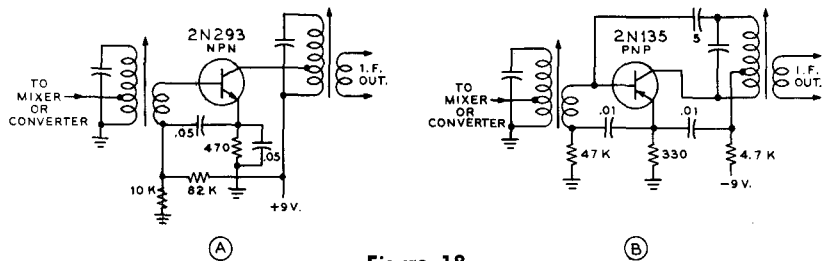

Figure 18
TRANSISTORIZED I-F AMPLIFIERS.

Typical P-N-P transistor must be neutralized because of high collector capacitance. Rate grown N-P-N transistor does not usually require external neutralizing circuit.

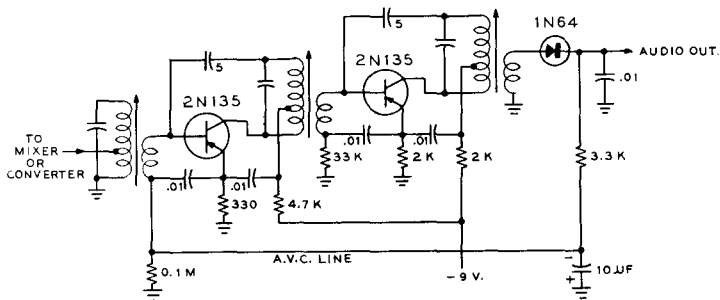

Figure 19
AUTOMATIC VOLUME CONTROL CIRCUIT FOR TRANSISTORIZED I-F AMPLIFIER.

transistors are used, it is necessary to neutralize the circuit to obtain stability (figure 18B).

The gain of a transistor i-f amplifier will decrease as the emitter current is decreased. This transistor property can be used to control the gain of an i-f amplifier so that weak and strong signals will produce the same audio output. A typical i-f strip incorporating this automatic volume control action is shown in figure 19.

R-f transistors may be used as mixers or autodyne converters much in the same manner as vacuum tubes. The autodyne circuit is shown in figure 20. Transformer T₁ feeds back a

signal from the collector to the emitter causing oscillation. Capacitor C₁ tunes the oscillator circuit to a frequency 455 kc. higher than that of the incoming signal. The local oscillator signal is inductively coupled into the emitter circuit of the transistor. The incoming signal is resonated in T₂ and coupled via a low impedance winding to the base circuit. Notice that the base is biased by a voltage divider circuit much the same as is used in audio frequency operation. The two signals are mixed in this stage and the desired beat frequency of 455 kc. is selected by i-f transformer T₃ and passed to the next stage. Collector currents of 0.6 ma. to 0.8 ma. are common, and the local oscillator injection voltage at the emitter is in the range of 0.15 to 0.25 volts, r.m.s.

A complete receiver "front end" capable of operation up to 23 Mc. is shown in figure 21. The RCA 2N247 drift transistor is used for the r-f amplifier (TR1), mixer (TR2), and high frequency oscillator (TR3). The 2N247 incorporates an interlead shield, cutting the interlead capacitance to .003 μμfd. If proper shielding is employed between the tuned circuits of the r-f stage, no neutralization of the stage is required. The complete assembly obtains power from a 9-volt transistor battery. Note that input and output circuits of the transistors are tapped at low impedance points on the r-f coils to achieve proper impedance match.

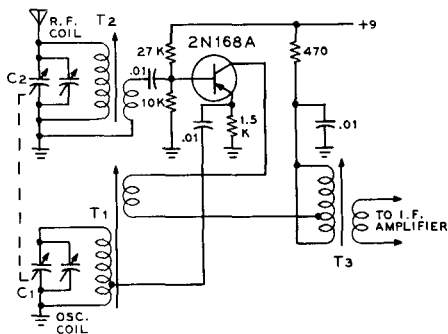
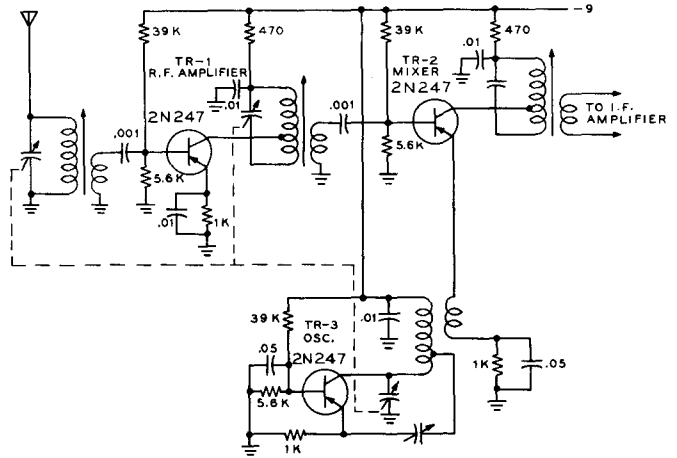

Figure 20
THE AUTODYNE CONVERTER CIRCUIT USING A 2N168A AS A MIXER.

Figure 21
RF AMPLIFIER, MIXER,
AND OSCILLATOR
STAGES FOR
TRANSISTORIZED
HIGH FREQUENCY
RECEIVER. THE RCA
2N247 DRIFT
TRANSISTOR IS
CAPABLE OF
EFFICIENT OPERATION
UP TO 23 Mc.



Transistor Oscillators Sufficient coupling of the proper phase between input and output circuits of the transistor will permit oscillation up to and slightly above the alpha cutoff frequency. Various forms of transistor oscillators are shown in figure 22. A simple grounded emitter Hartley oscillator having positive feedback between the base and the collector (22A) is compared to a grounded base Hartley oscillator (22B). In each case the resonant tank circuit is common to the input and output circuits of the transistor. Self-bias of the transistor is employed in both these circuits. A more sophisticated oscillator employing a 2N247 transistor and utilizing a voltage divider-type bias system (figure 22C) is capable of operation up to 50 Mc. or so. The tuned circuit is placed in the collector, with a small emitter-collector capacitor providing feedback to the emitter electrode.

A P-N-P and an N-P-N transistor may be combined to form a complementary Hartley oscillator of high stability (figure 23). The collector of the P-N-P transistor is directly

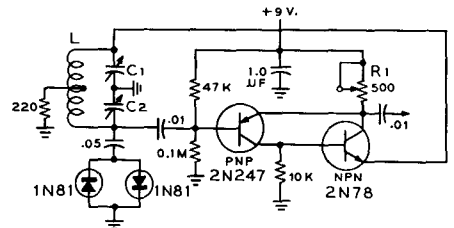

Figure 23
COMPLEMENTARY HARTLEY
OSCILLATOR

P-N-P and N-P-N transistors form high stability oscillator. Feedback between P-N-P emitter and N-P-N collector is controlled by R₁. 1N81 diodes are used as amplitude limiters. Frequency of oscillation is determined by L, C₁, C₂.

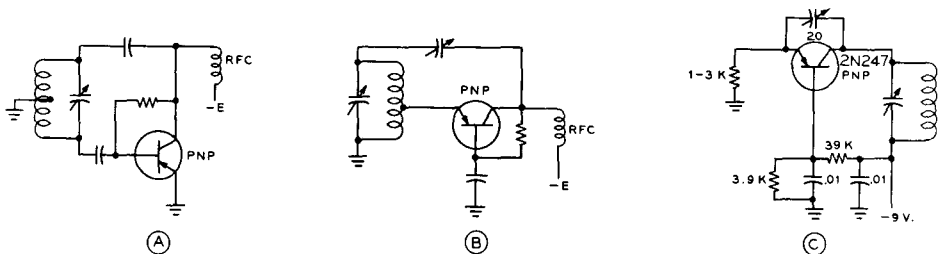

Figure 22
TYPICAL TRANSISTOR OSCILLATOR CIRCUITS

- A—Grounded Emitter Hartley
- B—Grounded Base Hartley
- C—2N247 Oscillator Suitable for 50 Mc. operation.

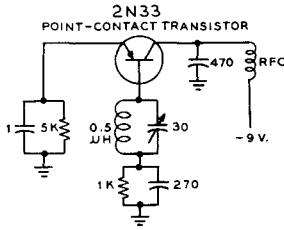

Figure 24
NEGATIVE RESISTANCE OF
POINT-CONTACT TRANSISTOR
PERMITS HIGH FREQUENCY
OSCILLATION (50 Mc) WITHOUT
WITHOUT NECESSITY OF
EXTERNAL FEEDBACK PATH.

center of the oscillator coil to eliminate loading of the tuned circuit.

Two germanium diodes are employed as amplitude limiters, further stabilizing amplifier operation. Because of the low circuit impedances, it is permissible to use extremely high-C in the oscillator tank circuit, effectively limiting oscillator temperature stability to variations in the tank inductance.

The point-contact transistor exhibits negative input and output resistances over part of its operating range, due to its unique ability to multiply the input current. This characteristic affords the use of oscillator circuitry having no external feedback paths (figure 24). A high impedance resonant circuit in the base lead produces circuit instability and oscillation at the resonant frequency of the L-C circuit. Positive emitter bias is used to insure thermal circuit stability.

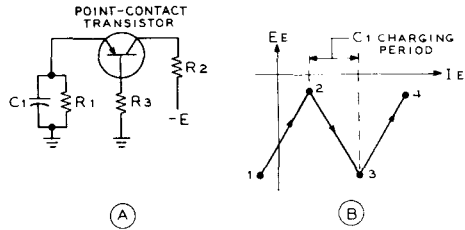

Figure 25
RELAXATION OSCILLATOR USING
POINT-CONTACT OR SURFACE
BARRIER TRANSISTORS.

Relaxation Oscillators Transistors have almost unlimited use in relaxation and R-C oscillator service. The negative resistance characteristic of the point contact transistor make it well suited to such application. Surface barrier transistors are also widely used in this service, as they have the highest alpha cutoff frequency among the group of "alpha-less-than-unity" transistors. Relaxation oscillators used for high speed counting require transistors capable of operation at repetition rates of 5 Mc. to 10 Mc.

A simple emitter controlled relaxation oscillator is shown in figure 25, together with its operating characteristic. The emitter of the transistor is biased to cutoff at the start of the cycle (point 1). The charge on the emitter capacitor slowly leaks to ground through the emitter resistor, R₁. Discharge time is determined by the time constant of R₁C₁. When the emitter voltage drops sufficiently low to permit the transistor to reach the negative resistance region (point 2) the emitter and collector resistances drop to a low value, and the collector

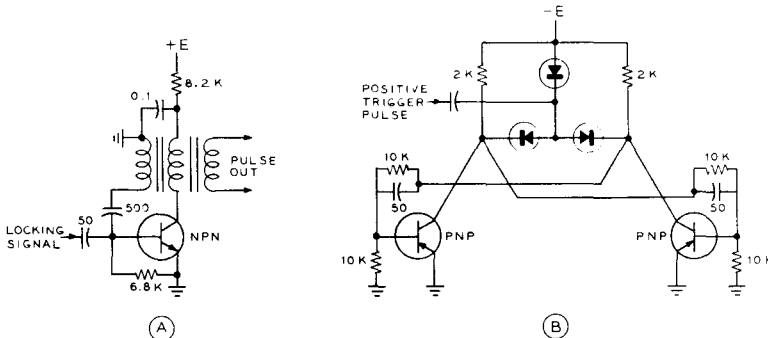
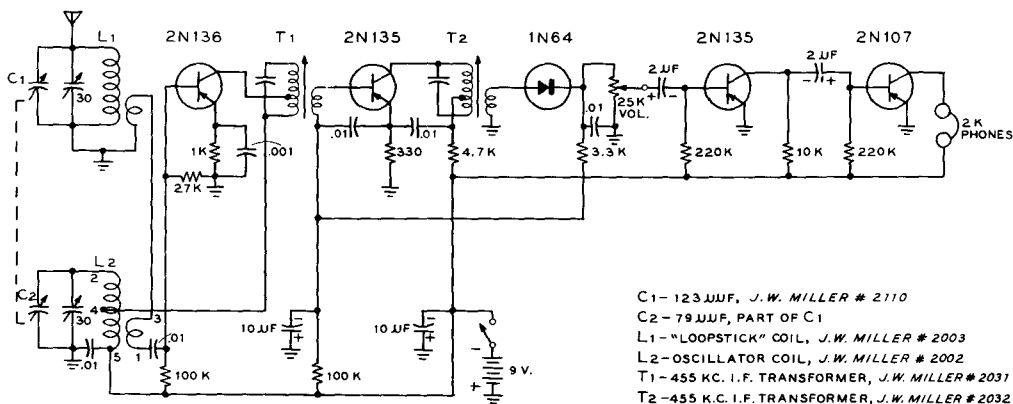

Figure 26
TRANSISTORIZED BLOCKING OSCILLATOR (A) AND ECCLES-JORDAN
BI-STABLE MULTIVIBRATOR (B).

High-alpha transistors must be employed in counting circuits to reduce effects of storage time caused by transit lag in transistor base.



C1-123JUF, J.W. MILLER # 2110
 C2-79JUF, PART OF C1
 L1-"LOOPSTICK" COIL, J.W. MILLER # 2003
 L2-OSCILLATOR COIL, J.W. MILLER # 2002
 T1-455 KC. I.F. TRANSFORMER, J.W. MILLER # 2031
 T2-455 KC. I.F. TRANSFORMER, J.W. MILLER # 2032

Figure 28
SCHEMATIC, TRANSISTORIZED BROADCAST BAND (500 - 1600 KC.) SUPERHETERO-DYNE RECEIVER.

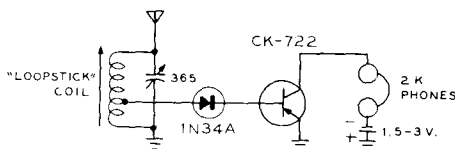

Figure 27
"WRIST RADIO" CAN BE MADE WITH LOOPSTICK, DIODE, AND INEXPENSIVE CK-722 TRANSISTOR. A TWENTY FOOT ANTENNA WIRE WILL PROVIDE GOOD RECEPTION IN STRONG SIGNAL AREAS.

current is limited only by the collector resistor, R_2 . The collector current is abruptly reduced by the charging action of the emitter capacitor C_1 (point 3), bringing the circuit back to the original operating point. The "spike" of collector current is produced during the charging period of C_1 . The duration of the pulse and the pulse repetition frequency (p.r.f.) are controlled by the values of C_1 , R_1 , R_2 , and R_3 .

Transistors may also be used as blocking oscillators (figure 26A). The oscillator may be synchronized by coupling the locking signal to the base circuit of the transistor. An oscillator of this type may be used to drive a flip-flop circuit as a counter. An Eccles-Jordan bi-stable flip-flop circuit employing surface-barrier transistors may be driven between "off" and "on" positions by an exciting pulse as shown in figure 26B. The first pulse drives the "on" transistor into saturation. This transistor remains in a highly conductive state until the second exciting pulse arrives. The transistor does not immediately return to the cut-off

state, since a time lapse occurs before the output waveform starts to decrease. This storage time is caused by the transit lag of the minority carriers in the base of the transistor. Proper circuit design and the use of high-alpha transistors can reduce the effects of storage time to a minimum. Driving pulses may be coupled to the multivibrator through steering diodes as shown in the illustration.

5-6 Transistor Circuits

With the introduction of the dollar transistor, many interesting and unusual experiments and circuits may be built up by the beginner in the transistor field. One of the most interesting is the "wrist watch" receiver, illustrated in figure 27. A diode and a transistor amplifier form a miniature broadcast receiver, which may be built in a small box and carried on the person. A single 1.5-volt penlite cell provides power for the transistor, and a short length of antenna wire will suffice in the vicinity of a local broadcasting station.

A transistorized superheterodyne for broadcast reception is shown in figure 28. No antenna is required, as a ferrite "loop-stick" is used for the r-f input circuit of the 2N136 mixer transistor. A miniature magnetic "hearing aid" type earphone may be employed with this receiver.

A simple phonograph amplifier designed for use with a high impedance crystal pickup is shown in figure 29. Two stages of amplification using 2N109 transistors are used to drive two 2N109 transistors in a class B configuration. Approximately 200 milliwatts of

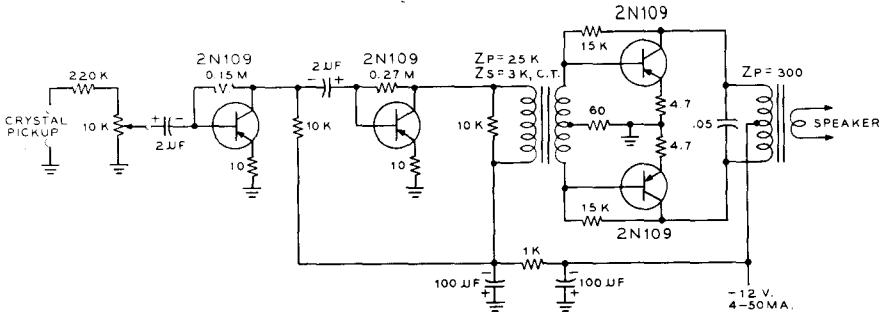

Figure 29
HIGH GAIN, LOW DISTORTION AUDIO AMPLIFIER, SUITABLE FOR USE
WITH A CRYSTAL PICKUP. POWER OUTPUT IS 250 MILLIWATTS.

power may be obtained with a battery supply of 12 volts. Peak current drain under maximum signal conditions is 40 ma. Other inter-

esting transistor projects will be shown in later chapters of this Handbook.

E & E TECHNI-SHEET

TABLE OF WROUGHT STEEL STANDARD PIPE
(BLACK OR GALVANIZED) RANDOM LENGTHS, 20-21 FEET

NOMINAL SIZE INCHES	O.D. INCHES	I.D. INCHES	POUNDS PER FOOT
1/8"	.405	.269	.244
1/4"	.540	.364	.424
3/8"	.675	.493	.567
1/2"	.840	.622	.850
3/4"	1.050	.824	1.130
1"	1.315	1.049	1.678
1 1/4"	1.660	1.380	2.272
1 1/2"	1.900	1.610	2.717
2"	2.375	2.067	3.652
2 1/2"	2.875	2.469	5.793
3"	3.500	3.068	7.575
3 1/2"	4.000	3.548	9.109
4"	4.500	4.026	10.790

TABLE OF ELECTRICAL METALLIC TUBING (EMT)
GALVANIZED, 10 FOOT LENGTHS

NOMINAL SIZE INCHES	O.D. INCHES	I.D. INCHES	POUNDS PER FOOT
3/8"	.577	.493	.250
1/2"	.706	.622	.321
3/4"	.922	.824	.488
1"	1.163	1.049	.711
1 1/4"	1.508	1.308	1.000
1 1/2"	1.738	1.610	1.180
2"	2.195	2.067	1.500

TABLE OF ALUMINUM ROD, 12 FOOT LENGTHS

	DIAMETER	WT. #/FT.	
	1/8"	.015	
	3/16"	.033	
	1/4"	.059	

Vacuum Tube Amplifiers

6-1 Vacuum Tube Parameters

The ability of the control grid of a vacuum tube to control large amounts of plate power with a small amount of grid energy allows the vacuum tube to be used as an amplifier. It is this ability of vacuum tubes to amplify an extremely small amount of energy up to almost any level without change in anything except amplitude which makes the vacuum tube such an extremely valuable adjunct to modern electronics and communication.

Symbols for Vacuum-Tube Parameters As an assistance in simplifying and shortening expressions involving vacuum-tube parameters, the following symbols will be used throughout this book:

Tube Constants

μ — amplification factor
 R_p — plate resistance
 G_m — transconductance
 μ_{sg} — grid-screen mu factor
 G_c — conversion transconductance (mixer tube)

Interelectrode Capacitances

C_{gk} — grid-cathode capacitance
 C_{gp} — grid-plate capacitance
 C_{pk} — plate-cathode capacitance
 C_{in} — input capacitance (tetrode or pentode)
 C_{out} — output capacitance (tetrode or pentode)

Electrode Potentials

E_{bb} — d-c plate supply voltage (a positive quantity)
 E_{cc} — d-c grid supply voltage (a negative quantity)
 E_{gm} — peak grid excitation voltage ($\frac{1}{2}$ total peak-to-peak grid swing)
 E_{pm} — peak plate voltage ($\frac{1}{2}$ total peak-to-peak plate swing)
 e_p — instantaneous plate potential
 e_g — instantaneous grid potential
 e_{pmin} — minimum instantaneous plate voltage
 e_{gmp} — maximum positive instantaneous grid voltage
 E_p — static plate voltage
 E_g — static grid voltage
 e_{co} — cutoff bias

Electrode Currents

I_b — average plate current
 I_c — average grid current
 I_{pm} — peak fundamental plate current
 I_{pmax} — maximum instantaneous plate current
 I_{gmax} — maximum instantaneous grid current
 I_p — static plate current
 I_g — static grid current

Other Symbols

P_i — plate power input
 P_o — plate power output
 P_d — plate dissipation
 P_d — grid driving power (grid plus bias losses)

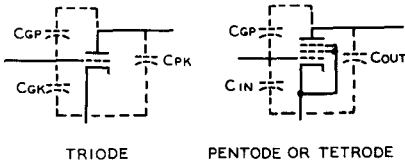

Figure 1
STATIC INTERELECTRODE CAPACITANCES WITHIN A TRIODE, PENTODE, OR TETRODE

P_g — grid dissipation
 N_p — plate efficiency (expressed as a decimal)
 θ_p — one-half angle of plate current flow
 θ_g — one-half angle of grid current flow
 R_L — load resistance
 Z_L — load impedance

Vacuum-Tube Constants The relationships between certain of the electrode potentials and currents within a vacuum tube are reasonably constant under specified conditions of operation. These relationships are called *vacuum-tube constants* and are listed in the data published by the manufacturers of vacuum tubes. The defining equations for the basic vacuum-tube constants are given in Chapter Four.

Interelectrode Capacitances and Miller Effect The values of interelectrode capacitance published in vacuum-tube tables are the static values measured, in the case of triodes for example, as shown in figure 1. The static capacitances are simply as shown in the drawing, but when a tube is operating as amplifier there is another consideration known as *Miller Effect* which causes the dynamic input capacitance to be different from the static value. The output capacitance of an amplifier is essentially the same as the static value given in the published tube tables. The grid-to-plate capacitance is also the same as the published static value, but since the C_{gp} acts as a small capacitance coupling energy back from the plate circuit to the grid circuit, the dynamic input capacitance is equal to the static value plus an amount (frequently much greater in the case of a triode) determined by the gain of the stage, the plate load impedance, and the C_{gp} feedback capacitance. The total value for an audio amplifier stage can be expressed in the following equation:

$$C_{gk}^{(\text{dynamic})} = C_{gk}^{(\text{static})} + (A + 1) C_{gp}$$

where C_{gk} is the grid-to-cathode capacitance,

C_{gp} is the grid-to-plate capacitance, and A is the stage gain. This expression assumes that the vacuum tube is operating into a resistive load such as would be the case with an audio stage working into a resistance plate load in the middle audio range.

The more complete expression for the input admittance (vector sum of capacitance and resistance) of an amplifier operating into any type of plate load is as follows:

$$\text{Input capacitance} = C_{gk} + (1 + A \cos \theta) C_{gp}$$

$$\text{Input resistance} = - \left(\frac{1}{\omega C_{gp}} \right) \frac{1}{A \sin \theta}$$

Where: C_{gk} = grid-to-cathode capacitance
 C_{gp} = grid-to-plate capacitance
 A = voltage amplification of the tube alone
 θ = phase angle of the plate load impedance, positive for inductive loads, negative for capacitive

It can be seen from the above that if the plate load impedance of the stage is capacitive or inductive, there will be a resistive component in the input admittance of the stage. The resistive component of the input admittance will be positive (tending to load the circuit feeding the grid) if the load impedance of the plate is capacitive, or it will be negative (tending to make the stage oscillate) if the load impedance of the plate is inductive.

Neutralization of Interelectrode Capacitance Neutralization of the effects of interelectrode capacitance is employed most frequently in the case of radio frequency power amplifiers. Before the introduction of the tetrode and pentode tube, triodes were employed as neutralized Class A amplifiers in receivers. This practice has been largely superseded in the present state of the art through the use of tetrode and pentode tubes in which the C_{gp} or feedback capacitance has been reduced to such a low value that neutralization of its effects is not necessary to prevent oscillation and instability.

6-2 Classes and Types of Vacuum-Tube Amplifiers

Vacuum-tube amplifiers are grouped into various classes and sub-classes according to the type of work they are intended to perform. The difference between the various classes is determined primarily by the value of average grid bias employed and the maximum value of

the exciting signal to be impressed upon the grid.

Class A Amplifier A Class A amplifier is an amplifier biased and supplied with excitation of such amplitude that plate current flows continuously (360° of the exciting voltage waveshape) and grid current does not flow at any time. Such an amplifier is normally operated in the center of the grid-voltage plate-current transfer characteristic and gives an output waveshape which is a substantial replica of the input waveshape.

Class A₁ Amplifier This is another term applied to the Class A amplifier in which grid current does not flow over any portion of the input wave cycle.

Class A₂ Amplifier This is a Class A amplifier operated under such conditions that the grid is driven positive over a portion of the input voltage cycle, but plate current still flows over the entire cycle.

Class AB₁ Amplifier This is an amplifier operated under such conditions of grid bias and exciting voltage that plate current flows for more than one-half the input voltage cycle but for less than the complete cycle. In other words the operating angle of plate current flow is appreciably greater than 180° but less than 360° . The suffix 1 indicates that grid current does not flow over any portion of the input cycle.

Class AB₂ Amplifier A Class AB₂ amplifier is operated under essentially the same conditions of grid bias as the Class AB₁ amplifier mentioned above, but the exciting voltage is of such amplitude that grid current flows over an appreciable portion of the input wave cycle.

Class B Amplifier A Class B amplifier is biased substantially to cutoff of plate current (without exciting voltage) so that plate current flows essentially over one-half the input voltage cycle. The operating angle of plate current flow is essentially 180° . The Class B amplifier is almost always excited to such an extent that grid current flows.

Class C Amplifier A Class C amplifier is biased to a value greater than the value required for plate current cutoff and is excited with a signal of such amplitude that grid current flows over an appreciable period of the input voltage waveshape. The angle of plate current flow in a Class C amplifier is appreciably less than 180° , or in other words, plate current flows appreciably

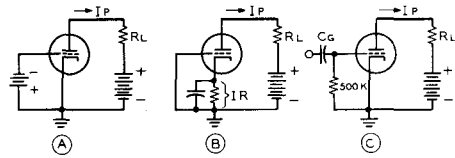

Figure 2
TYPES OF BIAS SYSTEMS

- A - Grid bias
- B - Cathode bias
- C - Grid leak bias

less than one-half the time. Actually, the conventional operating conditions for a Class C amplifier are such that plate current flows for 120° to 150° of the exciting voltage waveshape.

Types of Amplifiers There are three general types of amplifier circuits in use. These types are classified on the basis of the return for the input and output circuits. Conventional amplifiers are called *cathode return* amplifiers since the cathode is effectively grounded and acts as the common return for both the input and output circuits. The second type is known as a plate return amplifier or *cathode follower* since the plate circuit is effectively at ground for the input and output signal voltages and the output voltage or power is taken between cathode and plate. The third type is called a *grid-return* or *grounded-grid* amplifier since the grid is effectively at ground potential for input and output signals and output is taken between grid and plate.

6-3 Biasing Methods

The difference of potential between grid and cathode is called the *grid bias* of a vacuum tube. There are three general methods of providing this bias voltage. In each of these methods the purpose is to establish the grid at a potential with respect to the cathode which will place the tube in the desired operating condition as determined by its characteristics.

Grid bias may be obtained from a source of voltage especially provided for this purpose, as a battery or other d-c power supply. This method is illustrated in figure 2A, and is known as *fixed bias*.

A second biasing method is illustrated in figure 2B which utilizes a cathode resistor across which an IR drop is developed as a result of plate current flowing through it. The

cathode of the tube is held at a positive potential with respect to ground by the amount of the IR drop because the grid is at ground potential. Since the biasing voltage depends upon the flow of plate current the tube cannot be held in a cutoff condition by means of the *cathode bias* voltage developed across the cathode resistor. The value of this resistor is determined by the bias required and the plate current which flows at this value of bias, as found from the tube characteristic curves. A capacitor is shunted across the bias resistor to provide a low impedance path to ground for the a-c component of the plate current which results from an a-c input signal on the grid.

The third method of providing a biasing voltage is shown in figure 2C, and is called *grid-leak* bias. During the portion of the input cycle which causes the grid to be positive with respect to the cathode, grid current flows from cathode to grid, charging capacitor C_g . When the grid draws current, the grid-to-cathode resistance of the tube drops from an infinite value to a very low value, on the order of 1,000 ohms or so, making the charging time constant of the capacitor very short. This enables C_g to charge up to essentially the full value of the positive input voltage and results in the grid (which is connected to the low potential plate of the capacitor) being held essentially at ground potential. During the negative swing of the input signal no grid current flows and the discharge path of C_g is through the grid resistance which has a value of 500,000 ohms or so. The discharge time constant for C_g is, therefore, very long in comparison to the period of the input signal and only a small part of the charge on C_g is lost. Thus, the bias voltage developed by the discharge of C_g is substantially constant and the grid is not permitted to follow the positive portions of the input signal.

6-4 Distortion in Amplifiers

There are three main types of distortion that may occur in amplifiers: frequency distortion, phase distortion and amplitude distortion.

Frequency Distortion Frequency distortion may occur when some frequency components of a signal are amplified more than others. Frequency distortion occurs at low frequencies if coupling capacitors between stages are too small, or may occur at high frequencies as a result of the shunting effects of the distributed capacities in the circuit.

Phase Distortion In figure 3 an input signal consisting of a fundamental and a third harmonic is passed through

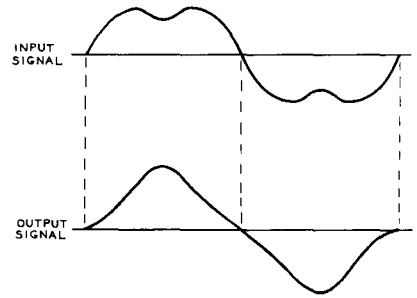

Figure 3
Illustration of the effect of phase distortion on input wave containing a third harmonic signal

a two stage amplifier. Although the amplitudes of both components are amplified by identical ratios, the output waveshape is considerably different from the input signal because the phase of the third harmonic signal has been shifted with respect to the fundamental signal. This phase shift is known as *phase distortion*, and is caused principally by the coupling circuits between the stages of the amplifier. Most coupling circuits shift the phase of a sine wave, but this has no effect on the shape of the output wave. However, when a complex wave is passed through the same coupling circuit, each component frequency of the waveshape may be shifted in phase by a different amount so that the output wave is not a faithful reproduction of the input waveshape.

Amplitude Distortion If a signal is passed through a vacuum tube that is operating on any non-linear part of its characteristic, amplitude distortion will occur. In such a region, a change in grid voltage does not result in a change in plate current which is directly proportional to the change in grid voltage. For example, if an amplifier is excited with a signal that overdrives the tubes, the resultant signal is distorted in amplitude, since the tubes operate over a non-linear portion of their characteristic.

6-5 Resistance-Capacitance Coupled Audio-Frequency Amplifiers

Present practice in the design of audio-frequency voltage amplifiers is almost exclusively to use resistance-capacitance coupling between the low-level stages. Both triodes and

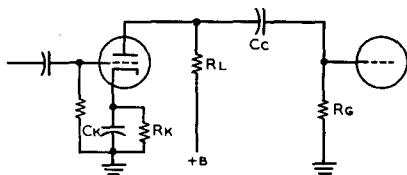

Figure 4
STANDARD CIRCUIT FOR RESISTANCE-CAPACITANCE COUPLED TRIODE AMPLIFIER STAGE

levels (from 0.01 to 5 volts peak on the grid of the tube) and use medium- μ triodes such as the 6J5 or high- μ triodes such as the 6SF5 or 6SL7-GT. Normal voltage gain for a single stage of this type is from 10 to 70, depending upon the tube chosen and its operating conditions. Triode tubes are normally used in the last voltage amplifier stage of an R-C amplifier since their harmonic distortion with large output voltage (25 to 75 volts) is less than with a pentode tube.

Voltage Gain per Stage The voltage gain per stage of a resistance-capacitance coupled triode amplifier can be calculated with the aid of the equivalent circuits and expressions for the mid-frequency, high-frequency, and low-frequency range given in figure 5.

A triode R-C coupled amplifier stage is normally operated with values of cathode resistor and plate load resistor such that the actual voltage on the tube is approximately one-half the d-c plate supply voltage. To

pentodes are used; triode amplifier stages will be discussed first.

R-C Coupled Triode Stages Figure 4 illustrates the standard circuit for a resistance-capacitance coupled amplifier stage utilizing a triode tube with cathode bias. In conventional audio-frequency amplifier design such stages are used at medium voltage

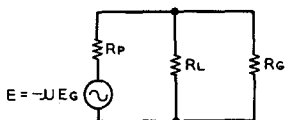

MID FREQUENCY RANGE

$$A = \frac{j R_L R_g}{R_p (R_L + R_g) + R_L R_g}$$

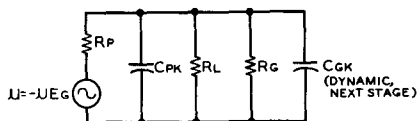

HIGH FREQUENCY RANGE

$$\frac{A \text{ HIGH FREQ.}}{A \text{ MID FREQ.}} = \frac{1}{\sqrt{1 + (R_{eq}/X_s)^2}}$$

$$R_{eq} = \frac{R_L}{1 + \frac{R_L}{R_g} + \frac{R_L}{R_p}}$$

$$X_s = \frac{1}{2\pi f (C_{pk} + C_{GK} \text{ (DYNAMIC)})}$$

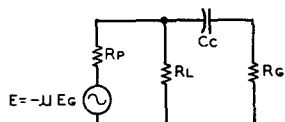

LOW FREQUENCY RANGE

$$\frac{A \text{ LOW FREQ.}}{A \text{ MID FREQ.}} = \frac{1}{\sqrt{1 + (X_c/R)^2}}$$

$$X_c = \frac{1}{2\pi f C_c}$$

$$R = R_g + \frac{R_L R_p}{R_L + R_p}$$

Figure 5

Equivalent circuits and gain equations for a triode R-C coupled amplifier stage. In using these equations, be sure to select the values of μ and R_p which are proper for the static current and voltages with which the tube will operate. These values may be obtained from curves published in the RCA Tube Handbook RC-16.

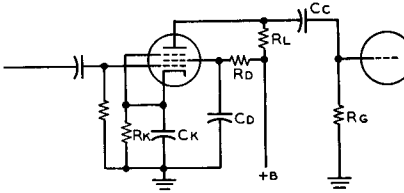

Figure 6
STANDARD CIRCUIT FOR RESISTANCE-CAPACITANCE COUPLED PENTODE AMPLIFIER STAGE

assist the designer of such stages, data on operating conditions for commonly used tubes is published in the RCA Tube Handbook RC-16. It is assumed, in the case of the gain equations of figure 5, that the cathode by-pass capacitor, C_k , has a reactance that is low with respect to the cathode resistor at the lowest frequency to be passed by the amplifier stage.

R-C Coupled Pentode Stages Figure 6 illustrates the standard circuit for a resistance-capacitance coupled pentode amplifier stage. Cathode bias is used and the screen voltage is supplied through a dropping resistor from the plate voltage supply. In conventional audio-frequency amplifier design such stages are normally used at low voltage levels (from 0.00001 to 0.1 volts peak on the grid of the tube) and use moderate- G_m pentodes

such as the 6SJ7. Normal voltage gain for a stage of this type is from 60 to 250, depending upon the tube chosen and its operating conditions. Pentode tubes are ordinarily used the first stage of an R-C amplifier where the high gain which they afford is of greatest advantage and where only a small voltage output is required from the stage.

The voltage gain per stage of a resistance-capacitance coupled pentode amplifier can be calculated with the aid of the equivalent circuits and expressions for the mid-frequency, high-frequency, and low-frequency range given in figure 7.

To assist the designer of such stages, data on operating conditions for commonly used types of tubes is published in the RCA Tube Handbook RC-16. It is assumed, in the case of the gain equations of figure 7, that the cathode by-pass capacitor, C_k , has a reactance that is low with respect to the cathode resistor at the lowest frequency to be passed by the stage. It is additionally assumed that the reactance of the screen by-pass capacitor C_d , is low with respect to the screen dropping resistor, R_d , at the lowest frequency to be passed by the amplifier stage.

Cascade Voltage Amplifier Stages When voltage amplifier stages are operated in such a manner that the output voltage of the first is fed to the grid of the second, and so forth, such stages are said to be *cascaded*. The total voltage gain of cascaded amplifier

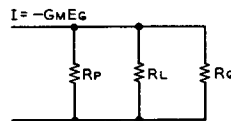

MID FREQUENCY RANGE

$$A = G_m R_{EQ}$$

$$R_{EQ} = \frac{R_L}{1 + \frac{R_L}{R_G} + \frac{R_L}{R_P}}$$

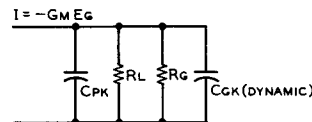

HIGH FREQUENCY RANGE

$$\frac{A \text{ HIGH FREQ.}}{A \text{ MID FREQ.}} = \frac{1}{\sqrt{1 + (R_{EQ}/X_s)^2}}$$

$$R_{EQ} = \frac{R_L}{1 + \frac{R_L}{R_G} + \frac{R_L}{R_P}}$$

$$X_s = \frac{1}{2\pi f (C_{PK} + C_{GK} \text{ (DYNAMIC)})}$$

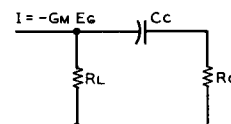

LOW FREQUENCY RANGE

$$\frac{A \text{ LOW FREQ.}}{A \text{ MID FREQ.}} = \frac{1}{\sqrt{1 + (X_c/R)^2}}$$

$$X_c = \frac{1}{2\pi f C_c}$$

$$R = R_G + \frac{R_L R_P}{R_L + R_P}$$

Figure 7

Equivalent circuits and gain equations for a pentode R-C coupled amplifier stage. In using these equations be sure to select the values of G_m and R_p which are proper for the static currents and voltages with which the tube will operate. These values may be obtained from curves published in the RCA Tube Handbook RC-16.

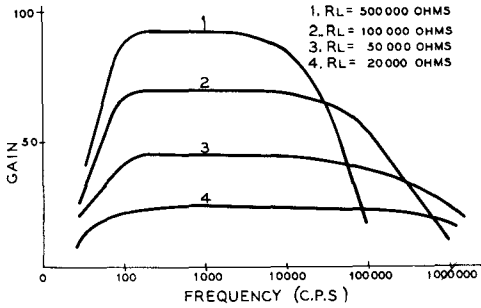
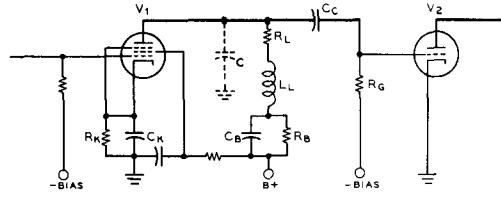

Figure 8

The variation of stage gain with frequency in an r-c coupled pentode amplifier for various values of plate load resistance



MID-FREQUENCY GAIN = $G_{M V1} R_L$

HIGH-FREQUENCY GAIN = $G_{M V1} Z_{\text{COUPLING NETWORK}}$

$C = C_{OUT V1} + C_{IN V2} + C_{DISTRIBUTED}$

FOR COMPROMISE HIGH FREQUENCY EQUALIZATION:

$X_{LL} = 0.5 X_C \text{ AT } F_C$

$R_L = X_C \text{ AT } F_C$

WHERE: F_C = CUTOFF FREQUENCY OF AMPLIFIER

LL = PEAKING INDUCTOR

FOR COMPROMISE LOW FREQUENCY EQUALIZATION:

$R_B = R_K (G_{M V1} R_L)$

$R_B C_B = R_K C_K$

$C_K = 25 \text{ TO } 50 \mu\text{FD. IN PARALLEL WITH } .001 \text{ MICA}$

$C_B = \text{CAPACITANCE FROM ABOVE WITH } .001 \text{ MICA IN PARALLEL}$

Figure 9

SIMPLE COMPENSATED VIDEO AMPLIFIER CIRCUIT

Resistor R_L in conjunction with coil L_L serves to flatten the high-frequency response of the stage, while C_B and R_B serve to equalize the low-frequency response of this simple video amplifier stage.

stages is obtained by taking the product of the voltage gains of each of the successive stages.

Sometimes the voltage gain of an amplifier stage is rated in decibels. Voltage gain is converted into decibels gain through the use of the following expression: $db = 20 \log_{10} A$, where A is the voltage gain of the stage. The total gain of cascaded voltage amplifier stages can be obtained by adding the number of decibels gain in each of the cascaded stages.

R-C Amplifier Response A typical frequency response curve for an R-C coupled audio amplifier is shown in figure 8.

It is seen that the amplification is poor for the extreme high and low frequencies. The reduced gain at the low frequencies is caused by the loss of voltage across the coupling capacitor. In some cases, a low value of coupling capacitor is deliberately chosen to reduce the response of the stage to hum, or to attenuate the lower voice frequencies for communication purposes. For high fidelity work the product of the grid resistor in ohms times the coupling capacitor in microfarads should equal 25,000. (i.e.: $500,000 \text{ ohms} \times 0.05 \mu\text{fd} = 25,000$).

The amplification of high frequencies falls off because of the Miller effect of the subsequent stage, and the shunting effect of residual circuit capacities. Both of these effects may be minimized by the use of a low value of plate load resistor.

Grid Leak Bias for High Mu Triodes The correct operating bias for a high-mu triode such as the 6SL7, is fairly critical, and will be found to be highly variable from tube to tube because of minute variations in contact potential within the tube itself. A satisfactory bias method is to use grid leak bias, with a grid resistor of one to ten meg-

ohms connected directly between grid and cathode of the tube. The cathode is grounded. Grid current flows at all times, and the effective input resistance is about one-half the resistance value of the grid leak. This circuit is particularly well suited as a high gain amplifier following low output devices, such as crystal microphones, or dynamic microphones.

R-C Amplifier General Characteristics A resistance-capacity coupled amplifier can be designed to provide

a good frequency response for almost any desired range. For instance, such an amplifier can be built to provide a fairly uniform amplification for frequencies in the audio range of about 100 to 20,000 cycles. Changes in the values of coupling capacitors and load resistors can extend this frequency range to cover the very wide range required for video service. However, extension of the range can only be obtained at the cost of reduced overall amplification. Thus the R-C method of coupling allows good frequency response with minimum distortion, but low amplification. Phase distortion is less with R-C coupling

than with other types, except direct coupling. The R-C amplifier may exhibit tendencies to "motorboat" or oscillate if it is used with a high impedance plate supply.

6-6 Video-Frequency Amplifiers

A video-frequency amplifier is one which has been designed to pass frequencies from the lower audio range (lower limit perhaps 50 cycles) to the middle r-f range (upper limit perhaps 4 to 6 megacycles). Such amplifiers, in addition to passing such an extremely wide frequency range, must be capable of amplifying this range with a minimum of amplitude, phase, and frequency distortion. Video amplifiers are commonly used in television, pulse communication, and radar work.

Tubes used in video amplifiers must have a high ratio of G_m to capacitance if a usable gain per stage is to be obtained. Commonly available tubes which have been designed for or are suitable for use in video amplifiers are: 6AU6, 6AG5, 6AK5, 6CB6, 6AC7, 6AG7, and 6K6-GT. Since, at the upper frequency limits of a video amplifier the input and output shunting capacitances of the amplifier tubes have rather low values of reactance, low values of coupling resistance along with peaking coils or other special interstage coupling impedances are usually used to flatten out the gain/frequency and hence the phase/frequency characteristic of the amplifier. Recommended operating conditions along with expressions for calculation of gain and circuit values are given in figure 9. Only a simple two-terminal interstage coupling network is shown in this figure.

The performance and gain-per-stage of a video amplifier can be improved by the use of increasingly complex two-terminal interstage coupling networks or through the use of four-terminal coupling networks or filters between successive stages. The reader is referred to Terman's "*Radio Engineer's Handbook*" for design data on such interstage coupling networks.

6-7 Other Interstage Coupling Methods

Figure 10 illustrates, in addition to resistance-capacitance interstage coupling, seven additional methods in which coupling between two successive stages of an audio-frequency amplifier may be accomplished. Although

resistance-capacitance coupling is most commonly used, there are certain circuit conditions wherein coupling methods other than resistance capacitance are more effective.

Transformer Coupling Transformer coupling, as illustrated in figure 10B, is seldom used at the present time between two successive single-ended stages of an audio amplifier. There are several reasons why resistance coupling is favored over transformer coupling between two successive single-ended stages. These are: (1) a transformer having frequency characteristics comparable with a properly designed R-C stage is very expensive; (2) transformers, unless they are very well shielded, will pick up inductive hum from nearby power and filament transformers; (3) the phase characteristics of step-up interstage transformers are poor, making very difficult the inclusion of a transformer of this type within a feedback loop; and (4) transformers are heavy.

However, there is one circuit application where a step-up interstage transformer is of considerable assistance to the designer; this is the case where it is desired to obtain a large amount of voltage to excite the grid of a cathode follower or of a high-power Class A amplifier from a tube operating at a moderate plate voltage. Under these conditions it is possible to obtain a peak voltage on the secondary of the transformer of a value somewhat greater than the d-c plate supply voltage of the tube supplying the primary of the transformer.

Push-Pull Transformer Interstage Coupling Push-pull transformer coupling between two stages is illustrated in figure 10C. This interstage coupling arrangement is fairly commonly used. The system is particularly effective when it is desired, as in the system just described, to obtain a fairly high voltage to excite the grids of a high-power audio stage. The arrangement is also very good when it is desired to apply feedback to the grids of the push-pull stage by applying the feedback voltage to the low-potential sides of the two push-pull secondaries.

Impedance Coupling Impedance coupling between two stages is shown in figure 10D.

This circuit arrangement is seldom used, but it offers one strong advantage over R-C interstage coupling. This advantage is the fact that, since the operating voltage on the tube with the impedance in the plate circuit is the plate supply voltage, it is possible to obtain approximately twice the peak voltage output that it is possible to obtain with R-C coupling. This is because, as has been

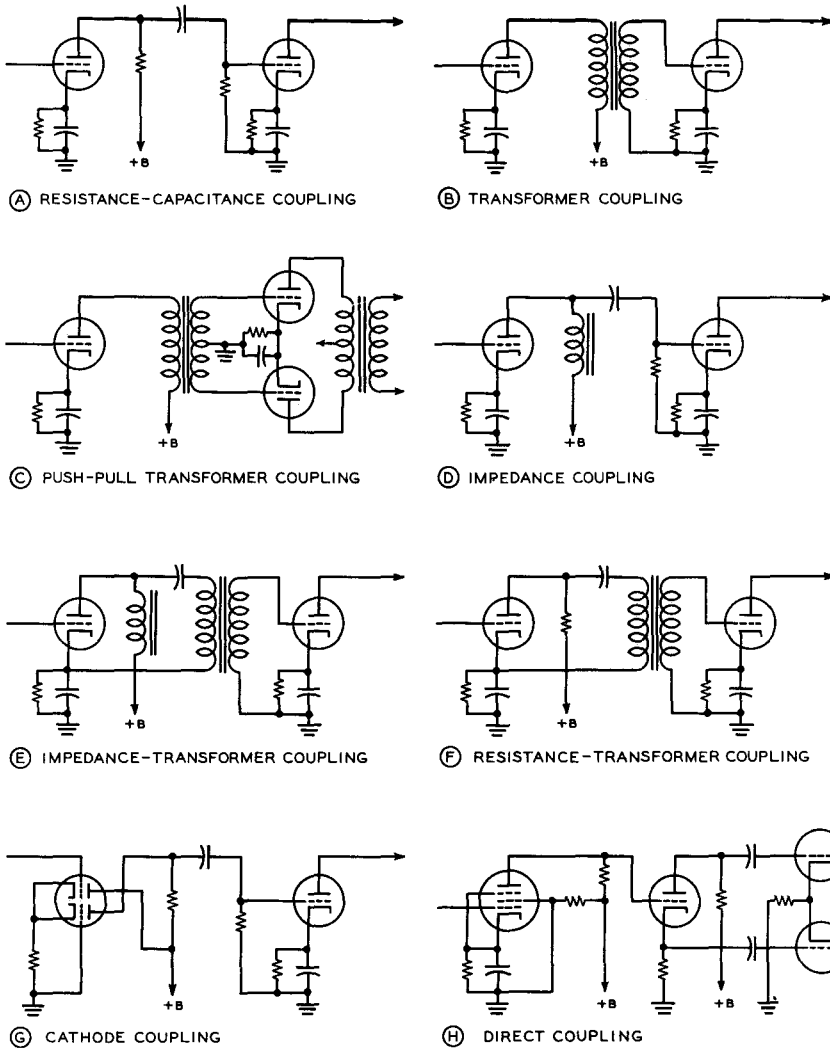

Figure 10
 INTERSTAGE COUPLING METHODS FOR AUDIO FREQUENCY VOLTAGE AMPLIFIERS

mentioned before, the d-c plate voltage on an R-C stage is approximately one-half the plate supply voltage.

Impedance-Transformer and Resistance-Transformer Coupling These two circuit arrangements, illustrated in figures 10E and 10F,

are employed when it is desired to use transformer coupling for the reasons cited above, but where it is desired that the d-c plate current of the amplifier

stage be isolated from the primary of the coupling transformer. With most types of high-permeability wide-response transformers it is necessary that there be no direct-current flow through the windings of the transformer. The impedance-transformer arrangement of figure 10E will give a higher voltage output from the stage but is not often used since the plate coupling impedance (choke) must have very high inductance and very low distributed capacitance in order not to restrict the range of

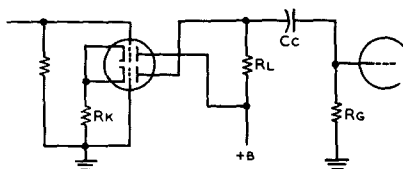

$$\begin{aligned}
 G M' &= -G M \frac{G}{2G+1} & G &= R_K G_m \left(1 + \frac{1}{\mu}\right) \\
 R P' &= R_P \frac{2G+1}{G+1} & R_K &= \text{CATHODE RESISTOR} \\
 \mu' &= -\mu \frac{G}{G+1} & G M &= G M \text{ OF EACH TUBE} \\
 & & \mu &= \mu \text{ OF EACH TUBE} \\
 & & R_P &= R_P \text{ OF EACH TUBE}
 \end{aligned}$$

EQUIVALENT FACTORS INDICATED ABOVE BY (') ARE THOSE OBTAINED BY USING AN AMPLIFIER WITH A PAIR OF SIMILAR TUBE TYPES IN CIRCUIT SHOWN ABOVE.

Figure 11

Equivalent factors for a pair of similar triodes operating as a cathode-coupled audio-frequency voltage amplifier.

the transformer which it and its associated tube feed. The resistance-transformer arrangement of figure 10F is ordinarily quite satisfactory where it is desired to feed a transformer from a voltage amplifier stage with no d.c. in the transformer primary.

Cathode Coupling The cathode coupling arrangement of figure 10G has been widely used only comparatively recently. One outstanding characteristic of such a circuit is that there is no phase reversal between the grid and the plate circuit. All other common types of interstage coupling are accompanied by a 180° phase reversal between the grid circuit and the plate circuit of the tube.

Figure 11 gives the expressions for determining the appropriate factors for an equivalent triode obtained through the use of a pair of similar triodes connected in the cathode-coupled circuit shown. With these equivalent triode factors it is possible to use the expressions shown in figure 5 to determine the gain of the stage at different frequencies. The input capacitance of such a stage is less than that of one of the triodes, the effective grid-to-plate capacitance is very much less (it is so much less that such a stage may be used as an r-f amplifier without neutralization), and the output capacitance is approximately equal to the grid-to-plate capacitance of one of the triode sections. This circuit is particularly effective with tubes such as the 6J6, 6N7, and 6SN7-GT which have two similar triodes in one envelope. An appropriate value of cathode resistor to use for such a stage is the value which would be used for the cathode resistor of a conventional amplifier using one of the

same type tubes with the values of plate voltage and load resistance to be used for the cathode-coupled stage.

Inspection of the equations in figure 11 shows that as the cathode resistor is made smaller, to approach zero, the G_m approaches zero, the plate resistance approaches the R_p of one tube, and the μ approaches zero. As the cathode resistor is made very large the G_m approaches one half that of a single tube of the same type, the plate resistance approaches twice that of one tube, and the μ approaches the same value as one tube. But since the G_m of each tube decreases as the cathode resistor is made larger (since the plate current will decrease on each tube) the optimum value of cathode resistor will be found to be in the vicinity of the value mentioned in the previous paragraph.

Direct Coupling Direct coupling between successive amplifier stages (plate of first stage connected directly to the grid of the succeeding stage) is complicated by the fact that the grid of an amplifier stage must be operated at an average negative potential with respect to the cathode of that stage. However, if the cathode of the second amplifier stage can be operated at a potential more positive than the plate of the preceding stage by the amount of the grid bias on the second amplifier stage, this direct connection between the plate of one stage and the grid of the succeeding stage can be used. Figure 10H illustrates an application of this principle in the coupling of a pentode amplifier stage to the grid of a "hot-cathode" phase inverter. In this arrangement the values of cathode, screen, and plate resistor in the pentode stage are chosen such that the plate of the pentode is at approximately 0.3 times the plate supply potential. The succeeding phase-inverter stage then operates with conventional values of cathode and plate resistor (same value of resistance) in its normal manner. This type of phase inverter is described in more detail in the section to follow.

6-8 Phase Inverters

It is necessary in order to excite the grids of a push-pull stage that voltages equal in amplitude and opposite in polarity be applied to the two grids. These voltages may be obtained through the use of a push-pull input transformer such as is shown in figure 10C. It is possible also, without the attendant bulk and expense of a push-pull input transformer, to obtain voltages of the proper polarity and

phase through the use of a so-called *phase-inverter* stage. There are a large number of phase inversion circuits which have been developed and applied but the three shown in figure 12 have been found over a period of time to be the most satisfactory from the point of view of the number of components required and from the standpoint of the accuracy with which the two out-of-phase voltages are held to the same amplitude with changes in supply voltage and changes in tubes.

All of these vacuum tube phase inverters are based upon the fact that a 180° phase shift occurs within a vacuum tube between the grid input voltage and the plate output voltage. In certain circuits, the fact that the grid input voltage and the voltage appearing across the cathode bias resistor are in phase is used for phase inversion purposes.

"Hot-Cathode" Figure 12A illustrates the hot-cathode type of phase inverter. This type of phase inverter is the simplest of the three types since it requires only one tube and a minimum of circuit components. It is particularly simple when directly coupled from the plate of a pentode amplifier stage as shown in figure 10H. The circuit does, however, possess the following two disadvantages: (1) the cathode of the tube must run at a potential of approximately 0.3 times the plate supply voltage above the heater when a grounded common heater winding is used for this tube as well as the other heater-cathode tubes in a receiver or amplifier; (2) the circuit actually has a loss in voltage from its input to either of the output grids—about 0.9 times the input voltage will be applied to each of these grids. This does represent a voltage gain of about 1.8 in *total* voltage output with respect to input (grid-to-grid output voltage) but it is still small with respect to the other two phase inverter circuits shown.

Recommended component values for use with a 6J5 tube in this circuit are shown in figure 12A. If it is desired to use another tube in this circuit, appropriate values for the operation of that tube as a conventional amplifier can be obtained from manufacturer's tube data. The value of R_L obtained should be divided by two, and this new value of resistance placed in the circuit as R_L . The value of R_k from tube manual tables should then be used as R_{k1} in this circuit, and then the total of R_{k1} and R_{k2} should be equal to R_L .

"Floating Paraphase" An alternate type of phase inverter sometimes called the "floating paraphase" is illustrated in figure 12B. This circuit is quite often used with a 6N7

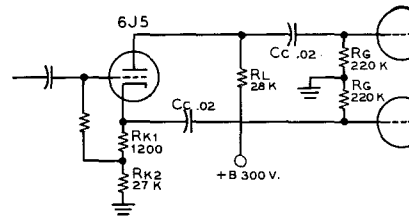

(A) "HOT CATHODE" PHASE INVERTER

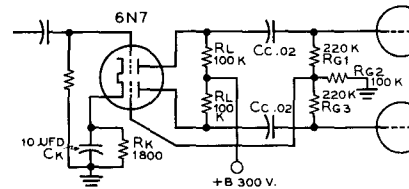

(B) "FLOATING PARAPHASE" PHASE INVERTER

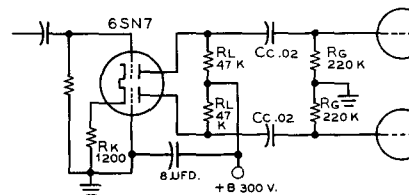

(C) CATHODE COUPLED PHASE INVERTER

Figure 12
THREE POPULAR PHASE-INVERTER CIRCUITS WITH RECOMMENDED VALUES FOR CIRCUIT COMPONENTS

tube, and appropriate values for the 6N7 tube in this application are shown. The circuit shown with the values given will give a voltage gain of approximately 21 from the input grid to each of the grids of the succeeding stage. It is capable of approximately 70 volts peak output to each grid.

The circuit inherently has a small unbalance in output voltage. This unbalance can be eliminated, if it is required for some special application, by making the resistor R_{g1} a few per cent lower in resistance value than R_{g3} .

Cathode-Coupled The circuit shown in figure 12C gives approximately one-half the voltage gain from the input grid to either of the grids of the succeeding stage that would be obtained from a single tube of the same type operating as a conventional R-C amplifier stage. Thus, with a 6SN7-GT tube as shown (two 6J5's in one

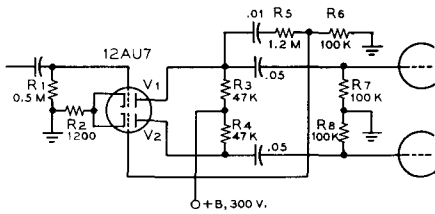

Figure 13
VOLTAGE DIVIDER PHASE
INVERTER

envelope) the voltage gain from the input grid to either of the output grids will be approximately 7 — the gain is, of course, 14 from the input to both output grids. The phase characteristics are such that the circuit is commonly used in deriving push-pull deflection voltage for a cathode-ray tube from a signal ended input signal.

The first half of the 6SN7 is used as an amplifier to increase the amplitude of the applied signal to the desired level. The second half of the 6SN7 is used as an inverter and amplifier to produce a signal of the same amplitude but of opposite polarity. Since the common cathode resistor, R_k , is not by-passed the voltage across it is the algebraic sum of the two plate currents and has the same shape and polarity as the voltage applied to the input grid of the first half of the 6SN7. When a signal, e , is applied to the input circuit, the effective grid-cathode voltage of the first section is $Ae/2$, when A is the gain of the first section. Since the grid of the second section of the 6SN7 is grounded, the effect of the signal voltage across R_k (equal to $e/2$ if R_k is the proper value) is the same as though a signal of the same amplitude but of opposite polarity were applied to the grid. The output of the second section is equal to $-Ae/2$ if the plate load resistors are the same for both tube sections.

Voltage Divider Phase Inverter A commonly used phase inverter is shown in figure 13.

The input section (V_1) is connected as a conventional amplifier. The output voltage from V_1 is impressed on the voltage divider R_5 - R_6 . The values of R_5 and R_6 are in such a ratio that the voltage impressed upon the grid of V_2 is $1/A$ times the output voltage of V_1 , where A is the amplification factor of V_1 . The output of V_2 is then of the

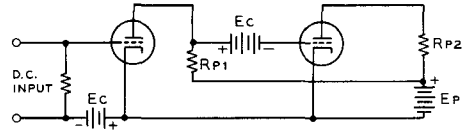

Figure 14
DIRECT COUPLED
D-C AMPLIFIER

same amplitude as the output of V_1 , but of opposite phase.

6.9 D-C Amplifiers

Direct current amplifiers are special types used where amplification of very slow variations in voltage, or of d-c voltages is desired. A simple d-c amplifier consists of a single tube with a grid resistor across the input terminals, and the load in the plate circuit.

Basic D-C Amplifier Circuit

A simple d-c amplifier circuit is shown in figure 14, wherein the

grid of one tube is connected directly to the plate of the preceding tube in such a manner that voltage changes on the grid of the first tube will be amplified by the system. The voltage drop across the plate coupling resistor is impressed directly upon the grid of the second tube, which is provided with enough negative grid bias to balance out the excessive voltage drop across the coupling resistor. The grid of the second tube is thus maintained in a slightly negative position.

The d-c amplifier will provide good low frequency response, with negligible phase distortion. High frequency response is limited by the shunting effect of the tube capacitances, as in the normal resistance coupled amplifier.

A common fault with d-c amplifiers of all types is static instability. Small changes in the filament, plate, or grid voltages cannot be distinguished from the exciting voltage. Regulated power supplies and special balancing circuits have been devised to reduce the effects of supply variations on these amplifiers. A successful system is to apply the plate potential in phase to two tubes, and to apply the exciting signal to a push-pull grid

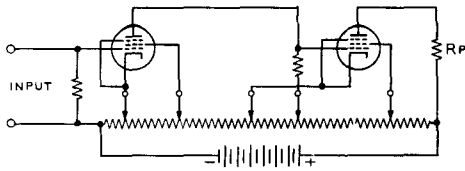

Figure 15
LOFTIN-WHITE
D-C AMPLIFIER

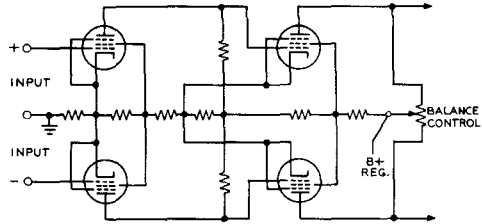

Figure 16
PUSH-PULL D-C AMPLIFIER
WITH EITHER SINGLE-ENDED
OR PUSH-PULL INPUT

circuit configuration. If the two tubes are identical, any change in electrode voltage is balanced out. The use of negative feedback can also greatly reduce drift problems.

The "Loftin-White" Circuit Two d-c amplifier stages may be arranged, so that their plate supplies are effectively in series, as illustrated in figure 15. This is known as a *Loftin-White* amplifier. All plate and grid voltages may be obtained from one master power supply instead of separate grid and plate supplies. A push-pull version of this amplifier (figure 16) can be used to balance out the effects of slow variations in the supply voltage.

6-10 Single-ended Triode Amplifiers

Figure 17 illustrates five circuits for the operation of Class A triode amplifier stages. Since the cathode current of a triode Class A₁ (no grid current) amplifier stage is constant with and without excitation, it is common practice to operate the tube with cathode bias. Recommended operating conditions in regard to plate voltage, grid bias, and load impedance for conventional triode amplifier stages are given in the RCA Tube Manual, RC-16.

Extended Class A Operation It is possible, under certain conditions to operate single-ended triode amplifier stages (and pentode and tetrode stages as well) with grid excitation of sufficient amplitude that grid current is taken by the tube on peaks. This type of operation is called Class A₂ and

is characterized by increased plate-circuit efficiency over straight Class A₁ amplification without grid current. The normal Class A₁ amplifier power stage will operate with a plate circuit efficiency of from 20 per cent to perhaps 35 per cent. Through the use of Class A₂ operation it is possible to increase this plate circuit efficiency to approximately 38 to 45 per cent. However, such operation requires careful choice of the value of plate load impedance, a grid bias supply with good regulation (since the tube draws grid current on peaks although the plate current does not change with signal), and a driver tube with moderate power capability to excite the grid of the Class A₂ tube.

Figures 17D and 17E illustrate two methods of connection for such stages. Tubes such as the 845, 849, and 304TL are suitable for such a stage. In each case the grid bias is approximately the same as would be used for a Class A₁ amplifier using the same tube, and as mentioned before, fixed bias must be used along with an audio driver of good regulation—preferably a triode stage with a 1:1 or step-down driver transformer. In each case it will be found that the correct value of plate load impedance will be increased about 40 per cent over the value recommended by the tube manufacturer for Class A₁ operation of the tube.

Operation Characteristics of a Triode Power Amplifier A Class A power amplifier operates in such a way as to amplify as faithfully as possible the waveform applied to the grid of the tube. Large power output is of more importance than high voltage amplification, consequently gain characteristics may be sacrificed in power tube design to obtain more important power handling capabilities. Class A power tubes, such as the 45, 2A3 and 6AS7 are characterized by a low amplification factor, high plate dissipation and relatively high filament emission.

The operating characteristics of a Class A

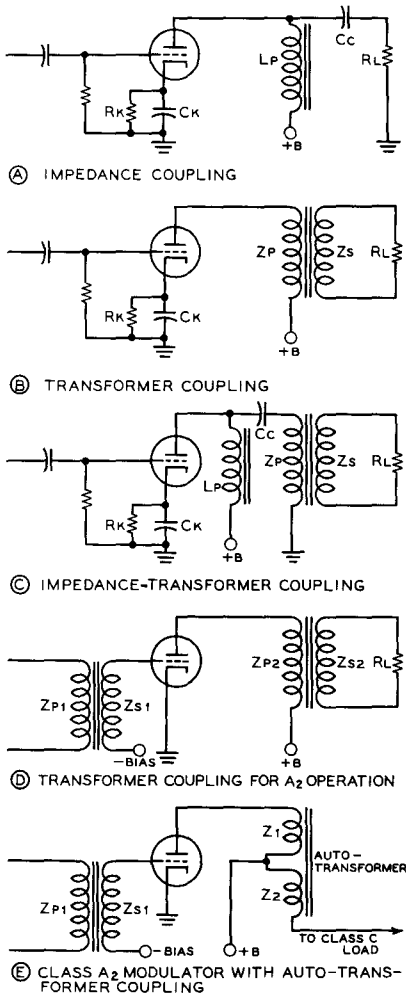

Figure 17

Output coupling arrangements for single-ended Class A triode audio-frequency power amplifiers.

triode amplifier employing an output transformer-coupled load may be calculated from the plate family of curves for the particular tube in question by employing the following steps:

- 1- The load resistance should be approximately twice the plate resistance of the tube for maximum undistorted power output. Remember this fact for a quick check on calculations.
- 2- Calculate the zero-signal bias voltage (E_g).

$$E_g = \frac{-(0.68 \times E_{bb})}{\mu}$$

Where E_{bb} is the actual plate voltage of the Class A stage, and μ is the amplification factor of the tube.

- 3- Locate the E_g bias point on the I_p vs. E_p graph where the E_g bias line crosses the plate voltage line, as shown in figure 18. Call this point P.
- 4- Locate on the plate family of curves the value of zero-signal plate current, I_p , corresponding to the operating point, P.
- 5- Locate $2 \times I_p$ (twice the value of I_p) on the plate current axis (Y-axis). This point corresponds to the value of maximum signal plate current, i_{max} .
- 6- Locate point x on the d-c bias curve at zero volts ($E_g = 0$), corresponding to the value of i_{max} .
- 7- Draw a straight line (x - y) through points x and P. This line is the load resistance line. Its slope corresponds to the value of the load resistance.
- 8- Load Resistance, (in ohms)

$$R_L = \frac{e_{max} - e_{min}}{i_{max} - i_{min}}$$

where e is in volts, i is in amperes, and R_L is in ohms.

- 9- Check: Multiply the zero-signal plate current, I_p , by the operating plate voltage, E_p . If the plate dissipation rating of the tube is exceeded, it is necessary to increase the bias (E_g) on the tube so that the plate dissipation falls within the maximum rating of the tube. If this step is taken, operations 2 through 8 must be repeated with the new value of E_g .
- 10- For maximum power output, the peak a-c grid voltage on the tube should swing to $2E_g$ on the negative cycle, and to zero-bias on the positive cycle. At the peak of the negative swing, the plate voltage reaches e_{max} and the plate current drops to i_{min} . On the positive swing of the grid signal, the plate voltage drops to e_{min} and the plate current reaches i_{max} . The power output of the tube is: Power Output (watts)

$$P_o = \frac{(i_{max} - i_{min}) \times (e_{max} - e_{min})}{8}$$

where i is in amperes and e is in volts.

- 11- The second harmonic distortion generated in a single-ended Class A triode amplifier, expressed as a percentage of the fundamental output signal is:

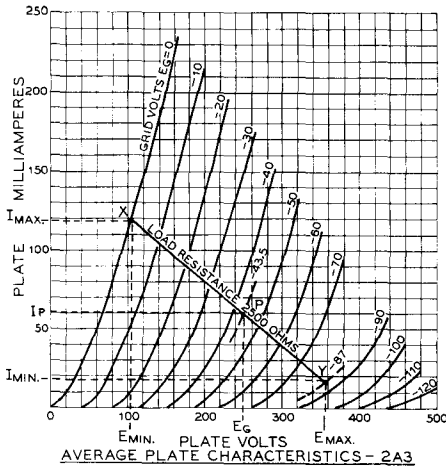

$\mu = 4.2$ $R_p = 800$ OHMS
 PLATE DISSIPATION = 15 WATTS

LOAD RESISTANCE

$$R_L = \frac{E_{MAX} - E_{MIN}}{I_{MAX} - I_{MIN}} \text{ OHMS}$$

POWER OUTPUT

$$P_o = \frac{(I_{MAX} - I_{MIN})(E_{MAX} - E_{MIN})}{8} \text{ WATTS}$$

SECOND HARMONIC DISTORTION

$$D_2 = \frac{\frac{(I_{MAX} + I_{MIN}) - I_p}{2}}{I_{MAX} - I_{MIN}} \times 100 \text{ PERCENT}$$

Figure 18

Formulas for determining the operating conditions for a Class A triode single-ended audio-frequency power output stage. A typical load line has been drawn on the average plate characteristics of a type 2A3 tube to illustrate the procedure.

% 2d harmonic =

$$\frac{\frac{(i_{max} - i_{min})}{2} - I_p}{i_{max} - i_{min}} (\times 100)$$

Figure 18 illustrates the above steps as applied to a single Class A 2A3 amplifier stage.

6-11 Single-ended Pentode Amplifiers

Figure 19 illustrates the conventional circuit for a single-ended tetrode or pentode amplifier stage.

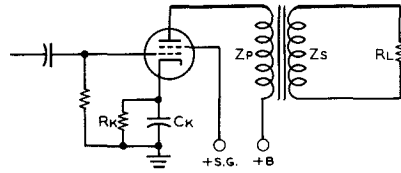

Figure 19

Normal single-ended pentode or beam tetrode audio-frequency power output stage.

plifier stage. Tubes of this type have largely replaced triodes in the output stage of receivers and amplifiers due to the higher plate efficiency (30%–40%) with which they operate. Tetrode and pentode tubes do, however, introduce a considerably greater amount of harmonic distortion in their output circuit, particularly odd harmonics. In addition, their plate circuit impedance (which acts in an amplifier to damp loudspeaker overshoot and ringing, and acts in a driver stage to provide good regulation) is many times higher than that of an equivalent triode. The application of negative feedback acts both to reduce distortion and to reduce the effective plate circuit impedance of these tubes.

Operating Characteristics of a Pentode Power Amplifier

The operating characteristics of pentode power amplifiers may be obtained from the plate family of curves, much as in the manner applied to triode tubes. A typical family of pentode plate curves is shown in figure 20. It can be seen from these curves that the plate current of the tube is relatively independent of the applied plate voltage, but is sensitive to screen voltage. In general, the correct pentode load resistance is about

$$\frac{0.9 E_p}{I_p}$$

and the power output is somewhat less than

$$\frac{E_p \times I_p}{2}$$

These formulae may be used for a quick check on more precise calculations. To obtain the operating parameters for Class A pentode amplifiers, the following steps are taken:

- 1- The i_{max} point is chosen so as to fall on the zero-bias curve, just above the "knee" of the curve (point A, figure 20).
- 2- A preliminary operating point, P, is determined by the intersection of the plate voltage line, E_p , and the line of $i_{max}/2$.

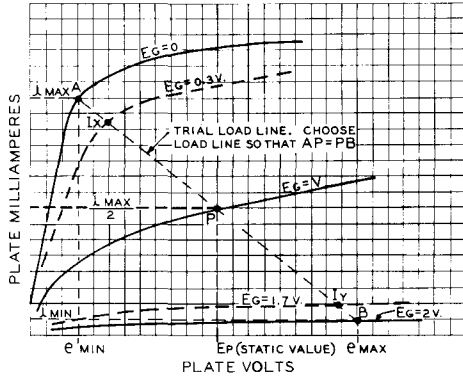

Figure 20
GRAPHIC DETERMINATION OF OPERATING CHARACTERISTICS OF A PENTODE POWER AMPLIFIER

"V" is the negative control grid voltage at the operating point P

The grid voltage curve that this point falls upon should be one that is about 1/2 the value of E_g required to cut the plate current to a very low value (Point B). Point B represents i_{min} on the plate current axis (y-axis). The line $i_{max}/2$ should be located half-way between i_{max} and i_{min} .

- 3- A trial load line is constructed about point P and point A in such a way that the lengths A-P and P-B are approximately equal.
- 4- When the most satisfactory load line has been determined, the load resistance may be calculated:

$$R_L = \frac{e_{max} - e_{min}}{i_{max} - i_{min}}$$

- 5- The operating bias (E_g) is the bias at point P.

- 6- The power output is:

Power Output (watts)

$$P_o = \frac{(i_{max} - i_{min}) + 1.41 (I_x - I_y)^2 \times R_L}{32}$$

Where I_x is the plate current at the point on the load line where the grid voltage, e_g , is equal to: $E_g - 0.7 E_g$; and where I_y is the plate current at the point where e_g is equal to: $E_g + 0.7 E_g$.

- 7- The percentage harmonic distortion is:

% 2d harmonic distortion

$$= \frac{i_{max} - i_{min} - 2 I_p}{i_{max} - i_{min} + 1.41 (I_x - I_y)} \times 100$$

Where I_p is the static plate current of the tube.

% 3d harmonic distortion

$$= \frac{i_{max} - i_{min} - 1.41 (I_x - I_y)}{i_{max} - i_{min} + 1.41 (I_x - I_y)} \times 100$$

6-12 Push-Pull Audio Amplifiers

A number of advantages are obtained through the use of the push-pull connection of two or four tubes in an audio-frequency power amplifier. Two conventional circuits for the use of triode and tetrode tubes in the push-pull connection are shown in figure 21. The two main advantages of the push-pull circuit arrangement are: (1) the magnetizing effect of the plate currents of the output tubes is cancelled in the windings of the output transformer; (2) even harmonics of the input signal (second and fourth harmonics primarily) generated in the push-pull stage are cancelled when the tubes are balanced.

The cancellation of even harmonics generated in the stage allows the tubes to be oper-

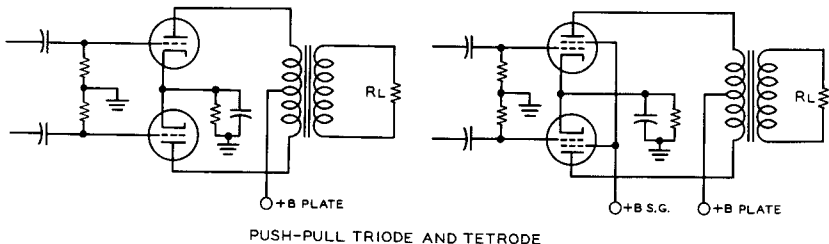

FIGURE 21

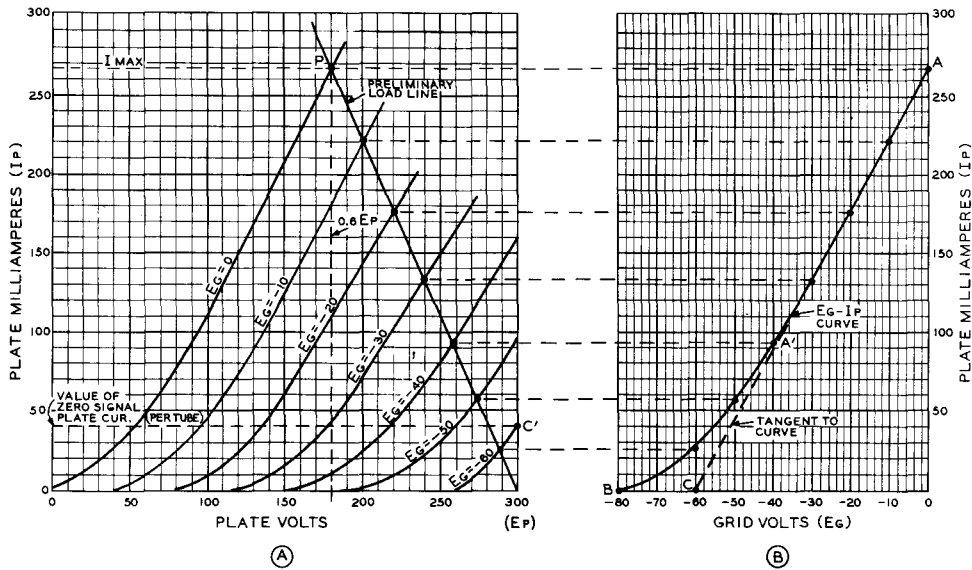

Figure 22
 DETERMINATION OF OPERATING PARAMETERS FOR PUSH-PULL CLASS A TRIODE TUBES

ated Class AB — in other words the tubes may be operated with bias and input signals of such amplitude that the plate current of alternate tubes may be cut off during a portion of the input voltage cycle. If a tube were operated in such a manner in a single-ended amplifier the second harmonic amplitude generated would be prohibitively high.

Push-pull Class AB operation allows a plate circuit efficiency of from 45 to 60 per cent to be obtained in an amplifier stage depending upon whether or not the exciting voltage is of such amplitude that grid current is drawn by the tubes. If grid current is taken on input voltage peaks the amplifier is said to be operating Class AB₂ and the plate circuit efficiency can be as high as the upper value just mentioned. If grid current is not taken by the stage it is said to be operating Class AB₁ and the plate circuit efficiency will be toward the lower end of the range just quoted. In all Class AB amplifiers the plate current will increase from 40 to 150 per cent over the no-signal value when full signal is applied.

Operating Characteristics of Push-Pull Class A Triode Power Amplifier

The operating characteristics of push-pull Class A amplifiers may also be determined from the plate family of curves for

a particular triode tube by the following steps:

- 1- Erect a vertical line from the plate voltage axis (x-axis) at $0.6 E_p$ (figure 22), which intersects the $E_g = 0$ curve. This point of intersection (P), interpolated to the plate current axis (y-axis) may be taken as i_{max} . It is assumed for simplification that i_{max} occurs at the point of the zero-bias curve corresponding to $0.6 E_p$.
- 2- The power output obtainable from the two tubes is:

$$\text{Power output } (P_o) = \frac{i_{max} \times E_p}{5}$$

where P_o is expressed in watts, i_{max} in amperes, and E_p is the applied plate voltage.

- 3- Draw a preliminary load line through point P to the E_p point located on the x-axis (the zero plate current line). This load line represents $1/4$ of the actual plate-to-plate load of the Class A tubes. Therefore:

$$R_L \text{ (plate-to-plate)} = 4 \times \frac{E_p - 0.6 E_p}{i_{max}} = \frac{1.6 E_p}{i_{max}}$$

determined from the plate family of curves for

where R_L is expressed in ohms, E_p in volts, and i_{max} in amperes.

Figure 22 illustrates the above steps applied to a push-pull Class A amplifier using two 2A3 tubes.

- 4- The average plate current is $0.636 i_{max}$, and, multiplied by the plate voltage, E_p , will give the average watts input to the plates of the two tubes. The power output should be subtracted from this value to obtain the total operating plate dissipation of the two tubes. If the plate dissipation is excessive, a slightly higher value of R_L should be chosen to limit the plate dissipation.
- 5- The correct value of operating bias, and the static plate current for the push-pull tubes may be determined from the E_g vs. I_p curves, which are a derivation of the E_p vs. I_p curves for various values of E_g .
- 6- The E_g vs. I_p curve may be constructed in this manner: Values of grid bias are read from the intersection of each grid bias curve with the load line. These points are transferred to the E_g vs. I_p graph to produce a curved line, A-B. If the grid bias curves of the E_p vs. I_p graph were straight lines, the lines of the E_g vs. I_p graph would also be straight. This is usually not the case. A tangent to this curve is therefore drawn, starting at point A', and intersecting the grid voltage abscissa (x-axis). This intersection (C) is the operating bias point for fixed bias operation.
- 7- This operating bias point may now be plotted on the original E_g vs. I_p family of curves (C'), and the zero-signal current produced by this bias is determined. This operating bias point (C') does not fall on the operating load line, as in the case of a single-ended amplifier.
- 8- Under conditions of maximum power output, the exciting signal voltage swings from zero-bias voltage to zero-bias voltage for each of the tubes on each half of the signal cycle. Second harmonic distortion is largely cancelled out.

6-13 Class B Audio Frequency Power Amplifiers

The Class B audio-frequency power amplifier (figure 23) operates at a higher plate-circuit efficiency than any of the previously described types of audio power amplifiers. Full-signal plate-circuit efficiencies of 60 to

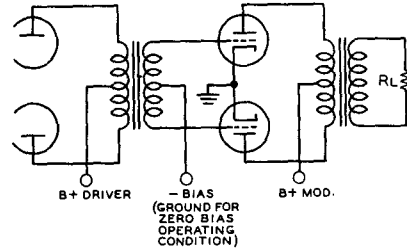

Figure 23
CLASS B AUDIO FREQUENCY
POWER AMPLIFIER

70 per cent are readily obtainable with the tube types at present available for this type of work. Since the plate circuit efficiency is higher, smaller tubes of lower plate dissipation may be used in a Class B power amplifier of a given power output than can be used in any other conventional type of audio amplifier. An additional factor in favor of the Class B audio amplifier is the fact that the power input to the stage is relatively low under no-signal conditions. It is for these reasons that this type of amplifier has largely superseded other types in the generation of audio-frequency levels from perhaps 100 watts on up to levels of approximately 150,000 watts as required for large short-wave broadcast stations.

Disadvantages of Class B Amplifier Operation There are attendant disadvantageous features to the operation of a power amplifier of this type; but all these disadvantages can be overcome by proper design of the circuits associated with the power amplifier stage. These disadvantages are: (1) The Class B audio amplifier requires driving power in its grid circuit; this disadvantage can be overcome by the use of an oversize power stage preceding the Class B stage with a step-down transformer between the driver stage and the Class-B grids. Degenerative feedback is sometimes employed to reduce the plate impedance of the driver stage and thus to improve the voltage regulation under the varying load presented by the Class B grids. (2) The Class B stage requires a constant value of average grid bias to be supplied in spite of the fact that the grid current on the stage is zero over most of the cycle but rises to values as high as one-third of the peak plate current on the peak of the exciting voltage cycle. Special regulated bias supplies have been used for this application, or B batteries can be used. However, a number

of tubes especially designed for Class B audio amplifiers have been developed which require zero average grid bias for their operation. The 811A, 838, 805, 809, HY-5514, and TZ-40 are examples of this type of tube. All these so-called "zero-bias" tubes have rated operating conditions up to moderate plate voltages wherein they can be operated without grid bias. As the plate voltage is increased to to their maximum ratings, however, a small amount of grid bias, such as could be obtained from several 4 1/2-volt C batteries, is required.

(3), A Class B audio-frequency power amplifier or modulator requires a source of plate supply voltage having reasonably good regulation. This requirement led to the development of the *swinging choke*. The swinging choke is essentially a conventional filter choke in which the core air gap has been reduced. This reduction in the air gap allows the choke to have a much greater value of inductance with low current values such as are encountered with no signal or small signal being applied to the Class B stage. With a higher value of current such as would be taken by a Class B stage with full signal applied the inductance of the choke drops to a much lower value. With a swinging choke of this type, having adequate current rating, as the input inductor in the filter system for a rectifier power supply, the regulation will be improved to a point which is normally adequate for a power supply for a Class B amplifier or modulator stage.

Calculation of Operating Conditions of Class B Power Amplifiers

The following procedure can be used for the calculation of the operating conditions of Class B power amplifiers when they are to operate into a resistive load such as the type of load presented by a Class C power amplifier. This procedure will be found quite satisfactory for the application of vacuum tubes as Class B modulators when it is desired to operate the tubes under conditions which are not specified in the tube operating characteristics published by the tube manufacturer. The same procedure can be used with equal effectiveness for the calculation of the operating conditions of beam tetrodes as Class AB₂ amplifiers or modulators when the resting plate current on the tubes (no signal condition) is less than 25 or 30 per cent of the maximum-signal plate current.

- 1- With the average plate characteristics of the tube as published by the manufacturer before you, select a point on the $E_p = E_g$ (diode bend) line at about twice the plate current you expect the tubes to kick to under modulation. If beam tetrode tubes are concerned, select

a point at about the same amount of plate current mentioned above, just to the right of the region where the I_b line takes a sharp curve downward. This will be the first trial point, and the plate voltage at the point chosen should be not more than about 20 per cent of the d-c voltage applied to the tubes if good plate-circuit efficiency is desired.

- 2- Note down the value of i_{pmax} and e_{pmin} at this point.
- 3- Subtract the value of e_{pmin} from the d-c plate voltage on the tubes.
- 4- Substitute the values obtained in the following equations:

$$P_o = \frac{i_{pmax}(E_{bb} - e_{pmin})}{2} = \text{Power output from 2 tubes}$$

$$R_L = 4 \frac{(E_{bb} - e_{pmin})}{i_{pmax}} = \text{Plate-to-plate load for 2 tubes}$$

Full signal efficiency (N_p) =

$$78.5 \left(1 - \frac{e_{pmin}}{E_{bb}} \right)$$

Effects of Speech Clipping All the above equations are true for sine-wave operating conditions of the tubes concerned. However, if a speech clipper is being used in the speech amplifier, or if it is desired to calculate the operating conditions on the basis of the fact that the ratio of peak power to average power in a speech wave is approximately 4-to-1 as contrasted to the ratio of 2-to-1 in a sine wave — in other words, when non-sinusoidal waves such as plain speech or speech that has passed through a clipper are concerned, we are no longer concerned with average power output of the modulator as far as its capability of modulating a Class-C amplifier is concerned; we are concerned with its *peak-power-output* capability.

Under these conditions we call upon other, more general relationships. The first of these is: It requires a *peak* power output *equal* to the Class-C stage input to modulate that input fully.

The second one is: The average power output required of the modulator is equal to the shape factor of the modulating wave multiplied by the input to the Class-C stage. The shape factor of unclipped speech is approximately 0.25. The shape factor of a sine wave is 0.5. The shape factor of a speech wave that

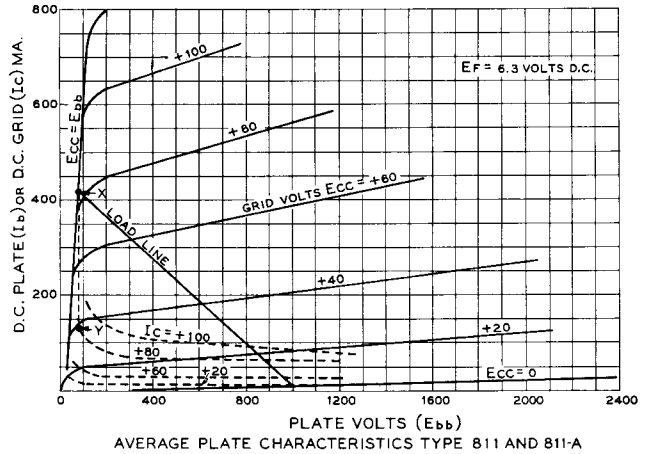

Figure 24
 Typical Class B a-f amplifier load line. The load line has been drawn on the average characteristics of a type 811 tube.

has been passed through a clipper-filter arrangement is somewhere between 0.25 and 0.9 depending upon the amount of clipping that has taken place. With 15 or 20 db of clipping the shape factor may be as high as the figure of 0.9 mentioned above. This means that the audio power output of the modulator will be 90% of the input to the Class-C stage. Thus with a kilowatt input we would be putting 900 watts of audio into the Class-C stage for 100 per cent modulation as contrasted to perhaps 250 watts for unclipped speech modulation of 100 per cent.

Sample Calculation Figure 24 shows a set of plate characteristics for a type 811A tube with a load line for Class B operation. Figure 25 lists a sample calculation for determining the proper operating conditions for obtaining approximately 185 watts output from a pair of the tubes with 1000 volts d-c plate potential. Also shown in figure 25 is the method of determining the proper ratio for the modulation transformer to couple between the 811's or 811A's and the anticipated final amplifier which is to operate at 2000 plate volts and 175 ma. plate current.

Modulation Transformer Calculation The method illustrated in figure 25 can be used in general for the determination of the proper transformer ratio to couple between the modulator tube and the amplifier to be modulated. The procedure can be stated as follows: (1) Determine the proper plate-to-plate load impedance for the modulator tubes either by the use of the type of calcula-

tion shown in figure 25, or by reference to the published characteristics on the tubes to be used. (2) Determine the load impedance which will be presented by the Class C amplifier stage to be modulated by dividing the operating plate voltage on that stage by the operating value of plate current in amperes. (3) Divide the Class C load impedance determined in (2)

SAMPLE CALCULATION

CONDITION: 2 TYPE 811 TUBES, $E_{bb} = 1000$
 INPUT TO FINAL STAGE, 350 W.
 PEAK POWER OUTPUT NEEDED = $350 + 6\% = 370$ W.
 FINAL AMPLIFIER $E_{bb} = 2000$ V.
 FINAL AMPLIFIER $I_b = .175$ A.
 FINAL AMPLIFIER $Z_L = \frac{2000}{.175} = 11400 \Omega$

EXAMPLE: CHOSE POINT ON 811 CHARACTERISTICS JUST TO RIGHT OF $E_{bb} = ECC$. (POINT X, FIG. 24)
 IP MAX. = .410 A. EP MIN. = +100
 IG MAX. = .100 A. EG MAX. = +80

PEAK $P_o = .410 \times (1000 - 100) = .410 \times 900 = 369$ W.
 $R_L = 4 \times \frac{900}{.410} = 8800 \Omega$
 $NP = 78.5 (1 - \frac{100}{1000}) = 78.5 (.9) = 70.5 \%$
 W_o (AVERAGE WITH SINE WAVE) = $\frac{PO(PEAK)}{2} = 184.5$ W
 $WIN = \frac{184.5}{70.5} = 260$ W.
 I_b (MAXIMUM WITH SINE WAVE) = 260 MA
 $WG_{PEAK} = .100 \times 80 = 8$ W.
 DRIVING POWER = $\frac{WG_{PK}}{2} = 4$ W.

TRANSFORMER:
 $\frac{Z_s}{Z_p} = \frac{11400}{8800} = 1.29$
 TURNS RATIO = $\sqrt{\frac{Z_s}{Z_p}} = \sqrt{1.29} = 1.14$ STEP UP

Figure 25

Typical calculation of operating conditions for a Class B a-f power amplifier using a pair of type 811 or 811A tubes. Plate characteristics and load line shown in figure 24.

above by the plate-to-plate load impedance for the modulator tubes determined in (1) above. The ratio determined in this way is the secondary-to-primary *impedance* ratio. (4) Take the square root of this ratio to determine the secondary-to-primary *turns* ratio. If the turns ratio is greater than one the use of a step-up transformer is required. If the turns ratio as determined in this way is less than one a step-down transformer is called for.

If the procedure shown in figure 25 has been used to calculate the operating conditions for the modulator tubes, the transformer ratio calculation can be checked in the following manner: Divide the plate voltage on the modulated amplifier by the total voltage swing on the modulator tubes: $2(E_{bb} - e_{min})$. This ratio should be quite close numerically to the transformer turns ratio as previously determined. The reason for this condition is that the ratio between the total primary voltage and the d-c plate supply voltage on the modulated stage is equal to the turns ratio of the transformer, since a peak secondary voltage equal to the plate voltage on the modulated stage is required to modulate this stage 100 per cent.

Use of Clipper Speech Amplifier with Tetrode Modulator Tubes When a clipper speech amplifier is used in conjunction with a Class

B modulator stage, the plate current on that stage will kick to a higher value with modulation (due to the greater average power output and input) but the plate dissipation on the tubes will ordinarily be less than with sine-wave modulation. However, when tetrode tubes are used as modulators, the screen dissipation will be much greater than with sine-wave modulation. Care must be taken to insure that the screen dissipation rating on the modulator tubes is not exceeded under full modulation conditions with a clipper speech amplifier. The screen dissipation is equal to screen voltage times screen current.

Practical Aspects of Class B Modulators As stated previously, a Class B audio amplifier

requires the driving stage to supply well-regulated audio power to the grid circuit of the Class B stage. Since the performance of a Class B modulator may easily be impaired by an improperly designed driver stage, it is well to study the problems incurred in the design of the driver stage.

The grid circuit of a Class B modulator may be compared to a variable resistance which decreases in value as the exciting grid voltage is increased. This variable resistance appears across the secondary terminals of the driver transformer so that the driver stage is

called upon to deliver power to a varying load. For best operation of the Class B stage, the grid excitation voltage should not drop as the power taken by the grid circuit increases. These opposing conditions call for a high order of voltage regulation in the driver stage plate circuit. In order to enhance the voltage regulation of this circuit, the driver tubes must have low plate resistance, the driver transformer must have as large a step-down ratio as possible, and the d-c resistance of both primary and secondary windings of the driver transformer should be low.

The driver transformer should reflect into the plate circuit of the driver tubes a load of such value that the required driving power is just developed with full excitation applied to the driver grid circuit. If this is done, the driver transformer will have as high a step-down ratio as is consistent with the maximum drive requirements of the Class B stage. If the step-down ratio of the driver transformer is too large, the driver plate load will be so high that the power required to drive the Class B stage to full output cannot be developed. If the step-down ratio is too small the regulation of the driver stage will be impaired.

Driver Stage Calculations The parameters for the driver stage may be calculated from the plate characteristic curve, a sample of which is shown in figure 24. The required positive grid voltage (e_{g-max}) for the 811A tubes used in the sample calculation is found at point X, the intersection of the load line and the peak plate current as found on the y-axis. This is +80 volts. If a vertical line is dropped from point X to intersect the dotted grid current curves, it will be found that the grid current for a single 811A at this value of grid voltage is 100 milliamperes (point Y). The peak grid driving power is therefore $80 \times 0.100 = 8$ watts. The approximate *average* driving power is 4 watts. This is an approximate figure because the grid impedance is not constant over the entire audio cycle.

A pair of 2A3 tubes will be used as drivers, operating Class A, with the maximum excitation to the drivers occurring just below the point of grid current flow in the 2A3 tubes. The driver plate voltage is 300 volts, and the grid bias is -62 volts. The peak power developed in the primary winding of the driver transformer is:

$$\text{Peak Power (P}_p\text{)} = 2R_L \left(\frac{\mu E_g}{R_p + R_L} \right)^2$$

(watts)

where μ is the amplification factor of the driver tubes (4.2 for 2A3). E_g is the peak grid swing of the driver stage (62 volts). R_p is the

plate resistance of one driver tube (800 ohms). R_L is $\frac{1}{2}$ the plate-to-plate load of the driver stage, and P_p is 8 watts.

Solving the above equation for R_L , we obtain a value of 14,500 ohms load, plate-to-plate for the 2A3 driver tubes.

The peak primary voltage is:

$$e_{pri} = 2R_L \times \frac{\mu E_g}{R_p + R_L} = 493 \text{ volts}$$

and the turns ratio of the driver transformer (primary to $\frac{1}{2}$ secondary) is:

$$\frac{e_{pri}}{e_{g(max)}} = \frac{493}{80} = 6.15:1$$

Plate Circuit Impedance Matching One of the commonest causes of distortion in a Class B modulator is incorrect load impedance in the plate circuit. The purpose of the Class B modulation transformer is to take the power developed by the modulator (which has a certain operating impedance) and transform it to the operating impedance imposed by the modulated amplifier stage.

If the transformer in question has the same number of turns on the primary winding as it has on the secondary winding, the turns ratio is 1:1, and the impedance ratio is also 1:1. If a 10,000 ohm resistor is placed across the secondary terminals of the transformer, a *reflected load* of 10,000 ohms would appear across the primary terminals. If the resistor is changed to one of 2376 ohms, the reflected primary impedance would also be 2376 ohms.

If the transformer has twice as many turns on the secondary as on the primary, the turns ratio is 2:1. The impedance ratio is the square of the turns ratio, or 4:1. If a 10,000 ohm resistor is now placed across the secondary winding, a reflected load of 2,500 ohms will appear across the primary winding.

Effects of Plate Circuit Mis-match It can be seen from the above paragraphs that the Class B modulator plate load is entirely dependent upon the load placed upon the secondary terminals of the Class B modulation transformer. If the secondary load is incorrect, certain changes will take place in the operation of the Class B modulator stage.

When the modulator load impedance is too low, the efficiency of the Class B stage is reduced and the plate dissipation of the tubes is increased. Peak plate current of the modulator stage is increased, and saturation of the modulation transformer core may result. "Talk-back" of the modulation trans-

former may result if the plate load impedance of the modulator stage is too low.

When the modulator load impedance is too high, the maximum power capability of the stage is reduced. An attempt to increase the output by increasing grid excitation to the stage will result in peak-clipping of the audio wave. In addition, high peak voltages may be built up in the plate circuit that may damage the modulation transformer.

6-14 Cathode-Follower Power Amplifiers

The cathode-follower is essentially a power output stage in which the exciting signal is applied between grid and ground. The plate is maintained at ground potential with respect to input and output signals, and the output signal is taken between cathode and ground.

Types of Cathode-Follower Amplifiers Figure 26 illustrates four types of cathode-follower power amplifiers in common usage and figure 27 shows the output impedance (R_o), and stage gain (A) of both triode and pentode (or tetrode) cathode-follower stages. It will be seen by inspection of the equations that the stage voltage gain is always less than one, that the output impedance of the stage is much less than the same stage operated as a conventional cathode-return amplifier. The output impedance for conventional tubes will be somewhere between 100 and 1000 ohms, depending primarily on the transconductance of the tube.

This reduction in gain and output impedance for the cathode-follower comes about since the stage operates as though it has 100 per cent degenerative feedback applied between its output and input circuit. Even though the voltage gain of the stage is reduced to a value less than one by the action of the degenerative feedback, the power gain of the stage (if it is operating Class A) is not reduced. Although more voltage is required to excite a cathode-follower amplifier than appears across the load circuit, since the cathode "follows" along with the grid, the relative grid-to-cathode voltage is essentially the same as in a conventional amplifier.

Use of Cathode-Follower Amplifiers Although the cathode-follower gives no voltage gain, it is an effective power amplifier where it is desired to feed a low-impedance load, or where it is desired to feed a load of varying impedance with a signal having good regulation. This latter capability

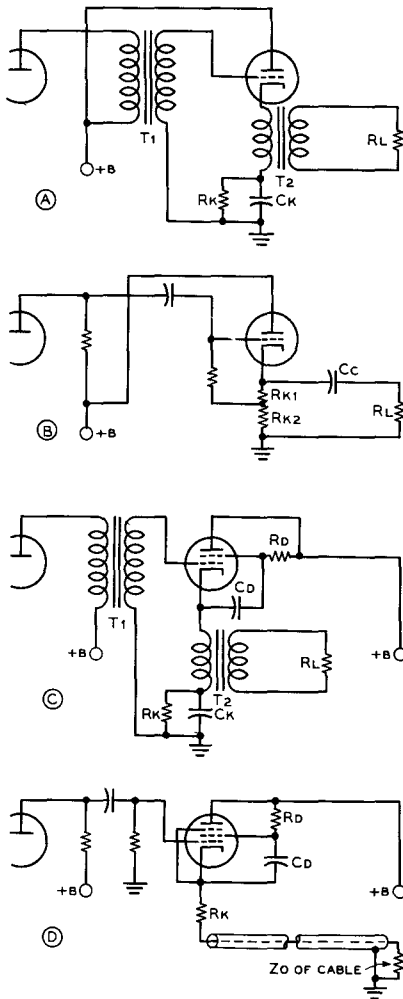

Figure 26
CATHODE-FOLLOWER OUTPUT
CIRCUITS FOR AUDIO OR
VIDEO AMPLIFIERS

makes the cathode follower particularly effective as a driver for the grids of a Class B modulator stage.

The circuit of figure 26A is the type of amplifier, either single-ended or push-pull, which may be used as a driver for a Class B modulator or which may be used for other applications such as feeding a loudspeaker where unusually good damping of the speaker is desired. If the d-c resistance of the primary of the transformer T_2 is approximately the correct value for the cathode bias resistor for the am-

TRIODE: $\mu_{CF} = \frac{\mu}{\mu + 1}$ $A = \frac{\mu R_L}{R_L(\mu + 1) + R_p}$

$R_{O(CATHODE)} = \frac{R_p}{\mu + 1}$ $R_L = \frac{(R_{K1} + R_{K2}) R_L'}{R_{K1} + R_{K2} + R_L'}$

PENTODE: $R_{O(CATHODE)} = \frac{1}{G_m}$ $R_{eq} = \frac{R_L}{1 + R_L G_m}$

$A = G_m R_{eq}$

Figure 27
Equivalent factors for pentode (or tetrode)
cathode-follower power amplifiers.

plifier tube, the components R_k and C_k need not be used. Figure 26B shows an arrangement which may be used to feed directly a value of load impedance which is equal to or higher than the cathode impedance of the amplifier tube. The value of C_c must be quite high, somewhat higher than would be used in a conventional circuit, if the frequency response of the circuit when operating into a low-impedance load is to be preserved.

Figures 26C and 26D show cathode-follower circuits for use with tetrode or pentode tubes. Figure 26C is a circuit similar to that shown in 26A and essentially the same comments apply in regard to the components R_k and C_k and the primary resistance of the transformer T_2 . Notice also that the screen of the tube is maintained at the same signal potential as the cathode by means of coupling capacitor C_d . This capacitance should be large enough so that at the lowest frequency it is desired to pass through the stage its reactance will be low with respect to the dynamic screen-to-cathode resistance in parallel with R_d . T_2 in this stage as well as in the circuit of figure 26A should have the proper turns (or impedance) ratio to give the desired step-down or step-up from the cathode circuit to the load. Figure 26D is an arrangement frequently used in video systems for feeding a coaxial cable of relatively low impedance from a vacuum-tube amplifier. A pentode or tetrode tube with a cathode impedance as a cathode follower ($1/G_m$) approximately the same as the cable impedance should be chosen. The 6AG7 and 6AC7 have cathode impedances of the same order as the surge impedances of certain types of low-capacitance coaxial cable. An arrangement such as 26D is also usable for feeding coaxial cable with audio or r-f energy where it is desired to transmit the output signal over moderate distances. The resistor R_k is added to the circuit as shown if the cathode impedance of the tube used is lower than the

characteristic impedance of the cable. If the output impedance of the stage is higher than the cable impedance a resistance of appropriate value is sometimes placed in parallel with the input end of the cable. The values of C_d and R_d should be chosen with the same considerations in mind as mentioned in the discussion of the circuit of figure 26C above.

The Cathode-Follower in R-F Stages The cathode follower may conveniently be used as a method of coupling r-f or i-f energy between two units separated a considerable distance. In such an application a coaxial cable should be used to carry the r-f or i-f energy. One such application would be for carrying the output of a v-f-o to a transmitter located a considerable distance from the operating position. Another application would be where it is desired to feed a single-sideband demodulator, an FM adaptor, or another accessory with intermediate frequency signal from a communications receiver. A tube such as a 6CB6 connected in a manner such as is shown in figure 26D would be adequate for the i-f amplifier coupler, while a 6L6 or a 6AG7 could be used in the output stage of a v-f-o as a cathode follower to feed the coaxial line which carries the v-f-o signal from the control unit to the transmitter proper.

6-15 Feedback Amplifiers

It is possible to modify the characteristics of an amplifier by feeding back a portion of the output to the input. All components, circuits and tubes included between the point where the feedback is taken off and the point where the feedback energy is inserted are said to be included within the feedback loop. An amplifier containing a feedback loop is said to be a *feedback amplifier*. One stage or any number of stages may be included within the feedback loop. However, the difficulty of obtaining proper operation of a feedback amplifier increases with the bandwidth of the amplifier, and with the number of stages and circuit elements included within the feedback loop.

Gain and Phase-shift in Feedback Amplifiers The gain and phase shift of any amplifier are functions of frequency. For any amplifier containing a feedback loop to be completely stable the gain of such an amplifier, as measured from the input back to the point where the feedback circuit connects to the input, must be less than one

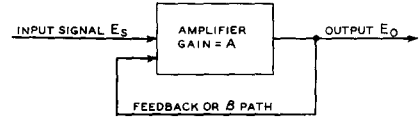

VOLTAGE AMPLIFICATION WITH FEEDBACK = $\frac{A}{1 - A\beta}$

A = GAIN IN ABSENCE OF FEEDBACK

β = FRACTION OF OUTPUT VOLTAGE FED BACK

β IS NEGATIVE FOR NEGATIVE FEEDBACK

FEEDBACK IN DECIBELS = $20 \text{ LOG } (1 - A\beta)$

= $20 \text{ LOG } \frac{\text{MID FREQ. GAIN WITHOUT FEEDBACK}}{\text{MID FREQ. GAIN WITH FEEDBACK}}$

DISTORTION WITH FEEDBACK = $\frac{\text{DISTORTION WITHOUT FEEDBACK}}{(1 - A\beta)}$

$R_o = \frac{R_N}{1 - A\beta (1 + \frac{R_N}{R_L})}$

WHERE:

R_o = OUTPUT IMPEDANCE OF AMPLIFIER WITH FEEDBACK

R_N = OUTPUT IMPEDANCE OF AMPLIFIER WITHOUT FEEDBACK

R_L = LOAD IMPEDANCE INTO WHICH AMPLIFIER OPERATES

Figure 28
FEEDBACK AMPLIFIER RELATIONSHIPS

at the frequency where the feedback voltage is in phase with the input voltage of the amplifier. If the gain is equal to or more than one at the frequency where the feedback voltage is in phase with the input the amplifier will oscillate. This fact imposes a limitation upon the amount of feedback which may be employed in an amplifier which is to remain stable. If the reader is desirous of designing amplifiers in which a large amount of feedback is to be employed he is referred to a book on the subject by H. W. Bode.*

Types of Feedback Feedback may be either negative or positive, and the feedback voltage may be proportional either to output voltage or output current. The most commonly used type of feedback with a-f or video amplifiers is negative feedback proportional to output voltage. Figure 28 gives the general operating conditions for feedback amplifiers. Note that the reduction in distortion is proportional to the reduction in gain of the amplifier, also that the reduction in the output impedance of the amplifier is somewhat greater than the reduction in the gain by an amount which is a function of the ratio of the

H. W. Bode, "Network Analysis and Feedback Amplifier Design," D. Van Nostrand Co., 250 Fourth Ave., New York 3, N. Y.

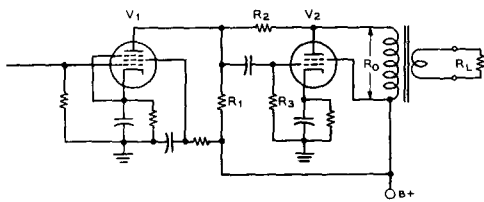

$$\begin{aligned}
 \text{DB FEEDBACK} &= 20 \text{ LOG} \left\{ \frac{R_2 + R_A (G_{M V_2} R_0)}{R_2} \right\} \\
 &= 20 \text{ LOG} \left\{ \frac{R_2 + R_A (\text{VOLTAGE GAIN OF } V_2)}{R_2} \right\} \\
 \text{GAIN OF BOTH STAGES} &= \left\{ G_{M V_1} \left(\frac{R_N \times R_A}{R_B + R_A} \right) \right\} \times (G_{M V_2} R_0) \\
 \text{WHERE:} \\
 R_A &= \frac{R_1 \times R_3}{R_1 + R_3} \\
 R_B &= \frac{R_2}{G_{M V_2} R_0} \\
 R_0 &= \text{REFLECTED LOAD IMPEDANCE ON } V_2 \\
 R_2 &= \text{FEEDBACK RESISTOR (USUALLY ABOUT 500 K)} \\
 \text{OUTPUT IMPEDANCE} &= \frac{R_N R_2}{(R_2 + R_A (G_{M V_2} R_0))} \times \left(1 + \frac{R_N}{R_0} \right) \\
 R_N &= \text{PLATE IMPEDANCE OF } V_2
 \end{aligned}$$

Figure 29
SHUNT FEEDBACK CIRCUIT FOR PENTODES OR TETRODES

This circuit requires only the addition of one resistor, R₂, to the normal circuit for such an application. The plate impedance and distortion introduced by the output stage are materially reduced.

output impedance of the amplifier without feedback to the load impedance. The reduction in noise and hum in those stages included within the feedback loop is proportional to the reduction in gain. However, due to the reduction in gain of the output section of the amplifier somewhat increased gain is required of the stages preceding the stages included within the feedback loop. Therefore the noise and hum output of the entire amplifier may or may not be reduced dependent upon the relative contributions of the first part and the latter part of the amplifier to hum and noise. If most of the noise and hum is coming from the stages included within the feedback loop the undesired signals will be reduced in the output from the complete amplifier. It is most frequently true in conventional amplifiers that the hum and distortion come from the latter stages, hence these will be reduced by feedback, but thermal agitation and microphonic noise come from the first stage and will not be reduced but may be increased by feedback unless the feedback loop includes the first stage of the amplifier.

Figure 29 illustrates a very simple and effective application of negative voltage feedback to an output pentode or tetrode amplifier stage. The reduction in hum and distortion may amount to 15 to 20 db. The reduction in the effective plate impedance of the stage will be by a factor of 20 to 100 dependent upon the operating conditions. The circuit is commonly used in commercial equipment with tubes such as the 6SJ7 for V₁ and the 6V6 or 6L6 for V₂.

6-16 Vacuum-Tube Voltmeters

The *vacuum-tube voltmeter* may be considered to be a vacuum-tube detector in which the rectified d-c current is used as an indication of the magnitude of the applied alternating voltage. The vacuum tube voltmeter (v.t.v.m.) consumes little or no power and it may be calibrated at 60 cycles and used at audio or radio frequencies with little change in the calibration.

Basic D-C Vacuum-Tube Voltmeter

A simple v.t.v.m. is shown in figure 30.

The plate load may be a mechanical device, such as a relay or a meter, or the output voltage may be developed across a resistor and used for various control purposes. The tube is biased by E_c and a fixed value of plate current flows, causing a fixed voltage drop across the plate load resistor, R_p. When a positive d-c voltage is applied to the input terminals it cancels part of the negative grid bias, making the grid more positive with respect to the cathode. This grid voltage change permits a greater amount of plate current to flow, and develops a greater voltage drop across the plate load resistor. A negative input voltage would decrease the plate current and decrease the voltage drop across R_p. The varying voltage drop across R_p may be employed as a control voltage for relays or other devices. When it is desired to measure various voltages, a voltage

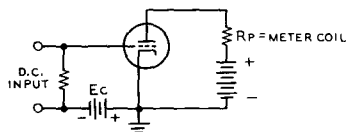

Figure 30
SIMPLE VACUUM TUBE VOLTMMETER

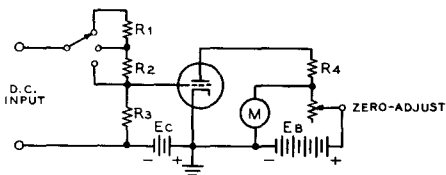

Figure 31
D-C VACUUM TUBE VOLTMETER

range switch (figure 31) may precede the v.t.v.m. The voltage to be measured is applied to voltage divider, R_1 , R_2 , R_3 , by means of the "voltage range" switch. Resistor R_4 is used to protect the meter from excessive input voltage to the v.t.v.m. In the plate circuit of the tube an additional battery and a variable resistor ("zero adjustment") are used to balance out the meter reading of the normal plate current of the tube. The zero adjustment potentiometer can be so adjusted that the meter M reads zero current with no input voltage to the v.t.v.m. When a d-c input voltage is applied to the circuit, current flows through the meter, and the meter reading is proportional to the applied d-c voltage.

The Bridge-type V.T.V.M.

Another important use of a d-c amplifier is to show the exact point of balance between two d-c voltages. This is done by means of a bridge circuit with two d-c amplifiers serving as two legs of the bridge (figure 32). With no input signal, and with matched triodes, no current will be read on meter M , since the IR drops across R_1 and R_2 are identical. When a signal is applied to one tube, the IR drops in the plate circuits become unbalanced, and meter M indicates the unbalance. In the same way, two d-c voltages may be compared if they are applied to the two input circuits. When the voltages are equal, the bridge is balanced and no current flows through the meter. If one voltage changes, the bridge becomes unbalanced and indication of this will be noted by a reading of the meter.

A Modern VTVM

For the purpose of analysis, the operation of a modern v.t.v.m. will be described. The *Heathkit V-7A* is a fit instrument for such a description, since it is able to measure positive or negative d-c potentials, a-c r-m-s values, peak-to-peak values, and resistance. The circuit of this unit is shown in figure 33. A sensitive 200 d-c

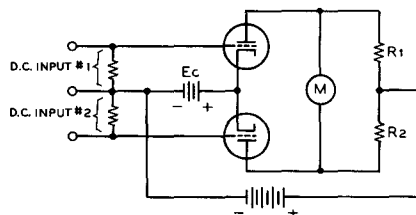

Figure 32
BRIDGE-TYPE VACUUM TUBE VOLTMETER

microammeter is placed in the cathode circuit of a 12AU7 twin triode. The *zero adjust* control sets up a balance between the two sections of the triode such that with zero input voltage applied to the first grid, the voltage drop across each portion of the zero adjust control is the same. Under this condition of balance the meter will read zero. When a voltage is applied to the first grid, the balance in the cathode circuits is upset and the meter indicates the degree of unbalance. The relationship between the applied voltage on the first grid and the meter current is linear and therefore the meter can be calibrated with a linear scale. Since the tube is limited in the amount of current it can draw, the meter movement is electronically protected.

The maximum test voltage applied to the 12AU7 tube is about 3 volts. Higher applied voltages are reduced by a voltage divider which has a total resistance of about 10 megohms. An additional resistance of 1-megohm is located in the d-c test prod, thereby permitting measurements to be made in high impedance circuits with minimum disturbance.

The rectifier portion of the v.t.v.m. is shown in figure 34. When a-c measurements are desired, a 6AL5 double diode is used as a full wave rectifier to provide a d-c voltage proportional to the applied a-c voltage. This d-c voltage is applied through the voltage divider string to the 12AU7 tube causing the meter to indicate in the manner previously described. The a-c voltage scales of the meter are calibrated in both RMS and peak-to-peak values. In the 1.5, 5, 15, 50, and 150 volt positions of the range switch, the full a-c voltage being measured is applied to the input of the 6AL5 full wave rectifier. On the 500 and 1500 volt positions of the range switch, a divider network reduces the applied voltage in order to limit the voltage input to the 6AL5 to a safe recommended level.

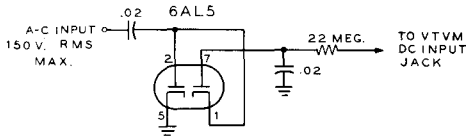

Figure 34
FULL-WAVE RECTIFIER
FOR V.T.V.M.

The *a-c calibrate* control (figure 33) is used to obtain the proper meter deflection for the applied a-c voltage. Vacuum tubes develop a *contact potential* between tube elements. Such contact potential developed in the diode would cause a slight voltage to be present at all times. This voltage is cancelled out by proper application of a bucking voltage. The amount of bucking voltage is controlled by the *a-c balance* control. This eliminates zero shift of the meter when switching from a-c to d-c readings.

For resistance measurements, a 1.5 volt battery is connected through a string of multipliers and the external resistance to be measured, thus forming a voltage divider across the battery, and a resultant portion of the battery voltage is applied to the 12AU7 twin

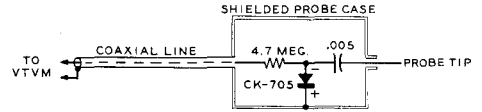

Figure 35
R-F PROBE SUITABLE
FOR USE IN IKC-100 MC
RANGE

triode. The meter scale is calibrated in resistance (ohms) for this function.

Test Probes

Auxiliary *test probes* may be used with the v.t.v.m. to extend the operating range, or to measure radio frequencies with high accuracy. Shown in figure 35 is a radio frequency probe which provides linear response to over 100 megacycles. A crystal diode is used as a rectifier, and d-c isolation is provided by a .005 uufd capacitor. The components of the detector are mounted within a shield at the end of a length of coaxial line, which terminates in the *d-c input* jack of the v.t.v.m. The readings obtained are RMS, and should be multiplied by 1.414 to convert to peak readings.

High Fidelity Techniques

The art and science of the reproduction of sound has steadily advanced, following the major audio developments of the last decade. Public acceptance of home music reproduction on a "high fidelity" basis probably dates from the summer of 1948 when the *Columbia L-P* microgroove recording techniques were introduced.

The term *high fidelity* refers to the reproduction of sound in which the different distortions of the electronic system are held below limits which are audible to the *majority* of listeners. The actual determination, therefore, of the degree of fidelity of a music system is largely psychological as it is dependent upon the ear and temperament of the listener. By and large, a rough area of agreement exists as to what boundaries establish a "hi-fi" system. To enumerate these boundaries it is first necessary to examine *sound* itself.

7-1 The Nature of Sound

Experiments with a simple tuning fork in the seventeenth century led to the discovery that sound consists of a series of condensations and rarefactions of the air brought about by movement of air molecules. The vibrations of the prongs of the fork are communicated to the surrounding air, which in turn transmits the agitation to the ear drums, with the result that we hear a sound. The vibrating fork produces a sound of extreme regularity, and this regularity is the essence of *music*, as opposed to *noise* which has no such regularity.

As shown in figure 1, the sound wave of the fork has *frequency*, *period*, and *pitch*. The frequency is a measure of the number of vibrations per second of the sound. A fork tuned to produce 261 vibrations per second is tuned to the musical note of *middle-C*. It is of interest to note that any object vibrating, moving, or alternating 261 times per second will produce a sound having the pitch of middle-C. The pitch of a sound is that property which is determined by the frequency of vibration of the source, and not by the source itself. Thus an electric dynamo producing 261 c.p.s. will have a hum-pitch of middle-C, as will a siren, a gasoline engine, or other object having the same period of oscillation.

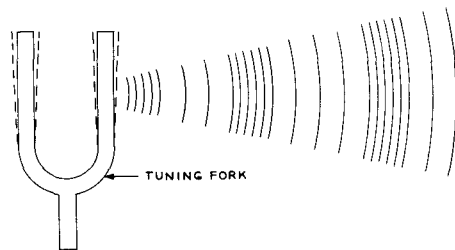

Figure 1
VIBRATION OF TUNING FORK PRODUCES A SERIES OF CONDENSATIONS AND RAREFACTIONS OF AIR MOLECULES. THE DISPLACEMENT OF AIR MOLECULES CHANGES CONTINUALLY WITH RESPECT TO TIME, CREATING A SINE WAVE OF MOTION OF THE DENSITY VARIATIONS.

FREQUENCY (CYCLES PER SECOND)								
NOTE	C	D	E	F	G	A	B	C'
EQUAL-TEMPERED SCALE	261.6	293.7	329.6	349.2	392.0	440.0	493.9	523.2

Figure 2
THE EQUAL-TEMPERED SCALE CONTAINS TWELVE INTERVALS, EACH OF WHICH IS 1.06 TIMES THE FREQUENCY OF THE NEXT LOWEST. THE HALF-TONE INTERVALS INCLUDE THE ABOVE NOTES PLUS FIVE ADDITIONAL NOTES: 277.2, 311.1, 370, 415.3, 466.2 REPRESENTED BY THE BLACK KEYS OF THE PIANO.

The Musical Scale The *musical scale* is composed of notes or sounds of various frequencies that bear a pleasing aural relationship to one another. Certain combinations of notes are harmonious to the ear if their frequencies can be expressed by the simple ratios of 1:2, 2:3, 3:4, and 4:5. Notes differing by a ratio of 1:2 are said to be separated by an *octave*.

The frequency interval represented by an octave is divided into smaller intervals, forming the musical scales. Many types of scales have been proposed and used, but the scale of the piano has dominated western music for the last hundred or so years. Adapted by J. S. Bach, the *equal-tempered scale* (figure 2) has twelve notes, each differing from the next by the ratio 1:1.06. The reference frequency, or *American Standard Pitch* is A, or 440.0 cycles.

Harmonics and Overtones The complex sounds produced by a violin or a wind instrument bear little resemblance to the simple sound wave of the tuning fork. A note of a clarinet, for example (when viewed on an oscilloscope) resembles figure 3. Vocal sounds are even more complex than this. In 1805 Joseph Fourier advanced his monumental theorem that made possible a mathematical analysis of all musical sounds by showing that even the most complex sounds are made up of fundamental vibrations plus *harmonics*, or *overtones*. The tonal qualities of any musical note may be expressed in terms of the amplitude and phase relationship between the overtones of the note.

To produce overtones, the sound source must be vibrating in a complex manner, such as is shown in figure 3. The resulting vibration is a combination of simple vibrations, producing a rich tone having fundamental, the octave tone, and the higher overtones. Any sound —

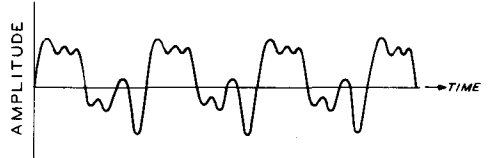

Figure 3
THE COMPLEX SOUND OF A MUSICAL INSTRUMENT IS A COMBINATION OF SIMPLE SINE-WAVE SOUNDS, CALLED HARMONICS. THE SOUND OF LOWEST FREQUENCY IS TERMED THE FUNDAMENTAL. THE COMPLEX VIBRATION OF A CLARINET REED PRODUCES A SOUND SUCH AS SHOWN ABOVE.

no matter how complex — can be analyzed into pure tones, and can be reproduced by a group of sources of pure tones. The number and degree of the various harmonics of a tone and their phase relationship determine the quality of the tone.

For reproduction of the highest quality, these overtones must be faithfully reproduced. A musical note of 523 cycles may be rich in twentieth order overtones. To reproduce the original quality of the note, the audio system must be capable of passing overtone frequencies of the order of 11,000 cycles. Notes of higher fundamental frequency demand that the audio system be capable of good reproduction up to the maximum response limit of the human ear, in the region of 15,000 cycles.

Reproduction Limitations Many factors enter into the problem of high quality audio reproduction. Most important of these factors influence the overall design of the music system. These are:

- 1—Restricted frequency range.
- 2—Nonlinear distortions.
- 3—Transient distortion.
- 4—Nonlinear frequency response.
- 5—Phase distortion.
- 6—Noise, "wow", and "flutter".

A restricted frequency range of reproduction will tend to make the music sound "tinny" and unrealistic. The fundamental frequency range covered by the various musical instruments and the human voice lies between 15 cycles and 9,000 cycles. Overtones of the instruments and the voice extend the upper audible limit of the music range to 15,000 cycles or so. In order to fully reproduce the musical tones falling within this range of frequencies the music system must be capable of flawlessly reproducing *all* frequencies within the range without discrimination.

BASIC LIMITS FOR HIGH FIDELITY AND "GOOD QUALITY" REPRODUCTION		
TYPE OF DISTORTION	LIMIT	
	HIGH FIDELITY	"GOOD" REPRODUCTION
RESTRICTED FREQUENCY RANGE	20-15000 CPS	50-10000 CPS
INTERMODULATION DISTORTION AT FULL OUTPUT	4 %	10 %
HARMONIC DISTORTION AT FULL OUTPUT	2 %	5 %
"WOW"	0.1 %	1 %
HUM AND NOISE	-70 DB BELOW FULL OUTPUT	-50 DB BELOW FULL OUTPUT

Figure 4

Nonlinear qualities such as *harmonic* and *intermodulation* (IM) distortion are extremely objectionable and are created when the output of the music system is not exactly proportional to the input signal. Nonlinearity of any part of the system produces spurious harmonic frequencies, which in turn lead to unwanted beats and resonances. The combination of harmonic frequencies and intermodulation products produce discordant tones which are disagreeable to the ears.

The degree of intermodulation may be measured by applying two tones f_1 and f_2 of known amplitude to the input of the amplifier under test. The relative amplitude of the difference tone ($f_2 - f_1$) is considered a measure of the intermodulation distortion. Values of the order of 4% IM or less define a high fidelity music amplifier.

Response of the music system to rapid transient changes is extremely important. Transient peaks cause overloading and shock-excitation of resonant circuits, leaving a "hang-over" effect that masks the clarity of the sound. A system having poor transient response will not sound natural to the ear, even though the distortion factors are acceptably low.

Linear frequency response and good power handling capability over the complete audio range go hand in hand. The response should be smooth, with no humps or dips in the curve over the entire frequency range. This requirement is particularly important in the electro-mechanical components of the music system, such as the phonograph pickup and the loud-speaker.

Phase distortion is the change of phase angle between the fundamental and harmonic frequencies of a complex tone. The output

wave envelope therefore is different from the envelope of the input wave. In general, phase distortion is difficult to hear in sounds having complex waveforms and may be considered to be sufficiently low in value if the IM figure of the amplifier is acceptable.

Noise and distortions introduced into the program material by the music system must be kept to a minimum as they are particularly noticeable. Record scratch, turntable "rumble", and "flutter" can mar an otherwise high quality system. Inexpensive phonograph motors do not run at constant speed, and the slight variations in speed impart a variation in pitch (*wow*) to the music which can easily be heard. Vibration of the motor may be detected by the pickup arm, superimposing a low frequency rumble on the music.

The various distortions that appear in a music system are summarized in figure 4, together with suggested limits within which the system may truly be termed "high fidelity."

7-2 The Phonograph

The modern phonograph record is a thin disc made of vinylite or shellac material. Disc rotation speeds of 78.3, 33 1/3, and 45 r.p.m. are in use, with the older 78.3 r.p.m. speed gradually being replaced by the lower speeds. A speed of 16 2/3 r.p.m. is used for special "talking book" recordings. A continuous groove is cut in the record by the stylus of the recording machine, spiralling inward towards the center of the record. Amplitude variations in this groove proportional to the sound being recorded constitute the means of placing the intelligence upon the surface of the record. The old 78.3 r.p.m. recordings were cut approximately 100 grooves per inch, while the newer "micro-groove" recordings are cut approximately 250 grooves per inch. Care must be taken to see that the amplitude excursions of one groove do not fall into the adjoining groove. The groove excursions may be controlled by the system of recording, and by equalization of the recording equipment.

Recording Techniques The early commercial phonograph records were cut with a mechanical-acoustic system that produced a *constant velocity* characteristic with the amplitude of cut increasing as the recorded frequency decreased (figure 5A). When the recording technique became advanced enough to reproduce low audio frequencies, it was necessary to reduce the amplitude of the lower frequencies to prevent overcutting the record. A *crossover point* near 500 cycles was chosen,

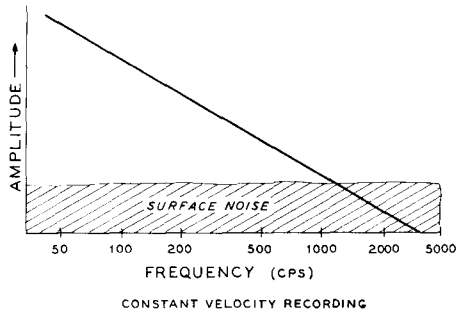

(A)

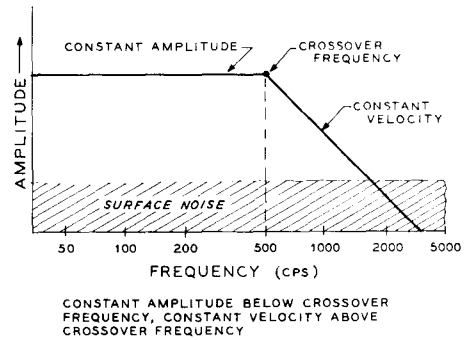

(B)

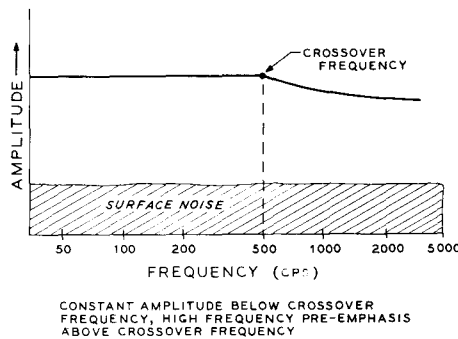

(C)

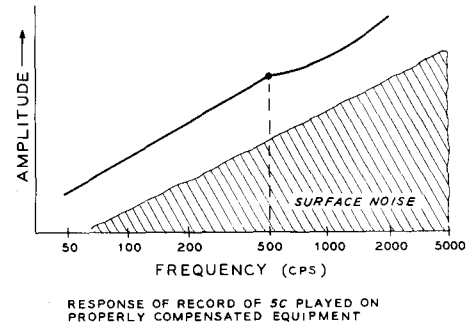

(D)

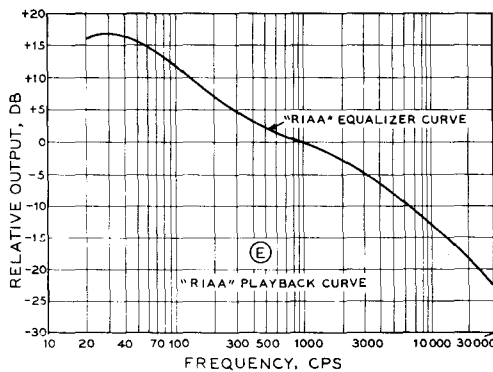

(E)

Figure 5
MODERN PHONOGRAPH RECORD EMPLOYES CONSTANT AMPLITUDE CUT BELOW CROSSOVER POINT AND HIGH FREQUENCY PRE-EMPHASIS (BOOST) ABOVE CROSSOVER FREQUENCY.

and a *constant amplitude* groove was cut below this frequency (figure 5B). This system does not reproduce the higher audio notes, since the recording level rapidly drops into the surface noise level of the record as the cutting frequency is raised. The modern record employs *pre-emphasis* of the higher frequencies to boost them out of the noise level of the record (figure 5C). When such a record is played back on properly compensated equipment, the audio level will remain well above the background noise level, as shown in figure 5D.

The Phonograph Pickup

The most popular types of pickup cartridges in use today are the *high impedance crystal unit*, and the *low impedance variable reluctance* cartridge. The crystal pickup consists of a Rochelle salt element which is warped by the action of the phonograph needle, producing an electrical impulse whose frequency and amplitude are proportional to the modulation of the record groove. One of the new "transducer" crystal cartridges is shown in figure 6. When working into a high impedance load, the output of a high quality crystal pickup is of the

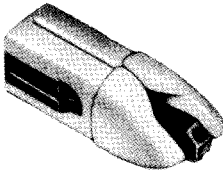

Figure 6
NEW CRYSTAL "TRANSDUCER"
CARTRIDGE PROVIDES HIGH-
FIDELITY OUTPUT AT RELATIVELY
HIGH LEVEL

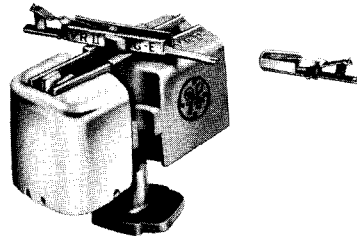

Figure 8
"RELUCTANCE" CARTRIDGE IS
STANDARD PICK-UP FOR
MUSIC SYSTEM.
Low stylus pressure of four grams insures
minimum record wear. Dual stylus is used
having two needle tip diameters for long
playing and 78 R.P.M. recordings.

order of one-half volt or so. Inexpensive crystal units used in 78 r.p.m. record changers and ac-dc phonographs may have as much as two or three volts peak output. The frequency response of a typical high quality crystal pickup is shown in figure 7.

The variable reluctance pickup is shown in figure 8. The reluctance of the air gap in a magnetic circuit is changed by the movement of the phonograph needle, creating a variable voltage in a small coil coupled to the magnetic lines of force of the circuit. The output impedance of the reluctance cartridge is of the order of a few hundred ohms, and the output is approximately 10 millivolts.

For optimum performance, an equalized pre-amplifier stage is usually employed with the reluctance pickup. The circuit of a suitable unit is shown in figure 9. Equalization is provided by R_2 , R_1 , and C_2 , with a low frequency cross-over at about 500 cycles. Total equalization is 15 db. High frequency response may be limited by reducing the value of R_1 to 5,000 — 15,000 ohms.

The standard pickup stylus for 78 r.p.m. records has a tip radius of .0025 inch, whereas the microgroove (33 1/3 and 45 r.p.m.) stylus has a tip radius of .001 inch. Many pickups,

therefore, are designed to have interchangeable cartridges or needles to accommodate the different groove widths.

7-3 The High Fidelity Amplifier

A block diagram of a typical high fidelity system is shown in figure 10. A *preamplifier* is used to boost the output level of the phonograph pickup, and to permit adjustment of input selection, volume, record compensation, and tone control. The preamplifier may be mounted directly at the phonograph turntable position, permitting the larger power amplifier to be placed in an out of the way position.

The *power amplifier* is designed to operate from an input signal of a volt or so derived from the preamplifier, and to build this signal to the desired power level with a minimum amount of distortion. Maximum power output levels of ten to twenty watts are common for home music systems.

The *power supply* provides the smoothed, d-c voltages necessary for operation of the pre-amplifier and power amplifier, and also the

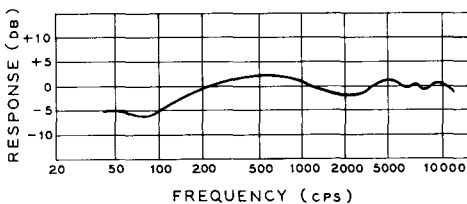

Figure 7
FREQUENCY RESPONSE OF HIGH-
QUALITY CRYSTAL PHONOGRAPH
CARTRIDGE. (ELECTROVOICE 56-DS
POWER POINT TRANSDUCER)

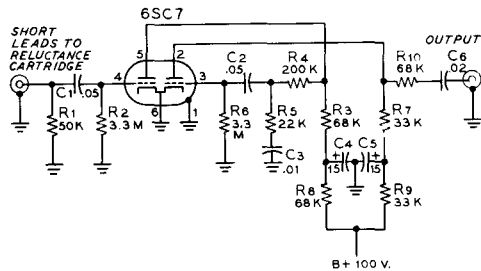

Figure 9
PREAMPLIFIER SUITABLE FOR USE WITH
LOW LEVEL RELUCTANCE CARTRIDGE.

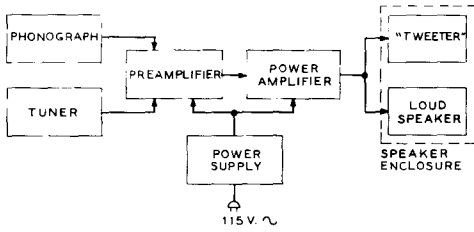

Figure 10
BLOCK DIAGRAM OF HIGH FIDELITY MUSIC SYSTEM.

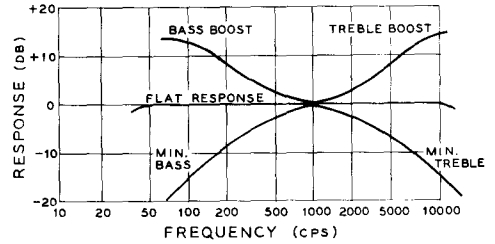
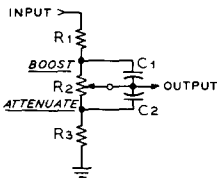
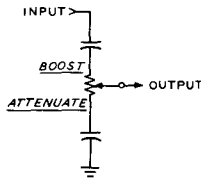

Figure 12
FREQUENCY RESPONSE CURVES FOR THE BASS AND TREBLE BOOST AND ATTENUATION CIRCUITS OF FIGURE 11.

BASS BOOST AND ATTENUATION



TREBLE BOOST AND ATTENUATION



EQUIVALENT CIRCUITS

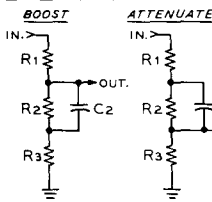

EQUIVALENT CIRCUITS

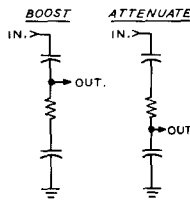

Figure 11
SIMPLE R-C CIRCUITS MAY BE USED FOR BASS AND TREBLE BOOST OR ATTENUATION.

filament voltages (usually a-c) for the heaters of the various amplifier tubes.

The *loudspeaker* is a device which couples the electrical energy of the high fidelity system to the human ear and usually limits the overall fidelity of the complete system. Great advances in speaker design have been made in the past years, permitting the loudspeaker to

hold its own in the race for true fidelity. Speaker efficiency runs from about 10% for cone units to nearly 40% for high frequency *tweeters*. The frequency response of any speaker is a function of the design and construction of the *speaker enclosure* or cabinet that mounts the reproducer.

Tone Compensaton *Equalizer networks* are employed in high fidelity equipment to 1)—tailor the response curve of the system to obtain the correct overall frequency response, 2)—to compensate for inherent faults in the program material, 3)—or merely to satisfy the hearing preference of the listener. The usual compensation networks are combinations of RC and RL networks that provide a gradual attenuation over a given frequency range. The basic RC networks suitable for equalizer service are shown in figure 11. Shunt capacitance is employed for high frequency attenuation, and series capacitance is used for low frequency attenuation. A combination of these simple a-c voltage dividers may be used to provide almost any response, as shown in figure 12. It is common practice to place equalizers between two vacuum tubes in the low level stages of the preamplifier, as shown in figure 13. *Bass and treble boost* and attenuation of the order

Figure 13
BASS AND TREBLE LEVEL CONTROLS, AS EMPLOYED IN THE HEATHKIT WA-P2 PREAMPLIFIER.

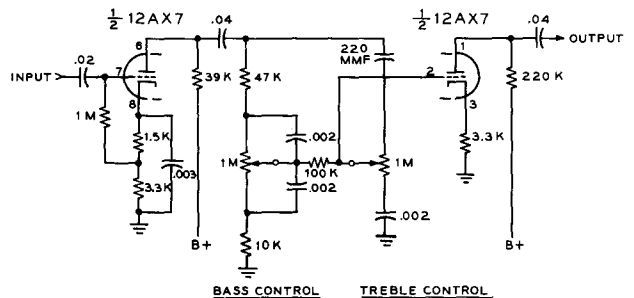

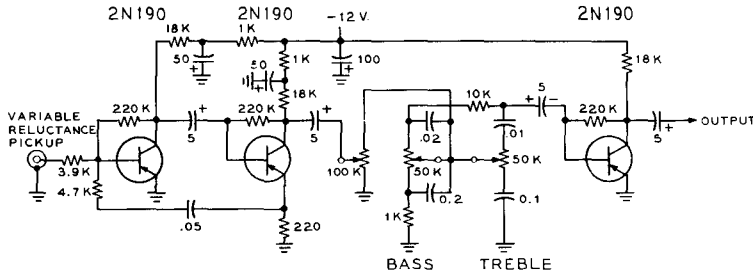

Figure 14
TRANSISTORIZED HIGH-FIDELITY PREAMPLIFIER FOR USE WITH
RELUCTANCE PHONOGRAPH CARTRIDGE.

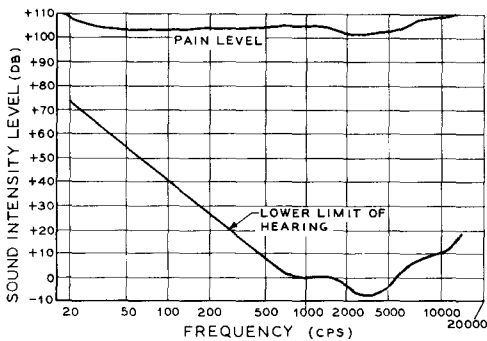
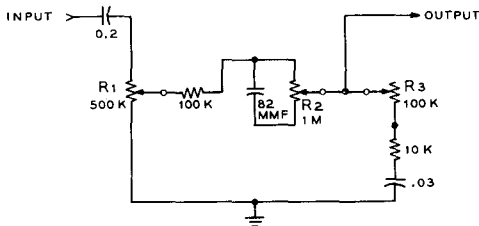

Figure 15
THE "FLETCHER-MUNSON" CURVE
ILLUSTRATING THE INTENSITY
RESPONSE OF THE HUMAN EAR.

of 15 db may be obtained from such a circuit. A simple transistorized preamplifier using this type of equalizing network is shown in figure 14.



R1-R2-R3: THREE SECTION POTENTIOMETER, 1RC TYPE, BUILT UP OF THE FOLLOWING;
 R1-1RC PQ11-133
 R2-1RC MULTISECTION M13-137
 R3-1RC MULTISECTION M13-128

Figure 16
VARIABLE LOUDNESS CONTROL FOR
USE IN LOW IMPEDANCE PLATE
CIRCUITS. MAY BE PURCHASED
AS IRC TYPE LC-1 LOUDNESS
CONTROL.

Loudness Compensator

The minimum threshold of hearing and the maximum threshold of pain vary greatly with the frequency of the sound as shown in the *Fletcher-Munson curves* of figure 15. To maintain a reasonable constant tonal balance as the intensity of the sound is changed it is necessary to employ extra bass and treble boost as the program level is decreased. A simple variable *loudness control* is shown in figure 16 which may be substituted for the ordinary volume control used in most audio equipment.

The Power Amplifier

The power amplifier stage of the music system must supply driving power for the loudspeaker. Commercially available loudspeakers are low impedance devices which present a

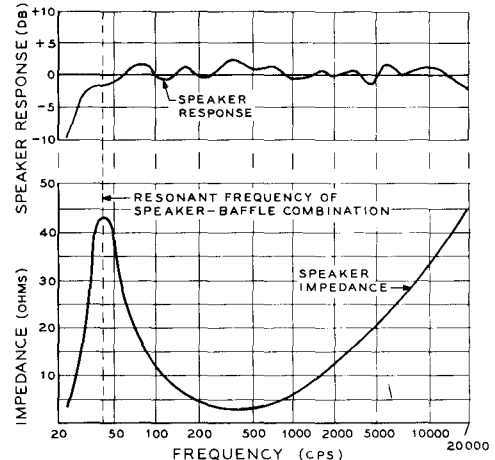

Figure 17
IMPEDANCE AND FREQUENCY
RESPONSE OF "4-OHM" 12-INCH
SPEAKER PROPERLY MOUNTED IN
MATCHING BAFFLE.

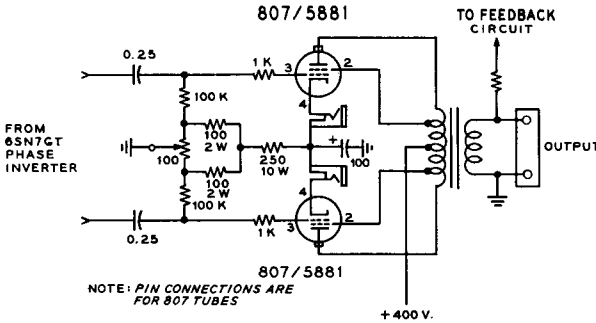

Figure 20
"ULTRA-LINEAR" CONFIGURATION OF WILLIAMSON AMPLIFIER DOUBLES POWER OUTPUT, AND REDUCES IM LEVEL. SCREEN TAPS ON OUTPUT TRANSFORMER PERMIT "SEMI-TETRODE" OPERATION.

is only a fraction of the curve normally used in amplifiers. Thus a comparatively low output power level is obtained with tubes capable of much more efficient operation under less stringent requirements. With 400 volts applied to the output stage, a power output of 10 watts may be obtained with less than 2% intermodulation distortion.

A recent variation of the Williamson circuit involves the use of a tapped output transformer. The screen grids of the push-pull amplifier stage are connected to the primary taps, allowing operating efficiency to approach that of the true pentode. Power output in excess of 25 watts at less than 2% intermodulation dis-

ortion may be obtained with this circuit (figure 20).

7-4 Amplifier Construction

Wiring Techniques Assembly and layout of high fidelity audio amplifiers follows the general technique described for other forms of electronic equipment.

Extra care, however, must be taken to insure that the hum level of the amplifier is extremely low. A good hi-fi system has excellent response in the 60 cycle region, and even a minute quantity of induced a-c voltage will be disagreeably audible in the loudspeaker. Spurious eddy currents produced in the chassis by the power transformer are usually responsible for input stage hum.

To insure the lowest hum level, the power transformer should be of the "upright" type instead of the "half-shell" type which can couple minute voltages from the windings to a steel chassis. In addition, part of the windings of the half-shell type project below the chassis where they are exposed to the input wiring of the amplifier. The core of the power transformer should be placed at right angles to the core of a nearby audio transformer to reduce spurious coupling between the two units to a minimum.

It is common practice in amplifier design to employ a *ground bus* return system for all audio tubes. All grounds are returned to a single heavy bus wire, which in turn is grounded at *one point* to the metal chassis. This ground point is usually at the input jack of the amplifier. When this system is used, a-c chassis currents are not coupled into the amplifying stages. This type of construction is illustrated in the amplifiers described later in this chapter.

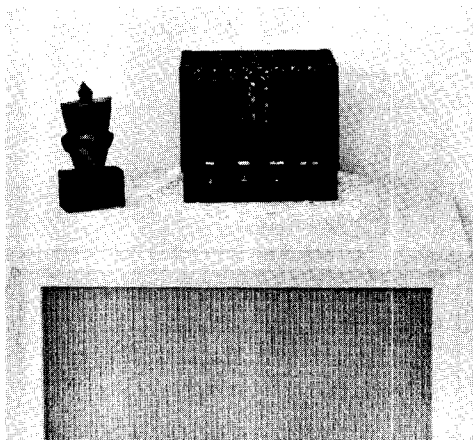

Figure 21
"BABY HI-FI" AMPLIFIER IS DWARFED BY 12-INCH SPEAKER ENCLOSURE
This miniature music system is capable of excellent performance in the small home or apartment. Preamplifier, bass and treble controls, and volume control are all incorporated in the unit. Amplifier provides 4 watts output at 4% 1M distortion.

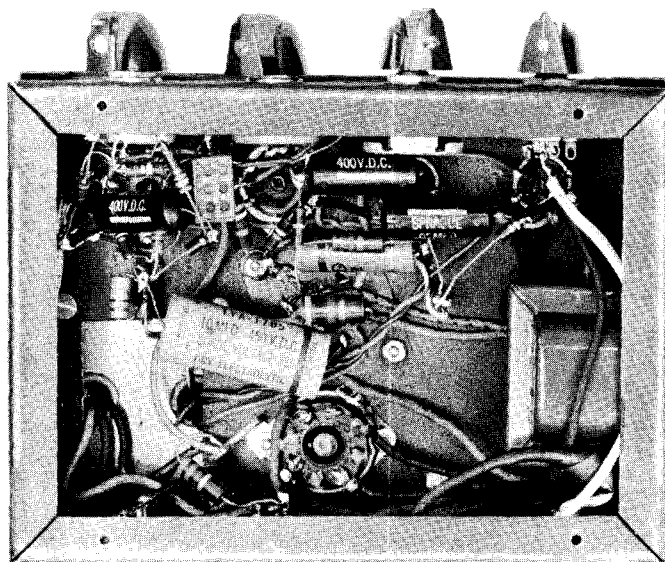

Figure 23
UNDER-CHASSIS
VIEW OF
"BABY HI-FI"

Low level audio stages are at upper left, with components mounted between socket pins and potentiometer controls. 6X5 socket is at lower center of photo with filter choke CH_1 at right. Feedback resistor R_1 is at left of rectifier socket.

ates the necessity of high gain amplifiers required when low level magnetic pickup heads are used. Problems of hum and distortion introduced by these extra stages are thereby eliminated, greatly simplifying the amplifier. The second section of the 12AU7 is used for bass and treble boost. Simple R-C networks are placed in the grid circuit permitting gain boost of over 12 db at the extremities of the response range of the amplifier.

A second 12AU7 is employed as a direct coupled "hot-cathode" phase inverter, capacitively coupled to two 6AQ5 pentode connected

output tubes. The feedback loop is run from the secondary of the output transformer to the cathode of the input section of the phase inverter.

The power supply of the "Baby Hi-Fi" consists of a 6X5-GT rectifier and a capacitor input filter. A second R-C filter section is used to smooth the d-c voltage applied to the 12AU7 tubes. A cathode-type rectifier is used in preference to the usual filament type to prevent voltage surges during the warm-up period of the other cathode-type tubes.

Amplifier Construction The complete amplifier is built upon a small "amplifier foundation" chassis and cover measuring 5"x7"x6" (Bud CA-1754). Height of the amplifier including dust cover is 6". The power transformer (T_1) and output transformer (T_2) are placed in the rear corners of the chassis, with the 6X5-GT rectifier socket placed between them. The small filter choke (CH_1) is mounted to the wall of the chassis and may be seen in the under-chassis photograph of figure 23. The four audio tubes are placed in a row across the front of the chassis. Viewed from the front, the 12AU7 tubes are to the left, and the 6AQ5 tubes are to the right. The three section filter capacitor (C_A, B, C) is a chassis mounting unit, and is placed between the rectifier tube and the four audio tubes. Since the chassis is painted, it is important that good grounding points be made at each tube socket. The paint is cleared away

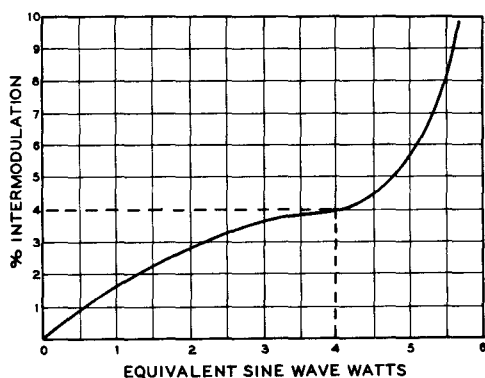
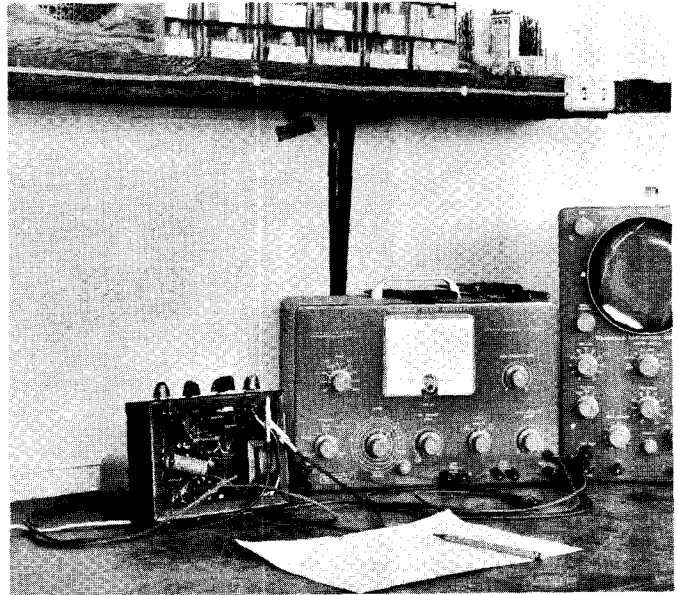

Figure 24
INTERMODULATION CURVE FOR
"BABY HI-FI" AS MEASURED ON
HEATHKIT INTERMODULATION
ANALYZER.

Figure 25
TYPICAL
INTERMODULATION
TEST OF AUDIO
AMPLIFIER.

Audio tones of two frequencies are applied to input of amplifier under test, and amplitude of "sum" or "difference" frequency is measured, providing relative inter-modulation figure.



beneath the socket bolt heads, and lock nuts are used beneath the socket retaining nuts to insure a good ground connection. All ground leads of the first 12AU7 tube are returned to the socket, whereas all grounds for the rest of the circuit are returned to a ground lug of filter capacitor C.

Since the input level to the amplifier is of the order of one-half volt, the problem of chassis ground currents and hum is not so prevalent, as is the case with a high gain input stage.

Phonograph-type coaxial receptacles are mounted on the rear apron of the chassis, serving as the input and output connections. The four panel controls (bass boost, treble boost, volume, and a-c on) are spaced equidistant across the front of the chassis.

Amplifier Wiring The filament wiring should be done first. The center-tap of the filament winding is grounded to a lug of the 6X5-GT socket ring, and the 6.3 volt leads from the transformer are attached to pins 2 and 7 of the same socket. A twisted pair of wires run from the rectifier socket to the right-hand 6AQ5 socket (figure 23). The filament leads then proceed to the next 6AQ5 socket and then to the two 12AU7 sockets in turn.

The 12AU7 preamplifier stage is wired next. A two terminal phenolic tie-point strip is mounted to the rear of the chassis, holding the 12K decoupling resistor and the positive lead

of the 10 μ d., 450-volt filter capacitor. All B-plus leads are run to this point. Most of the components of the bass and treble boost system may be mounted between the tube socket terminals and the terminals of the two potentiometers. The feedback resistor R_1 is mounted between the terminal of the coaxial output connector and a phenolic tie-point strip placed beneath an adjacent socket bolt.

When the wiring has been completed and checked, the amplifier should be turned on, and the various voltages compared with the values given on the schematic. It is important that the polarity of the feedback loop is correct. The easiest way to reverse the feedback polarity

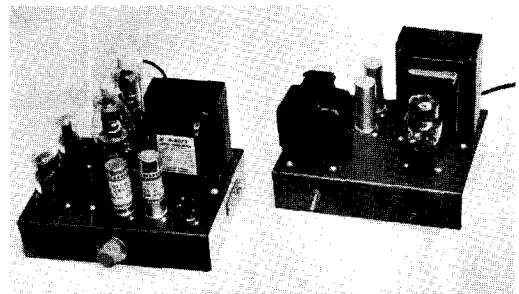
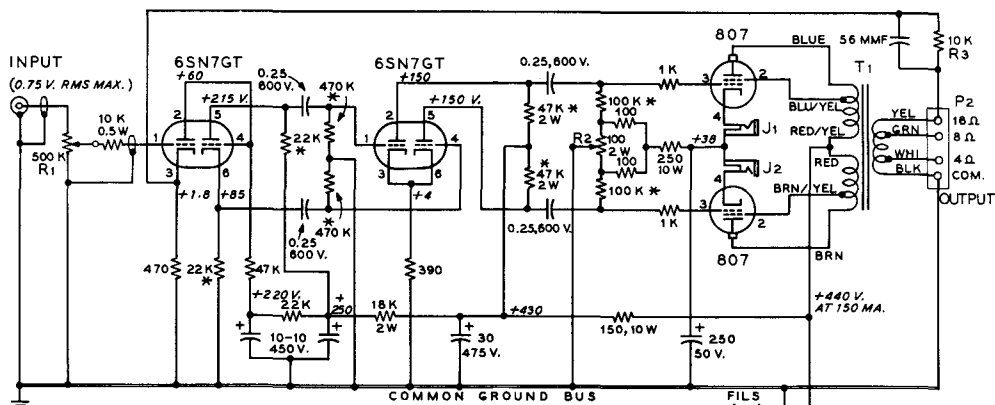

Figure 26
20-WATT "WILLIAMSON-TYPE
AMPLIFIER PROVIDES ULTIMATE IN
LISTENING PLEASURE FOR THE
"GOLDEN EAR."

Amplifier chassis (left) employs two low level stages driving push-pull 807 tubes in so-called "Ultra-linear" circuit. Power supply is at right.



NOTES:

- 1- ALL RESISTORS 1-WATT UNLESS OTHERWISE SPECIFIED
- 2- RESISTORS MARKED * ARE MATCHED PAIRS
- 3- VOLTAGE MEASUREMENTS MADE WITH 1000 OHMS/VOLT VOLTMETER
- 4- JACKS J1 AND J2 ARE INSULATED FROM CHASSIS
- 5- ALL CAPACITOR VALUES GIVEN IN MFD, UNLESS OTHERWISE NOTED
- 6- TRANSFORMER T1: STANCOR A-8072, 7800 OHM PRIMARY
- 7- PUNCHED AND DRILLED CHASSIS, STANCOR WMB

Figure 27
SCHEMATIC OF 20-WATT MUSIC SYSTEM AMPLIFIER.

is to cross-connect the two plate leads of the 6AQ5 tubes. If the feedback polarization is incorrect, the amplifier will oscillate at a supersonic frequency and the reproduced signal will sound fuzzy to the ear. The correct connection may be determined with the aid of an oscilloscope, as the oscillation will be easily found. The builder might experiment with different values of feedback resistor R₁, especially if a speaker of different impedance is employed. Increasing the value of R₁ will decrease the degree of feedback. For an 8-ohm speaker, R₁ should be decreased in value to maintain the same amount of feedback.

This amplifier was used in conjunction with a General Electric S-1201A 12-inch speaker mounted in an Electro-Voice KD6 Aristocrat speaker enclosure which was constructed from a kit. The reproduction was extremely smooth, with good balance of bass and treble.

7-6 A High Quality 25 Watt Amplifier

This amplifier is recommended for the music lover who desires the utmost in high fidelity. Capable of delivering 25 watts output at less than 1.5% intermodulation distortion, the amplifier will provide flawless reproduction at higher than normal listening levels. It is true that other designs have been advocated providing greater power at a lower IM distortion level. However, the improvement in reproduc-

tion of such a system is not noticeable — even to the trained ear — over the results obtained with this low priced amplifier. A full 20 watts of audio power are obtained over the frequency range of 20 to 50,000 cycles at less than 0.1% harmonic distortion. At the average listening level of 1 watt, the frequency response is plus or minus 1 decibel at 100,000 cycles, assuring true high fidelity response over the entire audible range. Pre-amplification and tone compensation are not included in this unit, as these functions are accomplished in the auxiliary driving amplifier. If a variable reluctance cartridge is employed, the preamplifiers of figure 9 or figure 14 may be used with this unit. The Heathkit WA-P2 preamplifier is also recommended for general use when several input circuits are to be employed.

The Amplifier Circuit

The schematic of this amplifier is shown in figure 27. It is a "Williamson-type" amplifier using the so-called "Ultra-linear" screen-tap circuit on the output stage. A dual triode 6SN7-GT serves as a voltage amplifier and direct coupled phase inverter. Maximum signal input to this stage is approximately 0.8 volt, r.m.s. for rated output of the amplifier. The feedback loop from the speaker voice coil is returned to the cathode circuit of the input stage, placing all amplifying stages within the loop.

A second 6SN7-GT is used as a push-pull

Figure 28
UNDER-CHASSIS VIEW
OF 20-WATT AMPLIFIER.
807 SOCKETS ARE AT
CENTER, WITH CATHODE
BALANCING
POTENTIOMETER AT
LOWER RIGHT.

Note ground bus, starting at center, top filter capacitor, and running in loop around underside of chassis. Bus is grounded to chassis at input plug (upper left). Shielded leads run to volume control (center).

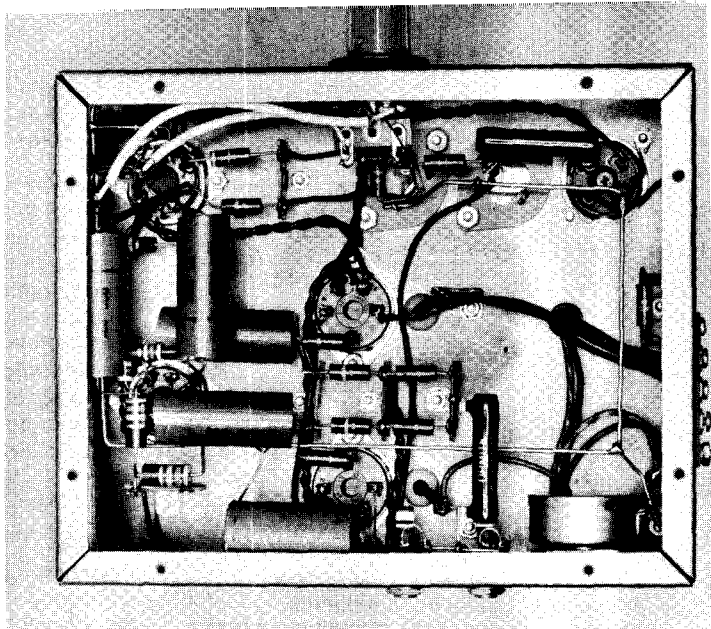

driver stage for the high level output amplifier. A plate potential of 430 volts is applied to this stage to insure ample grid drive to the output stage. Large value coupling capacitors are used between all stages to prevent signal degeneration at the lower audio frequencies. Two 807 beam-power tubes are employed in the final amplifier stage. Cathode bias is applied to these tubes, and the current of the tubes may be equalized by potentiometer R_2 in the bias circuit.

Degenerative feedback is taken from the secondary of the output transformer and applied to the input of the amplifier. The amount of feedback is controlled by the value of feedback resistor R_3 . A small capacitor is placed across R_3 to reduce any tendency towards high frequency parasitic oscillation sometimes encountered when long leads are used to connect the amplifier to the loudspeaker.

An external power supply is used with the amplifier, delivering 440 volts at a current of 175 milliamperes, and 6.3 volts at 5 amperes.

Amplifier Construction The amplifier is built upon a steel chassis measuring 9"x7"x2". Punched and drilled chassis for both the amplifier and power supply may be obtained as standard parts, as specified in figure 27, eliminating the necessity of considerable metal work. Placement of the major components may be seen in the top and under-chassis photographs. The two cathode current jacks, J_1 and J_2 are mounted in over-size holes and are insulated from the chassis with fibre shoulder washers placed on the jack stem, and flat fibre washers beneath the retaining nut. The can-type filter capacitors are in-

sulated from the chassis by fibre mounting boards.

A common ground bus is used in this amplifier, and all "grounds" are returned to the bus, rather than to the chassis. The bus is grounded at the input jack of the amplifier and runs around the underside of the chassis, ending at the ground terminals of the high voltage filter capacitors. Tie-point terminal strips are used to support the smaller components, and direct point-to-point wiring is used.

Matched pairs of resistors should be used in the balanced audio circuits, and these resistors are marked (*) on the schematic. If possible, measure a quantity of resistors in the store with an ohmmeter, and pick out the pairs of resistors that are most evenly matched. The exact resistance value is not critical within 10% as long as the two resistors are close in value. Care must be taken when these resistors are soldered in the circuit, as the heat of the soldering iron may cause the resistance value to vary. It is wise to grasp the resistor lead with a long-nose pliers, holding the lead between the point where the iron is applied and the body of the resistor. The pliers will act as a "heat sink", protecting the resistor from excessive heat.

The filament leads are made up of a twisted pair of wires running between the various sockets. Keep the twisted leads clear of the input jack to insure minimum hum pickup. The plate leads from the 807 caps pass through $\frac{3}{8}$ -inch rubber grommets mounted in the chassis to phenolic tie points mounted beneath the chassis. The plate leads of output transformer T_1 attach to these tie points. Be sure you ob-

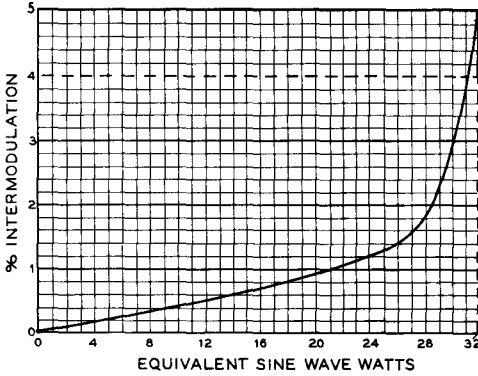

Figure 29
INTERMODULATION CURVE
OF 20-WATT AMPLIFIER.

serve the color code for these leads, as given in figure 27, as the proper polarization of the leads is required for proper feedback operation.

When the amplifier wiring is completed, all connections should be checked for accidental grounds or transpositions. Make sure the meter jacks are insulated from the chassis.

The Power Supply A companion power supply for the high fidelity amplifier is shown in figure 30. A cathode-type 5V4-G rectifier is used to limit the warm-up surge voltages usually encountered in such

a supply. Filament and plate voltages for the *Heathkit WA-P2* preamplifier may be derived from receptacle SO-1. If the preamplifier is not used, or if another type of preamplifier is to be employed, the center-tap of the 6.3 volt filament winding of power transformer T_1 (green/yellow lead) should be grounded to the chassis of the power supply.

Wiring of this unit is straightforward, and no unusual precautions need be taken. It is wise to attach the amplifier to the supply before it is turned to limit warm-up voltage excursions.

Amplifier Operation The amplifier is attached to the power supply by a short length of 4-wire cable. Make sure that the filament leads (pins 1 and 4, P_1) are made of sufficiently heavy wire to insure that the filaments of the amplifier receive a full 6.3 volts. The amplifier should be turned on and all voltages checked against figure 27. A speaker or suitable resistive load should be attached to output terminal strip P_2 , and a 0-100 d-c milliammeter plugged into jacks J_1 and J_2 . Balance potentiometer R_2 is now adjusted until the two readings are the same. Each measurement will be very close to 60 milliamperes when the currents are balanced. The amplifier is now ready for operation, and has a fidelity curve similar to that shown in figure 29.

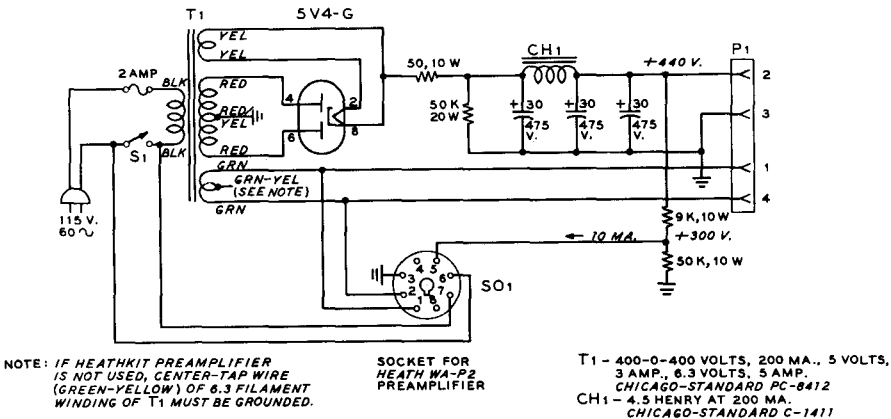

Figure 30
POWER SUPPLY FOR 20-WATT AMPLIFIER.

Radio Frequency Vacuum Tube Amplifiers

TUNED RF VACUUM TUBE AMPLIFIERS

Tuned r-f voltage amplifiers are used in receivers for the amplification of the incoming r-f signal and for the amplification of intermediate frequency signals after the incoming frequency has been converted to the intermediate frequency by the mixer stage. Signal frequency stages are normally called *tuned r-f amplifiers* and intermediate-frequency stages are called *i-f amplifiers*. Both tuned r-f and i-f amplifiers are operated Class A and normally operate at signal levels from a fraction of a microvolt to amplitudes as high as 10 to 50 volts at the plate of the last i-f stage in a receiver.

8-1 Grid Circuit Considerations

Since the full amplification of a receiver follows the first tuned circuit, the operating conditions existing in that circuit and in its coupling to the antenna on one side and to the grid of the first amplifier stage on the other are of greatest importance in determining the signal-to-noise ratio of the receiver on weak signals.

First Tuned Circuit It is obvious that the highest ratio of signal-to-noise be impressed on the grid of the first r-f amplifier tube. Attaining the optimum ratio is a complex problem since noise will be generated in the antenna due to its equivalent radiation resistance (this noise is in addition to any noise of atmospheric origin) and in the

first tuned circuit due to its equivalent coupled resistance at resonance. The noise voltage generated due to antenna radiation resistance and to equivalent tuned circuit resistance is similar to that generated in a resistor due to thermal agitation and is expressed by the following equation:

$$E_n^2 = 4kTR\Delta f$$

Where: E_n = r-m-s value of noise voltage over the interval Δf

k = Boltzman's constant = 1.374 $\times 10^{-22}$ joule per $^\circ\text{K}$.

T = Absolute temperature $^\circ\text{K}$.

R = Resistive component of impedance across which thermal noise is developed.

Δf = Frequency band across which voltage is measured.

In the above equation Δf is essentially the frequency band passed by the intermediate frequency amplifier of the receiver under consideration. This equation can be greatly simplified for the conditions normally encountered in communications work. If we assume the following conditions: $T = 300^\circ\text{K}$ or 27°C or 80.5°F , room temperature; $\Delta f = 8000$ cycles (the average pass band of a communications receiver or speech amplifier), the equation reduces to: $E_{r,m,s.} = 0.0115 \sqrt{R}$ microvolts. Accordingly, the thermal-agitation voltage appearing in the center of half-wave antenna (assuming effective temperature to be 300°K) having a radiation resistance of 73 ohms is

approximately 0.096 microvolts. Also, the thermal agitation voltage appearing across a 500,000-ohm grid resistor in the first stage of a speech amplifier is approximately 8 microvolts under the conditions cited above. Further, the voltage due to thermal agitation being impressed on the grid of the first r-f stage in a receiver by a first tuned circuit whose resonant resistance is 50,000 ohms is approximately 2.5 microvolts. Suffice to say, however, that the value of thermal agitation voltage appearing across the first tuned circuit when the antenna is properly coupled to this circuit will be very much less than this value.

It is common practice to match the impedance of the antenna transmission line to the input impedance of the grid of the first r-f amplifier stage in a receiver. This is the condition of antenna coupling which gives maximum gain in the receiver. However, when u-h-f tubes such as acorns and miniatures are used at frequencies somewhat less than their maximum capabilities, a significant improvement in *signal-to-noise* ratio can be attained by *increasing* the coupling between the antenna and first tuned circuit to a value greater than that which gives greatest signal amplitude out of the receiver. In other words, in the 10, 6, and 2 meter bands it is possible to attain somewhat improved signal-to-noise ratio by increasing antenna coupling to the point where the gain of the receiver is slightly reduced.

It is always possible, in addition, to obtain improved signal-to-noise ratio in a v-h-f receiver through the use of tubes which have improved input impedance characteristics at the frequency in question over conventional types.

Noise Factor The limiting condition for sensitivity in any receiver is the thermal noise generated in the antenna and in the first tuned circuit. However, with proper coupling between the antenna and the grid of the tube, through the first tuned circuit, the noise contribution of the first tuned circuit can be made quite small. Unfortunately, though, the major noise contribution in a properly designed receiver is that of the first tube. The noise contribution due to electron flow and due to losses in the tube can be lumped into an equivalent value of resistance which, if placed in the grid circuit of a perfect tube having the same gain but no noise would give the same noise voltage output in the plate load. The equivalent noise resistance of tubes such as the 6SK7, 6SG7, etc., runs from 5000 to 10,000 ohms. Very high G_m tubes such as the 6AC7 and 6AK5 have equivalent noise resistances as low as 700 to 1500 ohms. The lower the value of equivalent noise resistance, the

lower will be the noise output under a fixed set of conditions.

The equivalent noise resistance of a tube must not be confused with the actual input loading resistance of a tube. For highest signal-to-noise ratio in an amplifier the input loading resistance should be as high as possible so that the amount of voltage that can be developed from grid to ground by the antenna energy will be as high as possible. The equivalent noise resistance should be as low as possible so that the noise generated by this resistance will be lower than that attributable to the antenna and first tuned circuit, and the losses in the first tuned circuit should be as low as possible.

The absolute sensitivity of receivers has been designated in recent years in government and commercial work by an arbitrary dimensionless number known as "noise factor" or N . The noise factor is the ratio of noise output of a "perfect" receiver having a given amount of gain with a dummy antenna matched to its input, to the noise output of the receiver under measurement having the same amount of gain with the dummy antenna matched to its input. Although a perfect receiver is not a physically realizable thing, the noise factor of a receiver under measurement can be determined by calculation from the amount of additional noise (from a temperature-limited diode or other calibrated noise generator) required to increase the noise power output of a receiver by a predetermined amount.

Tube Input Loading As has been mentioned in a previous paragraph, greatest gain in a receiver is obtained when the antenna is matched, through the r-f coupling transformer, to the input resistance of the r-f tube. However, the higher the ratio of tube input resistance to equivalent noise resistance of the tube the higher will be the signal-to-noise ratio of the stage—and of course, the better will be the noise factor of the overall receiver. The input resistance of a tube is very high at frequencies in the broadcast band and gradually decreases as the frequency increases. Tube input resistance on conventional tube types begins to become an important factor at frequencies of about 25 Mc. and above. At frequencies above about 100 Mc. the use of conventional tube types becomes impracticable since the input resistance of the tube has become so much lower than the equivalent noise resistance that it is impossible to attain reasonable signal-to-noise ratio on any but very strong signals. Hence, special v-h-f tube types such as the 6AK5, 6AG5, and 6CB6 must be used.

The lowering of the effective input resist-

ance of a vacuum tube at higher frequencies is brought about by a number of factors. The first, and most obvious, is the fact that the dielectric loss in the internal insulators, and in the base and press of the tube increases with frequency. The second factor is due to the fact that a finite time is required for an electron to move from the space charge in the vicinity of the cathode, pass between the grid wires, and travel on to the plate. The fact that the electrostatic effect of the grid on the moving electron acts over an appreciable portion of a cycle at these high frequencies causes a current flow in the grid circuit which appears to the input circuit feeding the grid as a resistance. The decrease in input resistance of a tube due to electron transit time varies as the square of the frequency. The undesirable effects of transit time can be reduced in certain cases by the use of higher plate voltages. Transit time varies inversely as the square root of the applied plate voltage.

Cathode lead inductance is an additional cause of reduced input resistance at high frequencies. This effect has been reduced in certain tubes such as the 6SH7 and the 6AK5 by providing two cathode leads on the tube base. One cathode lead should be connected to the input circuit of the tube and the other lead should be connected to the by-pass capacitor for the plate return of the tube.

The reader is referred to the Radiation Laboratory Series, Volume 23: "Microwave Receivers" (McGraw-Hill, publishers) for additional information on noise factor and input loading of vacuum tubes.

8-2 Plate-Circuit Considerations

Noise is generated in a vacuum tube by the fact that the current flow within the tube is not a smooth flow but rather is made up of the continuous arrival of particles (electrons) at a very high rate. This *shot effect* is a source of noise in the tube, but its effect is referred back to the grid circuit of the tube since it is included in the *equivalent noise resistance* discussed in the preceding paragraphs.

Plate Circuit Coupling For the purpose of this section, it will be considered that the function of the plate load circuit of a tuned vacuum-tube amplifier is to deliver energy to the next stage with the greatest efficiency over the required band of frequencies. Figure 1 shows three methods of inter-stage coupling for tuned r-f voltage amplifiers. In figure 1A ω is 2π times the resonant frequency of the circuit in the plate of

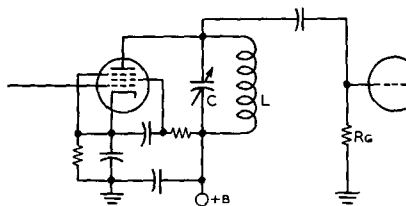

(A) AMPLIFICATION AT RESONANCE (APPROX.) = $G_m \omega L Q$

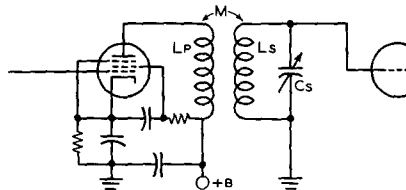

(B) AMPLIFICATION AT RESONANCE (APPROX.) = $G_m \omega M Q$

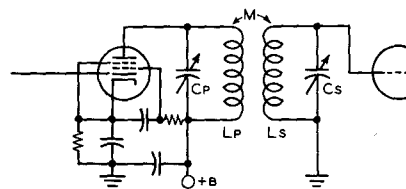

(C) AMPLIFICATION AT RESONANCE (APPROX.) = $G_m K \frac{\omega \sqrt{L_P L_S}}{K^2 + \frac{1}{Q_P Q_S}}$

WHERE: 1. PRI. AND SEC. RESONANT AT SAME FREQUENCY
2. K IS COEFFICIENT OF COUPLING

IF PRI. AND SEC. Q ARE APPROXIMATELY THE SAME:
 $\frac{\text{TOTAL BANDWIDTH}}{\text{CENTER FREQUENCY}} = 1.2 K$

MAXIMUM AMPLITUDE OCCURS AT CRITICAL COUPLING -
WHEN $K = \frac{1}{\sqrt{Q_P Q_S}}$

Figure 1

Gain equations for pentode r-f amplifier stages operating into a tuned load

the amplifier tube, and L and Q are the inductance and Q of the inductor L. In figure 1B the notation is the same and M is the mutual inductance between the primary coil and the secondary coil. In figure 1C the notation is again the same and k is the coefficient of coupling between the two tuned circuits. As the coefficient of coupling between the circuits is increased the bandwidth becomes greater but the response over the band becomes progressively more double-humped. The response over the band is the most flat when the Q's of primary and secondary are approximately the same and the value of each Q is equal to $1.75/k$.

Variable-Mu Tubes in R-F Stages It is common practice to control the gain of a succession of r-f or i-f amplifier stages by varying the average bias on their control grids. However, as the bias is raised above the operating value on a conventional sharp-cutoff tube the tube becomes increasingly non-linear in operation as cutoff of plate current is approached. The effect of such non-linearity is to cause cross modulation between strong signals which appear on the grid of the tube. When a tube operating in such a manner is in one of the first stages of a receiver a number of signals are appearing on its grid simultaneously and cross modulation between them will take place. The result of this effect is to produce a large number of spurious signals in the output of the receiver—in most

cases these signals will carry the modulation of both the carriers which have been cross modulated to produce the spurious signal.

The undesirable effect of cross modulation can be eliminated in most cases and greatly reduced in the balance through the use of a variable-mu tube in all stages which have a-v-c voltage or other large negative bias applied to their grids. The variable-mu tube has a characteristic which causes the cutoff of plate current to be gradual with an increase in grid bias, and the reduction in plate current is accompanied by a decrease in the effective amplification factor of the tube. Variable-mu tubes ordinarily have somewhat reduced G_m as compared to a sharp-cutoff tube of the same group. Hence the sharp-cutoff tube will perform best in stages to which a-v-c voltage is not applied.

RADIO-FREQUENCY POWER AMPLIFIERS

All modern transmitters in the medium-frequency range and an increasing percentage of those in the v-h-f and u-h-f ranges consist of a comparatively low-level source of radio-frequency energy which is multiplied in frequency and successively amplified to the desired power level. Microwave transmitters are still predominately of the self-excited oscillator type, but when it is possible to use r-f amplifiers in s-h-f transmitters the flexibility of their application will be increased. The following portion of this chapter will be devoted, however, to the method of operation and calculation of operating characteristics of r-f power amplifiers for operation in the range of approximately 3.5 to 500 Mc.

8-3 Class C R-F Power Amplifiers

The majority of r-f power amplifiers fall into the Class C category since such stages can be made to give the best plate circuit efficiency of any present type of vacuum-tube amplifier. Hence, the cost of tubes for such a stage and the cost of the power to supply that stage is least for any given power output. Nevertheless, the Class C amplifier gives less power gain than either a Class A or Class B amplifier under similar conditions since the grid of a Class C stage must be driven highly positive over the portion of the cycle of the exciting wave when the plate voltage on the amplifier is low, and must be at a large negative potential over a large portion of the cycle so

that no plate current will flow except when plate voltage is very low. This, in fact, is the fundamental reason why the plate circuit efficiency of a Class C amplifier stage can be made high—plate current is cut off at all times except when the plate-to-cathode voltage drop across the tube is at its lowest value. Class C amplifiers almost invariably operate into a tuned tank circuit as a load, and as a result are used as amplifiers of a single frequency or of a comparatively narrow band of frequencies.

Relationships in Class C Stage Figure 2 shows the relationships between the various voltages and currents over one cycle of the exciting grid voltage for a Class C amplifier stage. The notation given in figure 2 and in the discussion to follow is the same as given at the first of Chapter Six under "Symbols for Vacuum-Tube Parameters."

The various manufacturers of vacuum tubes publish booklets listing in adequate detail alternative Class C operating conditions for the tubes which they manufacture. In addition, operating condition sheets for any particular type of vacuum tube are available for the asking from the different vacuum-tube manufacturers. It is, nevertheless, often desirable to determine optimum operating conditions for a tube under a particular set of circumstances. To assist in such calculations the following paragraphs are devoted to a method of calculating Class C operating conditions which is moderately simple and yet sufficiently accurate for all practical purposes.

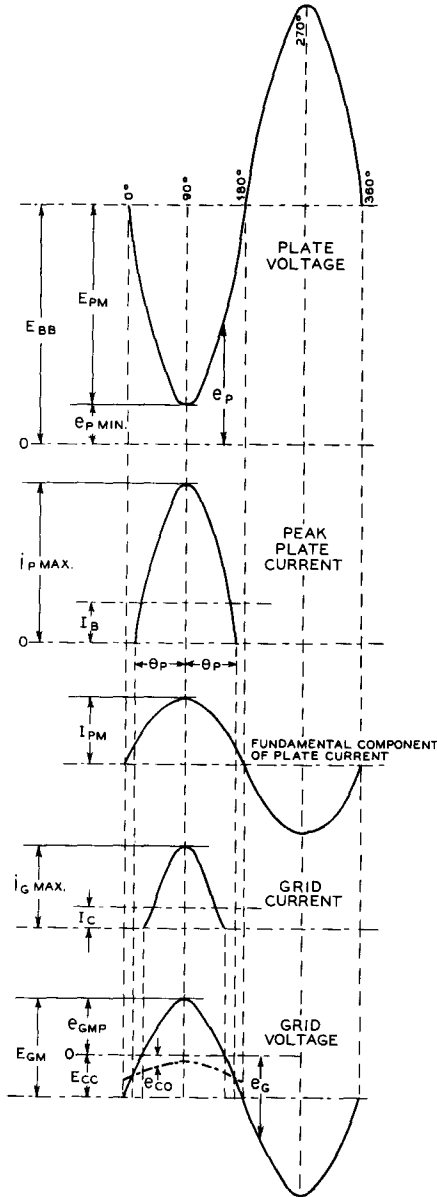

Figure 2
Instantaneous electrode and tank circuit voltages and currents for a Class C r-f power amplifier

tional grid voltage-plate current operating curves, the calculation is considerably simplified if the alternative "constant-current curve" of the tube in question is used. This is true since the operating line of a Class C amplifier is a straight line on a set of constant-current curves. A set of constant-current curves on the 250TH tube with a sample load line drawn thereon is shown in figure 5.

In calculating and predicting the operation of a vacuum tube as a Class C radio-frequency amplifier, the considerations which determine the operating conditions are plate efficiency, power output required, maximum allowable plate and grid dissipation, maximum allowable plate voltage and maximum allowable plate current. The values chosen for these factors will depend both upon the demands of a particular application and upon the tube chosen.

The plate and grid currents of a Class C amplifier tube are periodic pulses, the durations of which are always less than 180 degrees. For this reason the average grid current, average plate current, power output, driving power, etc., cannot be directly calculated but must be determined by a Fourier analysis from points selected at proper intervals along the line of operation as plotted upon the constant-current characteristics. This may be done either analytically or graphically. While the Fourier analysis has the advantage of accuracy, it also has the disadvantage of being tedious and involved.

The approximate analysis which follows has proved to be sufficiently accurate for most applications. This type of analysis also has the advantage of giving the desired information at the first trial. The system is direct in giving the desired information since the important factors, power output, plate efficiency, and plate voltage are arbitrarily selected at the beginning.

Method of Calculation The first step in the method to be described is to determine the power which must be delivered by the Class C amplifier. In making this determination it is well to remember that ordinarily from 5 to 10 per cent of the power delivered by the amplifier tube or tubes will be lost in well-designed tank and coupling circuits at frequencies below 20 Mc. Above 20 Mc. the tank and circuit losses are ordinarily somewhat above 10 per cent.

The plate power input necessary to produce the desired output is determined by the plate efficiency: $P_{in} = P_{out}/\eta_p$.

For most applications it is desirable to operate at the highest practicable efficiency. High-efficiency operation usually requires less expensive tubes and power supplies, and the

Calculation of Class C Amplifier Operating Characteristics

Although Class C operating conditions can be determined with the aid of the more conven-

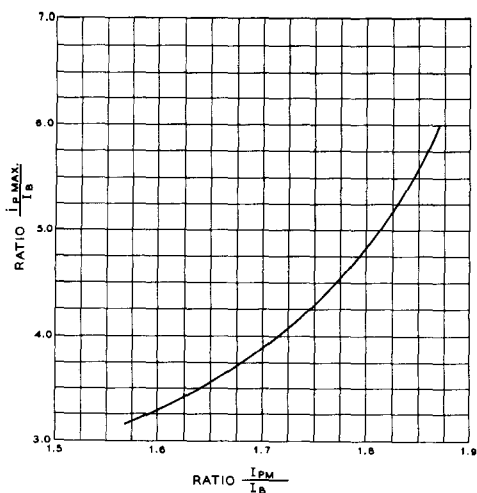

Figure 3

Relationship between the peak value of the fundamental component of the tube plate current, and average plate current; as compared to the ratio of the instantaneous peak value of tube plate current, and average plate current

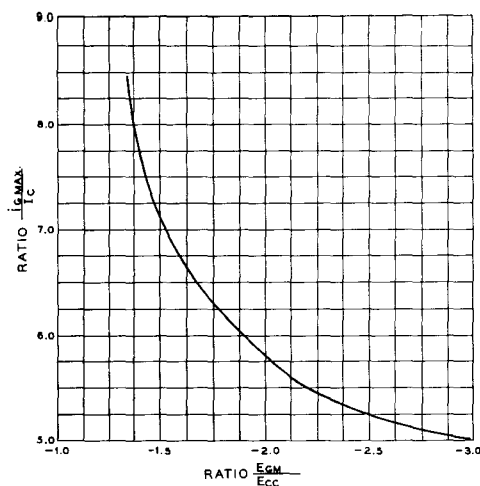

Figure 4

Relationship between the ratio of the peak value of the fundamental component of the grid excitation voltage, and the average grid bias; as compared to the ratio between instantaneous peak grid current and average grid current

amount of artificial cooling required is frequently less than for low-efficiency operation. On the other hand, high-efficiency operation usually requires more driving power and involves the use of higher plate voltages and higher peak tube voltages. The better types of triodes will ordinarily operate at a plate efficiency of 75 to 85 per cent at the highest rated plate voltage, and at a plate efficiency of 65 to 75 per cent at intermediate values of plate voltage.

The first determining factor in selecting a tube or tubes for a particular application is the amount of plate dissipation which will be required of the stage. The total plate dissipation rating for the tube or tubes to be used in the stage must be equal to or greater than that calculated from: $P_p = P_{in} - P_{out}$.

After selecting a tube or tubes to meet the power output and plate dissipation requirements it becomes necessary to determine from the tube characteristics whether the tube selected is capable of the desired operation and, if so, to determine the driving power, grid bias, and grid dissipation.

The complete procedure necessary to determine a set of Class C amplifier operating conditions is given in the following steps:

1. Select the plate voltage, power output, and efficiency.

2. Determine plate input from: $P_{in} = P_{out}/N_p$.

3. Determine plate dissipation from: $P_p = P_{in} - P_{out}$. P_p must not exceed maximum rated plate dissipation for tube or tubes selected.

4. Determine average plate current from: $I_b = P_{in}/E_{bb}$.

5. Determine approximate i_{pmax} from:
 - $i_{pmax} = 4.9 I_b$ for $N_p = 0.85$
 - $i_{pmax} = 4.5 I_b$ for $N_p = 0.80$
 - $i_{pmax} = 4.0 I_b$ for $N_p = 0.75$
 - $i_{pmax} = 3.5 I_b$ for $N_p = 0.70$

6. Locate the point on constant-current characteristics where the constant plate current line corresponding to the approximate i_{pmax} determined in step 5 crosses the line of equal plate and grid voltages (diode line). Read e_{pmin} at this point. In a few cases the lines of constant plate current will inflect sharply upward before reaching the diode line. In these cases e_{pmin} should not be read at the diode line but at the point where the plate current line intersects a line drawn from the origin through these points of inflection.

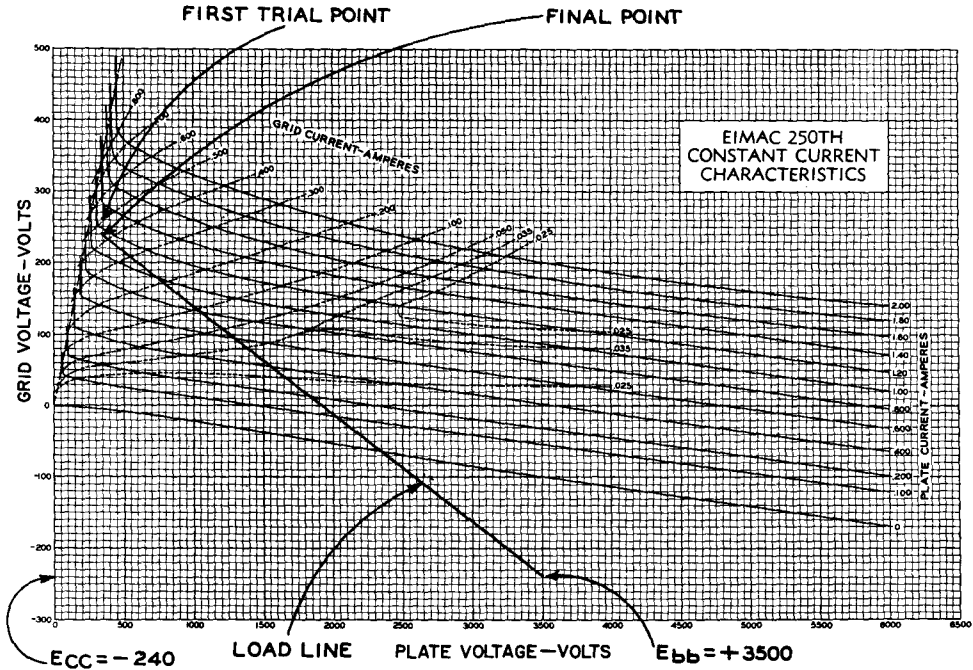

FIGURE 5
Active portion of the operating load line for an Eimac 250TH Class C r-f power amplifier, showing first trial point and the final operating point

7. Calculate E_{pm} from: $E_{pm} = E_{bb} - e_{pmin}$.
8. Calculate the ratio I_{pm}/I_b from:

$$\frac{I_{pm}}{I_b} = \frac{2 N_p E_{bb}}{E_{pm}}$$
9. From the ratio of I_{pm}/I_b calculated in step 8 determine the ratio i_{pmax}/I_b from figure 3.
10. Calculate a new value for i_{pmax} from the ratio found in step 9.
 $i_{pmax} = (\text{ratio from step 9}) I_b$
11. Read e_{gmp} and i_{gmax} from the constant-current characteristics for the values of e_{pmin} and i_{pmax} determined in steps 6 and 10.

12. Calculate the cosine of one-half the angle of plate current flow from:

$$\cos \theta_p = 2.32 \left(\frac{I_{pm}}{I_b} - 1.57 \right)$$

13. Calculate the grid bias voltage from:

$$E_{cc} = \frac{1}{1 - \cos \theta_p} \times \left[\cos \theta_p \left(\frac{E_{pm}}{\mu} - e_{gmp} \right) - \frac{E_{bb}}{\mu} \right]$$

for triodes.

$$E_{cc} = \frac{1}{1 - \cos \theta_p} \times \left[-e_{gmp} \cos \theta - \frac{E_{c2}}{\mu_{12}} \right]$$

for tetrodes, where μ_{12} is the grid-screen amplification factor, and E_{c2} is the d-c screen voltage.

14. Calculate the peak fundamental grid excitation voltage from:

$$E_{gm} = e_{gmp} - E_{cc}$$

15. Calculate the ratio E_{gm}/E_{cc} for the val-

ues of E_{cc} and E_{gm} found in steps 13 and 14.

16. Read i_{gmax}/I_c from figure 4 for the ratio E_{gm}/E_{cc} found in step 15.
17. Calculate the average grid current from the ratio found in step 16, and the value of i_{gmax} found in step 11:

$$I_c = \frac{i_{gmax}}{\text{Ratio from step 16}}$$

18. Calculate approximate grid driving power from:

$$P_d = 0.9 E_{gm} I_c$$

19. Calculate grid dissipation from:

$$P_g = P_d + E_{cc} I_c$$

P_g must not exceed the maximum rated grid dissipation for the tube selected.

Sample Calculation A typical example of a Class C amplifier calculation is shown in the example below. Reference is made to figures 3, 4 and 5 in the calculation.

1. Desired power output—800 watts.
2. Desired plate voltage—3500 volts.
Desired plate efficiency—80 per cent ($N_p = 0.80$)
 $P_{in} = 800/0.80 = 1000$ watts
3. $P_p = 1000 - 800 = 200$ watts
Use 250TH; max. $P_p = 250$ w; $\mu = 37$.
4. $I_b = 1000/3500 = 0.285$ ampere (285 ma.)
Max. I_b for 250TH is 350 ma.
5. Approximate $i_{pmax} = 0.285 \times 4.5 = 1.28$ ampere
6. $e_{pmin} = 260$ volts (see figure 5 first trial point)
7. $E_{pm} = 3500 - 260 = 3240$ volts
8. $I_{pm}/I_b = 2 \times 0.80 \times 3500/3240 = 5600/3240 = 1.73$
9. $i_{pmax}/I_b = 4.1$ (from figure 3)
10. $i_{pmax} = 0.285 \times 4.1 = 1.17$
11. $e_{gmp} = 240$ volts
 $i_{gmax} = 0.430$ amperes
(Both above from final point on figure 5)

$$12. \cos \theta_p = 2.32 (1.73 - 1.57) = 0.37$$

$$(\theta_p = 68.3^\circ)$$

$$13. E_{cc} = \frac{1}{1 - 0.37} \times \left[0.37 \left(\frac{3240}{37} - 240 \right) - \frac{3500}{37} \right]$$

$$= -240 \text{ volts}$$

$$14. E_{gm} = 240 - (-240) = 480 \text{ volts grid swing}$$

$$15. E_{gm}/E_{cc} = 480 / -240 = -2$$

$$16. i_{gmax}/I_c = 5.75 \text{ (from figure 4)}$$

$$17. I_c = 0.430/5.75 = 0.075 \text{ amp. (75 ma. grid current)}$$

$$18. P_d = 0.9 \times 480 \times 0.075 = 32.5 \text{ watts driving power}$$

$$19. P_g = 32.5 - (-240 \times 0.075) = 14.5 \text{ watts grid dissipation}$$

Max. P_g for 250TH is 40 watts

The power output of any type of r-f amplifier is equal to:

$$I_{pm} E_{pm} / 2 = P_o$$

I_{pm} can be determined, of course, from the ratio determined in step 8 above (in this type of calculation) by multiplying this ratio times I_b .

It is frequently of importance to know the value of load impedance into which a Class C amplifier operating under a certain set of conditions should operate. This is simply $R_L = E_{pm}/I_{pm}$. In the case of the operating conditions just determined for a 250TH amplifier stage the value of load impedance is:

$$R_L = \frac{E_{pm}}{I_{pm}} = \frac{3240}{.495} = 6600 \text{ ohms}$$

$$I_{pm} = \frac{I_{pm}}{I_b} \times I_b$$

Q of Amplifier Tank Circuit In order to obtain good plate tank circuit tuning and low radiation of harmonics from an amplifier it is necessary that the plate tank circuit have the correct Q. Charts giving compromise values of Q for Class C amplifiers are given in the chapter, *Generation of R-F Energy*. However, the amount of inductance required for a specified tank circuit Q under specified operating conditions can be calculated from the following expression:

$$\omega L = \frac{R_L}{Q}$$

- ω = $2\pi \times$ operating frequency
- L = Tank inductance
- R_L = Required tube load impedance
- Q = Effective tank circuit Q

A tank circuit Q of 12 to 20 is recommended for all normal conditions. However, if a balanced push-pull amplifier is employed the tank receives two impulses per cycle and the circuit Q may be lowered somewhat from the above values.

Quick Method of Calculating Amplifier Plate Efficiency

The plate circuit efficiency of a Class B or Class C r-f amplifier can be determined from

the following facts. The plate circuit efficiency of such an amplifier is equal to the product of two factors, F_1 , which is equal to the ratio of E_{pm} to E_{bb} ($F_1 = E_{pm}/E_{bb}$) and F_2 , which is proportional to the one-half angle of plate current flow, θ_p . A graph of F_2 against both θ_p and $\cos \theta_p$ is given in figure 6. Either θ_p or $\cos \theta_p$ may be used to determine F_2 . $\cos \theta_p$ may be determined either from the procedure previously given for making Class C amplifier computations or it may be determined from the following expression:

$$\cos \theta_p = - \frac{\mu E_{cc} + E_{bb}}{\mu E_{gm} - E_{pm}}$$

Example of Method

It is desired to know the one-half angle of plate current flow and the plate circuit efficiency for an 812 tube operating under the following conditions which have been assumed from inspection of the data and curves given in the RCA Transmitting Tube Handbook HB-3:

1. $E_{bb} = 1100$ volts
 $E_{cc} = -40$ volts
 $\mu = 29$
 $E_{gm} = 120$ volts
 $E_{pm} = 1000$ volts

2. $F_1 = E_{pm}/E_{bb} = 0.91$

3. $\cos \theta_p = \frac{-29 \times 40 + 1100}{29 \times 120 - 1000} = \frac{60}{2480} = 0.025$

4. $F_2 = 0.79$ (by reference to figure 6)

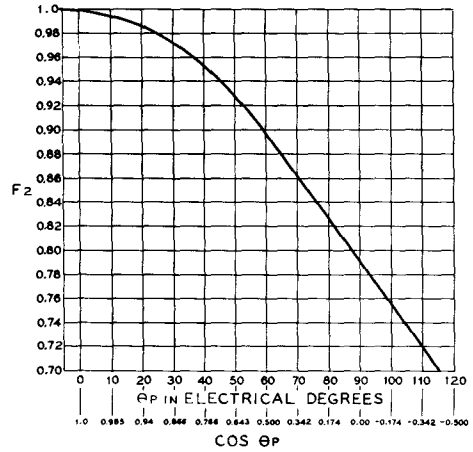

Figure 6

Relationship between Factor F_2 and the half-angle of plate current flow in an amplifier with sine-wave input and output voltage, operating at a grid-bias voltage greater than cut-off

5. $N_p = F_1 \times F_2 = 0.91 \times 0.79 = 0.72$
 (72 per cent efficiency)

F_1 could be called the plate-voltage-swing efficiency factor, and F_2 can be called the operating-angle efficiency factor or the maximum possible efficiency of any stage running with that value of half-angle of plate current flow.

N_p is, of course, only the ratio between power output and power input. If it is desired to determine the power input, exciting power, and grid current of the stage, these can be obtained through the use of steps 7, 8, 9, and 10 of the previously given method for power input and output; and knowing that i_{gmax} is 0.095 ampere the grid circuit conditions can be determined through the use of steps 15, 16, 17, 18 and 19.

8-4 Class B Radio Frequency Power Amplifiers

Radio frequency power amplifiers operating under Class B conditions of grid bias and excitation voltage are used in two general types of applications in transmitters. The first general application is as a buffer amplifier stage where it is desired to obtain a high value of power amplification in a particular stage. A particular tube type operated with a given plate voltage will be capable of somewhat greater output for a certain amount of excitation power when operated as a Class B ampli-

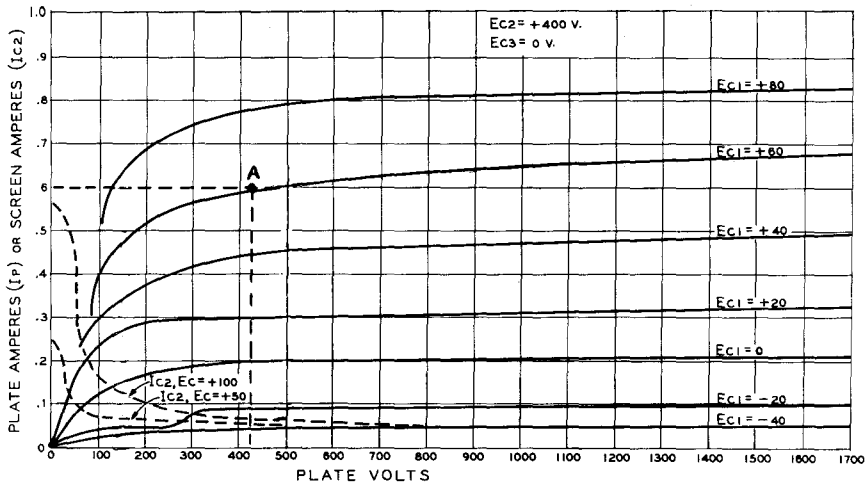

Figure 7
AVERAGE PLATE CHARACTERISTICS OF 813 TUBE

fier than when operated as a Class C amplifier.

Calculation of Operating Characteristics Calculation of the operating conditions for this type of Class B r-f amplifier can be carried out in a manner similar to that described in the previous paragraphs, except that the grid bias voltage is set on the tube before calculation at the value: $E_{cc} = -E_{bb}/\mu$. Since the grid bias is set at cutoff the one-half angle of plate current flow is 90° ; hence $\cos \theta_p$ is fixed at 0.00. The plate circuit efficiency for a Class B r-f amplifier operated in this manner can be determined in the following manner:

$$N_p = 78.5 \left(\frac{E_{pm}}{E_{bb}} \right)$$

The "Class B Linear" The second type of Class B r-f amplifier is the so-called *Class B linear amplifier* which is often used in transmitters for the amplification of a single-sideband signal or a conventional amplitude-modulated wave. Calculation of operating conditions may be carried out in a manner similar to that previously described with the following exceptions: The first trial operating point is chosen on the basis of the 100 per cent positive modulation peak of the modulated exciting wave. The plate circuit and grid peak voltages and currents can then be determined and the power input and output

calculated. Then, with the exciting voltage reduced to one-half for the no-modulation condition of the exciting wave, and with the same value of load resistance reflected on the tube, the plate input and plate efficiency will drop to approximately one-half the values at the 100 per cent positive modulation peak and the power output of the stage will drop to one-fourth the peak-modulation value. On the negative modulation peak the input, efficiency, and output all drop to zero.

In general, the proper plate voltage, bias voltage, load resistance and power output listed in the tube tables for Class B audio work will also apply to Class B linear r-f application.

Calculation of Operating Parameters for a Class B Linear Amplifier Figure 7 illustrates the characteristic curves for an 813 tube. Assume the plate supply to be 2000 volts, and the screen supply to be 400 volts. To determine the operating parameters of this tube as a Class B linear r-f amplifier, the following steps should be taken:

1. The grid bias is chosen so that the resting plate current will produce approximately 1/3 of the maximum plate dissipation of the tube. The maximum dissipation of the 813 is 125 watts, so the bias is set to allow one-third of this value, or 42 watts of resting dissipation. At a plate potential of 2000 volts, a

plate current of 21 milliamperes will produce this figure. Referring to figure 7, a grid bias of -45 volts is approximately correct.

2. A practical Class B linear r-f amplifier runs at an efficiency of about 66% at full output, the efficiency dropping to about 33% with an unmodulated exciting signal. In the case of single-sideband suppressed carrier excitation, a no-excitation condition is substituted for the unmodulated excitation case, and the linear amplifier runs at the resting or quiescent input of 42 watts with no exciting signal. The peak allowable power input to the 813 is:

$$\begin{aligned} \text{Input Peak Power } (W_p) &= \\ & \text{(watts)} \\ \text{Plate Dissipation} \times 100 &= \\ \frac{(100 - \% \text{ plate efficiency})}{125} &= \\ \frac{33}{125} \times 100 &= 379 \text{ watts} \end{aligned}$$

3. The maximum signal plate current is:

$$i_{p \max} = \frac{W_p}{E_p} = \frac{379}{2000} = 0.189 \text{ ampere}$$

4. The plate current flow of the linear amplifier is 1809, and the plate current pulses have a peak of 3.14 times the maximum signal current:

$$3.14 \times 0.189 = 0.595 \text{ ampere}$$

5. Referring to figure 7, a current of 0.605 ampere (Point A) will flow at a positive grid potential of 60 volts and a minimum plate potential of 420 volts. The grid is biased at -45 volts, so a peak r-f grid voltage of 60 + 45 volts = 105 volts is required.

6. The grid driving power required for the Class B linear stage may be found by the aid of figure 8. It is one-quarter the product of the peak grid current times the peak grid voltage:

$$P_g = \frac{0.02 \times 105}{4} = 0.53 \text{ watt}$$

7. The single tone power output of the 813 stage is:

$$\begin{aligned} P_p &= 78.5 (E_p - e_{p \min}) \times I_p \\ P_p &= 78.5 (2000 - 420) \times .189 = 235 \text{ watts} \end{aligned}$$

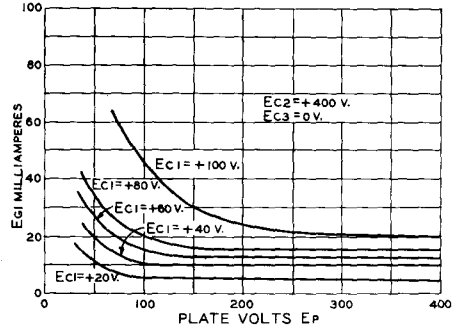

Figure 8
E_{g1} VS. E_p CHARACTERISTICS OF 813 TUBE

8. The plate load resistance is:

$$R_L = \frac{E_p - e_{p \min}}{0.5 i_{p \max}} = \frac{1580}{0.5 \times .189} = 6000 \text{ ohms}$$

9. If a loaded plate tank circuit Q of 12 is desired, the reactance of the plate tank capacitor at the resonant frequency should be:

$$\text{Reactance (ohms)} = \frac{R_L}{Q} = \frac{6000}{12} = 500 \text{ ohms}$$

10. For an operating frequency of 4.0 Mc., the effective resonant capacity is:

$$C = \frac{10^6}{6.28 \times 4.0 \times 500} = 80 \mu\text{fd.}$$

11. The inductance required to resonate at 4.0 Mc. with this value of capacity is:

$$L = \frac{500}{6.28 \times 4.0} = 19.9 \text{ microhenries}$$

Grid Circuit Considerations

1. The maximum positive grid potential is 60 volts, and the peak r-f grid voltage is 105 volts. Required driving power is 0.53 watt. The equivalent grid resistance of this stage is:

$$R_g = \frac{(e_g)^2}{2 \times P_g} = \frac{105^2}{2 \times 0.53} = 10,400 \text{ ohms}$$

- As in the case of the Class B audio amplifier the grid resistance of the linear amplifier varies from infinity to a low value when maximum grid current is drawn. To decrease the effect of this resistance excursion, a swamping resistor should be placed across the grid tank circuit. The value of the resistor should be dropped until a shortage of driving power begins to be noticed. For this example, a resistor of 3,000 ohms is used. The grid circuit load for no grid current is now 3,000 ohms instead of infinity, and drops to 2400 ohms when maximum grid current is drawn.
- A circuit Q of 15 is chosen for the grid tank. The capacitive reactance required is:

$$X_C = \frac{2400}{15} = 160 \text{ ohms}$$

- At 4.0 Mc. the effective capacity is:

$$C = \frac{10^6}{6.28 \times 4 \times 154} = 248 \mu\text{fd.}$$

- The inductive reactance required to resonate the grid circuit at 4.0 Mc. is:

$$L = \frac{160}{6.28 \times 4.0} = 6.4 \text{ microhenries}$$

- By substituting the loaded grid resistance figure in the formula in the first paragraph, the grid driving power is now found to be approximately 2.3 watts.

Screen Circuit Considerations By reference to the plate characteristic curve of the 813 tube, it can be seen that at a minimum plate potential of 500 volts, and a maximum plate current of 0.6 ampere, the screen current will be approximately 30 milliamperes, dropping to one or two milliamperes in the quiescent state. It is necessary to use a well-regulated screen supply to hold the screen voltage at the correct potential over this range of current excursion. The use of an electronic regulated screen supply is recommended.

8-5 Special R-F Power Amplifier Circuits

The r-f power amplifier discussions of Sections 8-4 and 8-5 have been based on the assumption that a conventional grounded-cathode or cathode-return type of amplifier was in question. It is possible, however, as in the case of a-f and low-level r-f amplifiers to use circuits in which electrodes other than the cathode are returned to ground insofar as the signal potential is concerned. Both the plate-return or cathode-follower amplifier and the grid-return or grounded-grid amplifier are effective in certain circuit applications as tuned r-f power amplifiers.

Disadvantages of Grounded-Cathode Amplifiers An undesirable aspect of the operation of cathode-return r-f power amplifiers using triode tubes is that

such amplifiers must be neutralized. Principles and methods of neutralizing r-f power amplifiers are discussed in the chapter *Generation of R-F Energy*. As the frequency of operation of an amplifier is increased the stage becomes more and more difficult to neutralize due to inductance in the grid and plate leads of the tubes and in the leads to the neutralizing capacitors. In other words the bandwidth of neutralization decreases as the frequency is increased. In addition the very presence of the neutralizing capacitors adds additional undesirable capacitive loading to the grid and plate tank circuits of the tube or tubes. To look at the problem in another way, an amplifier that may be perfectly neutralized at a frequency of 30 Mc. may be completely out of neutralization at a frequency of 120 Mc. Therefore, if there are circuits in both the grid and plate circuits which offer appreciable impedance at this high frequency it is quite possible that the stage may develop a "parasitic oscillation" in the vicinity of 120 Mc.

Grounded-Grid R-F Amplifiers This condition of restricted-range neutralization of r-f power amplifiers can be greatly alleviated through the use of a cathode-return or grounded-grid r-f stage. The grounded-grid amplifier has the following advantages:

- The output capacitance of a stage is reduced to approximately one-half the value which would be obtained if the same tube or tubes were operated as a conventional neutralized amplifier.
- The tendency toward parasitic oscillations in such a stage is greatly reduced since the shielding effect of the control grid be-

tween the filament and the plate is effective over a broad range of frequencies.

3. The feedback capacitance within the stage is the plate-to-cathode capacitance which is ordinarily very much less than the grid-to-plate capacitance. Hence neutralization is ordinarily not required. If neutralization is required the neutralizing capacitors are very small in value and are cross connected between plates and cathodes in a push-pull stage, or between the opposite end of a split plate tank and the cathode in a single-ended stage.

The disadvantages of a grounded-grid amplifier are:

1. A large amount of excitation energy is required. However, only the normal amount of energy is lost in the grid circuit of the amplifier tube; all additional energy over this amount is delivered to the load circuit as useful output.
2. The cathode of a grounded-grid amplifier stage is "hot" to r.f. This means that the cathode must be fed through a suitable impedance from the filament supply, or the secondary of the filament transformer must be of the low-capacitance type and adequately insulated for the r-f voltage which will be present.
3. A grounded-grid r-f amplifier cannot be plate modulated 100 per cent unless the output of the exciting stage is modulated also. Approximately 70 per cent modulation of the exciter stage as the final stage is being modulated 100 per cent is recommended. However, the grounded-grid r-f amplifier is quite satisfactory as a Class B linear r-f amplifier for single sideband or conventional amplitude modulated waves or as an amplifier for a straight c-w or FM signal.

Figure 9 shows a simplified representation of a grounded-grid triode r-f power amplifier stage. The relationships between input and output power and the peak fundamental components of electrode voltages and currents are given below the drawing. The calculation of the complete operating conditions for a grounded-grid amplifier stage is somewhat more complex than that for a conventional amplifier because the input circuit of the tube is in series with the output circuit as far as the load is concerned. The primary result of this effect is, as stated before, that considerably more power is required from the driver stage. The normal power gain for a g-g stage is from 3 to 15 depending upon the grid circuit conditions chosen for the output stage. The higher the grid bias and grid swing required on the

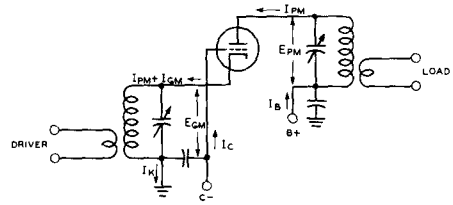

$$\text{POWER OUTPUT TO LOAD} = \frac{(E_{GM} + E_{PM}) I_{PM}}{2} \text{ OR } \frac{E_{PM} I_{PM}}{2} + \frac{E_{GM} I_{PM}}{2}$$

$$\text{POWER DELIVERED BY OUTPUT TUBE} = \frac{E_{PM} I_{PM}}{2}$$

$$\text{POWER FROM DRIVER TO LOAD} = \frac{E_{GM} I_{PM}}{2}$$

$$\text{TOTAL POWER DELIVERED BY DRIVER} = \frac{E_{GM} (I_{PM} + I_{GM})}{2}$$

$$\text{OR } \frac{E_{GM} I_{PM}}{2} + 0.9 E_{GM} I_C$$

$$\text{POWER ABSORBED BY OUTPUT TUBE GRID AND BIAS SUPPLY:}$$

$$= \frac{E_{GM} I_{GM}}{2} \text{ OR } 0.9 E_{GM} I_C$$

$$Z_K \text{ (APPROXIMATELY)} = \frac{E_{GM}}{I_{PM} + 1.8 I_C}$$

Figure 9
GROUNDED-GRID CLASS B OR CLASS C AMPLIFIER

The equations in the above figure give the relationships between the fundamental components of grid and plate potential and current, and the power input and power output of the stage. An expression for the approximate cathode impedance is given

output stage, the higher will be the requirement from the driver.

Calculation of Operating Conditions of Grounded Grid R-F Amplifiers It is most convenient to determine the operating conditions for a Class B or Class C

grounded-grid r-f power amplifier in a two-step process. The first step is to determine the plate-circuit and grid-circuit operating conditions of the tube as though it were to operate as a conventional cathode-return amplifier stage. The second step is then to add in the additional conditions imposed upon the operating conditions by the fact that the stage is to operate as a grounded-grid amplifier.

For the first step in the calculation the procedure given in Section 8-3 is quite satisfactory and will be used in the example to follow. Suppose we take for our example the case of a type 304TL tube operating at 2700 plate volts at a kilowatt input. Following through the procedure previously given:

1. Desired power output—850 watts
Desired Plate voltage—2700 volts
Desired plate efficiency—85 per cent
($N_p = 0.85$)

2. $P_{in} = 850/0.85 = 1000$ watts
3. $P_p = 1000 - 850 = 150$ watts
Type 304TL chosen; max. $P_p = 300$ watts, $\mu = 12$.
4. $I_b = 1000/2700 = 0.370$ ampere
(370 ma.)
5. Approximate $i_{pmax} = 4.9 \times 0.370 = 1.81$ ampere
6. $e_{pmin} = 140$ volts (from 304TL constant-current curves)
7. $E_{pm} = 2700 - 140 = 2560$ volts
8. $I_{pm}/I_b = 2 \times 0.85 \times 2700/2560 = 1.79$
9. $i_{pmax}/I_b = 4.65$ (from figure 3)
10. $i_{pmax} = 4.65 \times 0.370 = 1.72$ amperes
11. $e_{gmp} = 140$ volts
 $i_{gmax} = 0.480$ amperes
12. $\cos \theta_p = 2.32 (1.79 - 1.57) = 0.51$
 $\theta_p = 59^\circ$
13. $E_{cc} = \frac{1}{1 - 0.51} \times \left[0.51 \left(\frac{2560}{12} - 140 \right) - \frac{2700}{12} \right]$
 $= -385$ volts
14. $E_{gm} = 140 - (-385) = 525$ volts
15. $E_{gm}/E_{cc} = -1.36$
16. $i_{gmax}/I_c = \text{approx. } 8.25$ (extrapolated from figure 4)
17. $I_c = 0.480/8.25 = 0.058$ (58 ma. d-c grid current)
18. $P_d = 0.9 \times 525 \times 0.058 = 27.5$ watts
19. $P_g = 27.5 - (-385 \times 0.058) = 5.2$ watts
Max. P_g for 304TL is 50 watts

We can check the operating plate efficiency of the stage by the method described in Section 8-4 as follows:

$$F_1 = E_{pm}/E_{bb} = 2560/2700 = 0.95$$

$$F_2 \text{ for } \theta_p \text{ of } 59^\circ \text{ (from figure 6)} = 0.90$$

$$N_p = F_1 \times F_2 = 0.95 \times 0.90 = \text{Approx. } 0.85 \text{ (85 per cent plate efficiency)}$$

Now, to determine the operating conditions as a grounded-grid amplifier we must also know the peak value of the fundamental components of plate current. This is simply equal to $(I_{pm}/I_b) I_b$, or:

$$I_{pm} = 1.79 \times 0.370 = 0.660 \text{ amperes (from 4 and 8 above)}$$

The total average power required of the driver (from figure 9) is equal to $E_{gm} I_{pm}/2$ (since the grid is grounded and the grid swing appears also as cathode swing) plus P_d which is 27.5 watts from 18 above. The total is:

$$\text{Total drive} = \frac{525 \times 0.660}{2} = 172.5 \text{ watts}$$

plus 27.5 watts or 200 watts

Therefore the total power output of the stage is equal to 850 watts (contributed by the 304TL) plus 172.5 watts (contributed by the driver) or 1022.5 watts. The cathode driving impedance of the 304TL (again referring to figure 7) is approximately:

$$Z_k = 525/(0.660 + 0.116) = \text{approximately } 675 \text{ ohms.}$$

Plate-Return or Cathode-Follower R-F Power Amplifier Circuit diagram, electrode potentials and currents, and operating conditions for a cathode-follower r-f power amplifier are given in figure 10. This circuit can be used, in addition to the grounded-grid circuit just discussed, as an r-f amplifier with a triode tube and no additional neutralization circuit. However, the circuit will oscillate if the impedance from cathode to ground is allowed to become capacitive rather than inductive or resistive with respect to the operating frequency. The circuit is not recommended except for v-h-f or u-h-f work with coaxial lines as tuned circuits since the peak grid swing required on the r-f amplifier stage is approximately equal to the plate voltage on the amplifier tube if high-efficiency operation is desired. This means, of course, that the grid tank must be able to withstand slightly more peak voltage than the plate tank. Such a stage may not be plate modulated unless the driver stage is modulated the same percentage as the final amplifier. However, such a stage may be used as an amplifier or modulated waves (Class B linear) or as a c-w or FM amplifier.

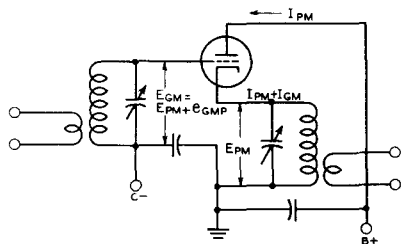

POWER OUTPUT TO LOAD = $\frac{E_{PM} (I_{PM} + I_{GM})}{2}$

POWER DELIVERED BY OUTPUT TUBE = $\frac{E_{PM} I_{PM}}{2}$

POWER FROM DRIVER TO LOAD = $\frac{E_{PM} I_{GM}}{2}$

TOTAL POWER FROM DRIVER = $\frac{E_{GM} I_{GM}}{2} = \frac{(E_{PM} + E_{GMP}) I_{GM}}{2}$
 = APPROX. $\frac{(E_{PM} + E_{GMP}) 1.8 I_C}{2}$
 ASSUMING $I_{GM} \approx 1.8 I_C$

POWER ABSORBED BY OUTPUT TUBE GRID AND BIAS SUPPLY:
 = APPROX. $0.9 (E_{CC} + E_{GMP}) I_C$

$Z_G = \frac{E_{GM}}{I_{GM}} = \text{APPROX. } \frac{(E_{PM} + E_{GMP})}{1.8 I_C}$

Figure 10
CATHODE-FOLLOWER R-F POWER AMPLIFIER

Showing the relationships between the tube potentials and currents and the input and output power of the stage. The approximate grid impedance also is given.

The design of such an amplifier stage is essentially the same as the design of a grounded-grid amplifier stage as far as the first step is concerned. Then, for the second step the operating conditions given in figure 10 are applied to the data obtained in the first step. As an example, take the 304TL stage previously described. The total power required of the driver will be (from figure 10) approximately $(2700 \times 0.58 \times 1.8) / 2$ or 141 watts. Of this 141 watts 27.5 watts (as before) will be lost as grid dissipation and bias loss and the balance of 113.5 watts will appear as output. The total output of the stage will then be approximately 963 watts.

Cathode Tank for G-G or C-F Power Amplifier The cathode tank circuit for either a grounded-grid or cathode-follower r-f power amplifier may be a conventional tank circuit if the filament transformer for the stage is of the low-capacitance high-voltage type. Conventional filament transformers, however, will not operate with the high values of r-f voltage present in such a

circuit. If a conventional filament transformer is to be used the cathode tank coil may consist of two parallel heavy conductors (to carry the high filament current) by-passed at both the ground end and at the tube socket. The tuning capacitor is then placed between filament and ground. It is possible in certain cases to use two r-f chokes of special design to feed the filament current to the tubes, with a conventional tank circuit between filament and ground. Coaxial lines also may be used to serve both as cathode tank and filament feed to the tubes for v-h-f and u-h-f work.

8-6 **A Grounded-Grid 304TL Amplifier**

The 304TL tube is capable of operating as an r-f amplifier of the conventional type with the full kilowatt input permitted amateur stations. The tube is characterized by an enormous reserve of filament emission, resulting from the fact that about 130 watts is required merely to light the four filaments. Where the heavy filament drain, plus the low amplification factor of about 12, does not impose hardship in the design of the transmitter, the 304TL is quite satisfactory for amateur service.

The 304TL offers an additional feature in that its plate-to-cathode capacitance is very low (about $0.6 \mu\mu\text{fd.}$) for a tube of its size and power handling capabilities. This feature permits the tube to be operated, without neutralization, as a grounded-grid r-f power amplifier.

Characteristics of Grounded-Grid Operation Although the excitation power of the tube is only 27.5 watts (which would be the actual driving power required if the tube were operating as a neutralized amplifier) the driving power required into the cathode circuit from the exciter is about 200 watts. The extra 170 watts or so is not lost, however, since it appears directly in the output of the amplifier as additional energy. Thus while the 304TL itself will deliver about 850 watts to the load circuit, the extra 170 watts supplied by the driver over and above the 27.5 watts required to excite the 304TL appears added to the 850-watt output of the 304TL. Thus the total output of the stage would be about 1020 watts, even though the d-c input to the 304TL was only one kilowatt. Nevertheless, the tube itself operates only at its normal plate-circuit efficiency, the extra power output coming directly from the added excitation power taken from the driver.

should have a reactance of 70 ohms. This value of reactance is represented by about 550 μfd . at 4 Mc., and proportionately smaller capacitances for higher frequencies. Since the peak cathode voltage is only about 400, quite small spacing in the cathode tank capacitor can be used.

Figure 11 illustrates a practical grounded-grid amplifier, using a single 304TL tube. A bifilar wound coil is used to feed the filament voltage to the tube. Shunting inductors are used to tune the filament circuit to higher frequencies. When tuning the g-g stage, it must be remembered that the input tuned circuit is effectively in series with the output circuit as far as the output energy is concerned. Thus, it is not possible to apply full excitation power to the stage unless plate current is also flowing. If full excitation is applied in the absence of plate voltage, the grid of the output tube would be damaged from excessive excitation. Construction of the amplifier is illustrated in figures 12 and 13.

A 3000-volt plate supply is used which should have good regulation. An output filter condenser of at least 10 microfarads should be employed for Class B operation. Class B operating bias is -260 volts, obtained from a well regulated bias supply.

For operation in TV areas, additional lead filtering is required, as well as complete screening of the amplifier.

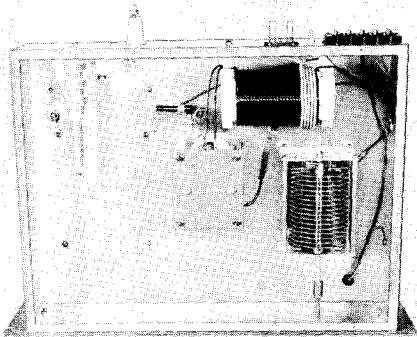

Figure 13
UNDERSIDE OF THE GROUNDED-GRID
AMPLIFIER

8-7 Class AB1 Radio Frequency Power Amplifiers

Class AB1 r-f amplifiers operate under such conditions of bias and excitation that grid current does not flow over any portion of the input cycle. This is desirable, since distortion caused by grid current loading is absent, and also because the stage is capable of high power gain. Stage efficiency is about 58% when a plate current operating angle of 210° is chosen, as compared to 62% for Class B operation.

The level of static (quiescent) plate current for *lowest distortion* is quite critical for Class AB1 tetrode operation. This value is determined by the tube characteristics, and is not greatly affected by the circuit parameters or operating voltages. The maximum d-c plate potential is therefore limited by the static dissipation of the tube, since the resting plate current figure is fixed. The static plate current of a tetrode tube varies as the $3/2$ power of the screen voltage. For example, raising the screen voltage from 300 to 500 volts will double the plate current. The optimum static plate current for minimum distortion is also doubled, since the shape of the Eg- I_p curve does not change.

In actual practice, somewhat lower static plate current than optimum may be employed without raising the distortion appreciably, and values of static plate current of 0.6 to 0.8 of optimum may be safely used, depending upon the amount of nonlinearity that can be tolerated.

As with the class B linear stage, the minimum plate voltage swing of the class AB1 amplifier must be kept above the d-c screen potential to prevent operation in the nonlinear portion of the characteristic curve. A *low value* of screen voltage allows greater r-f plate voltage swing, resulting in improvement in plate efficiency of the tube. A balance between plate dissipation, plate efficiency, and plate voltage swing must be achieved for best linearity of the amplifier.

The S-Curve The perfect linear amplifier delivers a signal that is a replica of the input signal. Inspection of the plate characteristic curve of a typical tube will disclose the tube linearity under class A operating conditions (figure 14). The curve is usually of exponential shape, and the signal distortion is held to a small value by operating the tube well below its maximum output, and centering operation over the most linear portion of the characteristic curve.

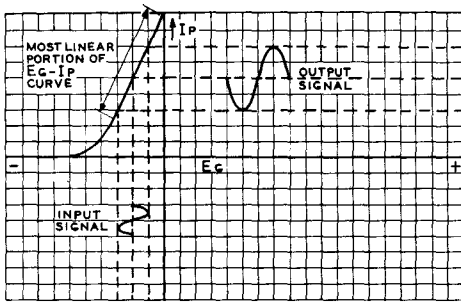

Figure 14
Eg-Ip CURVE

Amplifier operation is confined to most linear portion of characteristic curve.

The relationship between exciting voltage in a Class AB1 amplifier and the r-f plate circuit voltage is shown in figure 15. With a small value of static plate current the lower portion of the line is curved. Maximum undistorted output is limited by the point on the line (A) where the instantaneous plate voltage down to the screen voltage. This "hook" in the line is caused by current diverted from the plate to the grid and screen elements of the tube. The characteristic plot of the usual linear amplifier takes the shape of an S-curve. The lower portion of the curve is straightened out by using the proper value of static plate current, and the upper portion of the curve is avoided by limiting minimum plate voltage swing to a point substantially above the value of the screen voltage.

Operating Parameters for the Class AB1 Linear Amplifier The approximate operating parameters may be obtained from the Constant Current curves (E_g-I_p) or the E_g-I_p curves of the tube in question. An operating load line is first approximated. One end of the load line is determined by the d-c operating voltage of the tube, and the required static plate current. As a starting point, let the product of the plate voltage and current equal the plate dissipation of the tube. Assuming we have a 4-400A tetrode, this end of the load line will fall on point A (figure 16). Plate power dissipation is 360 watts (3000V @ 120 ma). The opposite end of the load line will fall on a point determined by the minimum instantaneous plate voltage, and by the maximum instantaneous plate current. The minimum plate voltage, for best linearity should be considerably higher than

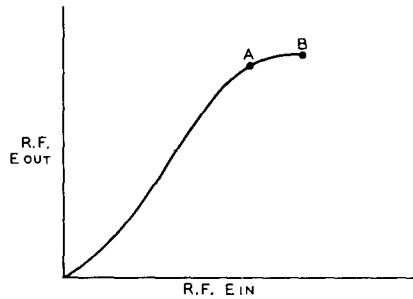

Figure 15
LINEARITY CURVE OF TYPICAL TETRODE AMPLIFIER

At point "A" the instantaneous plate voltage is swinging down to the value of screen voltage. At point "B" it is swinging well below the screen and is approaching the point where saturation, or plate current limiting takes place.

the screen voltage. In this case, the screen voltage is 500, so the minimum plate voltage excursion should be limited to 600 volts. Class AB1 operation implies no grid current, therefore the load line cannot cross the $E_g=0$ line. At the point $E_p=600$, $E_g=0$, the maximum plate current is 580 ma (Point "B").

Each point the load line crosses a grid voltage axis may be taken as a point for construction of the E_g-I_p curve, just as was done in figure 22, chapter 6. A constructed curve shows that the approximate static bias voltage is -74 volts, which checks closely with point A of figure 16. In actual practice, the bias voltage is set to hold the actual dissipation slightly below the maximum figure of the tube.

The single tone power output is:

$$\frac{E_{max}-E_{min} \times I_{pmax}}{4}, \text{ or } \frac{3000-600}{4} \times .58 = 348 \text{ watts}$$

The plate current-angle efficiency factor for this class of operation is 0.73, and the actual plate circuit efficiency is:

$$N_p = \frac{E_{max}-E_{min}}{E_{max}} \times 0.73, \text{ or } \frac{3000-600}{3000} \times 0.73 = 58.4\%$$

The power input to the stage is therefore

$$\frac{P_o}{N_p} \times 100 \text{ or, } \frac{348}{58.4} = 595 \text{ watts}$$

The plate dissipation is: $595-348=247$ watts.

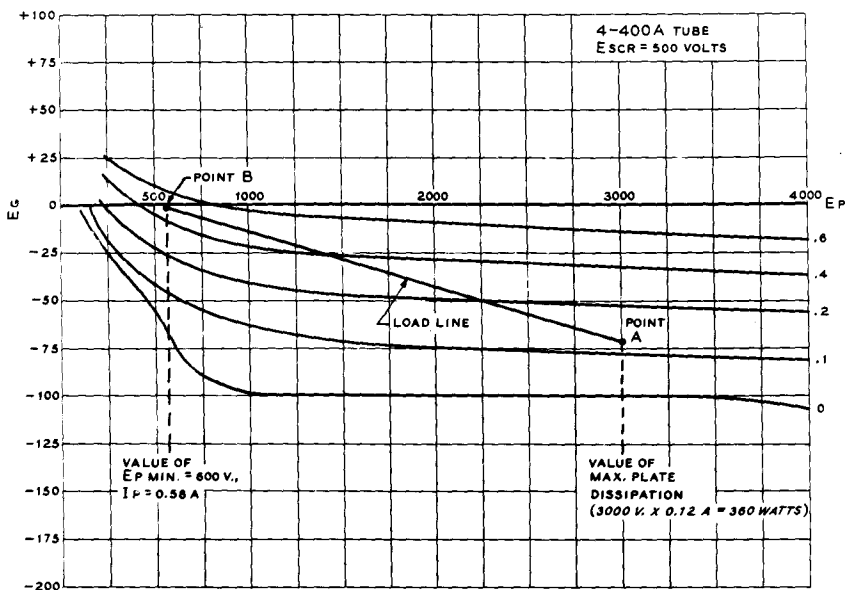

Figure 16
OPERATING PARAMETERS FOR TETRODE LINEAR
AMPLIFIER ARE OBTAINED FROM CONSTANT-CURRENT
CURVES.

It can be seen that the limiting factor for this class of operation is the static plate dissipation, which is quite a bit higher than the operating dissipation level. It is possible, at the expense of a higher level of distortion, to drop the static plate dissipation and to increase the screen voltage to obtain greater power output. If the screen voltage is set at 800, and the bias increased sufficiently to drop the static plate current to 90 ma, the single tone d-c plate current may rise to 300 ma, for a power input of 900 watts. The plate circuit efficiency is 55.6%, and the power output is 500 watts. Static plate dissipation is 270 watts.

At a screen potential of 500 volts, the maximum screen current is less than 1 ma, and under certain loading conditions may be negative. When the screen potential is raised to 800 volts maximum screen current is 18 ma. The performance of the tube depends upon the voltage fields set up within the tube by the cathode, control grid, screen grid, and plate. The quantity of current flowing in the screen circuit is only incidental to the fact that the screen is maintained at a positive potential with respect to the electron stream surrounding it.

The tube will perform as expected so long as the screen current, in either direction, does not create undesirable changes in the screen voltage, or cause excessive screen dissipation. Good regulation of the screen supply is there-

fore required. Screen dissipation is highly responsive to plate loading conditions, and the plate circuit should always be adjusted so as to keep the screen current below the maximum dissipation level as established by the applied voltage.

G-G Class B Linear Tetrode Amplifier Certain tetrode and pentode tubes, such as the 6AG7, 837, and 803 perform well as grounded grid class B linear amplifiers. In this configuration both grids and the suppressor are grounded, and excitation is applied to the cathode circuit of the tube. So connected, the tubes take on characteristics of high- μ triodes. No bias or screen supplies are required for this type of operation, and reasonably linear

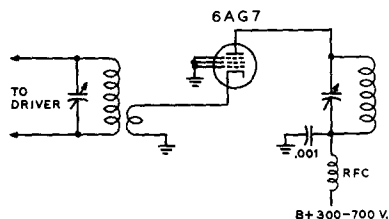

Figure 17
SIMPLE GROUNDED-GRID
LINEAR AMPLIFIER

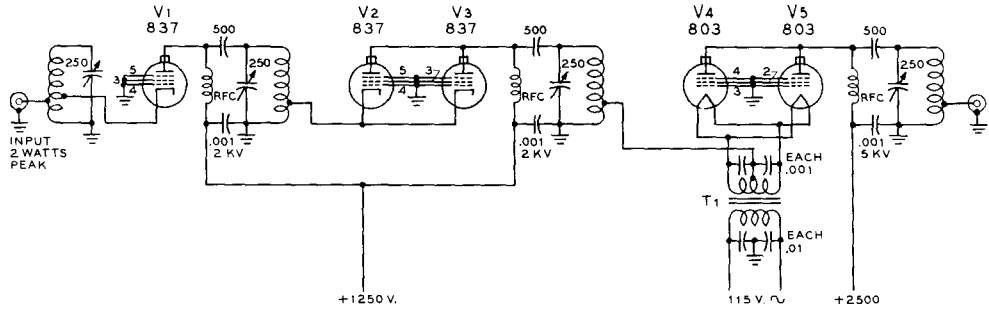

Figure 18
3-STAGE KILOWATT LINEAR
AMPLIFIER FOR 80 OR 40
METER OPERATION

An open frame filament transformer may be used for T1. Cathode taps are adjusted for proper excitation of following stage.

operation can be had with a very minimum of circuit components (figure 17). The input impedance of the g-g stage falls between 100 and 250 ohms, eliminating the necessity of swamping resistors, even though considerable power is drawn by the cathode circuit of the g-g stage.

Power gain of a g-g stage varies from approximately 20 when tubes of the 6AG7 type are used, down to five or six for the 837 and 803 tubes. One or more g-g stages may be cascaded to provide up to a kilowatt of power, as illustrated in figure 18.

The input and output circuits of cascaded g-g stages are in series, and a variation in load impedance of the output stage reflects back as a proportional change on the input circuit. If the first g-g stage is driven by a high impedance source, such as a tetrode amplifier, any change in gain will automatically be compensated for. If the gain of V4-V5 drops, the input impedance to that stage will rise. This change will reflect through V2-V3 so that the load impedance of V1 rises. Since V1 has a high internal impedance the output voltage will rise when the load impedance rises. The increased output voltage will raise the output voltage of each g-g stage so that the overall output is nearly up to the initial value before the drop in gain of V4-V5.

The tank circuits, therefore, of all g-g stages must be resonated with low plate voltage and excitation applied to the tubes. Tuning of one stage will affect the other stages, and the input and coupling of each stage must be adjusted in turn until the proper power limit is reached.

using a 4-400A tube for the h.f. region. The operating characteristics of the amplifier are summarized in figure 19. It can be noted that unusually low screen voltage is used on the tube. The use of lower screen voltage has the adverse effect of increasing the driving power, but at the same time the static plate current of the stage is decreased and linearity is improved. For grounded grid operation of the 4-400A, a screen voltage of 300 volts (filament to screen) gives a reasonable compromise between these factors.

Operating Data for
4-400A Grounded
Grid Linear
Amplifier

Experiments have been conducted by Collins Radio Co. on a grounded grid linear amplifier stage

OPERATING DATA FOR 4-400A/4-250A G-G. LINEAR AB ₁ AMPLIFIER (SINGLE TONE)		
D-C SCREEN VOLTAGE	+300	+300
D-C PLATE VOLTAGE	+3000	+3500
STATIC PLATE CURRENT	60 MA.	60 MA.
D-C GRID BIAS	-60 V.	-59 V.
PEAK CATHODE SWING	87 V.	113 V.
MINIMUM PLATE VOLTAGE	660 V.	500 V.
MAXIMUM SIGNAL GRID CURRENT	3.6 MA.	10 MA.
MAXIMUM SIGNAL SCREEN CURRENT	4.1 MA.	20 MA.
MAXIMUM SIGNAL PLATE CURRENT	195 MA.	267 MA.
MAXIMUM SIGNAL PLATE DISSIPATION	235 W.	235 W.
STATIC PLATE DISSIPATION	180 W.	210 W.
GRID DRIVING POWER	0.63 W.	3.4 W.
FEEDTHRU POWER	6.55 W.	15.8 W.
POWER OUTPUT (MAXIMUM)	350 W.	700 W.
POWER INPUT (MAXIMUM)	565 W.	935 W.

Figure 19

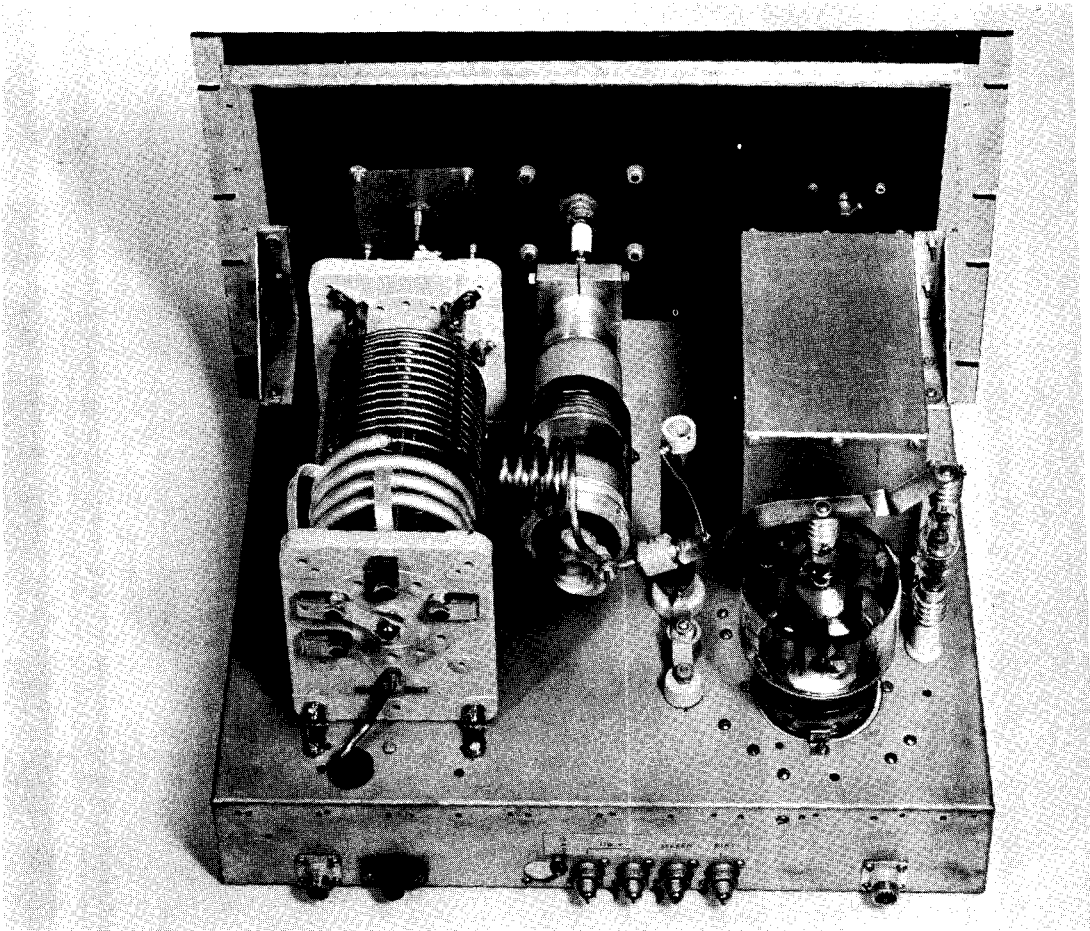

TOP VIEW OF A 4-250A AMPLIFIER

Pi-network tetrode amplifier may be operated Class AB₁, Class B, or Class C by varying various potentials applied to tube. Some general physical and mechanical design applies in each case.

The Oscilloscope

The cathode-ray oscilloscope (also called oscillograph) is an instrument which permits visual examination of various electrical phenomena of interest to the electronic engineer. Instantaneous changes in voltage, current and phase are observable if they take place slowly enough for the eye to follow, or if they are periodic for a long enough time so that the eye can obtain an impression from the screen of the cathode-ray tube. In addition, the cathode-ray oscilloscope may be used to study any variable (within the limits of its frequency response characteristic) which can be converted into electrical potentials. This conversion is made possible by the use of some type of *transducer*, such as a vibration pickup unit, pressure pickup unit, photoelectric cell, microphone, or a variable impedance. The use of such a transducer makes the oscilloscope a valuable tool in fields other than electronics.

the recipient of signals from two sources: the vertical and horizontal amplifiers. The operation of the cathode-ray tube itself has been covered in Chapter 4; the auxiliary circuits pertaining to the cathode-ray tube will be covered here.

The Vertical Amplifier The incoming signal which is to be examined is applied to the terminals marked *Vertical Input* and *Ground*. The *Vertical Input* terminal is connected through capacitor C_1 (figure 2) so that the a-c component of the input signal appears across the vertical amplifier gain control potentiometer, R_1 . Thus the magnitude of the incoming signal may be controlled to provide the desired deflection on the screen of

9-1 A Typical Cathode-Ray Oscilloscope

For the purpose of analysis, the operation of a simple oscilloscope will be described. The Du Mont type 274-A unit is a fit instrument for such a description. The block diagram of the 274-A is shown in figure 1. The electron beam of the cathode-ray tube can be moved vertically or horizontally, or the vertical and horizontal movements may be combined to produce composite patterns on the tube screen. As shown in figure 1, the cathode-ray tube is

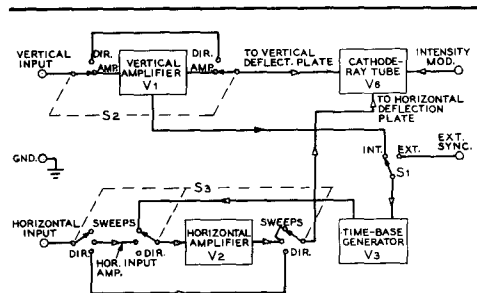

Figure 1
BLOCK DIAGRAM, TYPE 274-A
CATHODE-RAY OSCILLOSCOPE

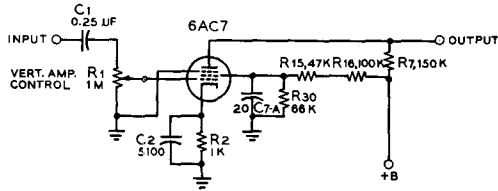

Figure 2
TYPICAL AMPLIFIER SCHEMATIC

the cathode-ray tube. Also, as shown in figure 1, S_2 has been incorporated to by-pass the vertical amplifier and capacitively couple the input signal directly to the vertical deflection plate if so desired.

In figure 2, V_1 is a 6AC7 pentode tube which is used as the vertical amplifier. As the signal variations appear on the grid of V_1 , variations in the plate current of V_1 will take place. Thus signal variations will appear in opposite phase and greatly amplified across the plate resistor, R_7 . Capacitor C_2 has been added across R_2 in the cathode circuit of V_1 to flatten the frequency response of the amplifier at the high frequencies. This capacitor because of its low value has very little effect at low input frequencies, but operates more effectively as the frequency of the signal increases. The amplified signal delivered by V_1 is now applied through the second half of switch S_2 and capacitor C_4 to the free vertical deflection plate of the cathode-ray tube (figure 3).

The Horizontal Amplifier The circuit of the horizontal amplifier and the circuit of the vertical amplifier, described in the above paragraph, are similar. A switch in the input circuit makes provision for the input from the *Horizontal Input* terminals to be capacitively coupled to the grid of the horizontal amplifier or to the free horizontal deflection plate thus by-passing the amplifier, or for the output of the sweep generator to be capacitively coupled to the amplifier, as shown in figure 1.

The Time Base Generator Investigation of electrical wave forms by the use of a cathode-ray tube frequently requires that some means be readily available to determine the variation in these wave forms with respect to time. When such a time base is required, the patterns presented on the cathode-ray tube screen show the variation in amplitude of the input signal with respect to

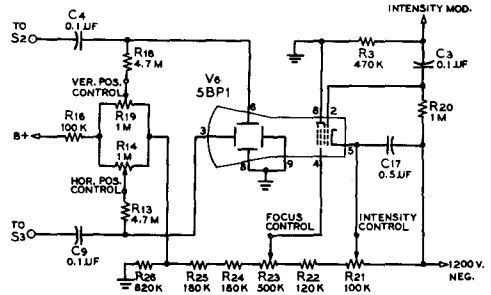

Figure 3
SCHEMATIC OF CATHODE-RAY TUBE CIRCUITS

A 5BP1A cathode-ray tube is used in this instrument. As shown, the necessary potentials for operating this tube are obtained from a voltage divider made up of resistors R_{21} through R_{26} inclusive. The intensity of the beam is adjusted by moving the contact on R_{21} . This adjusts the potential on the cathode more or less negative with respect to the grid which is operated at the full negative voltage—1200 volts. Focusing is the desired sharpness is accomplished by adjusting the contact on R_{23} to provide the correct potential for anode no. 1. Interdependency between the focus and the intensity controls is inherent in all electrostatically focused cathode-ray tubes. In short, there is an optimum setting of the focus control for every setting of the intensity control. The second anode of the 5BP1A is operated at ground potential in this instrument. Also one of each pair of deflection plates is operated at ground potential.

The cathode is operated at a high negative potential (approximately 1200 volts) so that the total overall accelerating voltage of this tube is regarded as 1200 volts since the second anode is operated at ground potential. The vertical and horizontal positioning controls which are connected to their respective deflection plates are capable of supplying either a positive or negative d-c potential to the deflection plates. This permits the spot to be positioned at any desired place on the entire screen.

time. Such an arrangement is made possible by the inclusion in the oscilloscope of a *Time Base-Generator*. The function of this generator is to move the spot across the screen at a constant rate from left to right between two selected points, to return the spot almost instantaneously to its original position, and to



Figure 4
SAWTOOTH WAVE FORM

repeat this procedure at a specified rate. This action is accomplished by the voltage output from the time base (sweep) generator. The rate at which this voltage repeats the cycle of sweeping the spot across the screen is referred to as the *sweep frequency*. The sweep voltage necessary to produce the motion described above must be of a sawtooth wave-form, such as that shown in figure 4.

The sweep occurs as the voltage varies from A to B, and the *return trace* as the voltage varies from B to C. If A-B is a straight line, the sweep generated by this voltage will be linear. It should be realized that the sawtooth sweep signal is only used to plot variations in the vertical axis signal with respect to time. Specialized studies have made necessary the use of sweep signals of various shapes which are introduced from an external source through the Horizontal Input terminals.

The Sawtooth Generator The sawtooth voltage necessary to obtain the linear time base is generated by the circuit of figure 5, which operates as follows:

A type 884 gas triode (V_3) is used for the sweep generator tube. This tube contains an inert gas which ionizes when the voltage between the cathode and the plate reaches a certain value. The ionizing voltage depends upon the bias voltage of the tube, which is determined by the voltage divider resistors R_{12} - R_{17} . With a specific negative bias applied to the

884 tube, the tube will ionize (or fire) at a specific plate voltage.

Capacitors C_{10} - C_{14} are selectively connected in parallel with the 884 tube. Resistor R_{11} limits the peak current drain of the gas triode. The plate voltage on this tube is obtained through resistors R_{28} , R_{27} and R_{11} . The voltage applied to the plate of the 884 tube cannot reach the power supply voltage because of the charging effect this voltage has upon the capacitor which is connected across the tube. This capacitor charges until the plate voltage becomes high enough to ionize the gas in the tube. At this time, the 884 tube starts to conduct and the capacitor discharges through the tube until its voltage falls to the extinction potential of the tube. When the tube stops conducting, the capacitor voltage builds up until the tube fires again. As this action continues, it results in the sawtooth wave form of figure 4 appearing at the junction of R_{11} and R_{27} .

Synchronization Provision has been made so the sweep generator may be synchronized from the vertical amplifier or from an external source. The switch S_1 shown in figure 5 is mounted on the front panel to be easily accessible to the operator.

If no synchronizing voltage is applied, the discharge tube will begin to conduct when the plate potential reaches the value of E_f (Firing Potential). When this breakdown takes place and the tube begins to conduct, the capacitor is discharged rapidly through the tube, and the plate voltage decreases until it reaches the extinction potential E_x . At this point conduction ceases, and the plate potential rises slowly as the capacitor begins to charge through R_{27} and R_{28} . The plate potential will again reach a point of conduction and the circuit will start a new cycle. The rapidity of the plate voltage rise is dependent upon the circuit constants R_{27} , R_{28} , and the capacitor selected,

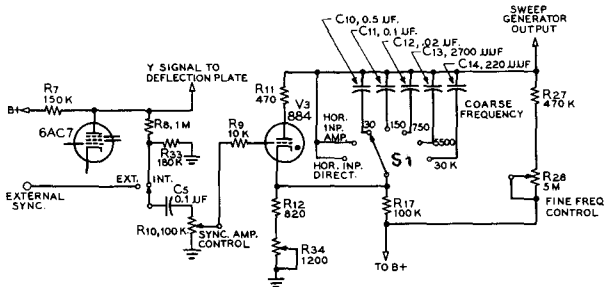

Figure 5
SCHEMATIC OF SWEEP GENERATOR

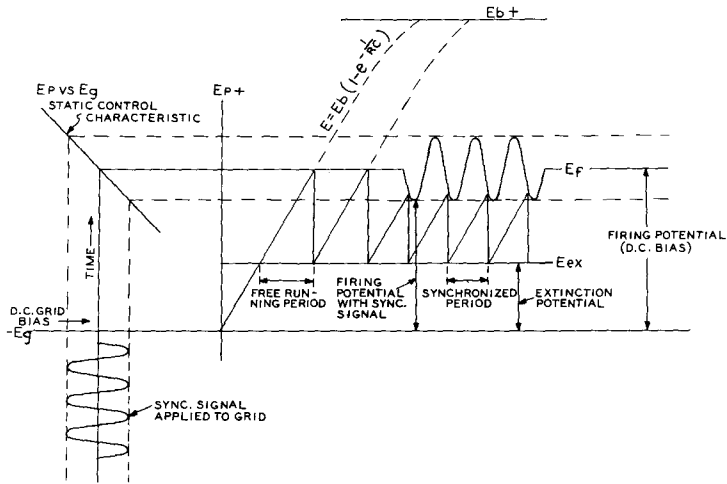

Figure 6
ANALYSIS OF SYNCHRONIZATION OF TIME-BASE GENERATOR

C10-C14, as well as the supply voltage E_b . The exact relationship is given by:

$$E_c = E_b \left(1 - e^{-\frac{t}{rc}} \right)$$

- Where E_c = Capacitor voltage at time t
- E_b = Supply voltage (B+ supply - cathode bias)
- E_f = Firing potential or potential at which time-base gas triode fires
- E_x = Extinction potential or potential at which time-base gas triode ceases to conduct
- e = Base of natural logarithms
- t = Time in seconds
- r = Resistance in ohms ($R_{27} + R_{28}$)
- c = Capacity in farads ($C_{10}, 11, 12, 13, \text{ or } 14$)

The frequency of oscillation will be approximately:

$$f = \frac{E_b}{rc(E_f - E_x)}$$

Under this condition (no synchronizing signal applied) the oscillator is said to be *free running*.

When a positive synchronizing voltage is applied to the grid, the firing potential of the tube is reduced. The tube therefore ionizes at a lower plate potential than when no grid signal is applied. Thus the applied synchronizing voltage fires the gas-filled triode each

time the plate potential rises to a sufficient value, so that the sweep recurs at the same or an integral sub-multiple of the synchronizing signal rate. This is illustrated in figure 6.

Power Supply Figure 7 shows the power supply to be made up of two definite sections: a low voltage positive supply which provides power for operating the amplifiers, the sweep generator, and the positioning circuits of the cathode-ray tube; and the high voltage negative supply which provides the potentials necessary for operating the various

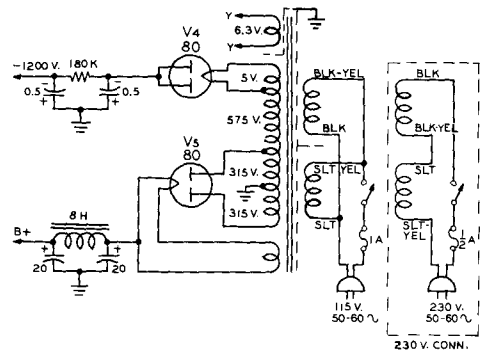

Figure 7
SCHEMATIC OF POWER SUPPLY

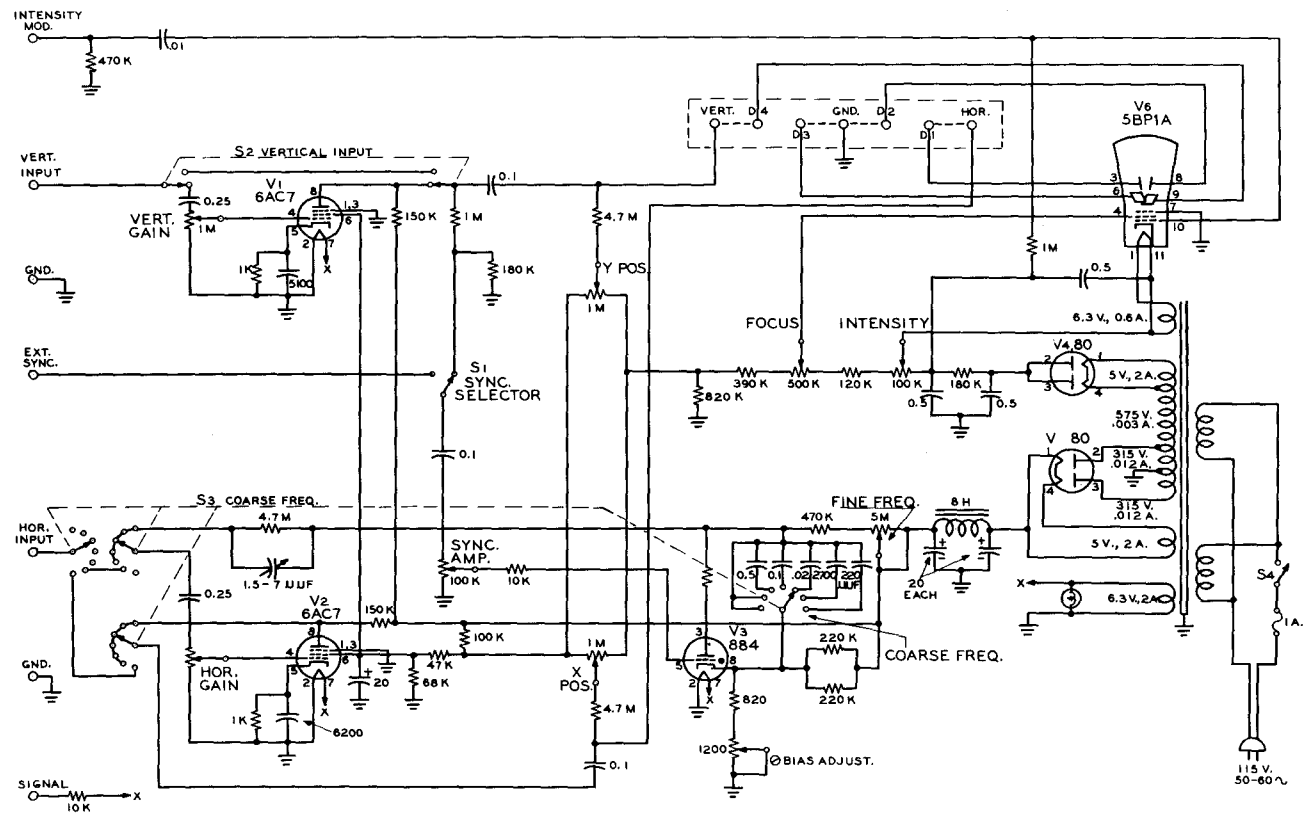

Figure 8

CIRCUIT OF TYPE 274-A CATHODE-RAY OSCILLOSCOPE

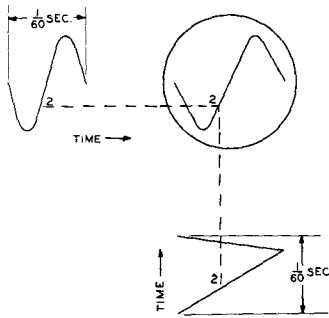

Figure 9

PROJECTION DRAWING OF A SINEWAVE APPLIED TO THE VERTICAL AXIS AND A SAWTOOTH WAVE OF THE SAME FREQUENCY APPLIED SIMULTANEOUSLY ON THE HORIZONTAL AXIS

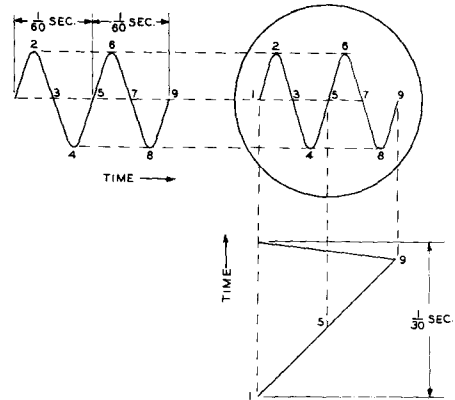

Figure 10

PROJECTION DRAWING SHOWING THE RESULTANT PATTERN WHEN THE FREQUENCY OF THE SAWTOOTH IS ONE-HALF OF THAT EMPLOYED IN FIGURE 9

electrodes of the cathode-ray tube, and for certain positioning controls.

The positive low voltage supply consists of full-wave rectifier (V_5), the output of which is filtered by a capacitor input filter (20-20 μ fd. and 8 H). It furnishes approximately 400 volts. The high voltage power supply employs a half wave rectifier tube, V_4 . The output of this rectifier is filtered by a resistance-capacitor filter consisting of 0.5-0.5 μ fd. and .18 M. A voltage divider network attached from the output of this filter obtains the proper operating potentials for the various electrodes of the cathode-ray tube. The complete schematic of the Du Mont 274-A Oscilloscope is shown in figure 8.

9-2 Display of Waveforms

Together with a working knowledge of the controls of the oscilloscope, an understanding of how the patterns are traced on the screen must be obtained for a thorough knowledge of oscilloscope operation. With this in mind a careful analysis of two fundamental waveform patterns is discussed under the following headings:

- a. Patterns plotted against time (using the sweep generator for horizontal deflection).
- b. Lissajous Figures (using a sine wave for horizontal deflection).

Patterns Plotted Against Time A sine wave is typical of such a pattern and is convenient for this study. This

wave is amplified by the vertical amplifier and impressed on the vertical (Y-axis) deflection plates of the cathode-ray tube. Simultaneously the sawtooth wave from the time base generator is amplified and impressed on the horizontal (X-axis) deflection plates.

The electron beam moves in accordance with the resultant of the sine and sawtooth signals. The effect is shown in figure 9 where the sine and sawtooth waves are graphically represented on time and voltage axes. Points on the two waves that occur simultaneously are numbered similarly. For example, point 2 on the sine wave and point 2 on the sawtooth wave occur at the same instant. Therefore the position of the beam at instant 2 is the resultant of the voltages on the horizontal and vertical deflection plates at instant 2. Referring to figure 9, by projecting lines from the two point 2 positions, the position of the electron beam at instant 2 can be located. If projections were drawn from every other instantaneous position of each wave to intersect on the circle representing the tube screen, the intersections of similarly timed projections would trace out a sine wave.

In summation, figure 9 illustrates the principles involved in producing a sine wave trace on the screen of a cathode-ray tube. Each intersection of similarly timed projections represents the position of the electron beam acting under the influence of the varying voltage waveforms on each pair of deflection plates. Figure 10 shows the effect on the pattern of decreasing the frequency of the sawtooth

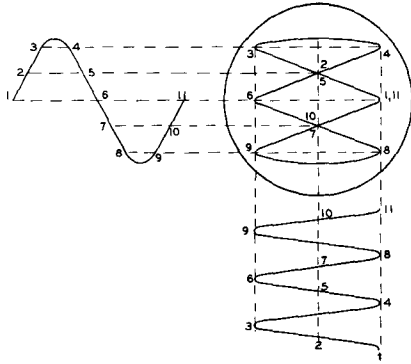

Figure 11

PROJECTION DRAWING SHOWING THE RESULTANT LISSAJOUS PATTERN WHEN A SINE WAVE APPLIED TO THE HORIZONTAL AXIS IS THREE TIMES THAT APPLIED TO THE VERTICAL AXIS

wave. Any recurrent waveform plotted against time can be displayed and analyzed by the same procedure as used in these examples.

The sine wave problem just illustrated is typical of the method by which any waveform can be displayed on the screen of the cathode-ray tube. Such waveforms as square wave, sawtooth wave, and many more irregular recurrent waveforms can be observed by the same method explained in the preceding paragraphs.

9-3 Lissajous Figures

Another fundamental pattern is the Lissajous figure, named after the 19th century French scientist. This type of pattern is of particular use in determining the frequency ratio between two sine wave signals. If one of these signals is known, the other can be easily calculated from the pattern made by the two signals upon the screen of the cathode-ray tube. Common practice is to connect the known signal to the horizontal channel and the unknown signal to the vertical channel.

The presentation of Lissajous figures can be analyzed by the same method as previously used for sine wave presentation. A simple example is shown in figure 11. The frequency ratio of the signal on the horizontal axis to the signal on the vertical axis is 3 to 1. If the known signal on the horizontal axis is 60 cycles per second, the signal on the vertical axis is 20 cycles.

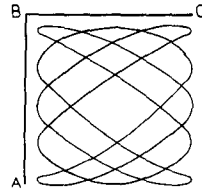

Figure 12

METHOD OF CALCULATING FREQUENCY RATIO OF LISSAJOUS FIGURES

Obtaining a Lissajous Pattern on the screen 1. The horizontal amplifier should be disconnected from the sweep oscillator. The signal to be examined should be connected to the horizontal amplifier of the oscilloscope.

Oscilloscope Settings 2. An audio oscillator signal should be connected to the vertical amplifier of the oscilloscope.

3. By adjusting the frequency of the audio oscillator a stationary pattern should be obtained on the screen of the oscilloscope. It is not necessary to stop the pattern, but merely to slow it up enough to count the loops at the side of the pattern.

4. Count the number of loops which intersect an imaginary vertical line AB and the number of loops which intersect the imaginary horizontal line BC as in figure 12. The ratio of the number of loops which intersect AB is to

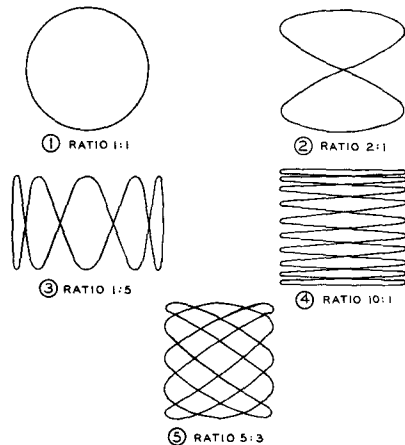

Figure 13

OTHER LISSAJOUS PATTERNS

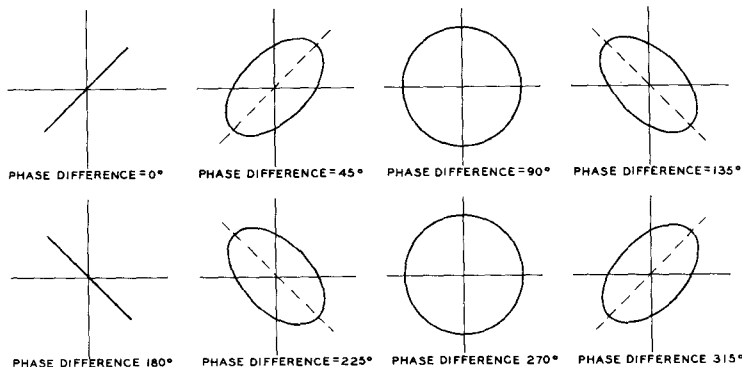

Figure 14

LISSAJOUS PATTERNS OBTAINED FROM THE MAJOR PHASE DIFFERENCE ANGLES

the number of loops which intersect BC as the frequency of the horizontal signal is to the frequency of the vertical signal.

Figure 13 shows other examples of Lissajous figures. In each case the frequency ratio shown is the frequency ratio of the signal on the horizontal axis to that on the vertical axis.

Phase Difference Patterns Coming under the heading of Lissajous figures is the method used to determine the phase difference between signals of the same frequency. The patterns involved take on the form of ellipses with different degrees of eccentricity.

The following steps should be taken to obtain a phase-difference pattern:

1. With no signal input to the oscilloscope, the spot should be centered on the screen of the tube.
2. Connect one signal to the vertical amplifier of the oscilloscope, and the other signal to the horizontal amplifier.
3. Connect a common ground between the two frequencies under investigation and the oscilloscope.
4. Adjust the vertical amplifier gain so as to give about 3 inches of deflection on a 5 inch tube, and adjust the calibrated scale of the oscilloscope so that the vertical axis of the scale coincides precisely with the vertical deflection of the spot.
5. Remove the signal from the vertical amplifier, being careful not to change the setting of the vertical gain control.
6. Increase the gain of the horizontal amplifier to give a deflection exactly the same as that to which the vertical am-

plifier control is adjusted (3 inches). Reconnect the signal to the vertical amplifier.

The resulting pattern will give an accurate picture of the exact phase difference between the two waves. If these two patterns are exactly the same frequency but different in phase and maintain that difference, the pattern on the screen will remain stationary. If, however, one of these frequencies is drifting slightly, the pattern will drift slowly through 360°. The phase angles of 0°, 45°, 90°, 135°, 180°, 225°, 270°, 315° are shown in figure 14.

Each of the eight patterns in figure 14 can be analyzed separately by the previously used

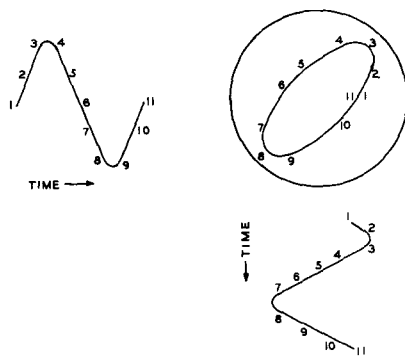

Figure 15

PROJECTION DRAWING SHOWING THE RESULTANT PHASE DIFFERENCE PATTERN OF TWO SINE WAVES 45° OUT OF PHASE

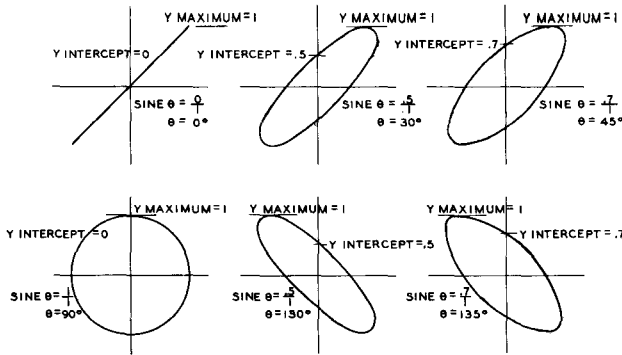

Figure 16

EXAMPLES SHOWING THE USE OF THE FORMULA FOR DETERMINATION OF PHASE DIFFERENCE

projection method. Figure 15 shows two sine waves which differ in phase being projected on to the screen of the cathode-ray tube. These signals represent a phase difference of 45°. It is extremely important: (1) that the spot has been centered on the screen of the cathode-ray tube, (2) that both the horizontal and vertical amplifiers have been adjusted to give exactly the same gain, and (3) that the calibrated scale be originally set to coincide with the displacement of the signal along the vertical axis. If the amplifiers of the oscilloscope are not used for conveying the signal to the deflection plates of the cathode-ray tube, the coarse frequency switch should be set to *horizontal input direct* and the vertical input

switch to *direct* and the outputs of the two signals must be adjusted to result in exactly the same vertical deflection as horizontal deflection. Once this deflection has been set by either the oscillator output controls or the amplifier gain controls in the oscillograph, it should not be changed for the duration of the measurement.

Determination of the Phase Angle

The relation commonly used in determining the phase angle between signals is:

$$\text{Sine } \theta = \frac{\text{Y intercept}}{\text{Y maximum}}$$

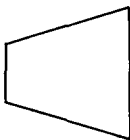

Figure 17

TRAPEZOIDAL MODULATION PATTERN

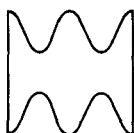

Figure 18

MODULATED CARRIER WAVE PATTERN

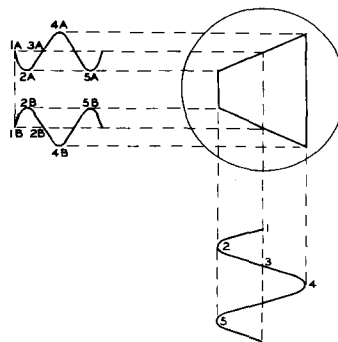

Figure 19

PROJECTION DRAWING SHOWING TRAPEZOIDAL PATTERN

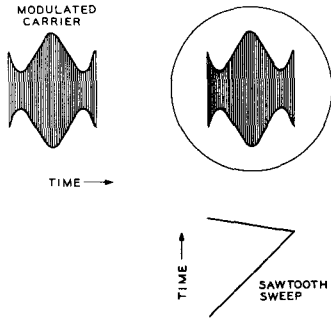

Figure 20
PROJECTION DRAWING SHOWING MODULATED CARRIER WAVE PATTERN

where θ = phase angle between signals
 Y intercept = point where ellipse crosses vertical axis measured in tenths of inches. (Calibrations on the calibrated screen)
 Y maximum = highest vertical point on ellipse in tenths of inches

Several examples of the use of the formula are given in figure 16. In each case the Y intercept and Y maximum are indicated together with the sine of the angle and the angle itself. For the operator to observe these various patterns with a single signal source such as the test signal, there are many types of phase shifters which can be used. Circuits can be obtained from a number of radio text books. The procedure is to connect the original signal to the horizontal channel of the oscilloscope and the signal which has passed through the phase shifter to the vertical channel of the oscilloscope, and follow the procedure set forth in this discussion to observe the various phase shift patterns.

9.4 Monitoring Transmitter Performance with the Oscilloscope

The oscilloscope may be used as an aid for the proper operation of a radiotelephone transmitter, and may be used as an indicator of the overall performance of the transmitter output signal, and as a modulation monitor.

Waveforms There are two types of patterns that can serve as indicators, the trapezoidal pattern (figure 17) and the modu-

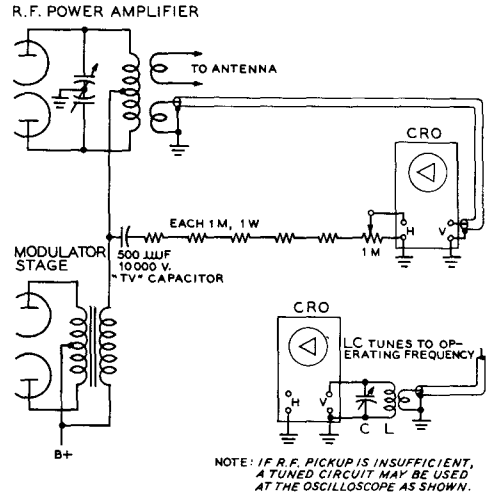

Figure 21
MONITORING CIRCUIT FOR TRAPEZOIDAL MODULATION PATTERN

lated wave pattern (figure 18). The trapezoidal pattern is presented on the screen by impressing a modulated carrier wave signal on the vertical deflection plates and the signal that modulates the carrier wave signal (the modulating signal) on the horizontal deflection plates. The trapezoidal pattern can be analyzed by the method used previously in analyzing waveforms. Figure 19 shows how the signals cause the electron beam to trace out the pattern.

The modulated wave pattern is accomplished by presenting a modulated carrier wave on the vertical deflection plates and by using the time-base generator for horizontal deflection. The modulated wave pattern also can be used for analyzing waveforms. Figure 20 shows how the two signals cause the electron beam to trace out the pattern.

The Trapezoidal Pattern The oscilloscope connections for obtaining a trapezoidal pattern are shown in figure 21. A portion of the audio output of the transmitter modulator is applied to the horizontal input of the oscilloscope. The vertical amplifier of the oscilloscope is disconnected, and a small amount of modulated r-f energy is coupled directly to the vertical deflection plates of the oscilloscope. A small pickup loop, loosely coupled to the final amplifier tank circuit and connected to the vertical de-

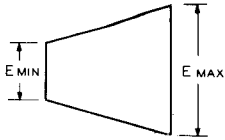

Figure 22

(LESS THAN 100% MODULATION)

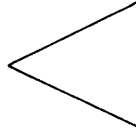

Figure 23

(100% MODULATION)

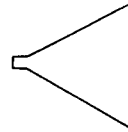

Figure 24

(OVER MODULATION)

TRAPEZOIDAL WAVE PATTERN

flection plates by a short length of coaxial line will suffice. The amount of excitation to the plates of the oscilloscope may be adjusted to provide a pattern of convenient size. Upon modulation of the transmitter, the trapezoidal pattern will appear. By changing the degree of modulation of the carrier wave the shape of the pattern will change. Figures 22 and 23 show the trapezoidal pattern for various degrees of modulation. The percentage of modulation may be determined by the following formula:

$$\text{Modulation percentage} = \frac{E_{\max} - E_{\min}}{E_{\max} + E_{\min}} \times 100$$

where E_{\max} and E_{\min} are defined as in figure 22.

An overmodulated signal is shown in figure 24.

The Modulated Wave Pattern The oscilloscope connections for obtaining a modulated wave pattern are shown in

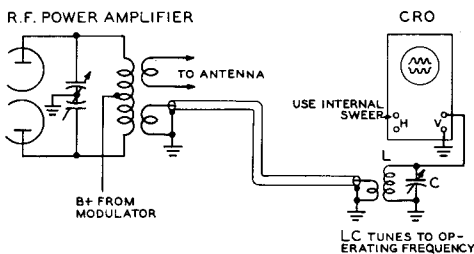

Figure 25

MONITORING CIRCUIT FOR MODULATED WAVE PATTERN

figure 25. The internal sweep circuit of the oscilloscope is applied to the horizontal plates, and the modulated r-f signal is applied to the vertical plates, as described before. If desired, the internal sweep circuit may be synchronized with the modulating signal of the transmitter by applying a small portion of the modulator output signal to the external sync post of the oscilloscope. The percentage of modulation may be determined in the same fashion as with a trapezoidal pattern. Figures 26, 27 and 28 show the modulated wave pattern for various degrees of modulation.

9-5 Receiver I-F Alignment with an Oscilloscope

The alignment of the i-f amplifiers of a receiver consists of adjusting all the tuned circuits to resonance at the intermediate frequency and at the same time to permit passage of a predetermined number of side bands. The best indication of this adjustment is a resonance curve representing the response of the i-f circuit to its particular range of frequencies.

As a rule medium and low-priced receivers use i-f transformers whose bandwidth is about 5 kc. on each side of the fundamental frequency. The response curve of these i-f transformers is shown in figure 29. High fidelity receivers usually contain i-f transformers which have a broader bandwidth which is usually 10 kc. on each side of the fundamental. The response curve for this type transformer is shown in figure 30.

Resonance curves such as these can be displayed on the screen of an oscilloscope. For a complete understanding of the procedure it is important to know how the resonance curve is traced.

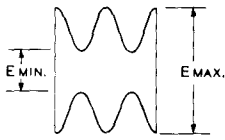

Figure 26

(LESS THAN 100% MODULATION)



Figure 27

(100% MODULATION)

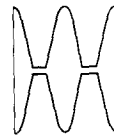

Figure 28

(OVER MODULATION)

CARRIER WAVE PATTERN

The Resonance Curve on the Screen To present a resonance curve on the screen, a frequency-modulated signal source must be available. This signal source is a signal generator whose output is the fundamental i-f frequency which is frequency-modulated 5 to 10 kc. each side of the fundamental frequency. A signal generator of this type generally takes the form of an ordinary signal generator with a rotating motor driven tuned circuit capacitor, called a *wob-*

ulator, or its electronic equivalent, a reactance tube.

The method of presenting a resonance curve on the screen is to connect the vertical channel of the oscilloscope across the detector load of the receiver as shown in the detectors of figure 31 (between point A and ground) and the time-base generator output to the horizontal channel. In this way the d-c voltage across the detector load varies with the frequencies which are passed by the i-f system. Thus, if the time-base generator is set at the frequency of rotation of the motor driven capacitor, or the reactance tube, a pattern resembling figure 32, a double resonance curve, appears on the screen.

Figure 32 is explained by considering figure 33. In half a rotation of the motor driven capacitor the frequency increases from 445 kc. to 465 kc., more than covering the range of frequencies passed by the i-f system. Therefore, a full resonance curve is presented on the screen during this half cycle of rotation since only *half* a cycle of the voltage producing horizontal deflection has transpired. In the second half of the rotation the motor

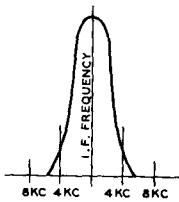

Figure 29

FREQUENCY RESPONSE CURVE OF THE I-F OF A LOW PRICED RECEIVER

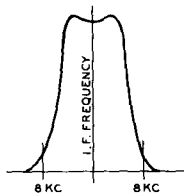
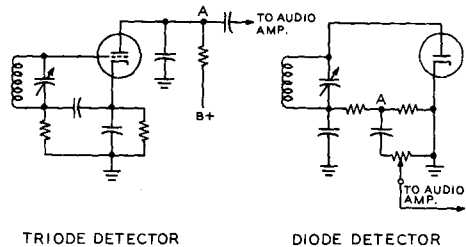

Figure 30

FREQUENCY RESPONSE OF HIGH-FIDELITY I-F SYSTEM



TRIODE DETECTOR

DIODE DETECTOR

Figure 31

CONNECTION OF THE OSCILLOSCOPE ACROSS THE DETECTOR LOAD

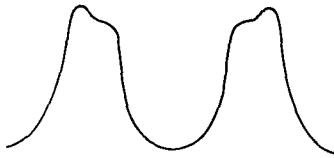

Figure 32
DOUBLE RESONANCE CURVE

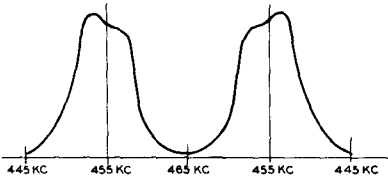

Figure 33
DOUBLE RESONANCE ACHIEVED BY COMPLETE ROTATION OF THE MOTOR DRIVEN CAPACITOR



Figure 34
SUPER-POSITION OF RESONANCE CURVES

driven capacitor takes the frequency of the signal in the reverse order through the range of frequencies passed by the i-f system. In this interval the time-base generator sawtooth waveform completes its cycle, drawing the electron beam further across the screen and then returning it to the starting point. Subsequent cycles of the motor driven capacitor and the sawtooth voltage merely retrace the same pattern. Since the signal being viewed is applied through the vertical amplifier, the sweep can be synchronized internally.

Some signal generators, particularly those employing a reactance tube, provide a sweep output in the form of a sine wave which is synchronized to the frequency with which the reactance tube is swinging the fundamental frequency through its limits, usually 60 cycles per second. If such a signal is used for horizontal deflection, it is already synchronized. Since this signal is a sine wave, the response

curve is observed as it sweeps the spot across the screen from left to right; and it is observed again as the sine wave sweeps the spot back again from right to left. Under these conditions the two response curves are superimposed on each other and the high frequency responses of both curves are at one end and the low frequency response of both curves is at the other end. The i-f trimmer capacitors are adjusted to produce a response curve which is symmetrical on each side of the fundamental frequency.

When using sawtooth sweep, the two response curves can also be superimposed. If the sawtooth signal is generated at exactly twice the frequency of rotation of the motor driven capacitor, the two resonance curves will be superimposed (figure 34) if the i-f transformers are properly tuned. If the two curves do not coincide the i-f trimmer capacitors should be adjusted. At the point of coincidence the tuning is correct. It should be pointed out that rarely do the two curves agree perfectly. As a result, optimum adjustment is made by making the peaks coincide. This latter procedure is the one generally used in i-f adjustment. When the two curves coincide, it is evident that the i-f system responds equally to signals higher and lower than the fundamental i-f frequency.

9-6 Single Sideband Applications

Measurement of power output and distortion are of particular importance in SSB transmitter adjustment. These measurements are related to the extent that distortion rises rapidly when the power amplifier is overloaded. The useable power output of a SSB transmitter is often defined as the maximum peak envelope power

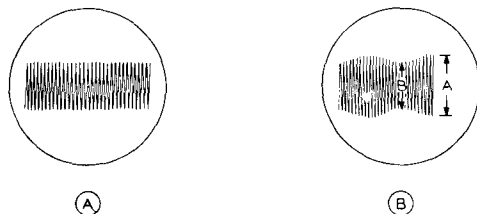

Figure 35
SINGLE TONE PRESENTATION

Oscilloscope trace of SSB signal modulated by single tone (A). Incomplete carrier suppression or spurious products will show modulated envelope of (B). The ratio of suppression is:

$$S = 20 \log \frac{A+B}{A-B}$$

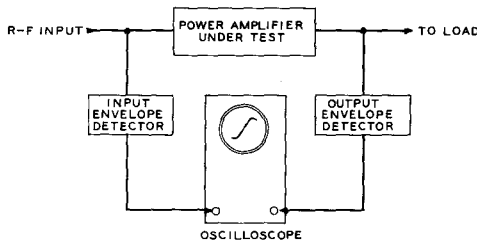

Figure 36
BLOCK DIAGRAM OF
LINEARITY TRACER

obtainable with a specified *signal-to-distortion* ratio. The oscilloscope is a useful instrument for measuring and studying distortion of all types that may be generated in single sideband equipment.

Single Tone Observations When a SSB transmitter is modulated with a single audio tone, the r-f output should be a single radio frequency. If the vertical plates of the oscilloscope are coupled to the output of the transmitter, and the horizontal amplifier sweep is set to a slow rate, the scope presentation will be as shown in figure 35. If unwanted distortion products or carrier are present, the top and bottom of the pattern will develop a "ripple" proportional to the degree of spurious products.

The Linearity Tracer The linearity tracer is an auxiliary detector to be used with an oscilloscope for quick observation of amplifier adjustments and parameter variations. This instrument consists of two SSB envelope detectors the outputs of which connect to the horizontal and vertical inputs of an oscilloscope. Figure 36 shows a block diagram of a typical linearity test set-up. A two-tone test signal is normally employed to supply a SSB modulation envelope, but any modulating signal that provides an envelope that varies from zero to full amplitude may be used. Speech modulation gives a satisfactory trace, so that this instrument may be used as a visual monitor of transmitter linearity. It is particularly useful for monitoring the signal level and clearly shows when the amplifier under observation is overloaded. The linearity trace will be a straight line regardless of the envelope shape if the amplifier has no distortion. Overloading causes a sharp break in the linearity curve. Distortion due to too much bias is also easily observed and the adjustment for low distortion can easily be made.

Another feature of the linearity detector is

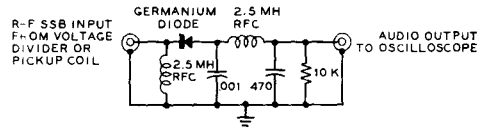

Figure 37
SCHEMATIC OF
ENVELOPE DETECTOR

that the distortion of each individual stage can be observed. This is helpful in troubleshooting. By connecting the input envelope detector to the output of the SSB generator, the overall distortion of the entire r-f circuit beyond this point is observed. The unit can also serve as a voltage indicator which is useful in making tuning adjustments.

The circuit of a typical envelope detector is shown in figure 37. Two matched germanium diodes are used as detectors. The detectors are not linear at low signal levels, but if the nonlinearity of the two detectors is matched, the effect of their nonlinearity on the oscilloscope trace is cancelled. The effect of diode differences is minimized by using a diode load of 5,000 to 10,000 ohms, as shown. It is important that both detectors operate at approximately the same signal level so that their differences will cancel more exactly. The operating level should be 1-volt or higher.

It is convenient to build the detector in a small shielded enclosure such as an i-f transformer can fitted with coaxial input and output connectors. Voltage dividers can be similarly constructed so that it is easy to insert the desired amount of voltage attenuation from the various sources. In some cases it is convenient to use a pickup loop on the end of a short length of coaxial cable.

The phase shift of the amplifiers in the oscilloscope should be the same and their frequency response should be flat out to at least twenty times the frequency difference of the two test tones. Excellent high frequency characteristics are necessary because the rectified SSB envelope contains harmonics extending to the limit of the envelope detector's response. Inadequate frequency response of the vertical amplifier may cause a little "foot" to appear on the lower end of the trace, as shown in figure 38. If it is small, it may be safely neglected.

Another spurious effect often encountered is a double trace, as shown in figure 39. This can usually be corrected with an R-C network placed between one detector and the oscilloscope. The best method of testing the detectors and the amplifiers is to connect the input of

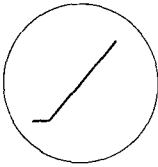

Figure 38
EFFECT OF INADEQUATE
RESPONSE OF VERTICAL
AMPLIFIER

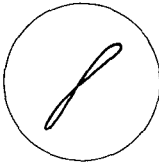

Figure 39
DOUBLE TRACE
CAUSED BY PHASE
SHIFT

the envelope detectors in parallel. A perfectly straight line trace will result when everything is working properly. One detector is then connected to the other r-f source through a voltage divider adjusted so that no appreciable change in the setting of the oscilloscope amplifier controls is required. Figure 40 illustrates some typical linearity traces. *Trace A* is caused by inadequate static plate current in class A or class B amplifiers or a mixer stage. To regain linearity, the grid bias of the stage should be reduced, the screen voltage should be raised, or the signal level should be decreased. *Trace B* is a result of poor grid circuit regulation when grid current is drawn, or a result of non-

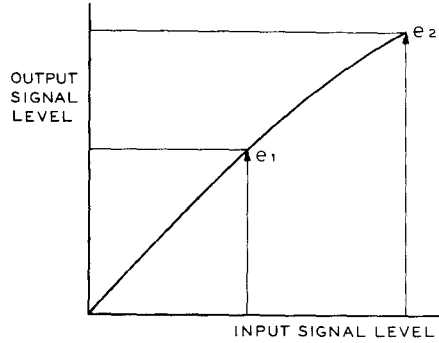
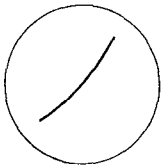

Figure 41
ORDINATES ON LINEARITY
CURVE FOR 3RD ORDER
DISTORTION EQUATION

linear plate characteristics of the amplifier tube at large plate swings. More grid swamping should be used, or the exciting signal should be reduced. A combination of the effects of A and B are shown in *Trace C*. *Trace D* illustrates amplifier overloading. The exciting signal should be reduced.

A means of estimating the distortion level observed is quite useful. The first and third order distortion components may be derived by an equation that will give the approximate signal-to-distortion level ratio of a two tone test signal, operating on a given linearity curve. Figure 41 shows a linearity curve with two ordinates erected at half and full peak input signal level. The length of the ordinates e_1 and e_2 may be scaled and used in the following equation:

$$\text{Signal-to-distortion ratio in db} = 20 \log \frac{8 e_1 - e_2}{2 e_1 - e_2}$$



(A)

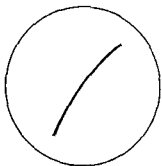

(B)

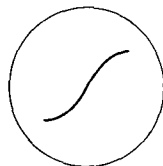

(C)

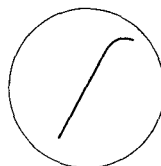

(D)

TYPICAL LINEARITY TRACES

Figure 40
TYPICAL LINEARITY
TRACES

Special Vacuum Tube Circuits

A whole new concept of vacuum tube applications has been developed in recent years. No longer are vacuum tubes chained to the field of communication. This chapter is devoted to some of the more common circuits encountered in industrial and military applications of the vacuum tube.

10-1 Limiting Circuits

The term *limiting* refers to the removal or suppression by electronic means of the extremities of an electronic signal. Circuits which perform this function are referred to as *limiters* or *clippers*. Limiters are useful in wave-shaping circuits where it is desirable to square off the extremities of the applied signal. A sine wave may be applied to a limiter circuit to produce a rectangular wave. A peaked wave may be applied to a limiter circuit to eliminate either the positive or negative peaks from the output. Limiter circuits are employed in FM receivers where it is necessary to limit the amplitude of the signal applied to the detector. Limiters may be used to reduce automobile ignition noise in short-wave receivers, or to maintain a high average level of modulation in a transmitter. They may also be used as protective devices to limit input signals to special circuits.

Diode Limiters The characteristics of a diode tube are such that the tube conducts only when the plate is at a positive potential with respect to the cathode. A positive potential may be placed on the cathode, but the tube will not conduct until the voltage on the plate rises above an equally positive value. As the plate becomes more positive with respect to the cathode, the diode conducts and passes that portion of the wave that is more positive than the cathode voltage. Diodes may be used as either series or parallel limiters, as shown in figure 1. A diode may be so biased that only a certain portion of the positive or negative cycle is removed.

Audio Peak Limiting An audio peak clipper consisting of two diode limiters may be used to limit the amplitude of an audio signal to a predetermined value to provide a high average level of modulation without danger of overmodulation. An effective limiter for this service is the *series-diode gate clipper*. A circuit of this clipper is shown in figure 2. The audio signal to be clipped is coupled to the clipper through C_1 . R_1 and R_2 are the clipper input and output load resistors. The clipper plates are tied together and are connected to the clipping level control, R_4 , through the series resistor, R_3 . R_4 acts as a voltage divider between the high voltage supply and ground. The exact point at which clip-

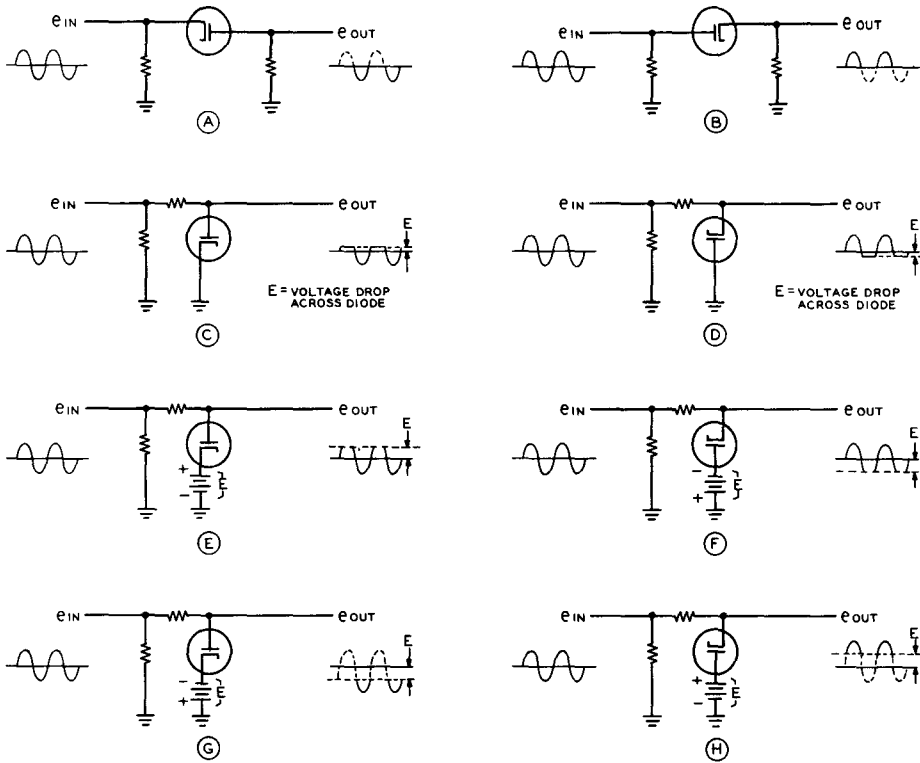

Figure 1
VARIOUS DIODE LIMITING CIRCUITS

Series diodes limiting positive and negative peaks are shown in A and B. Parallel diodes limiting positive and negative peaks are shown in C and D. Parallel diodes limiting above and below ground are shown in E and F. Parallel diode limiters which pass negative and positive peaks are shown in G and H.

ping will occur is set by R_4 , which controls the positive potential applied to the diode plates.

Under static conditions, a d-c voltage is obtained from R_4 and applied through R_3 to both plates of the 6AL5 tube. Current flows through R_4 , R_3 , and divides through the two diode sections of the 6AL5 and the two load resistors, R_1 and R_2 . All parts of the clipper circuit are maintained at a positive potential above ground. The voltage drop between the plate and cathode of each diode is very small compared to the drop across the 300,000-ohm resistor (R_3) in series with the diode plates. The plate and cathode of each diode are therefore maintained at approximately equal potentials as long as there is plate current flow. Clipping does not occur until the peak audio input voltage reaches a value greater than the static voltages at the plates of the diode.

Assume that R_4 has been set to a point that will give 4 volts at the plates of the 6AL5. When the peak audio input voltage is less than 4 volts, both halves of the tube conduct at all times. As long as the tube conducts, its resistance is very low compared with the plate resistor R_3 . Whenever a voltage change occurs across input resistor R_1 , the voltage at all of the tube elements increases or decreases by the same amount as the input voltage change, and the voltage drop across R_3 changes by an equal amount. As long as the peak input voltage is less than 4 volts, the 6AL5 acts merely as a conductor, and the output cathode is permitted to follow all voltage changes at the input cathode.

If, under static conditions, 4 volts appear at the diode plates, then twice this voltage (8 volts) will appear if one of the diode circuits

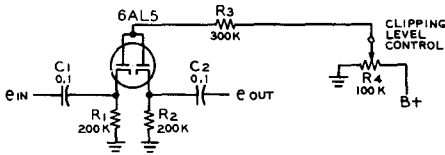

Figure 2
THE SERIES-DIODE GATE CLIPPER FOR
AUDIO PEAK LIMITING

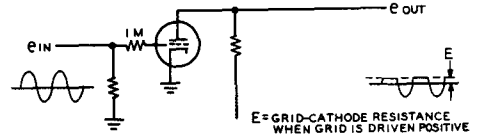

Figure 3
GRID LIMITING CIRCUIT

is opened, removing its d-c load from the circuit. As long as only one of the diodes continues to conduct, the voltage at the diode plates cannot rise above twice the voltage selected by R_4 . In this example, the voltage cannot rise above 8 volts. Now, if the input audio voltage applied through C_1 is increased to any peak value between zero and plus 4 volts, the first cathode of the 6AL5 will increase in voltage by the same amount to the proper value between 4 and 8 volts. The other tube elements will assume the same potential as the first cathode. However, the 6AL5 plates cannot increase more than 4 volts above their original 4-volt static level. When the input voltage to the first cathode of the 6AL5 increases to more than plus 4 volts, the cathode potential increases to more than 8 volts. Since the plate circuit potential remains at 8 volts, the first diode section ceases to conduct until the input voltage across R_1 drops below 4 volts.

When the input voltage swings in a negative direction, it will subtract from the 4-volt drop across R_1 and decrease the voltage on the input cathode by an amount equal to the input voltage. The plates and the output cathode will follow the voltage level at the input cathode as long as the input does not swing below minus 4 volts. If the input voltage does not change more than 4 volts in a negative direction, the plates of the 6AL5 will also become negative. The potential at the output cathode will follow the input cathode voltage and decrease from its normal value of 4 volts until it reaches zero potential. As the input cathode voltage decreases to less than zero,

the plates will follow. However, the output cathode, grounded through R_2 , will stop at zero potential as the plate becomes negative. Conduction through the second diode is impossible under these conditions. The output cathode remains at zero potential until the voltage at the input cathode swings back to zero.

The voltage developed across output resistor R_2 follows the input voltage variations as long as the input voltage does not swing to a peak value greater than the static voltage at the diode plates, determined by R_4 . Effective clipping may thus be obtained at any desired level.

The square-topped audio waves generated by this clipper are high in harmonic content, but these higher order harmonics may be greatly reduced by a low-level speech filter.

Grid Limiters A triode grid limiter is shown in figure 3. On positive peaks of the input signal, the triode grid attempts to swing positive, and the grid-cathode resistance drops to a value on the order of 1000 ohms or so. The voltage drop across R (usually of the order of 1 megohm) is large compared to the grid-cathode drop, and the resulting limiting action removes the top part of the positive input wave.

10-2 Clamping Circuits

A circuit which holds either amplitude extreme of a waveform to a given reference level

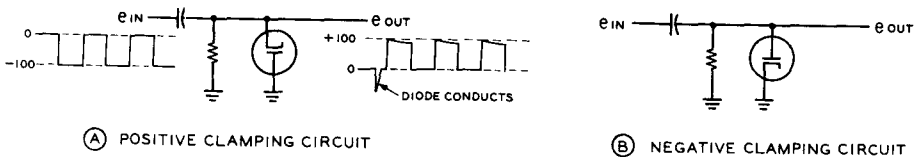

Figure 4
SIMPLE POSITIVE AND NEGATIVE CLAMPING CIRCUITS

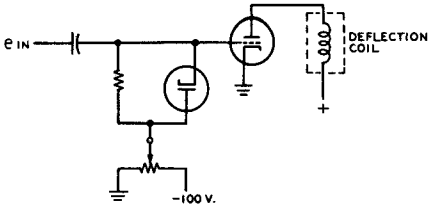

Figure 5
NEGATIVE CLAMPING CIRCUIT EMPLOYED IN ELECTROMAGNETIC SWEEP SYSTEM

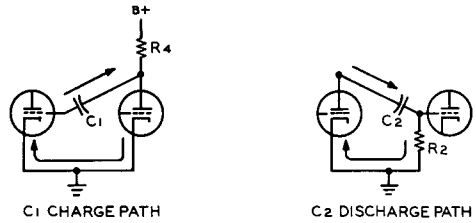

Figure 7
THE CHARGE AND DISCHARGE PATHS IN FREE-RUNNING MULTIVIBRATOR OF FIGURE 6

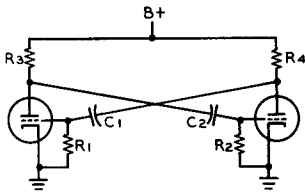

Figure 6
BASIC MULTIVIBRATOR CIRCUIT

is repeated and therefore is "jittery." If a clamping circuit is placed between the sweep amplifier and the deflection element, the start of the sweep can be regulated by adjusting the d-c voltage applied to the clamping tube (figure 5).

10-3 Multivibrators

The multivibrator, or relaxation oscillator, is used for the generation of nonsinusoidal waveforms. The output is rich in harmonics, but the inherent frequency stability is poor. The multivibrator may be stabilized by the introduction of synchronizing voltages of harmonic or subharmonic frequency.

In its simplest form, the multivibrator is a simple two-stage resistance-capacitance coupled amplifier with the output of the second stage coupled through a capacitor to the grid of the first tube, as shown in figure 6. Since the output of the second stage is of the proper polarity to reinforce the input signal applied to the first tube, oscillations can readily take place, started by thermal agitation noise and

of potential is called a *clamping circuit* or a *d-c restorer*. Clamping circuits are used after RC coupling circuits where the waveform swing is required to be either above or below the reference voltage, instead of alternating on both sides of it (figure 4). Clamping circuits are usually encountered in oscilloscope sweep circuits. If the sweep voltage does not always start from the same reference point, the trace on the screen does not begin at the same point on the screen each time the sweep

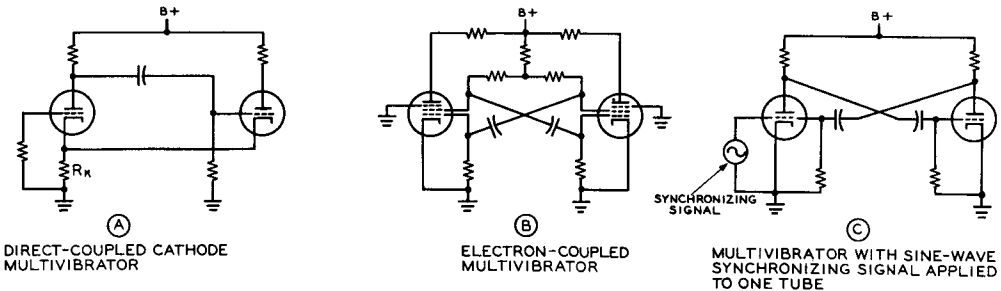

Figure 8
VARIOUS FORMS OF MULTIVIBRATOR CIRCUITS

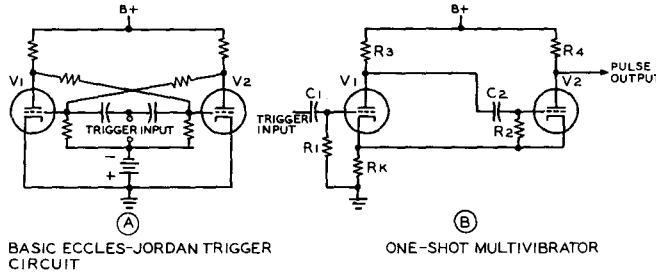

Figure 9

ECCLES-JORDAN MULTIVIBRATOR CIRCUITS

miscellaneous tube noise. Oscillation is maintained by the process of building up and discharging the store of energy in the grid coupling capacitors of the two tubes. The charging and discharging paths are shown in figure 7. Various forms of multivibrators are shown in figure 8.

The output of a multivibrator may be used as a source of square waves, as an electronic switch, or as a means of obtaining frequency division. Submultiple frequencies as low as one-tenth of the injected synchronizing frequency may easily be obtained.

The Eccles-Jordan Circuit

The Eccles-Jordan trigger circuit is shown in figure 9A. This is not a true multivibrator, but rather a circuit that possesses two conditions of stable equilibrium. One condition is when V_1 is conducting and V_2 is cutoff; the other when V_2 is conducting and V_1 is cutoff. The circuit remains in one or the other of these two stable conditions with no change in operating potentials until some external action occurs which causes the nonconducting tube to conduct. The tubes then reverse their functions and remain in the new condition as long as no plate current flows in the cutoff tube. This type of circuit is known as a *flip-flop* circuit.

The Eccles-Jordan trigger circuit is shown in figure 9A. This is not a true multivibrator, but rather a circuit that possesses two conditions of stable equilibrium. One condition is when V_1 is conducting and V_2 is cutoff; the other when V_2 is conducting and V_1 is cutoff. The circuit remains in one or the other of these two stable conditions with no change in operating potentials until some external action occurs which causes the nonconducting tube to conduct. The tubes then reverse their functions and remain in the new condition as long as no plate current flows in the cutoff tube. This type of circuit is known as a *flip-flop* circuit.

Figure 9B illustrates a modified Eccles-Jordan circuit which accomplishes a complete cycle when triggered with a positive pulse. Such a circuit is called a *one-shot* multivibrator. For initial action, V_1 is cutoff and V_2 is conducting. A large positive pulse applied to the grid of V_1 causes this tube to conduct, and the voltage at its plate decreases by virtue of the IR drop through R_3 . Capacitor C_2 is charged rapidly by this abrupt change in V_1 plate voltage, and V_2 becomes cutoff while V_1 conducts. This condition exists until C_2 discharges, allowing V_2 to conduct, raising the cathode bias of V_1 until it is once again cutoff.

A direct, cathode-coupled multivibrator is shown in figure 8A. R_K is a common cathode resistor for the two tubes, and coupling takes place across this resistor. It is impossible for a tube in this circuit to completely cutoff the other tube, and a circuit of this type is called a *free-running* multivibrator in which the condition of one tube temporarily cuts off the other.

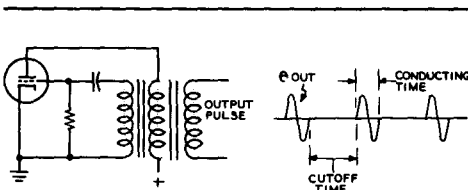

Figure 10

SINGLE-SWING BLOCKING OSCILLATOR

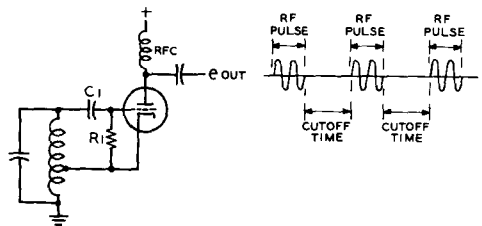

Figure 11

HARTLEY OSCILLATOR USED AS BLOCKING OSCILLATOR BY PROPER CHOICE OF R_1-C_1

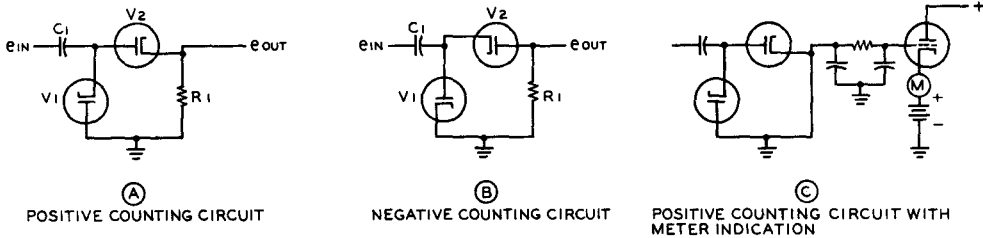

Figure 12
POSITIVE AND NEGATIVE COUNTING CIRCUITS

10-4 The Blocking Oscillator

A blocking oscillator is any oscillator which cuts itself off after one or more cycles caused by the accumulation of a negative charge on the grid capacitor. This negative charge may gradually be drained off through the grid resistor of the tube, allowing the circuit to oscillate once again. The process is repeated and the tube becomes an intermittent oscillator. The rate of such an occurrence is determined by the R-C time constant of the grid circuit. A *single-swing blocking oscillator* is shown in figure 10, wherein the tube is cutoff before the completion of one cycle. The tube produces single pulses of energy, the time between the pulses being regulated by the discharge time of the grid R-C network. The *self-pulsing blocking oscillator* is shown in figure 11, and is used to produce pulses of r-f energy, the number of pulses being determined by the timing network in the grid circuit of the oscillator. The rate at which these pulses occur is known as the *pulse-repetition frequency*, or *p.r.f.*

ing units to be counted, and produces a voltage that is proportional to the frequency of the pulses. A counting circuit may be used in conjunction with a blocking oscillator to produce a trigger pulse which is a submultiple of the frequency of the applied pulse. Either positive or negative pulses may be counted. A positive counting circuit is shown in figure 12A, and a negative counting circuit is shown in figure 12B. The positive counter allows a certain amount of current to flow through R_1 each time a pulse is applied to C_1 .

The positive pulse charges C_1 , and makes the plate of V_2 positive with respect to its cathode. V_2 conducts until the exciting pulse passes. C_1 is then discharged by V_1 , and the circuit is ready to accept another pulse. The average current flowing through R_1 increases as the pulse-repetition frequency increases, and decreases as the p.r.f. decreases.

By reversing the diode connections, as shown in figure 12B, the circuit is made to respond to negative pulses. In this circuit, an increase in the p.r.f. causes a decrease in the average current flowing through R_1 , which is opposite to the effect in the positive counter.

10-5 Counting Circuits

A *counting circuit*, or *frequency divider* is one which receives uniform pulses, represent-

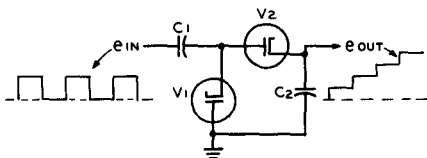

Figure 13
STEP-BY-STEP COUNTING CIRCUIT

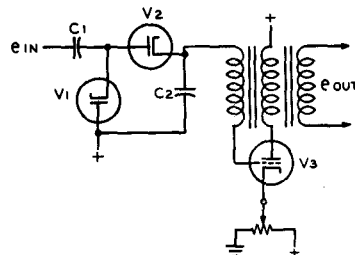
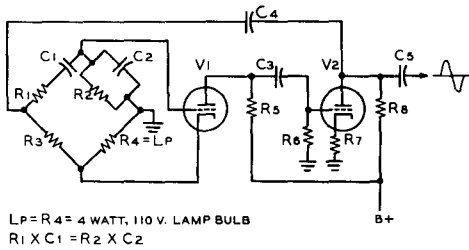

Figure 14
The step-by-step counter used to trigger a blocking oscillator. The blocking oscillator serves as a frequency divider.



LP = R4 = 4 WATT, 110 V. LAMP BULB
R1 X C1 = R2 X C2

Figure 15
THE WIEN-BRIDGE AUDIO OSCILLATOR

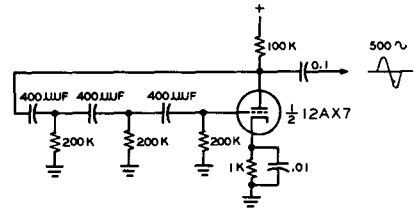

Figure 16
THE PHASE-SHIFT OSCILLATOR

A *step-counter* is similar to the circuits discussed, except that a capacitor which is large compared to C_1 replaces the diode load resistor. The charge of this condenser is increased during the time of each pulse, producing a step voltage across the output (figure 13). A blocking oscillator may be connected to a step-counter, as shown in figure 14. The oscillator is triggered into operation when the voltage across C_2 reaches a point sufficiently positive to raise the grid of V_3 above cutoff. Circuit parameters may be chosen so that a count division up to $1/20$ may be obtained with reliability.

circuit. The frequency at which oscillation occurs is:

$$f = \frac{1}{2\pi R_1 C_1}, \text{ when } R_1 \times C_1 = R_2 \times C_2$$

A lamp L_p is used as the cathode resistor of V_1 as a thermal stabilizer of the oscillator amplitude. The variation of the resistance with respect to current of the lamp bulb holds the oscillator output voltage at a nearly constant amplitude.

10-6 Resistance-Capacity Oscillators

In an R-C oscillator, the frequency is determined by a resistance capacity network that provides regenerative coupling between the output and input of a feedback amplifier. No use is made of a tank circuit consisting of inductance and capacitance to control the frequency of oscillation.

The *phase-shift* oscillator shown in figure 16 is a single tube oscillator using a three section phase shift network. Each section of the network produces a phase shift in proportion to the frequency of the signal that passes through it. For oscillations to be produced, the signal from the plate of the tube must be shifted 180° . Three successive phase shifts of 60° accomplish this, and the frequency of oscillation is determined by this phase shift. A high- μ triode or a pentode must be used in this circuit. In order to increase the frequency of oscillation, either the resistance or the capacitance must be decreased.

The *Wien-Bridge* oscillator employs a *Wien network* in the R-C feedback circuit and is shown in figure 15. Tube V_1 is the oscillator tube, and tube V_2 is an amplifier and phase-inverter tube. Since the feedback voltage through C_4 produced by V_2 is in phase with the input circuit of V_1 at all frequencies, oscillation is maintained by voltages of any frequency that exist in the circuit. The bridge circuit is used, then, to eliminate feedback voltages of all frequencies except the single frequency desired at the output of the oscillator. The bridge allows a voltage of only one frequency to be effective in the circuit because of the degeneration and phase shift provided by this

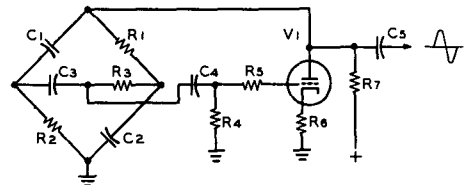

Figure 17
THE BRIDGE-TYPE PHASE-SHIFT OSCILLATOR

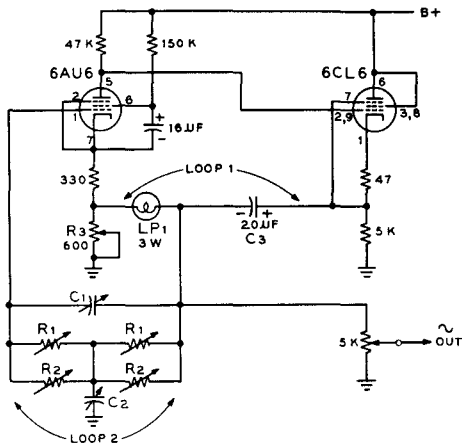

Figure 18
THE NBS BRIDGE-T
OSCILLATOR CIRCUIT AS USED
IN THE HEATH AG-9 AUDIO
GENERATOR

A bridge-type phase shift oscillator is shown in figure 17. The bridge is so proportioned that at only one frequency is the phase shift through the bridge 180°. Voltages of other frequencies are fed back to the grid of the tube out of phase with the existing grid signal, and are cancelled by being amplified out of phase.

The NBS Bridge-T oscillator developed by the National Bureau of Standards consists of a two stage amplifier having two feedback loops, as shown in figure 18. Loop 1 consists of a regenerative cathode-to-cathode loop, consisting of L_{p1} and C_3 . The bulb regulates the positive feedback, and tends to stabilize the output of the oscillator, much as in the manner of the Wien circuit. Loop 2 consists of a grid-cathode degenerative circuit, containing the bridge-T. Oscillation will occur at the null frequency of the bridge, at which frequency the bridge allows minimum degeneration in loop 2 (figure 19).

10-7 Feedback

Feedback amplifiers have been discussed in Chapter 6, section 15 of this Handbook. A more general use of feedback is in automatic control and regulating systems. Mechanical feedback has been used for many years in such forms as engine speed governors and steering servo engines on ships.

A simple feedback system for temperature control is shown in figure 20. This is a cause

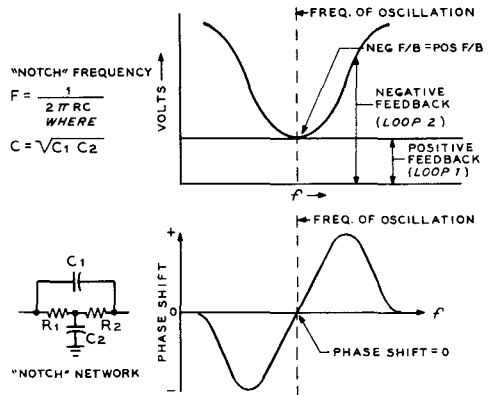

Figure 19
BRIDGE-T FEEDBACK
LOOP CIRCUITS

Oscillation will occur at the null frequency of the bridge, at which frequency the bridge allows minimum degeneration in loop 2.

and effect system. The furnace (F) raises the room temperature (T) to a predetermined value at which point the sensing thermostat (TH) reduces the fuel flow to the furnace. When the room temperature drops below the predetermined value the fuel flow is increased by the thermostat control. An interdependent control system is created by this arrangement: the room temperature depends upon the thermostat action, and the thermostat action depends upon the room temperature. This sequence of events may be termed a closed loop feedback system.

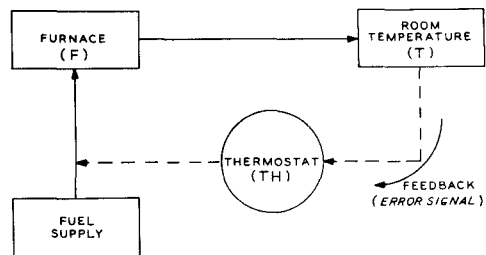

Figure 20
SIMPLE CLOSED LOOP
FEEDBACK SYSTEM

Room temperature (T) controls fuel supply to furnace (F) by feedback loop through Thermostat (TH) control.

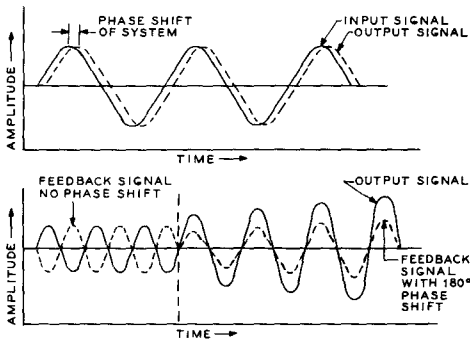

Figure 21
PHASE SHIFT OF ERROR
SIGNAL MAY CAUSE OSCILLA-
TION IN CLOSED LOOP SYSTEM

To prevent oscillation, the gain of the feedback loop must be less than unity when the phase shift of the system reaches 180 degrees.

Error Cancellation A feedback control system is dependent upon a degree of error in the output signal, since this error component is used to bring about the correction. This component is called the *error signal*. The error, or deviation from the desired signal

is passed through the feedback loop to cause an adjustment to reduce the value of the error signal. Care must be taken in the design of the feedback loop to reduce over-control tendencies wherein the correction signal would carry the system past the point of correct operation. Under certain circumstances the new error signal would cause the feedback control to overcorrect in the opposite direction, resulting in *bunting* or oscillation of the closed loop system about the correct operating point.

Negative feedback control would tend to damp out spurious system oscillation if it were not for the time lag or phase shift in the system. If the overall phase shift is equal to one-half cycle of the operating frequency of the system the feedback will maintain a steady state of oscillation when the circuit gain is sufficiently high, as shown in figure 21. In order to prevent oscillation, the gain figure of the feedback loop must be less than unity when the phase shift of the system reaches 180 degrees. In an ideal control system the gain of the loop would be constant throughout the operating range of the device, and would drop rapidly outside the range to reduce the bandwidth of the control system to a minimum.

The time lag in a closed loop system may be reduced by using electronic circuits in place of mechanical devices, or by the use of special circuit elements having a *phase-lead* characteristic. Such devices make use of the properties of a capacitor, wherein the current leads the voltage applied to it.

Electronic Computers

Mechanical computing machines were first produced in the seventeenth century in Europe although the simple Chinese *abacus* (a digital computer) had been in use for centuries. Until the last decade only simple mechanical computers (such as adding and book-keeping machines) were in general use.

The transformation and transmission of the volume of information required by modern

technology requires that machines assume many of the information processing systems formerly done by the human mind. Computing machines can perform routine operations more quickly and more accurately than a human being, processing mathematical and logistical data on a production line basis. The computer, however, cannot create, but can only follow instructions. If the instructions are in error,

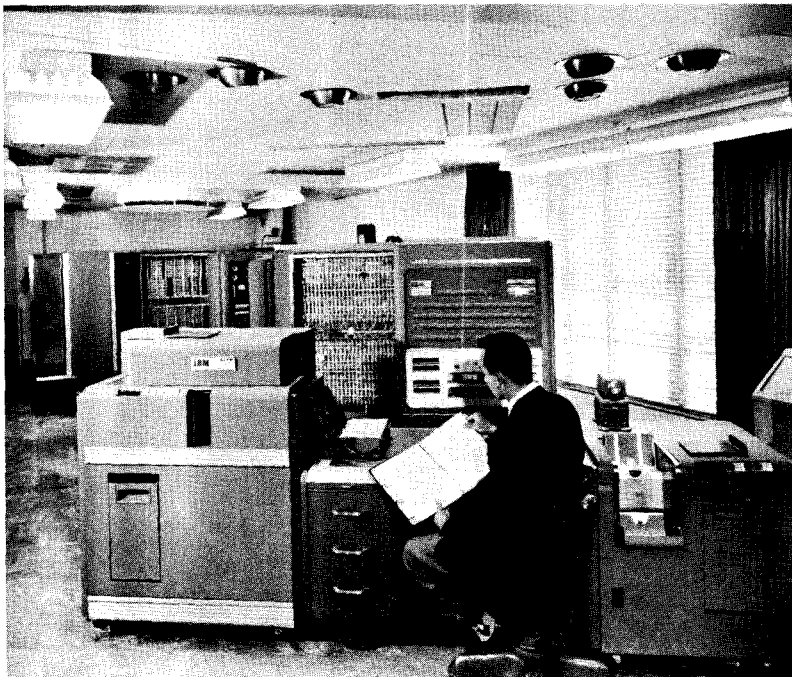

THE IBM COMPUTER AND "MEMORY"

The "704" Computer is used with 32,000 "word" memory storage unit for research programs. Heart of this auxiliary unit are small, doughnut-shaped iron ferrites which store information by means of magnetism. The unit is the first of its kind to be installed with IBM's 704 computer.

Components of the system seen in the foreground are (left) card punch and (right) card reader. In the center of the picture is the 704's processing unit.

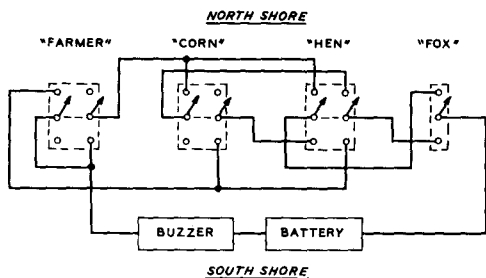

Figure 1
SIMPLE PUZZLES IN LOGIC MAY BE SOLVED BY ELECTRIC COMPUTER. THE "FARMER AND RIVER" COMPUTER IS SHOWN HERE.

the computer will produce a wrong answer.

Computers may be divided into two classes: the *digital* and the *analog*. The digital computer *counts*, and its accuracy is limited only by the number of significant figures provided for in the instrument. The analog computer *measures*, and its accuracy is limited by the percentage errors of the devices used, multiplied by the range of the variables they represent.

11-1 Digital Computers

The *digital computer* operates in discrete steps. In general, the mathematical operations are performed by combinations of additions. Thus multiplication is performed by repeated additions, and integration is performed by summation. The digital computer may be thought of as an "on-off" device operating from signals that either exist or do not exist. The common adding machine is a simple computer of this type. The "on-off" or "yes-no" type of situation is well suited to switches, electrical relays, or to electronic tubes.

A simple electrical digital computer may be used to solve the old "farmer and river" problem. The farmer must transport a hen, a bushel of corn, and a fox across a river in a small boat capable of carrying the farmer plus one other article. If the farmer takes the fox in the boat with him, the hen will eat the corn. On the other hand, if he takes the corn, the fox will eat the hen. The circuit for a simple computer to solve this problem is shown in figure 1. When the switches are moved from "south shore" to "north shore" in the proper sequence the warning buzzer will not sound. An error of choice will sound the buzzer.

A second simple "digital computer" is shown in figure 2. The problem is to find the three

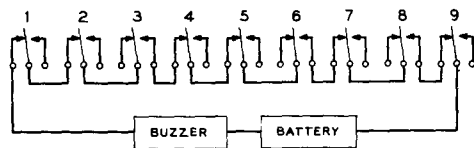

NOTE: ALL BUTTONS HAVE ONE NORMALLY OPEN CONTACT AND ONE NORMALLY CLOSED CONTACT.

Figure 2
A SEQUENCE COMPUTER.
Three correct buttons will sound the buzzer.

proper push buttons that will sound the buzzer. The nine buttons are mounted on a board so that the wiring cannot be seen.

Each switch of these simple computers executes an "on-off" action. When applied to a logical problem "yes-no" may be substituted for this term. The computer thus can act out a logical concept concerned with a simple choice. An electronic switch (tube) may be substituted for the mechanical switch to increase the speed of the computer. The early computers, such as the ENIAC (*Electronic Numerical Integrator and Calculator*) employed over 18,000 tubes for memory and registering circuits capable of "remembering" a 10-digit number.

11-2 Binary Notation

To simply and reduce the cost of the digital computer it was necessary to modify the system of operation so that fewer tubes were used per bit of information. The *ENIAC-type* computer requires 50 tubes to register a 5-digit number.

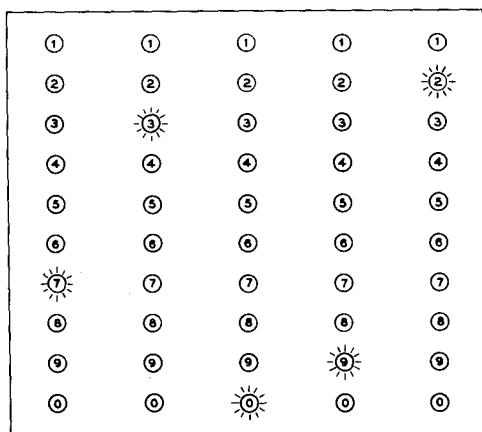

Figure 3
BINARY NOTATION MAY BE USED FOR DIGITAL DISPLAY. BINARY BOARD ABOVE INDICATES "73092."

①	②	④	⑧
DIGIT	TUBE(S)		
1	1		
2	2		
3	2+1		
4	4		
5	4+1		
6	4+2		
7	4+2+1		
8	8		
9	8+1		
10	8+2		
11	8+2+1		
12	8+4		
13	8+4+1		
14	8+4+2		
15	8+4+2+1		

Figure 4
BINARY DECIMAL NOTATION. ONLY FOUR TUBES ARE REQUIRED TO REPRESENT DIGITS FROM 1 TO 15. THE DIGIT "12" IS INDICATED ABOVE.

The tubes (or their indicator lamps) can be arranged in five columns of 10 tubes each. From right to left the columns represent units, tens, hundreds, thousands, etc. The bottom tube in each column represents "zero," the second tube represents "one," the third tube "two," and so on. Only one tube in each column is excited at any given instant. If the number 73092 is to be displayed, tube number seven in the fifth column is excited, tube number three in the fourth column, tube number zero in the third column, etc. as shown in figure 3.

A simpler system employs the *binary decimal* notation, wherein any number from one to fifteen can be represented by four tubes. Each of the four tubes has a numerical value that is associated with its position in the tube group. More than one tube of the group may be excited at once, as illustrated in figure 4. The values assigned to the tubes in this particular group are 1, 2, 4, and 8. Additional tubes may be added to the group, doubling the notation of the tube thus: 1, 2, 4, 8, 16, 32, 64, 128, 356, etc. Any numerical value lower than the highest group number can be displayed by the correct tube combination.

A third system employs the *binary notation* which makes use of a *bit* (binary digit) representing a single morsel of information. The binary system has been known for over forty centuries, and was considered a mystical revelation for ages since it employed only two sym-

DECIMAL NOTATION	BINARY NOTATION
0	0
1	1
2	1, 0
3	1, 1
4	1, 0, 0
5	1, 0, 1
6	1, 1, 0
7	1, 1, 1
8	1, 0, 0, 0
9	1, 0, 0, 1
10	1, 0, 1, 0

Figure 5
BINARY NOTATION SYSTEM REQUIRES ONLY TWO NUMBERS, "0" AND "1."

bols for all numbers. Computer service usually employs "zero" and "one" as these symbols. Decimal notation and binary notation for common numbers are shown in figure 5. The binary notation represents 4-digit numbers (thousands) with ten bits, and 7-digit numbers (millions) with 20 bits. Only one electron tube is required to display an information bit. The savings in components and primary power drain of a binary-type computer over the older ENIAC-type computer is obvious. Figure 6 illustrates a computer board showing the binary indications from one to ten.

Digital Computer Uses The digital computer is employed in a "yes-no" situation. It may be used for routine calculations that would ordinarily require enormous man-hours of time, such as checking stress estimates in aircraft design, or military logistics, and problems involving the manipulation of large masses of figures.

DECIMAL NOTATION	COMPUTER NOTATION
0	● ● ● ●
1	● ● ● ○
2	● ● ○ ●
3	● ● ○ ○
4	● ○ ● ●
5	● ○ ● ○
6	● ○ ○ ●
7	● ○ ○ ○
8	○ ● ● ●
9	○ ● ● ○
10	○ ● ○ ●

● = OFF ○ = ON

Figure 6
BINARY NOTATION AS REPRESENTED ON COMPUTER BOARD FOR NUMBERS FROM 1 TO 10.

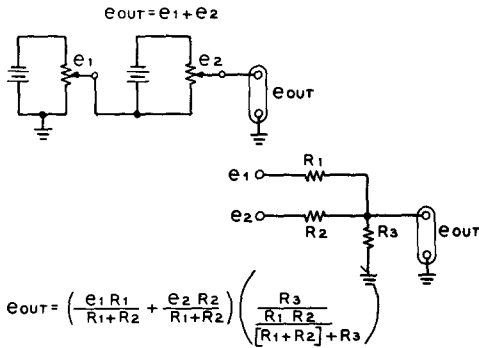

Figure 7
SUMMATION OF TWO VOLTAGES
BY ELECTRICAL MEANS.

11-3 Analog Computers

The *analog computer* represents the use of one physical system as a model for a second system that is usually more difficult to construct or to measure, and that obeys the equations of the same form. The term *analog* implies similarity of relations or properties between the two systems. The common slide-rule is a mechanical analog computer. The speedometer in an automobile is a differential analog computer, displaying information proportional to the rate of change of speed of the vehicle. The electronic analog computer employs circuits containing resistance, capacitance, and inductance arranged to behave in accordance with analogous equations. Variables are represented by d-c voltages which may vary with time.

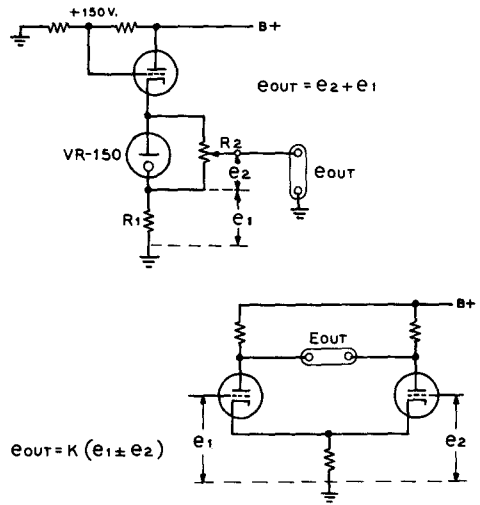

Figure 8
SUMMATION OF TWO VOLTAGES
BY ELECTRONIC MEANS.

Thus complicated problems can be solved by d-c amplifiers and potentiometer controls in electronic circuits performing mathematical functions.

Addition and Subtraction

If a linear network is energized by two voltage sources the voltages may be summed as shown in figure 7. Subtraction of quantities may be accomplished by using negative and positive voltages. A-c voltages may be employed for certain additive circuits, and more

THE HEATHKIT ELECTRONIC ANALOG DIGITAL COMPUTER

This "electronic slide rule" simulates equations or physical problems electronically, substituting one physical system as a model for a second system that is usually more difficult or costly to construct or measure, and that obeys equations of the same form.

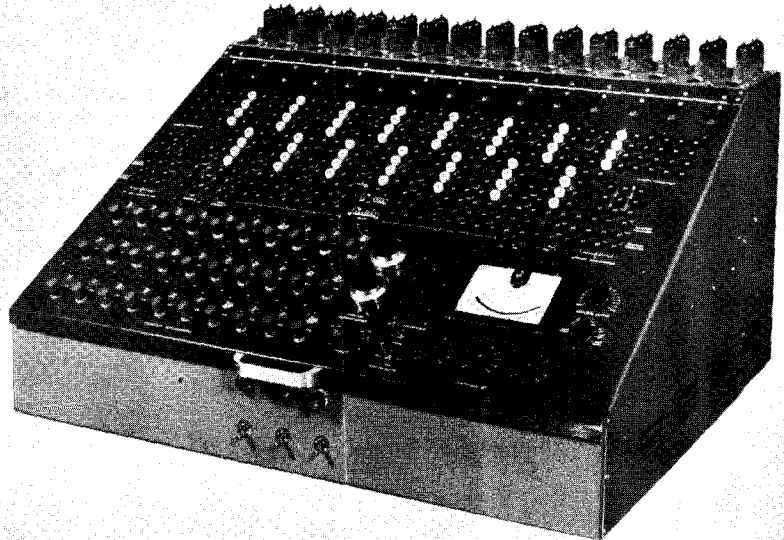

$$e_{OUT} = \frac{R_2}{R_1} \times e_1$$

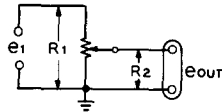

Figure 9
ELECTRONIC MULTIPLICATION
MAY BE ACCOMPLISHED BY
CALIBRATED POTENTIOMETERS,
WHEN OUTPUT VOLTAGE IS
PROPORTIONAL TO THE INPUT
VOLTAGE MULTIPLIED BY A
CONSTANT (R₂/R₁).

complex circuits employ vacuum tubes, as in figure 8. Synchronous transformers may be used to add expressions of angular rotation, and circuits have been developed for adding time delays, or pulse counting.

Multiplication and Division Electronic multiplication and division may be accomplished with the use of potentiometers where the output voltage is proportional to the input voltage multiplied by a constant which may be altered by changing the physical arrangement of the potentiometer (figure 9). Variable autotransformers may also be used to perform multiplication.

A simple bridge may be used to obtain an output that is the product of two inputs divided by a third input, as shown in figure 10.

Differentiation The time derivative of a voltage can be expressed as a charge on a capacitor by:

$$i = C \frac{de}{dt} \quad (1)$$

and is shown in figure 11A. The charging current is converted into a voltage by the use of a resistor, R. If the input to the RC circuit is charging at a uniform rate so that the current through C and R is constant, the output voltage e_o is:

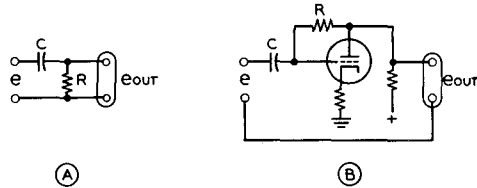

Figure 11
ELECTRONIC DIFFERENTIATION

The time derivative of a voltage can be expressed as a charge on a capacitor (A). Operational amplifier (B) employs feedback principle for short differentiation time.

$$e_o = RC \frac{de}{dt} \quad (2)$$

For highest accuracy, a *small* RC product should be used, permitting the maximum possible differentiation time. The output of the differentiator may be amplified to any suitable level.

A more accurate differentiating device makes use of an *operational amplifier*. This unit is a high gain, negative feedback d-c amplifier (discussed in section 11-4) with the resistance portion of the RC product appearing in the feedback loop of the amplifier (figure 11B). A shorter differentiation time may be employed if the junction point between R and C could be held at a constant potential. The feedback amplifier shown inverts the output signal and applies it to the RC network, holding the junction potential constant.

Integration Integration is a process of accumulation, or summation, and requires a device capable of storing physical quantities. A capacitor will store an electrical charge and will give the time integral of a current in respect to a voltage:

$$e_o = \frac{1}{C} \int i dt \quad (3)$$

In most computers, the input signal is in the form of a voltage, and the input charging current of the capacitor must be taken through a series resistance as in figure 12. If the integrating time is short the charging current is approximately proportional to the input voltage. The charging current may be made a true measure of the input voltage by the use

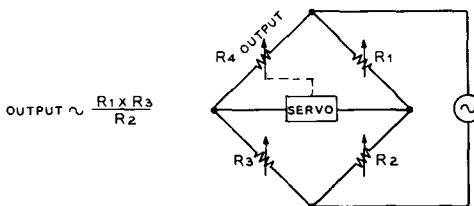
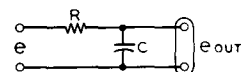

Figure 10
ELECTRONIC MULTIPLICATION BY
BRIDGE CIRCUIT PROVIDES
OUTPUT THAT IS PRODUCT OF
TWO INPUTS DIVIDED BY A
THIRD INPUT.

Figure 12
SIMPLE
INTEGRATION
CIRCUIT

Making use of charging current of capacitor.



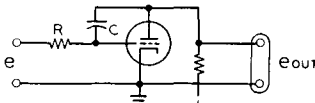

Figure 13
"MILLER FEEDBACK" INTEGRATOR
SUITABLE FOR COMPUTER USE.

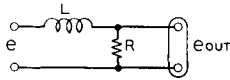

Figure 14
R-L NETWORK USED FOR
INTEGRATION PURPOSES.

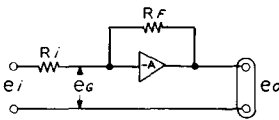

Figure 15
OPERATIONAL AMPLIFIER (-A)

Mathematical operations may be performed by any operational amplifier, usually a stable, high-gain d-c amplifier, such as shown in Figure 16.

of an operational amplifier wherein the capacitance portion of the RC product appears in the feedback loop of the amplifier, holding the junction point between R and C at a constant potential. A simple integrator is shown in figure 13 employing the *Miller feedback* principle. Integration is also possible with an RL network (figure 14).

11-4 The Operational Amplifier

Mathematical operations are performed by using a high gain d-c amplifier, termed an *operational amplifier*. The symbol of this unit is a triangle, with the apex pointing in the direction of operation (figure 15). The gain of such an amplifier is $-A$, so:

$$e_o = -Ae_e, \text{ or } e_e = -\frac{e_o}{A} \quad (4)$$

If $-A$ approaches infinity, e_e will be approximately zero. In practice this condition is realized by using amplifiers having open loop gains of 30,000 to 60,000. If e_o is set at 100 volts, e_e will be of the order of a few millivolts. Thus, considering e_e equal to zero:

$$\frac{e_o}{R_i} = -\frac{e_o}{R_f}, \text{ or } e_o = -\frac{R_f}{R_i} e_i \quad (5)$$

which may be written:

$$e_o = -Ke_i, \text{ where } K = \frac{R_f}{R_i} \quad (6)$$

This amounts to multiplication by a constant coefficient, since R_i and R_f may be fixed in value. The circuit of a typical operational amplifier is shown in figure 16.

Amplifier Operation Two voltages may be added by the amplifier, as shown in figure 17. Keeping in mind that e_e is

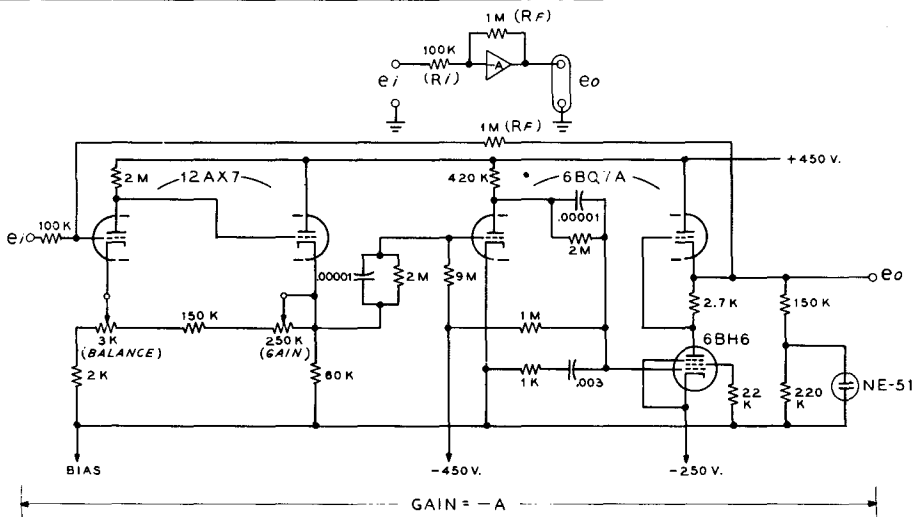

Figure 16
HIGH GAIN OPERATIONAL AMPLIFIER, SUCH AS USED IN HEATH COMPUTER.

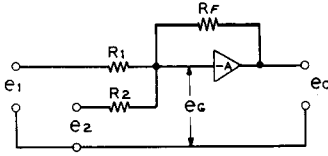

Figure 17
TWO VOLTAGES MAY BE ADDED BY SUMMATION AMPLIFIER.

essentially at zero (ground) potential:

$$e_o = - \frac{R_f}{R_1} e_1 + \frac{R_f}{R_2} e_2 \quad (7)$$

$$\text{or, } e_o = - K_1 e_1 + K_2 e_2 \quad (8)$$

$$\text{where } K_1 = \frac{R_f}{R_1} \text{ and } K_2 = \frac{R_f}{R_2} \quad (9)$$

As long as e_o does not exceed the input range of the amplifier, any number of inputs may be used:

$$e_o = - \frac{R_f}{R_1} e_1 + \frac{R_f}{R_2} e_2 + \dots + \frac{R_f}{R_n} e_n \quad (10)$$

$$\text{or } e_o = - R_f \left(\frac{e_1}{R_1} + \dots + \frac{e_n}{R_n} \right) \quad (11)$$

Integration is performed by replacing the feedback resistor R_f with a capacitor C_f , as shown in figure 18. For this circuit (with e_g approximately zero):

$$i = \frac{d_g}{dt} = \frac{e_i}{R_i} \quad (12)$$

$$\text{but } g=C_f e_o, \text{ so } \frac{d_g}{dt} = C_f \frac{de_o}{dt} \text{ and } \frac{e_i}{R_i} = C_f \frac{de_o}{dt} \quad (13)$$

$$\text{Thus: } de_o = \frac{1}{R_i C_f} e_i dt \quad (14)$$

$$\text{and } e_o = \frac{1}{R_i C_f} e_i dt \quad (15)$$

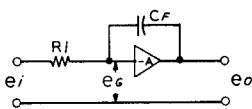

Figure 18
INTEGRATION
Performed by Summation Amplifier by replacing feed back resistor with a capacitor.

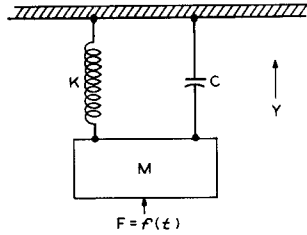

Figure 19
"MASS-SPRING-DAMPER" PROBLEM MAY BE SOLVED BY ELECTRICAL ANALOGY WITH SIMPLE COMPUTER.

11-5 Solving Analog Problems

By combining the above operations in various ways, problems of many kinds may be solved. For example, consider the mass-spring-damper assembly shown in figure 19. The mass M is connected to the spring which has an elastic constant K . The viscous damping constant is C . The vertical displacement is y . The sum of the forces acting on mass M is:

$$f(t) = M \frac{d^2 y}{dt^2} + C \frac{dy}{dt} + Ky \quad (16)$$

where $f(t)$ is the applied force, or *forcing function*.

The first step is to set up the analog computer circuit so as to obtain an output voltage proportional to y for a given input voltage proportional to $f(t)$. Equation (16) may be rewritten in the form:

$$M \frac{d^2 y}{dt^2} = - C \frac{dy}{dt} - Ky + f(t) \quad (17)$$

If, in the analog circuit, there is a voltage equal to $M \frac{d^2 y}{dt^2}$ it can be converted to $-\frac{dy}{dt}$ by passing it through an integrator circuit having an RC time constant equal to M . This resulting voltage can be passed through a second integrator stage with unit time constant which will have an output voltage equal to y . The voltages representing y , $-\frac{dy}{dt}$, and $f(t)$ can

then be summed to give $-C \frac{dy}{dt} - Ky + f(t)$ which is the right hand side of equation (17), and therefore equal to $M \frac{d^2 y}{dt^2}$. Connecting the

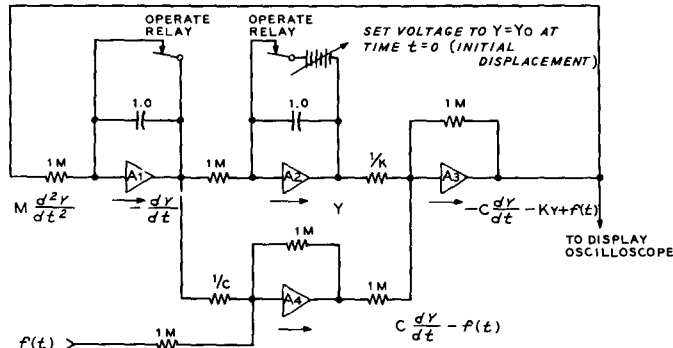

Figure 20
ANALOG SOLUTION FOR "MASS-SPRING-DAMPER" PROBLEM OF FIGURE 19.

output of the *summing amplifier* (A3) to the input of the first as shown in figure 20 satisfies the equation.

To obtain a solution to the problem, the initial displacement and velocity must be specified. This is done by charging the integrating capacitors to the proper voltages. Three operational amplifiers and a summing amplifier are required.

A second problem that may be solved by the analog computer is the example of a freely falling body. Disregarding air resistance, the body will fall (due to the action of gravity) with a constant acceleration. The equation describing this action is:

$$F = mg = m \frac{d^2y}{dt^2} \quad (18)$$

Integration of equation (18) will give the velocity, or $\frac{dy}{dt}$, and integration a second time will give displacement, or y . The block diagram of a suitable computer for this problem is shown in figure 21.

If a voltage proportional to g and hence to $\frac{d^2y}{dt^2}$ is introduced into the first amplifier, the output of that unit will be $-\frac{dy}{dt}$, or the

velocity. That, in turn, will become y , or distance, at the output of the second amplifier.

Before the problem can be solved on the computer it is necessary to determine the time of solution desirable and the output amplitude of the solution. The time of solution is determined by the RC constant of the integrating amplifiers. If RC is set at unity, computer time is equal to real time. The computer time desirable is determined by the method of *read-out*. When using an oscilloscope for read-out, a short solution time is desirable. For a recorder, longer solution time is better.

Suppose, for example, in the problem of the falling body, the distance of fall in 2.5 seconds is desired. Using an RC constant of 1 would give a solution time of 2.5 seconds. This would be acceptable for a recorder but is slow for an oscilloscope. A convenient time of solution for the scope would be 25 milliseconds. This is 1/100 of the real time, so an RC constant of .01 is needed. This can be obtained with C equal to 0.1 μ fd, and R equal to 100,000 ohms.

It is now necessary to choose an input voltage which will not overdrive the amplifiers. The value of g is known to be approximately 32 ft/sec./sec. A check indicates that if we set g equal to 32 volts, the voltage representing the answer will exceed 100 volts. Since the linear response of the amplifier is only 100 volts, this is undesirable. An input of 16 volts, however, should permit satisfactory operation of the amplifiers. Output voltages near zero should also be avoided. In general, output voltage should be about 50 volts or so, with amplifier gains of 20 to 60 being preferable. Thus, for this particular problem the time-scale factor and amplitude-scale factor have

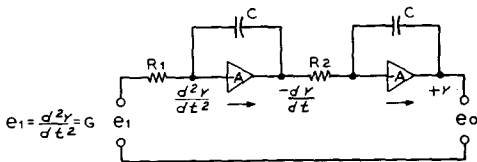

Figure 21
ANALOG COMPUTER FOR "FREELY FALLING BODY" PROBLEM.

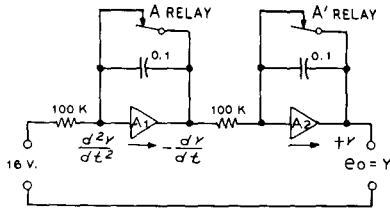

Figure 22
ANALOG SOLUTION FOR
"FALLING BODY PROBLEM"
OF FIGURE 21.

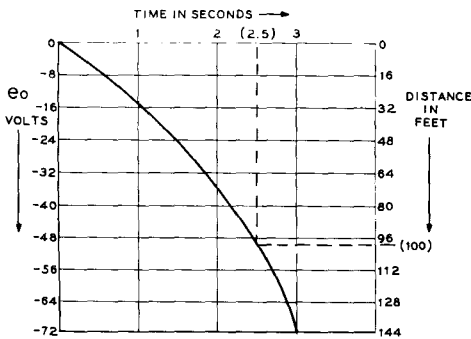

Figure 23
READ-OUT SOLUTION OF "FREELY
FALLING BODY" PROBLEM.

been chosen. The problem now looks like figure 22.

To solve the problem, relays A and A' are opened. The solution should now appear on the oscilloscope as shown in figure 23. The solution of the problem leaves the integrating capacitors charged. It is necessary to remove this charge before the problem can be rerun. This is done by closing relays A and A'.

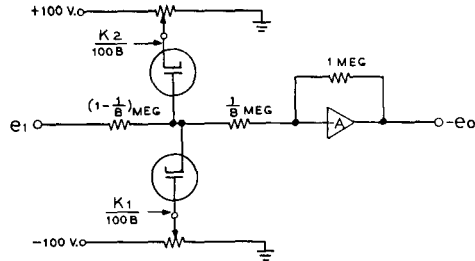

Figure 24
LIMITING CIRCUIT TO SIMULATE
NON-LINEAR FUNCTIONS SUCH AS
ENCOUNTERED IN HYSTERESIS,
BACKLASH, AND FRICTION
PROBLEMS.

11-6 Non-linear Functions

Problems are frequently encountered in which non-linear functions must be simulated. Non-linear potentiometers may be used to supply an unusual voltage source, or diodes may be used as limiters in those problems in which a function is defined differently for different regions of the independent variable. Such a function might be defined as follows:

$$e_0 = -K_1, e_1 - K_1 \quad (19)$$

$$e_0 = e_1, -K_1 \leq e_1 \leq K_2 \quad (20)$$

$$e_0 = K_2, e_1 > K_2 \quad (21)$$

where K_1 and K_2 are constants.

Various limiting circuits can be used, one of which is shown in figure 24. This is a series limiter circuit which is simple and does not require special components. Commonly encountered problems requiring these or similar limiting techniques include hysteresis, backlash, and certain types of friction.

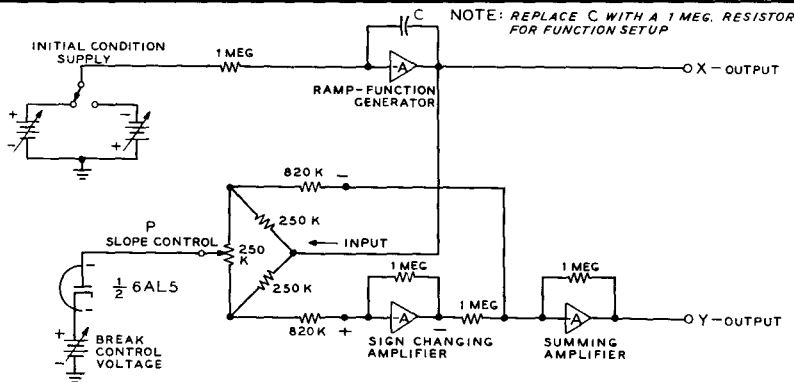

Figure 25
SIMPLIFIED DIAGRAM OF FUNCTIONAL GENERATOR TO APPROXIMATE NON-LINEAR FUNCTIONS.

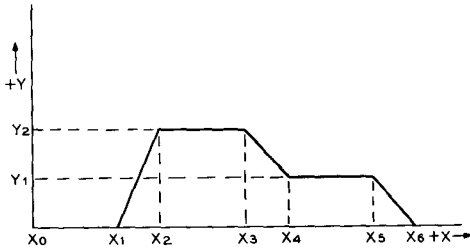

Figure 26
TYPICAL NON-LINEAR FUNCTION WHICH MAY BE SET UP WITH FUNCTION GENERATOR.

The Function Generator A function generator may be used to approximate almost any non-linear function. This is done by use of straight line segments which are combined to approximate curves such as are found in trigonometric functions as well as in stepped functions. In a typical generator ten line segments are used, five in the *plus-x* direction, and five in the *minus-x* direction. Five 6AL5 double diodes are used. Each line segment is generated by a modified bridge circuit (figure 25). A ramp function or voltage is fed into one arm of the bridge while the opposite arm is connected to a biased diode. The other two arms of the bridge combine to form the output. The voltage appearing across one of these arms is fed through a sign-changing amplifier and then summed with the voltage appearing at the opposite arm. If the arm of potentiometer P (the slope control) is set in the center, the bridge will be balanced and

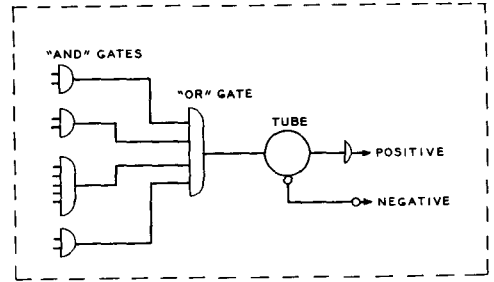

Figure 27
ELECTRONIC PACKAGE IN DIGITAL COMPUTER.

Stylized diagram of tube package. Lines carrying negative pulses are marked by a small circle at each end. Gates are indicated by a semi-circle with "pins" for each input.

the output of the summing amplifier will be zero. If, on the other hand, potentiometer P is adjusted one way or the other from center, the bridge will be unbalanced and the summing amplifier output will vary linearly with respect to the input in either a positive or negative *y* direction, depending upon which side of center potentiometer P is set.

The *break voltage*, or value of *x* at which a straight line segment will begin is set by biasing the diode to the particular voltage level or value of *x* desired. The ramp function generator has either a positive or negative input which because of the 180 degree phase shift in the amplifier, gives a *minus-* or *plus-x* output respectively. A typical function such as shown in figure 26 may be set up with the function generator. The *initial condition* volt-

IBM's new "608," the first completely transistorized calculator for commercial applications, operates without the use of a single vacuum tube. Transistors—tiny germanium devices that perform many of the functions of conventional vacuum tubes—make possible 50% reduction in computer-unit size and a 90% reduction in power requirements over a comparable IBM tube-model machine. They are mounted, along with related circuitry, on banks of printed wiring panels in the 608.

The machine's internal storage, or "memory," is made up of magnetic cores—minute, doughnut-shaped objects that can "remember" information indefinitely, and recall it for use in calculations in a few millionths of a second.

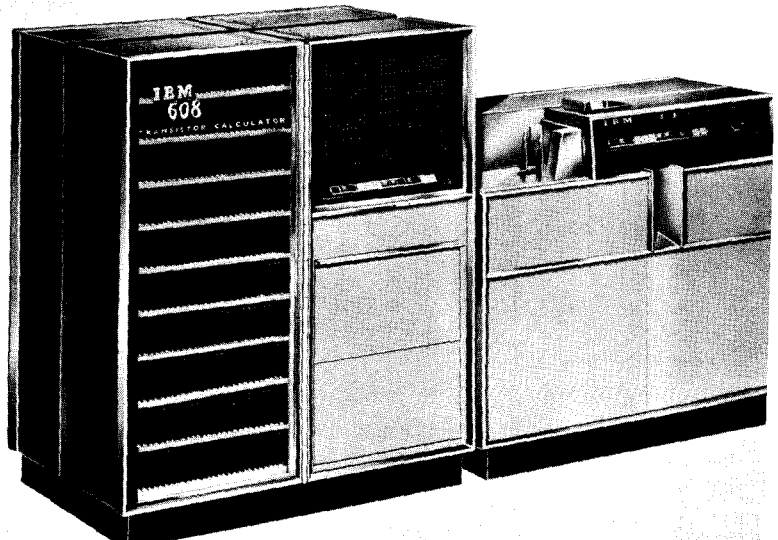

age is set to the value of X_1 . The break-voltage control is increased until the output of the summing amplifier increases abruptly, indicating the diode is conducting. The input voltage from the initial condition power supply is set to the value X_2 . The slope control (P) is now set to value Y_2 . A second function generator may be used to set points X_3 and X_4 , using the break-voltage control and the initial condition voltage adjustments. Points X_5 and X_6 are finally set with a third generator. The x-output of the function generator system may be read on an oscilloscope, using the x-output of the ramp-function generator amplifier as the horizontal sweep for the oscilloscope.

11-7 Digital Circuitry

Digital circuits dealing with "and," "or," and "not" situations may be excited by electrical pulses representing these logical operations. Sorting and amplifying the pulses can be accomplished by the use of electronic packages, such as shown in figure 27. Logical operations may be accomplished by *diode-resistor gates* operating into an amplifier stage. Negative and positive output pulses from the amplifier are obtained through diode *output gates*. The driving pulses may be obtained from a standard oscillator, operating at or near 1 mc.

A circuit of a single *digital package* is shown in figure 28. Other configurations, such as a "flip-flop" may be used. Many such packages

can be connected in series to form operational circuits. The input "and" and "or" gates are biased to conduction by external voltages. The "and" diode gate transmits a pulse only when all the input terminals are pulsed positively, and the "or" diode gate transmits a positive pulse applied to any one of its input terminals. The input pulses pass through the gates and drive the amplifier stage, which delivers an amplified pulse to the positive and negative output gates, and to accompanying memory circuits.

Memory Circuits A *memory circuit* consists of some sort of delay line which is capable of holding an information pattern for a period of time. A simple electrical delay line capable of holding a pulse for a fraction of a microsecond is shown in figure 29. The amount of delay is proportional to the frequency of the input signal as shown in the graph. A "long" transmission line may also be used as a delay line, with the signal being removed from the "far" end of the line after being delayed an interval equal to the time of transmission along the line. Lines of this type are constructed much in the manner of a standard coaxial cable, except that the inner conductor is a long, thin coil as illustrated in figure 30. Other memory circuits make use of magnetostrictive or piezoelectric effects to retard the pulse. Information may also be stored in electrostatic storage tubes, upon mag-

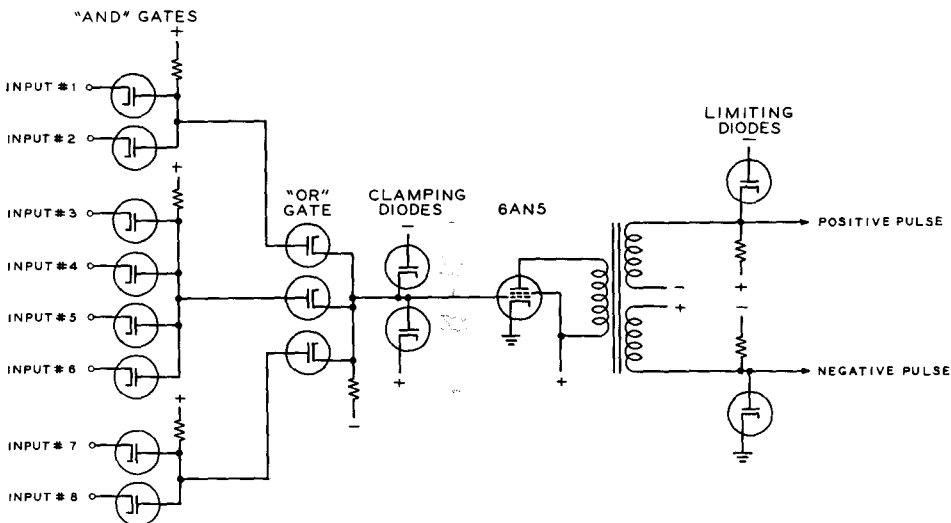

Figure 28
TYPICAL DIGITAL PACKAGE SHOWING INPUT AND OUTPUT DIODE GATES AND PULSE AMPLIFIER.

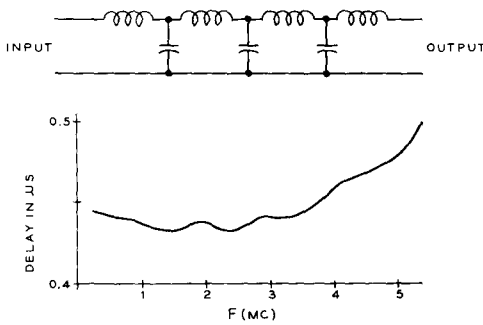

Figure 29
SIMPLE DELAY LINE COMPOSED OF
LUMPED INDUCTANCE AND
CAPACITANCE. GRAPH SHOWS HOW
DELAY TIME VARIES WITH
FREQUENCY OF INPUT PULSE.

netic recording tape, and in ferromagnetic cores. Experimental magnetic cores have been developed that will permit construction of

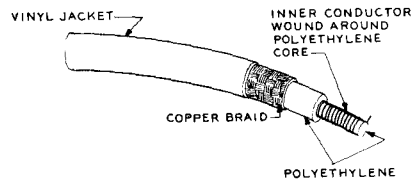

Figure 30
UNIFORM DELAY LINE BEARS
RESEMBLANCE TO COAXIAL CABLE,
EXCEPT FOR COILED INNER
CONDUCTOR.

memories capable of retaining over 10,000 separate bits of information. The memory may be "read" or "interrogated" by sending pulses through the matrix and observing the resulting induced voltage in a secondary circuit. The output from the memory circuit may be used to excite a program control system, permitting the computer to drive another mechanism in the proper sequence.

E & E TECHNI-SHEET

TABLE OF ALUMINUM TUBING, ROUND DRAWN, 12 FOOT LENGTHS

3S-H14 TUBING			24S-T3 TUBING			61S-T6 TUBING		
DIAM.	WALL	WT.#/FT.	DIAM.	WALL	WT.#/FT.	DIAM.	WALL	WT.#/FT.
3/16"	.022"	.013	1/4"	.035"	.028	3/16"	.035"	.018
1/4"	.022"	.018	3/8"	.049"	.060	1/4"	.035"	.028
1/4"	.035"	.028	1/2"	.035"	.061	1/4"	.058"	.041
3/8"	.022"	.028	5/8"	.035"	.078	5/16"	.035"	.036
3/8"	.035"	.060	3/4"	.035"	.094	5/16"	.058"	.055
1/2"	.035"	.060	3/4"	.049"	.130	3/8"	.035"	.044
1/2"	.049"	.083	7/8"	.049"	.151	3/8"	.058"	.068
1/2"	.065"	.105	1"	.035"	.128	3/8"	.065"	.074
5/8"	.035"	.076	1"	.049"	.175	7/16"	.035"	.052
5/8"	.049"	.104	1"	.065"	.228	7/16"	.065"	.089
5/8"	.065"	.133	1 1/4"	.049"	.221	1/2"	.028"	.049
3/4"	.035"	.092	1 1/2"	.035"	.193	1/2"	.035"	.060
3/4"	.049"	.128	1 1/2"	.049"	.268	1/2"	.058"	.095
3/4"	.058"	.149	1 1/2"	.065"	.351	1/2"	.065"	.104
3/4"	.065"	.166	2"	.065"	.473	5/8"	.035"	.076
7/8"	.035"	.110				5/8"	.058"	.121
7/8"	.049"	.150				3/4"	.035"	.092
7/8"	.058"	.177				3/4"	.058"	.148
7/8"	.065"	.196				3/4"	.083"	.204
1"	.035"	.126				7/8"	.035"	.109
1"	.049"	.174				7/8"	.058"	.175
1"	.058"	.204				1"	.035"	.125
1"	.065"	.216				1"	.058"	.202
<p>3S-H14 ALUMINUM TUBING - CAN BE BENT OR FLATTENED READILY.</p> <p>24S-T3 ALUMINUM TUBING - HAS HIGH TENSILE STRENGTH AND CAN BE BENT OR FLATTENED ONLY SLIGHTLY WITHOUT CRACKING. GOOD FOR ANTENNA MASTS, BOOMS, ELEMENTS AND OTHER SECTIONS REQUIRING STRENGTH AND RIGIDITY.</p> <p>61S-T6 ALUMINUM TUBING - HAS GREAT TENSILE STRENGTH BUT CANNOT BE FLATTENED OR BENT.</p>						1"	.083"	.281
						1 1/4"	.058"	.256
						1 1/4"	.083"	.357
						1 3/8"	.058"	.282
						1 1/2"	.058"	.309
						1 1/2"	.083"	.510
						2"	.058"	.416
2"	.083"	.590						

Radio Receiver Fundamentals

A conventional reproducing device such as a loudspeaker or a pair of earphones is incapable of receiving directly the intelligence carried by the *carrier* wave of a radio transmitting station. It is necessary that an additional device, called a *radio receiver*, be placed between the receiving antenna and the loudspeaker or headphones.

Radio receivers vary widely in their complexity and basic design, depending upon the intended application and upon economic factors. A simple radio receiver for reception of radiotelephone signals can consist of an earphone, a silicon or germanium crystal as a carrier rectifier or *demodulator*, and a length of wire as an antenna. However, such a receiver is highly insensitive, and offers no significant discrimination between two signals in the same portion of the spectrum.

On the other hand, a dual-diversity receiver designed for single-sideband reception and employing double or triple detection might occupy several relay racks and would cost many thousands of dollars. However, conventional communications receivers are intermediate in complexity and performance between the two extremes. This chapter is devoted to the principles underlying the operation of such conventional communications receivers.

12-1

Detection or Demodulation

A detector or demodulator is a device for removing the modulation (demodulating) or detecting the intelligence carried by an incoming radio wave.

Radiotelephony Demodulation Figure 1 illustrates an elementary form of radiotelephony receiver employing a diode detector. Energy from a passing radio wave will induce a voltage in the antenna and cause a radio-frequency current to flow from antenna to ground through coil L_1 . The alternating magnetic field set up around L_1 links with the turns of L_2 and causes an r-f current to flow through the parallel-tuned circuit, L_2 - C_1 . When variable capacitor C_1 is adjusted so that the tuned circuit is resonant at the frequency of the applied signal, the r-f voltage is maximum. This r-f voltage is applied to the diode detector where it is rectified into a varying direct current and passed through the earphones. The variations in this current correspond to the voice modulation placed on the signal at the transmitter. As the earphone diaphragms vibrate back and forth in accord-

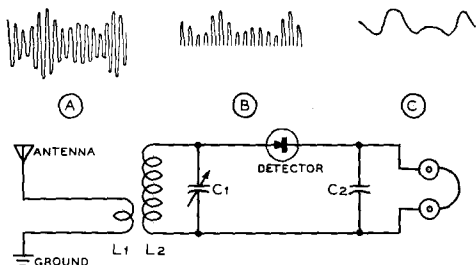

Figure 1

ELEMENTARY FORM OF RECEIVER

This is the basis of the "crystal set" type of receiver, although a vacuum diode may be used in place of the crystal diode. The tank circuit L_2-C_1 is tuned to the frequency it is desired to receive. The by-pass capacitor across the phones should have a low reactance to the carrier frequency being received, but a high reactance to the modulation on the received signal.

ance with the pulsating current they audibly reproduce the modulation which was placed upon the carrier wave.

The operation of the detector circuit is shown graphically above the detector circuit in figure 1. The modulated carrier is shown at A, as it is applied to the antenna. B represents the same carrier, increased in amplitude, as it appears across the tuned circuit. In C the varying d-c output from the detector is seen.

Radiotelegraphy
Reception

Since a c-w telegraphy signal consists of an unmodulated carrier which is interrupted to form dots and dashes, it is apparent that such a signal would not be made audible by detection alone. While the keying is a form of modulation, it is composed of such low frequency components that the keying envelope itself is below the audible range for hand keying speeds. Some means must be provided whereby an audible tone is heard while the unmodulated carrier is being received, the tone stopping immediately when the carrier is interrupted.

The most simple means of accomplishing this is to feed a locally generated carrier of a slightly different frequency into the same detector, so that the incoming signal will mix with it to form an audible beat note. The difference frequency, or heterodyne as the beat note is known, will of course stop and start in accordance with the incoming c-w radiotelegraph signal, because the audible heterodyne can exist only when both the incoming and the locally generated carriers are present.

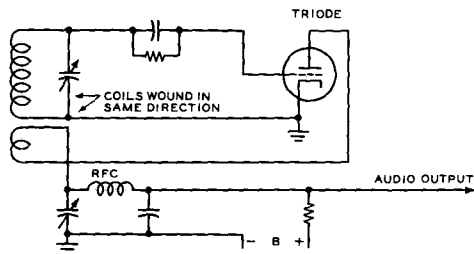
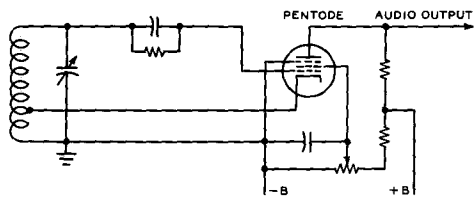

PLATE-TICKLER REGENERATION WITH "THROTTLE" CONDENSER REGENERATION CONTROL.



CATHODE-TAP REGENERATION WITH SCREEN VOLTAGE REGENERATION CONTROL.

Figure 2

REGENERATIVE DETECTOR CIRCUITS

Regenerative detectors are seldom used at the present time due to their poor selectivity. However, they do illustrate the simplest type of receiver which may be used either for radiophone or radiotelegraph reception.

The Autodyne
Detector

The local signal which is used to beat with the desired c-w signal in the detector may be supplied by a separate low-power oscillator in the receiver itself, or the detector may be made to self-oscillate, and thus serve the dual purpose of detector and oscillator. A detector which self-oscillates to provide a beat note is known as an autodyne detector, and the process of obtaining feedback between the detector plate and grid is called regeneration.

An autodyne detector is most sensitive when it is barely oscillating, and for this reason a regeneration control is always included in the circuit to adjust the feedback to the proper amount. The regeneration control may be either a variable capacitor or a variable resistor, as shown in figure 2.

With the detector regenerative but not oscillating, it is also quite sensitive. When the circuit is adjusted to operate in this manner, modulated signals may be received with considerably greater strength than with a non-regenerative detector.

12-2 Superregenerative Receivers

At ultra-high frequencies, when it is desired to keep weight and cost at a minimum, a special form of the regenerative receiver known as the *superregenerator* is often used for radiotelephony reception. The superregenerator is essentially a regenerative receiver with a means provided to throw the detector rapidly in and out of oscillation. The frequency at which the detector is made to go in and out of oscillation varies with the frequency to be received, but is usually between 20,000 and 500,000 times a second. This superregenerative action considerably increases the sensitivity of the oscillating detector so that the usual "background hiss" is greatly amplified when no signal is being received. This hiss diminishes in proportion to the strength of the received signal, loud signals eliminating the hiss entirely.

Quench Methods There are two systems in common use for causing the detector to break in and out of oscillation rapidly. In one, a separate *interruption-frequency* oscillator is arranged so as to vary the voltage rapidly on one of the detector tube elements (usually the plate, sometimes the screen) at the high rate necessary. The interruption-frequency oscillator commonly uses a conventional tickler-feedback circuit with coils appropriate for its operating frequency.

The second, and simplest, type of superregenerative detector circuit is arranged so as to produce its own interruption frequency oscillation, without the aid of a separate tube. The detector tube damps (or "quenches") itself out of signal-frequency oscillation at a high rate by virtue of the use of a high value of grid leak and proper size plate-blocking and grid capacitors, in conjunction with an excess of feedback. In this type of "self-quenched" detector, the grid leak is quite often returned to the positive side of the power supply (through the coil) rather than to the cathode. A representative self-quenched superregenerative detector circuit is shown in figure 3.

Except where it is impossible to secure sufficient regenerative feedback to permit superregeneration, the self-quenching circuit is to be preferred; it is simpler, is self-adjusting as regards quenching amplitude, and can have good quenching wave form. To obtain as good results with a separately quenched superregenerator, very careful design is required. However, separately quenched circuits are useful when it is possible to make a certain tube oscillate on a very high frequency but it is impossible to obtain enough regeneration for self-quenching action.

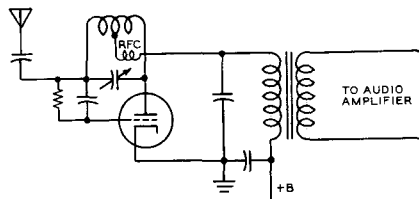

Figure 3
SUPERREGENERATIVE DETECTOR CIRCUIT

A self-quenched superregenerative detector such as illustrated above is capable of giving good sensitivity in the v-h-f range. However, the circuit has the disadvantage that its selectivity is relatively poor. Also, such a circuit should be preceded by an r-f stage to suppress the radiation of a signal by the oscillating detector.

The optimum quenching frequency is a function of the signal frequency. As the operating frequency goes up, so does the optimum quenching frequency. When the quench frequency is too low, maximum sensitivity is not obtained. When it is too high, both sensitivity and selectivity suffer. In fact, the optimum quench frequency for an operating frequency below 15 Mc. is in the audible range. This makes the superregenerator impracticable for use on the lower frequencies.

The high background noise or hiss which is heard on a properly designed superregenerator when no signal is being received is not the quench frequency component; it is tube and tuned circuit fluctuation noise, indicating that the receiver is extremely sensitive.

A moderately strong signal will cause the background noise to disappear completely, because the superregenerator has an inherent and instantaneous automatic volume control characteristic. This same a-v-c characteristic makes the receiver comparatively insensitive to impulse noise such as ignition pulses—a highly desirable feature. This characteristic also results in appreciable distortion of a received radiotelephone signal, but not enough to affect the intelligibility.

The selectivity of a superregenerator is rather poor as compared to a superheterodyne, but is surprisingly good for so simple a receiver when figured on a percentage basis rather than absolute kc. bandwidth.

FM Reception A superregenerative receiver will receive frequency modulated signals with results comparing favorably with amplitude modulation if the frequency swing of the FM transmitter is sufficiently high. For such reception, the receiver is detuned slightly to either side of resonance.

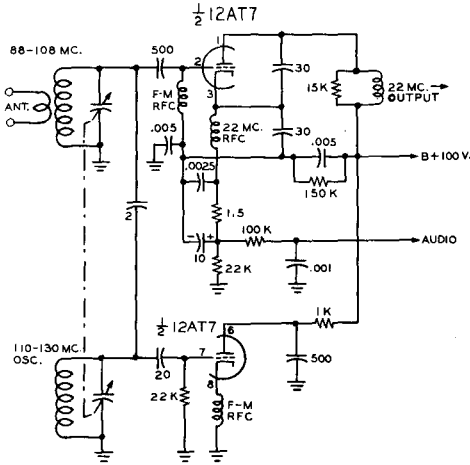

Figure 4
THE FREMODYNE SUPERREGENERATIVE SUPERHETERODYNE DETECTOR FOR FREQUENCY MODULATED SIGNALS

Superregenerative receivers radiate a strong, broad, and rough signal. For this reason, it is necessary in most applications to employ a radio frequency amplifier stage ahead of the detector, with thorough shielding throughout the receiver.

The Fremodyne Detector The Hazeltine-Fremodyne superregenerative circuit is expressly designed for reception of FM signals. This versatile circuit combines the action of the superregenerative receiver with the superheterodyne, converting FM signals directly into audio signals in one double triode tube (figure 4). One section of the triode serves as a superregenerative mixer, producing an i-f of 22 Mc., an i-f amplifier, and a FM detector. The detector action is accomplished by *slope detection* tuning on the side of the i-f selectivity curve.

This circuit greatly reduces the radiated signal, characteristic of the superregenerative detector, yet provides many of the desirable features of the superregenerator. The pass-band of the Fremodyne detector is about 400 kc.

12-3 Superheterodyne Receivers

Because of its superiority and nearly universal use in all fields of radio reception, the

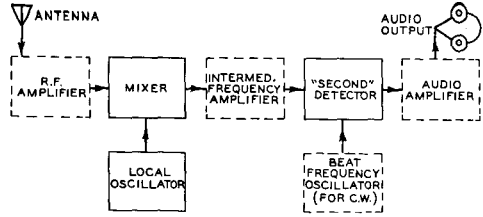

Figure 5
ESSENTIAL UNITS OF A SUPERHETERODYNE RECEIVER

The basic portions of the receiver are shown in solid blocks. Practicable receivers employ the dotted blocks and also usually include such additional circuits as a noise limiter, an a-v-c circuit, and a crystal filter in the i-f amplifier.

theory of operation of the superheterodyne should be familiar to every radio student and experimenter. The following discussion concerns superheterodynes for amplitude-modulation reception. It is, however, applicable in part to receivers for frequency modulation.

Principle of Operation In the superheterodyne, the incoming signal is applied to a mixer consisting of a non-linear impedance such as a vacuum tube or a diode. The signal is mixed with a steady signal generated locally in an oscillator stage, with the result that a signal bearing all the modulation applied to the original signal *but of a frequency equal to the difference between the local oscillator and incoming signal frequencies* appears in the mixer output circuit. The output from the mixer stage is fed into a fixed-tuned *intermediate-frequency amplifier*, where it is amplified and detected in the usual manner, and passed on to the audio amplifier. Figure 5 shows a block diagram of the fundamental superheterodyne arrangement. The basic components are shown in heavy lines, the simplest superheterodyne consisting simply of these three units. However, a good communications receiver will comprise all of the elements shown, both heavy and dotted blocks.

Superheterodyne Advantages The advantages of superheterodyne reception are directly attributable to the use of the fixed-tuned *intermediate-frequency (i-f) amplifier*. Since all signals are converted to the intermediate frequency, this section of the receiver may be designed for optimum selectivity and high amplification. High amplification is easily obtained in the intermediate-frequency amplifier, since it operates at a

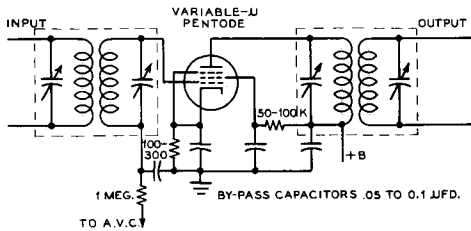

Figure 6
TYPICAL I-F AMPLIFIER STAGE

relatively low frequency, where conventional pentode-type tubes give adequate voltage gain. A typical i-f amplifier is shown in figure 6.

From the diagram it may be seen that both the grid and plate circuits are tuned. The tuned circuits used for coupling between i-f stages are known as *i-f transformers*. These will be more fully discussed later in this chapter.

Choice of Intermediate Frequency The choice of a frequency for the i-f amplifier involves several considerations. One of these considerations concerns selectivity; the lower the intermediate frequency the greater the obtainable selectivity. On the other hand, a rather high intermediate frequency is desirable from the standpoint of *image* elimination, and also for the reception of signals from television and FM transmitters and modulated self-controlled oscillators, all of which occupy a rather wide band of frequencies, making a broad selectivity characteristic desirable. Images are a peculiarity common to all superheterodyne receivers, and for this reason they are given a detailed discussion later in this chapter.

While intermediate frequencies as low as 50 kc. are used where extreme selectivity is a requirement, and frequencies of 60 Mc. and above are used in some specialized forms of receivers, most present-day communications superheterodynes use intermediate frequencies around either 455 kc. or 1600 kc.

Home-type broadcast receivers almost always use an i-f in the vicinity of 455 kc., while auto receivers usually use a frequency of about 262 kc. The standard frequency for the i-f channel of FM receivers is 10.7 Mc. Television receivers use an i-f which covers the band between about 21.5 and 27 Mc., although a new band between 41 and 46 Mc. is coming into more common usage.

Arithmetical Selectivity Aside from allowing the use of fixed-tuned band-pass amplifier stages, the superheterodyne has

an overwhelming advantage over the tuned radio frequency (t-r-f) type of receiver because of what is commonly known as *arithmetical selectivity*.

This can best be illustrated by considering two receivers, one of the t-r-f type and one of the superheterodyne type, both attempting to receive a desired signal at 10,000 kc. and eliminate a strong interfering signal at 10,010 kc. In the t-r-f receiver, separating these two signals in the tuning circuits is practically impossible, since they differ in frequency by only 0.1 per cent. However, in a superheterodyne with an intermediate frequency of, for example, 1000 kc., the desired signal will be converted to a frequency of 1000 kc. and the interfering signal will be converted to a frequency of 1010 kc., both signals appearing at the input of the i-f amplifier. In this case, the two signals may be separated much more readily, since they differ by 1 per cent, or 10 times as much as in the first case.

The Converter Stage The converter stage, or *mixer*, of a superheterodyne receiver

can be either one of two types:

(1) it may use a single envelope *converter* tube, such as a 6K8, 6SA7, or 6BE6, or (2) it may use two tubes, or two sets of elements in the same envelope, in an oscillator-mixer arrangement. Figure 7 shows a group of circuits of both types to illustrate present practice with regard to types of converter stages.

Converter tube combinations such as shown in figures 7A and 7B are relatively simple and inexpensive, and they do an adequate job for most applications. With a converter tube such as the 6SB7-Y or the 6BA7 quite satisfactory performance may be obtained for the reception of relatively strong signals (as for example FM broadcast reception) up to frequencies in excess of 100 Mc. However, the equivalent input noise resistance of such tubes is of the order of 200,000 ohms, which is a rather high value indeed. So such tubes are *not* suited for operation without an r-f stage in the high-frequency range if weak-signal reception is desired.

The 6L7 mixer circuit shown in figure 7C, and the 6BA7 circuit of figure 7D, also are characterized by an equivalent input noise resistance of several hundred thousand ohms, so that these also must be preceded by one or more r-f stages with a fairly high gain per stage if a low noise factor is desired of the complete receiver.

However, the circuit arrangements shown at figures 7F and 6F are capable of low-noise operation within themselves, so that these circuits may be fed directly from the antenna without an r-f stage and still provide a good noise factor to the complete receiver. Note

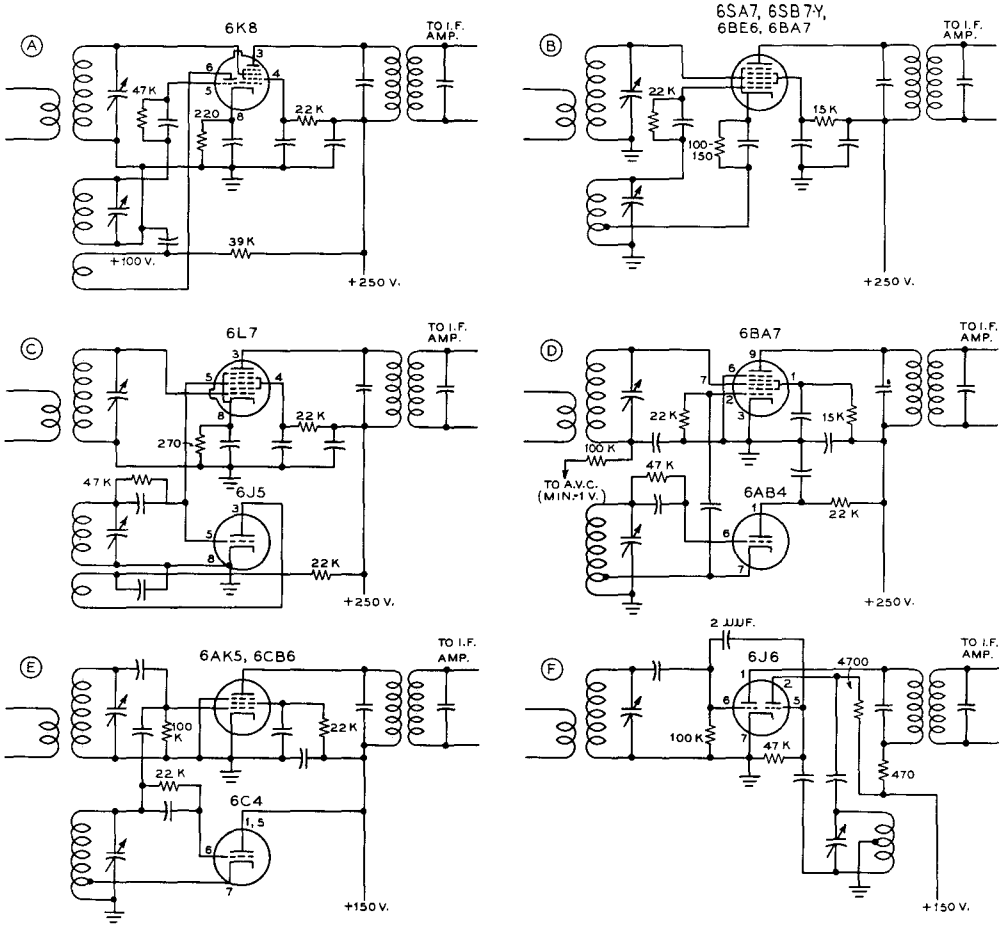

Figure 7
TYPICAL FREQUENCY-CONVERTER (MIXER) STAGES
The relative advantages of the different circuits are discussed in the text

that both these circuits use *control-grid injection* of both the incoming signal and the local-oscillator voltage. Hence, paradoxically, circuits such as these should be preceded by an r-f stage if local-oscillator radiation is to be held to any reasonable value of field intensity.

Diode Mixers As the frequency of operation of a superheterodyne receiver is increased above a few hundred megacycles the signal-to-noise ratio appearing in the plate circuit of the mixer tube when triodes or pentodes are employed drops to a prohibitively low value. At frequencies above the upper-fre-

quency limit for conventional mixer stages, mixers of the diode type are most commonly employed. The diode may be either a vacuum-tube heater diode of a special u-h-f design such as the 9005, or it may be a crystal diode of the general type of the 1N21 through 1N28 series.

12-4

Mixer Noise and Images

The effects of *mixer noise* and *images* are troubles common to all superheterodynes. Since

both these effects can largely be obviated by the same remedy, they will be considered together.

Mixer Noise Mixer noise of the shot-effect type, which is evidenced by a hiss in the audio output of the receiver, is caused by small irregularities in the plate current in the mixer stage and will mask weak signals. Noise of an identical nature is generated in an amplifier stage, but due to the fact that the conductance in the mixer stage is considerably lower than in an amplifier stage using the same tube, the proportion of inherent noise present in a mixer usually is considerably greater than in an amplifier stage using a comparable tube.

Although this noise cannot be eliminated, its effects can be greatly minimized by placing sufficient signal-frequency amplification having a high signal-to-noise ratio ahead of the mixer. This remedy causes the signal output from the mixer to be large in proportion to the noise generated in the mixer stage. Increasing the gain *after* the mixer will be of no advantage in eliminating mixer noise difficulties; greater selectivity after the mixer will help to a certain extent, but cannot be carried too far, since this type of selectivity decreases the i-f band-pass and if carried too far will not pass the sidebands that are an essential part of a voice-modulated signal.

Triode Mixers A triode having a high transconductance is the *quietest* mixer tube, exhibiting somewhat less gain but a better signal-to-noise ratio than a comparable multi-grid mixer tube. However, below 30 Mc. it is possible to construct a receiver that will get down to the atmospheric noise level without resorting to a triode mixer. The additional difficulties experienced in avoiding *pulling*, undesirable feedback, etc., when using a triode with control-grid injection tend to make multi-grid tubes the popular choice for this application on the lower frequencies.

On very high frequencies, where set noise rather than atmospheric noise limits the weak signal response, triode mixers are more widely used. A 6J6 miniature twin triode with grids in push-pull and plates in parallel makes an excellent mixer up to about 600 Mc.

Injection Voltage The amplitude of the injection voltage will affect the conversion transconductance of the mixer, and therefore should be made optimum if maximum signal-to-noise ratio is desired. If fixed bias is employed on the injection grid, the optimum injection voltage is quite critical. If cathode bias is used, the optimum voltage is not so critical; and if grid leak bias is employed, the

optimum injection voltage is not at all critical just so it is adequate. Typical optimum injection voltages will run from 1 to 10 volts for control grid injection, and 45 volts or so for screen or suppressor grid injection.

Images There always are *two* signal frequencies which will combine with a given frequency to produce the same difference frequency. For example: assume a superheterodyne with its oscillator operating on a higher frequency than the signal, which is common practice in present superheterodynes, tuned to receive a signal at 14,100 kc. Assuming an i-f amplifier frequency of 450 kc., the mixer input circuit will be tuned to 14,100 kc., and the oscillator to 14,100 plus 450, or 14,550 kc. Now, a *strong* signal at the oscillator frequency plus the intermediate frequency (14,550 plus 450, or 15,000 kc.) will also give a difference frequency of 450 kc. in the mixer output and will be heard also. Note that the image is always *twice* the intermediate frequency away from the desired signal. Images cause *repeat points* on the tuning dial.

The only way that the image could be eliminated in this particular case would be to make the selectivity of the mixer input circuit, and any circuits preceding it, great enough so that the 15,000-kc. signal never reaches the mixer grid in sufficient amplitude to produce interference.

For any particular intermediate frequency, image interference troubles become increasingly greater as the frequency to which the signal-frequency portion of the receiver is tuned is increased. This is due to the fact that the percentage difference between the desired frequency and the image frequency decreases as the receiver is tuned to a higher frequency. The ratio of strength between a signal at the image frequency and a signal at the frequency to which the receiver is tuned producing equal output is known as the *image ratio*. The higher this ratio, the better the receiver in regard to image-interference troubles.

With but a single tuned circuit between the mixer grid and the antenna, and with 400-500 kc. i-f amplifiers, image ratios of 60 db and over are easily obtainable up to frequencies around 2000 kc. Above this frequency, greater selectivity in the mixer grid circuit through the use of additional tuned circuits between the mixer and the antenna is necessary if a good image ratio is to be maintained.

12-5

R-F Stages

Since the necessary tuned circuits between the mixer and the antenna can be combined with tubes to form r-f amplifier stages, the

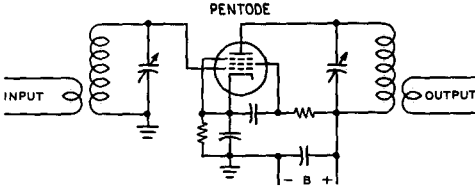

Figure 8
TYPICAL PENTODE R-F AMPLIFIER STAGE

reduction of the effects of mixer noise and the increasing of the image ratio can be accomplished in a single section of the receiver. When incorporated in the receiver, this section is known simply as an *r-f amplifier*; when it is a separate unit with a separate tuning control it is often known as a *preselector*. Either one or two stages are commonly used in the preselector or r-f amplifier. Some preselectors use regeneration to obtain still greater amplification and selectivity. An r-f amplifier or preselector embodying more than two stages rarely ever is employed since two stages will ordinarily give adequate gain to override mixer noise.

R-F Stages in the V-H-F Range Generally speaking, atmospheric noise in the frequency range above 30 Mc. is quite low—so low, in fact, that the noise generated within the receiver itself is greater than the noise received on the antenna. Hence it is of the greatest importance that internally generated noise be held to a minimum in a receiver. At frequencies much above 300 Mc. there is not too much that can be done at the present state of the art in the direction of reducing receiver noise below that generated in the converter stage. But in the v-h-f range, between 30 and 300 Mc., the receiver noise factor in a well designed unit is determined by the characteristics of the first r-f stage.

The usual v-h-f receiver, whether for communications or for FM or TV reception, uses a miniature pentode for the first r-f amplifier stage. The 6AK5 is the best of presently available types, with the 6CB6 and the 6DC6 closely approaching the 6AK5 in performance. But when gain in the first r-f stage is not so important, and the best noise factor must be obtained, the first r-f stage usually uses a triode.

Shown in figure 9 are four commonly used types of triode r-f stages for use in the v-h-f range. The circuit at (A) uses few components and gives a moderate amount of gain with very low noise. It is most satisfactory when the first r-f stage is to be fed directly from a low-

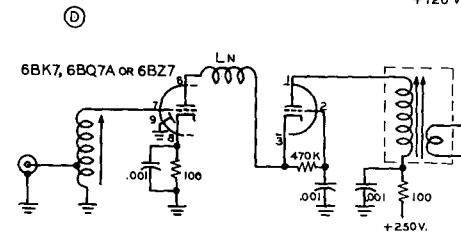
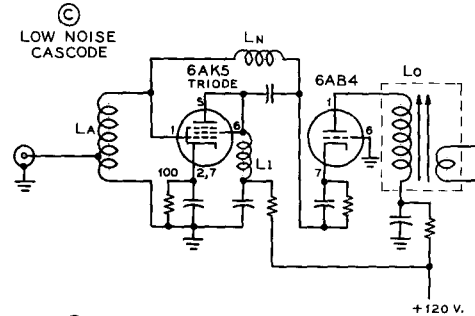
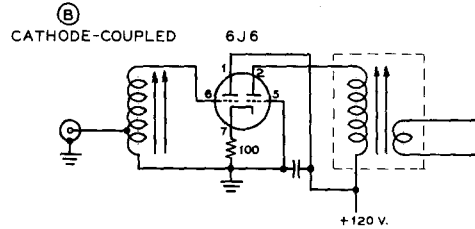
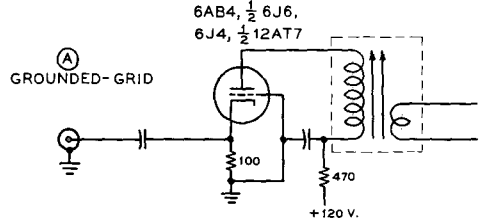

Figure 9
TYPICAL TRIODE V-H-F
R-F AMPLIFIER STAGES

Triode r-f stages contribute the least amount of noise output for a given signal level, hence their frequent use in the v-h-f range.

impedance coaxial transmission line. Figure 9 (B) gives somewhat more gain than (A), but requires an input matching circuit. The effective gain of this circuit is somewhat reduced when it is being used to amplify a broad band of frequencies since the effective G_m of the cathode-coupled dual tube is somewhat less

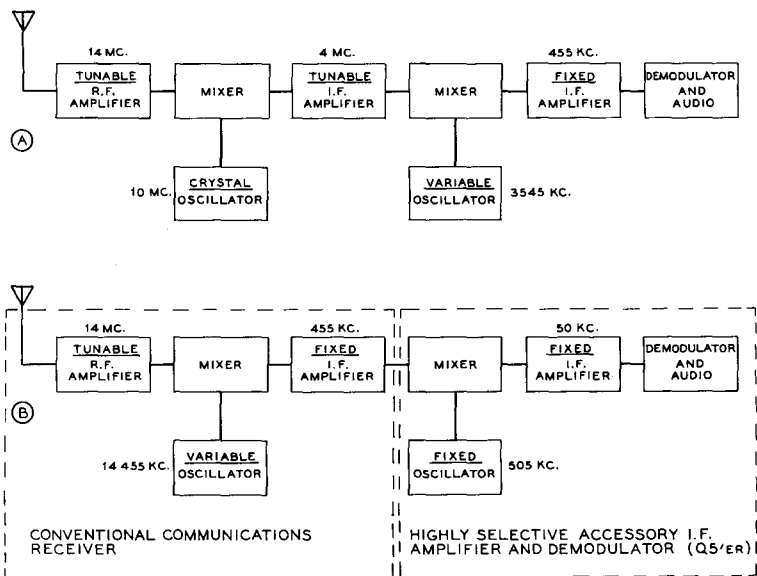

Figure 10

TYPICAL DOUBLE-CONVERSION SUPERHETERODYNE RECEIVERS

Illustrated at (A) is the basic circuit of a commercial double-conversion superheterodyne receiver. At (B) is illustrated the application of an accessory sharp i-f channel for obtaining improved selectivity from a conventional communications receiver through the use of the double-conversion principle.

than half the G_m of either of the two tubes taken alone.

The Cascode Amplifier

The Cascode r-f amplifier, developed at the MIT Radiation Laboratory during World War II, is a low noise circuit employing a grounded cathode triode driving a grounded grid triode, as shown in figure 9C. The stage gain of such a circuit is about equal to that of a pentode tube, while the noise figure remains at the low level of a triode tube. Neutralization of the first triode tube is usually unnecessary below 50 Mc. Above this frequency, a definite improvement in the noise figure may be obtained through the use of neutralization. The neutralizing coil, L_N , should resonate at the operating frequency with the grid-plate capacity of the first triode tube.

The 6BQ7A and 6BZ7 tubes are designed for use in cascode circuits, and may be used to good advantage in the 144 Mc. and 220 Mc. amateur bands (figure 9D). For operation at higher frequencies, the 6AJ4 tube is recommended.

Double Conversion As previously mentioned, the use of a higher intermediate frequency will also improve the image

ratio, at the expense of i-f selectivity, by placing the desired signal and the image farther apart. To give both good image ratio at the higher frequencies and good selectivity in the i-f amplifier, a system known as *double conversion* is sometimes employed. In this system, the incoming signal is first converted to a rather high intermediate frequency, and then amplified and again converted, this time to a much lower frequency. The first intermediate frequency supplies the necessary wide separation between the image and the desired signal, while the second one supplies the bulk of the i-f selectivity.

The double-conversion system, as illustrated in figure 10, is receiving two general types of application at the present time. The first application is for the purpose of attaining extremely good stability in a communications receiver through the use of crystal control of the first oscillator. In such an arrangement, as used in several types of Collins receivers, the first oscillator is crystal controlled and is followed by a tunable i-f amplifier which then is followed by a mixer stage and a fixed-tuned i-f amplifier on a much lower frequency. Through such a circuit arrangement the stability of the complete receiver is equal to the

stability of the oscillator which feeds the second mixer, while the selectivity is determined by the bandwidth of the second, fixed i-f amplifier.

The second common application of the double-conversion principle is for the purpose of obtaining a very high degree of selectivity in the complete communications receiver. In this type of application, as illustrated in figure 10 (B), a conventional communications receiver is modified in such a manner that its normal i-f amplifier (which usually is in the 450 to 915 kc. range) instead of being fed to a demodulator and then to the audio system, is alternatively fed to a fixed-tune mixer stage and then into a much lower intermediate frequency amplifier before the signal is demodulated and fed to the audio system. The accessory i-f amplifier system (sometimes called a Q5'er) normally is operated on a frequency of 175 kc., 85 kc., or 50 kc.

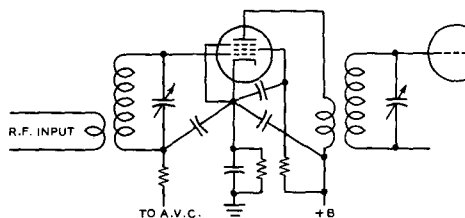

Figure 11
ILLUSTRATING "COMMON POINT"
BY-PASSING

To reduce the detrimental effects of cathode circuit inductance in v-h-f stages, all by-pass capacitors should be returned to the cathode terminal of the socket. Tubes with two cathode leads can give improved performance if the grid return is made to one cathode terminal while the plate and screen by-pass returns are made to the cathode terminal which is connected to the suppressor within the tube.

12-6 Signal-Frequency Tuned Circuits

The signal-frequency tuned circuits in high-frequency superheterodynes and tuned radio frequency types of receivers consist of coils of either the solenoid or universal-wound types shunted by variable capacitors. It is in these tuned circuits that the causes of success or failure of a receiver often lie. The universal-wound type coils usually are used at frequencies below 2000 kc.; above this frequency the single-layer solenoid type of coil is more satisfactory.

Impedance and Q The two factors of greatest significance in determining the gain-per-stage and selectivity, respectively, of a tuned amplifier are tuned-circuit impedance and tuned-circuit Q. Since the resistance of modern capacitors is low at ordinary frequencies, the resistance usually can be considered to be concentrated in the coil. The resistance to be considered in making Q determinations is the r-f resistance, not the d-c resistance of the wire in the coil. The latter ordinarily is low enough that it may be neglected. The increase in r-f resistance over d-c resistance primarily is due to skin effect and is influenced by such factors as wire size and type, and the proximity of metallic objects or poor insulators, such as coil forms with high losses. Higher values of Q lead to better selectivity and increased r-f voltage across the tuned circuit. The increase in voltage is due to an increase in the circuit impedance with the higher values of Q.

Frequently it is possible to secure an increase in impedance in a resonant circuit, and consequently an increase in gain from an amplifier stage, by increasing the reactance through the use of larger coils and smaller tuning capacitors (higher L/C ratio).

Input Resistance Another factor which influences the operation of tuned circuits is the input resistance of the tubes placed across these circuits. At broadcast frequencies, the input resistance of most conventional r-f amplifier tubes is high enough so that it is not bothersome. But as the frequency is increased, the input resistance becomes lower and lower, until it ultimately reaches a value so low that no amplification can be obtained from the r-f stage.

The two contributing factors to the decrease in input resistance with increasing frequency are the transit time required by an electron traveling between the cathode and grid, and the inductance of the cathode lead common to both the plate and grid circuits. As the frequency becomes higher, the transit time can become an appreciable portion of the time required by an r-f cycle of the signal voltage, and current will actually flow into the grid. The result of this effect is similar to that which would be obtained by placing a resistance between the tube's grid and cathode.

Superheterodyne Tracking Because the oscillator in a superheterodyne operates "offset" from the other front end circuits, it is necessary to make special provisions to allow the oscillator to track when similar tuning capacitor sections are

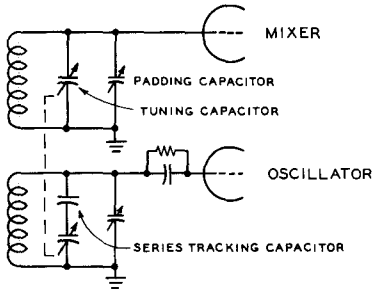

Figure 12
SERIES TRACKING EMPLOYED
IN THE H-F OSCILLATOR OF A
SUPERHETERODYNE

The series tracking capacitor permits the use of identical gangs in a ganged capacitor, since the tracking capacitor slows down the rate of frequency change in the oscillator so that a constant difference in frequency between the oscillator and the r-f stage (equal to the i-f amplifier frequency) may be maintained.

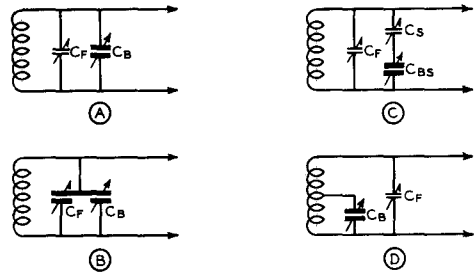

Figure 13
BANDSPREAD CIRCUITS
Parallel bandspread is illustrated at (A) and (B), series bandspread at (C), and tapped-coil bandspread at (D).

ganged. The usual method of obtaining good tracking is to operate the oscillator on the high-frequency side of the mixer and use a series tracking capacitor to slow down the tuning rate of the oscillator. The oscillator tuning rate must be slower because it covers a smaller range than does the mixer when both are expressed as a percentage of frequency. At frequencies above 7000 kc. and with ordinary intermediate frequencies, the difference in percentage between the two tuning ranges is so small that it may be disregarded in receivers designed to cover only a small range, such as an amateur band.

A mixer and oscillator tuning arrangement in which a series tracking capacitor is provided is shown in figure 12. The value of the tracking capacitor varies considerably with different intermediate frequencies and tuning ranges, capacitances as low as .0001 μ fd. being used at the lower tuning-range frequencies, and values up to .01 μ fd. being used at the higher frequencies.

Superheterodyne receivers designed to cover only a single frequency range, such as the standard broadcast band, sometimes obtain tracking between the oscillator and the r-f circuits by cutting the variable plates of the oscillator tuning section to a different shape from those used to tune the r-f stages.

Frequency Range Selection The frequency to which a receiver responds may be varied by changing the size of either the coils or the capacitors in the tuning circuits, or both. In short-wave receivers

a combination of both methods is usually employed, the coils being changed from one band to another, and variable capacitors being used to tune the receiver across each band. In practical receivers, coils may be changed by one of two methods: a switch, controllable from the panel, may be used to switch coils of different sizes into the tuning circuits or, alternatively, coils of different sizes may be plugged manually into the receiver, the connection into the tuning circuits being made by suitable plugs on the coils. Where there are several *plug-in coils* for each band, they are sometimes arranged to a single mounting strip, allowing them all to be plugged in simultaneously.

Bandspread Tuning In receivers using large tuning capacitors to cover the short-wave spectrum with a minimum of coils, tuning is likely to be quite difficult, owing to the large frequency range covered by a small rotation of the variable capacitors. To alleviate this condition, some method of slowing down the tuning rate, or *bandspreading*, must be used.

Quantitatively, bandspread is usually designated as being inversely proportional to the range covered. Thus, a large amount of bandspread indicates that a small frequency range is covered by the bandspread control. Conversely, a small amount of bandspread is taken to mean that a large frequency range is covered by the bandspread dial.

Types of Bandspread Bandspreading systems are of two general types: electrical and mechanical. Mechanical systems are exemplified by high-ratio dials in which the tuning capacitors rotate much more slowly

than the dial knob. In this system, there is often a separate scale or pointer either connected or geared to the dial knob to facilitate accurate dial readings. However, there is a practical limit to the amount of mechanical bandspread which can be obtained in a dial and capacitor before the speed-reduction unit and capacitor bearings become prohibitively expensive. Hence, most receivers employ a combination of electrical and mechanical bandspread. In such a system, a moderate reduction in the tuning rate is obtained in the dial, and the rest of the reduction obtained by *electrical bandspreading*.

Stray Circuit Capacitance In this book and in other radio literature, mention is sometimes made of *stray or circuit capacitance*. This capacitance is in the usual sense defined as the capacitance remaining across a coil when all the tuning, bandspread, and padding capacitors across the circuit are at their minimum capacitance setting.

Circuit capacitance can be attributed to two general sources. One source is that due to the input and output capacitance of the tube when its cathode is heated. The input capacitance varies somewhat from the static value when the tube is in actual operation. Such factors as plate load impedance, grid bias, and frequency will cause a change in input capacitance. However, in all except the extremely high-transconductance tubes, the published measured input capacitance is reasonably close to the effective value when the tube is used within its recommended frequency range. But in the high-transconductance types the effective capacitance will vary considerably from the published figures as operating conditions are changed.

The second source of circuit capacitance, and that which is more easily controllable, is that contributed by the minimum capacitance of the variable capacitors across the circuit and that due to capacitance between the wiring and ground. In well-designed high-frequency receivers, every effort is made to keep this portion of the circuit capacitance at a minimum since a large capacitance reduces the tuning range available with a given coil and prevents a good L/C ratio, and consequently a high-impedance tuned circuit, from being obtained.

A good percentage of stray circuit capacitance is due also to distributed capacitance of the coil and capacitance between wiring points and chassis.

Typical values of circuit capacitance may run from 10 to 75 μfd . in high-frequency receivers, the first figure representing concentric-line receivers with acorn or miniature tubes and extremely small tuning capacitors,

and the latter representing all-wave sets with bandswitching, large tuning capacitors, and conventional tubes.

12-7 I-F Tuned Circuits

I-f amplifiers usually employ bandpass circuits of some sort. A bandpass circuit is exactly what the name implies—a circuit for passing a band of frequencies. Bandpass arrangements can be designed for almost any degree of selectivity, the type used in any particular case depending upon the ultimate application of the amplifier.

I-F Transformers Intermediate frequency transformers ordinarily consist of two or more tuned circuits and some method of coupling the tuned circuits together. Some representative arrangements are shown in figure 14. The circuit shown at A is the conventional i-f transformer, with the coupling, M, between the tuned circuits being provided by inductive coupling from one coil to the other. As the coupling is increased, the selectivity curve becomes less peaked, and when a condition known as *critical coupling* is reached, the top of the curve begins to flatten out. When the coupling is increased still more, a dip occurs in the top of the curve.

The windings for this type of i-f transformer, as well as most others, nearly always consist of small, flat universal-wound pies mounted either on a piece of dowel to provide an air core or on powdered-iron for *iron core* i-f transformers. The iron-core transformers generally have somewhat more gain and better selectivity than equivalent air-core units.

The circuits shown at figure 14-B and C are quite similar. Their only difference is the type of mutual coupling used, an inductance being used at B and a capacitance at C. The operation of both circuits is similar. Three resonant circuits are formed by the components. In B, for example, one resonant circuit is formed by L_1 , C_1 , C_2 and L_2 all in series. The frequency of this resonant circuit is just the same as that of a single one of the coils and capacitors, since the coils and capacitors are similar in both sides of the circuit, and the resonant frequency of the two capacitors and the two coils all in series is the same as that of a single coil and capacitor. The second resonant frequency of the complete circuit is determined by the characteristics of each half of the circuit containing the mutual coupling device. In B, this second frequency will be lower than the first, since the resonant frequency of L_1 , C_1 and the inductance, M, or L_2 , C_2 and M is lower than that of a single coil and capaci-

tor, due to the inductance of M being added to the circuit.

The opposite effect takes place at figure 14-C, where the common coupling impedance is a capacitor. Thus, at C the second resonant frequency is higher than the first. In either case, however, the circuit has two resonant frequencies, resulting in a flat-topped selectivity curve. The width of the top of the curve is controlled by the reactance of the mutual coupling component. As this reactance is increased (inductance made greater, capacitance made smaller), the two resonant frequencies become further apart and the curve is broadened.

In the circuit of figure 14-D, there is inductive coupling between the center coil and each of the outer coils. The result of this arrangement is that the center coil acts as a sharply tuned coupler between the other two. A signal somewhat off the resonant frequency of the transformer will not induce as much current in the center coil as will a signal of the correct frequency. When a smaller current is induced in the center coil, it in turn transfers a still smaller current to the output coil. The effective coupling between the outer coils increases as the resonant frequency is approached, and remains nearly constant over a small range and then decreases again as the resonant band is passed.

Another very satisfactory bandpass arrangement, which gives a very straight-sided, flat-topped curve, is the negative-mutual arrangement shown at figure 14-E. Energy is transferred between the input and output circuits in this arrangement by both the negative-mutual coils, M , and the common capacitive reactance, C . The negative-mutual coils are interwound on the same form, and connected *backward*.

Transformers usually are made tunable over a small range to permit accurate alignment in the circuit in which they are employed. This is accomplished either by means of a variable capacitor across a fixed inductance, or by means of a fixed capacitor across a variable inductance. The former usually employ either a mica-compression capacitor (designated "mica tuned"), or a small air dielectric variable capacitor (designated "air tuned"). Those which use a fixed capacitor usually employ a powdered iron core on a threaded rod to vary the inductance, and are known as "permeability tuned."

Shape Factor It is obvious that to pass modulation sidebands and to allow for slight drifting of the transmitter carrier frequency and the receiver local oscillator, the i-f amplifier must pass not a single frequency but a band of frequencies. The width of this pass band, usually 5 to 8 kc. at maximum

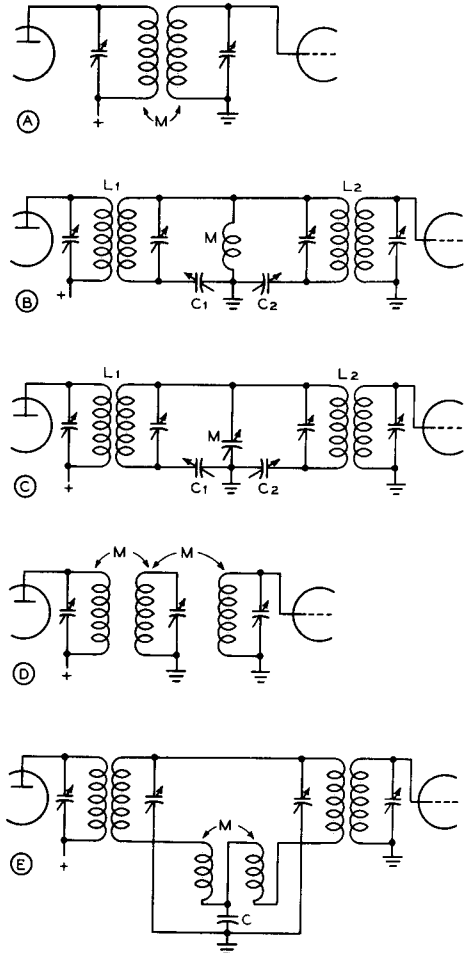

Figure 14
I-F AMPLIFIER COUPLING
ARRANGEMENTS

The interstage coupling arrangements illustrated above give a better shape factor (more straight sided selectivity curve) than would the same number of tuned circuits coupled by means of tubes.

width in a good communications receiver, is known as the *pass band*, and is arbitrarily taken as the width between the two frequencies at which the response is attenuated 6 db, or is "6 db down." However, it is apparent that to discriminate against an interfering signal which is stronger than the desired signal, much more than 6 db attenuation is required. The attenuation arbitrarily taken to indicate adequate discrimination against an interfering signal is 60 db.

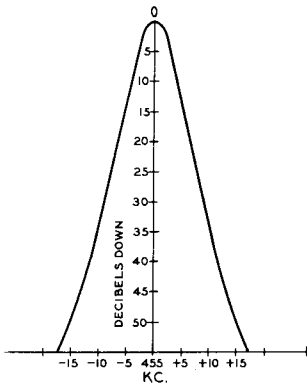

Figure 15
I-F PASS BAND OF TYPICAL
COMMUNICATIONS RECEIVER

It is apparent that it is desirable to have the bandwidth at 60 db down as narrow as possible, but it must be done without making the pass band (6 db points) too narrow for satisfactory reception of the desired signal. The figure of merit used to show the ratio of bandwidth at 6 db down to that at 60 db down is designated *shape factor*. The ideal i-f curve, a rectangle, would have a shape factor of 1.0. The i-f shape factor in typical communications receivers runs from 3.0 to 5.5.

The most practicable method of obtaining a low shape factor for a given number of tuned circuits is to employ them in pairs, as in figure 14-A, adjusted to *critical coupling* (the value at which two resonance points just begin to become apparent). If this gives too sharp a "nose" or pass band, then coils of lower Q should be employed, with the coupling maintained at the critical value. As the Q is lowered, closer coupling will be required for critical coupling.

Conversely if the pass band is too broad, coils of higher Q should be employed, the coupling being maintained at critical. If the pass band is made more narrow by using looser coupling instead of raising the Q and maintaining critical coupling, the shape factor will not be as good.

The *pass band* will not be much narrower for several pairs of identical, critically coupled tuned circuits than for a single pair. However, the *shape factor* will be greatly improved as each additional pair is added, up to about 5 pairs, beyond which the improvement for each additional pair is not significant. Commercially available communications receivers of

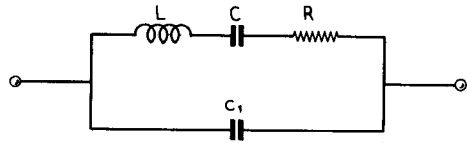

Figure 16
ELECTRICAL EQUIVALENT OF
QUARTZ FILTER CRYSTAL

The crystal is equivalent to a very large value of inductance in series with small values of capacitance and resistance, with a larger though still small value of capacitance across the whole circuit (representing holder capacitance plus stray capacitances).

good quality normally employ 3 or 4 double tuned transformers with coupling adjusted to critical or slightly less.

The pass band of a typical communication receiver having a 455 kc. i-f amplifier is shown in figure 15.

"Miller Effect" As mentioned previously, the dynamic input capacitance of a tube varies slightly with bias. As a-v-c voltage normally is applied to i-f tubes for radiotelephony reception, the effective grid-cathode capacitance varies as the signal strength varies, which produces the same effect as slight detuning of the i-f transformer. This effect is known as "Miller effect," and can be minimized to the extent that it is not troublesome either by using a fairly low L/C ratio in the transformers or by incorporating a small amount of degenerative feedback, the latter being most easily accomplished by leaving part of the cathode resistor unbypassed for r.f.

Crystal Filters The pass band of an intermediate frequency amplifier may be made very narrow through the use of a piezoelectric filter crystal employed as a series resonant circuit in a bridge arrangement known as a *crystal filter*. The shape factor is quite poor, as would be expected when the selectivity is obtained from the equivalent of a single tuned circuit, but the very narrow pass band obtainable as a result of the extremely high Q of the crystal makes the crystal filter useful for c-w telegraphy reception. The pass band of a 455 kc. crystal filter may be made as narrow as 50 cycles, while the narrowest pass band that can be obtained with a 455 kc. tuned circuit of practicable dimensions is about 5 kc.

The electrical equivalent of a filter crystal is shown in figure 16. For a given frequency, L is very high, C very low, and R (assuming

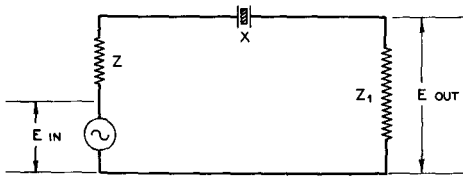

Figure 17
EQUIVALENT OF CRYSTAL
FILTER CIRCUIT

For a given voltage out of the generator, the voltage developed across Z_1 depends upon the ratio of the impedance of X to the sum of the impedances of Z and Z_1 . Because of the high Q of the crystal, its impedance changes rapidly with changes in frequency.

a good crystal of high Q) is very low. Capacitance C_1 represents the shunt capacitance of the electrodes, plus the crystal holder and wiring, and is many times the capacitance of C . This makes the crystal act as a parallel resonant circuit with a frequency only slightly higher than that of its frequency of series resonance. For crystal filter use it is the series resonant characteristic that we are primarily interested in.

The electrical equivalent of the basic crystal filter circuit is shown in figure 17. If the impedance of Z plus Z_1 is low compared to the impedance of the crystal X at resonance, then the current flowing through Z_1 , and the voltage developed across it, will be almost in inverse proportion to the impedance of X , which has a very sharp resonance curve.

If the impedance of Z plus Z_1 is made *high* compared to the resonant impedance of X , then there will be no appreciable drop in voltage across Z_1 as the frequency departs from the resonant frequency of X until the point is reached where the impedance of X approaches that of Z plus Z_1 . This has the effect of broadening out the curve of frequency versus voltage developed across Z_1 , which is another way of saying that the selectivity of the crystal filter (but not the crystal proper) has been reduced.

In practicable filter circuits the impedances Z and Z_1 usually are represented by some form of tuned circuit, but the basic principle of operation is the same.

Practical Filters It is necessary to balance out the capacitance across the crystal holder (C_1 , in figure 16) to prevent bypassing around the crystal undesired signals off the crystal resonant frequency. The balancing is done by a *phasing* circuit which takes out-of-phase voltage from a balanced in-

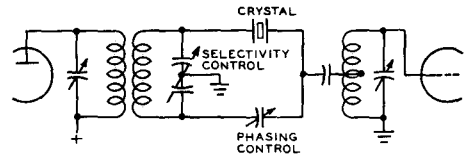

Figure 18
TYPICAL CRYSTAL FILTER CIRCUIT

put circuit and passes it to the output side of the crystal in proper phase to neutralize that passed through the holder capacitance. A representative practical filter arrangement is shown in figure 18. The balanced input circuit may be obtained either through the use of a split-stator capacitor as shown, or by the use of a center-tapped input coil.

Variable-Selectivity Filters In the circuit of figure 18, the selectivity is *minimum* with the crystal input circuit tuned to resonance, since at resonance the impedance of the tuned circuit is maximum. As the input circuit is detuned from resonance, however, the impedance decreases, and the selectivity becomes greater. In this circuit, the output from the crystal filter is tapped down on the i-f stage grid winding to provide a low value of series impedance in the output circuit. It will be recalled that for maximum selectivity, the total impedance in series with the crystal (both input and output circuits) must be low. If one is made low and the other is made variable, then the selectivity may be varied at will from sharp to broad.

The circuit shown in figure 19 also achieves variable selectivity by adding a variable impedance in series with the crystal circuit. In this case, the variable impedance is in series with the crystal output circuit. The impedance of the output circuit is varied by varying the Q . As the Q is reduced (by adding resistance in series with the coil), the impedance decreases and the selectivity becomes greater. The input circuit impedance is made low by using a non-resonant secondary on the input transformer.

A variation of the circuit shown at figure 19 consists of placing the variable resistance across the coil and capacitor, rather than in series with them. The result of adding the resistor is a reduction of the output impedance, and an increase in selectivity. The circuit behaves oppositely to that of figure 19, however; as the resistance is lowered the selectivity becomes greater. Still another variation of figure 19 is to use the tuning capacitor across the output coil to vary the output impedance.

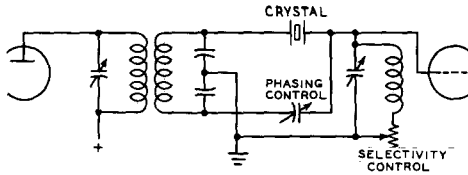

Figure 19
VARIABLE SELECTIVITY
CRYSTAL FILTER

This circuit permits of a greater control of selectivity than does the circuit of figure 16, and does not require a split-stator variable capacitor.

As the output circuit is detuned from resonance, its impedance is lowered, and the selectivity increases. Sometimes a set of fixed capacitors and a multipoint switch are used to give step-by-step variation of the output circuit tuning, and thus of the crystal filter selectivity.

Rejection Notch As previously discussed, a filter crystal has both a resonant (series resonant) and an anti-resonant (parallel resonant) frequency, the impedance of the crystal being quite low at the former frequency, and quite high at the latter frequency. The anti-resonant frequency is just slightly higher than the resonant frequency, the difference depending upon the effective shunt capacitance of the filter crystal and holder. As adjustment of the phasing capacitor controls the effective shunt capacitance of the crystal, it is possible to vary the anti-resonant frequency of the crystal slightly without unbalancing the circuit sufficiently to let undesired signals *leak through* the shunt capacitance in appreciable amplitude. At the exact anti-resonant frequency of the crystal the attenuation is exceedingly high, because of the high impedance of the crystal at this frequency. This is called the *rejection notch*, and can be utilized virtually to eliminate the heterodyne image or *repeat tuning* of c-w signals. The beat frequency oscillator can be so adjusted and the phasing capacitor so adjusted that the desired beat note is of such a pitch that the image (the same audio note on the other side of zero beat) falls in the rejection notch and is inaudible. The receiver then is said to be adjusted for *single-signal* operation.

The rejection notch sometimes can be employed to reduce interference from an undesired *phone* signal which is very close in frequency to a desired phone signal. The filter is adjusted to "broad" so as to permit tele-

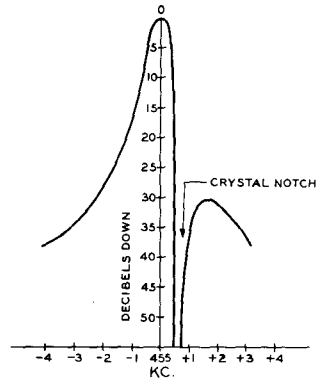

Figure 20
I-F PASS BAND OF TYPICAL
CRYSTAL FILTER
COMMUNICATIONS RECEIVER

phony reception, and the receiver tuned so that the carrier frequency of the undesired signal falls in the rejection notch. The modulation sidebands of the undesired signal still will come through, but the carrier heterodyne will be effectively eliminated and interference greatly reduced.

A typical crystal selectivity curve for a communications receiver is shown in figure 20.

Crystal Filter Considerations A crystal filter, especially when adjusted for *single signal* reception, greatly reduces interference and background noise, the latter feature permitting signals to be copied that would ordinarily be too weak to be heard above the background hiss. However, when the filter is adjusted for maximum selectivity, the pass band is so narrow that the received signal must have a high order of stability in order to stay within the pass band. Likewise, the local oscillator in the receiver must be highly stable, or constant retuning will be required. Another effect that will be noticed with the filter adjusted too "sharp" is a tendency for code characters to produce a ringing sound, and have a hangover or "tails." This effect limits the code speed that can be copied satisfactorily when the filter is adjusted for extreme selectivity.

The Mechanical Filter

The Collins Mechanical Filter (figure 21) is a new concept in the field of selectivity. It is an electro-mechanical bandpass filter about half the size of a cigarette package. As shown in figure 22, it consists of an input transducer, a resonant mechanical sec-

tion comprised of a number of metal discs, and an output transducer.

The frequency characteristics of the resonant mechanical section provide the almost rectangular selectivity curves shown in figure 23. The input and output transducers serve only as electrical to mechanical coupling devices and do not affect the selectivity characteristics which are determined by the metal discs. An electrical signal applied to the input terminals is converted into a mechanical vibration at the input transducer by means of magnetostriction. This mechanical vibration travels through the resonant mechanical section to the output transducer, where it is converted by magnetostriction to an electrical signal which appears at the output terminals.

In order to provide the most efficient electro-mechanical coupling, a small magnet in the mounting above each transducer applies a magnetic bias to the nickel transducer core. The electrical impulses then add to or subtract from this magnetic bias, causing vibration of the filter elements that corresponds to the exciting signal. There is no mechanical motion except for the imperceptible vibration of the metal discs.

Magnetostrictively-driven mechanical filters have several advantages over electrical equivalents. In the region from 100 kc. to 500 kc., the mechanical elements are extremely small, and a mechanical filter having better selectivity than the best of conventional i-f systems may be enclosed in a package smaller than one i-f transformer.

Since mechanical elements with Q's of 5000 or more are readily obtainable, mechanical filters may be designed in accordance with the theory for lossless elements. This permits filter characteristics that are unobtainable with electrical circuits because of the relatively high losses in electrical elements as compared with the mechanical elements used in the filters.

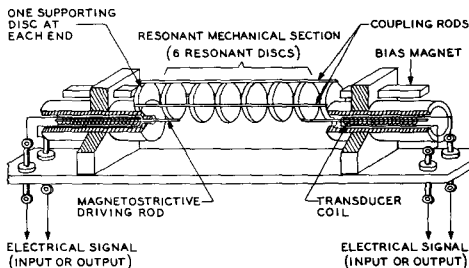

Figure 22
MECHANICAL FILTER
FUNCTIONAL DIAGRAM

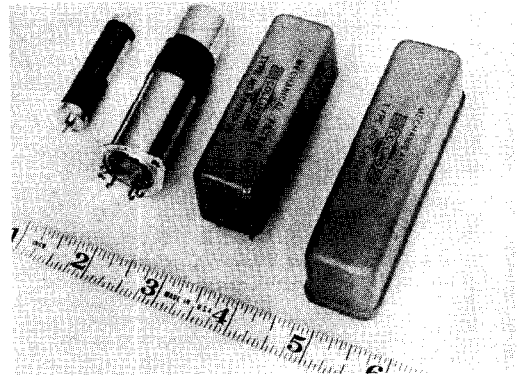

Figure 21
COLLINS MECHANICAL FILTERS

The Collins Mechanical Filter is an electro-mechanical bandpass filter which surpasses, in one small unit, the selectivity of conventional, space-consuming filters. At the left is the miniaturized filter, less than 2/4" long. Type H is next, and two horizontal mounting types are at right. For exploded view of Collins Mechanical Filter, see figure 46.

The frequency characteristics of the mechanical filter are permanent, and no adjustment is required or is possible. The filter is enclosed in a hermetically sealed case.

In order to realize full benefit from the mechanical filter's selectivity characteristics, it is necessary to provide shielding between the external input and output circuits, capable of reducing transfer of energy external to the

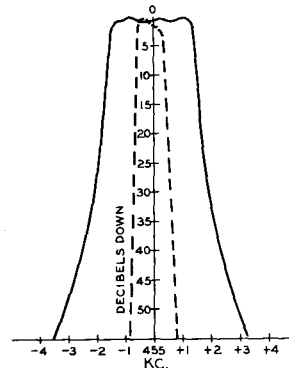

Figure 23

Selectivity curves of 455-kc. mechanical filters with nominal 0.8-kc. (dotted line) and 3.1-kc. (solid line) bandwidth at -6 db.

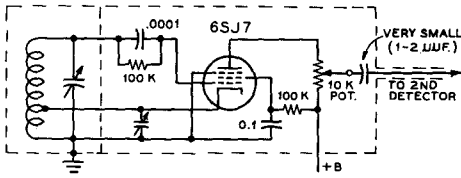

Figure 24
VARIABLE-OUTPUT B-F-O CIRCUIT
 A beat-frequency oscillator whose output is controllable is of considerable assistance in copying c-w signals over a wide range of levels, and such a control is almost a necessity for satisfactory copying of single-sideband radiophone signals.

filter by a minimum value of 100 db. If the input circuit is allowed to couple energy into the output circuit external to the filter, the excellent skirt selectivity will deteriorate and the passband characteristics will be distorted.

As with almost any mechanically resonant circuit, elements of the mechanical filter have multiple resonances. These result in spurious modes of transmission through the filter and produce minor passbands at frequencies on other sides of the primary passband. Design of the filter reduces these sub-bands to a low level and removes them from the immediate area of the major passband. Two conventional i-f transformers supply increased attenuation to these spurious responses, and are sufficient to reduce them to an insignificant level.

Beat-Frequency Oscillators The beat-frequency oscillator, usually called the *b.f.o.*, is a necessary adjunct for reception

of c-w telegraph signals on superheterodynes which have no other provision for obtaining modulation of an incoming c-w telegraphy signal. The oscillator is coupled into or just ahead of second detector circuit and supplies a signal of nearly the same frequency as that of the desired signal from the i-f amplifier. If the i-f amplifier is tuned to 455 kc., for example, the b.f.o. is tuned to approximately 454 or 456 kc. to produce an audible (1000 cycle) beat note in the output of the second detector of the receiver. The carrier signal itself is, of course, inaudible. The b.f.o. is not used for voice reception, except as an aid in searching for weak stations.

The b-f-o input to the second detector need only be sufficient to give a good beat note on an average signal. Too much coupling into the second detector will give an excessively high hiss level, masking weak signals by the high noise background.

Figure 24 shows a method of manually ad-

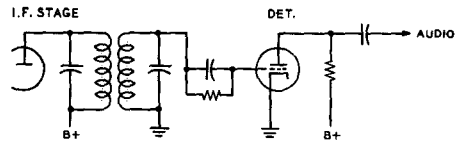

(A) GRID LEAK DETECTOR

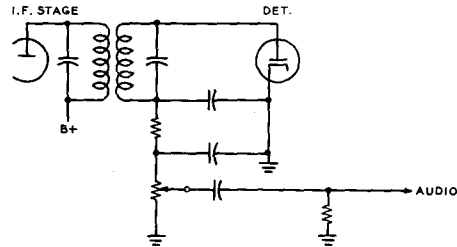

(B) DIODE DETECTOR

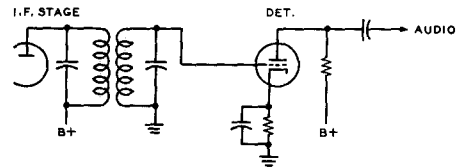

(C) PLATE DETECTOR

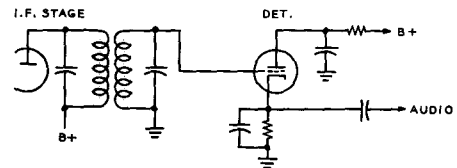

(D) INFINITE IMPEDANCE DETECTOR

Figure 25
TYPICAL CIRCUITS FOR GRID-LEAK, DIODE, PLATE AND INFINITE IMPEDANCE DETECTOR STAGES

justing the b-f-o output to correspond with the strength of received signals. This type of variable b-f-o output control is a useful adjunct to any superheterodyne, since it allows sufficient b-f-o output to be obtained to *beat* with strong signals or to allow single-sideband reception and at the same time permits the b-f-o output, and consequently the hiss, to be reduced when attempting to receive weak signals. The circuit shown is somewhat better than those in which one of the electrode volt-

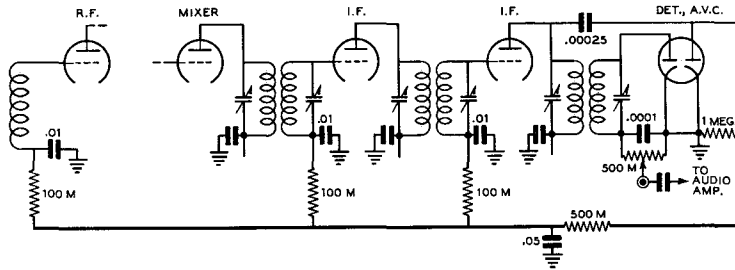

Figure 26
TYPICAL A-V-C CIRCUIT USING A DOUBLE DIODE

Any of the small dual-diode tubes may be used in this circuit. Or, if desired, a duo-diode-triode may be used, with the triode acting as the first audio stage. The left-hand diode serves as the detector, while the right-hand side acts as the a-v-c rectifier. The use of separate diodes for detector and a-v-c reduces distortion when receiving an AM signal with a high modulation percentage.

ages on the b-f-o tube is changed, as the latter circuits usually change the frequency of the b.f.o. at the same time they change the strength, making it necessary to reset the trimmer each time the output is adjusted.

The b.f.o. usually is provided with a small trimmer which is adjustable from the front panel to permit adjustment over a range of 5 or 10 kc. For single-signal reception the b.f.o. always is adjusted to the high-frequency side, in order to permit placing the heterodyne image in the rejection notch.

In order to reduce the b-f-o signal output voltage to a reasonable level which will prevent blocking the second detector, the signal voltage is delivered through a low-capacitance (high-reactance) capacitor having a value of 1 to 2 μfd .

Care must be taken with the b.f.o. to prevent harmonics of the oscillator from being picked up at multiples of the b-f-o frequency. The complete b.f.o. together with the coupling circuits to the second detector, should be thoroughly shielded to prevent pickup of the harmonics by the input end of the receiver.

If b-f-o harmonics still have a tendency to give trouble after complete shielding and isolation of the b-f-o circuit has been accomplished, the passage of these harmonics from the b-f-o circuit to the rest of the receiver can be stopped through the use of a low-pass filter in the lead between the output of the b-f-o circuit and the point on the receiver where the b-f-o signal is to be injected.

12-8 Detector, Audio, and Control Circuits

Detectors Second detectors for use in super-heterodynes are usually of the

diode, plate, or infinite-impedance types. Occasionally, grid-leak detectors are used in receivers using one i-f stage or none at all, in which case the second detector usually is made regenerative.

Diodes are the most popular second detectors because they allow a simple method of obtaining automatic volume control to be used. Diodes load the tuned circuit to which they are connected, however, and thus reduce the selectivity slightly. Special i-f transformers are used for the purpose of providing a low-impedance input circuit to the diode detector.

Typical circuits for grid-leak, diode, plate and infinite-impedance detectors are shown in figure 25.

Automatic Volume Control The elements of an automatic volume control (a.v.c.) system are shown in figure 26.

A dual-diode tube is used as a combination diode detector and a-v-c rectifier. The left-hand diode operates as a simple rectifier in the manner described earlier in this chapter. Audio voltage, superimposed on a d-c voltage, appears across the 500,000-ohm potentiometer (the volume control) and the .0001- μfd . capacitor, and is passed on to the audio amplifier. The right-hand diode receives signal voltage directly from the primary of the last i-f amplifier, and acts as the a-v-c rectifier. The pulsating d-c voltage across the 1-megohm a.v.c.-diode load resistor is filtered by a 500,000-ohm resistor and a .05- μfd . capacitor, and applied as bias to the grids of the r-f and i-f amplifier tubes; an increase or decrease in signal strength will cause a corresponding increase or decrease in a-v-c bias voltage, and thus the gain of the receiver is automatically adjusted to compensate for changes in signal strength.

A.C. Loading of Second Detector By disassociating the a.v.c. and detecting functions through using separate diodes, as shown, most of the ill effects of *a-c shunt loading* on the detector diode are avoided. This type of loading causes serious distortion, and the additional components required to eliminate it are well worth their cost. Even with the circuit shown, a-c loading can occur unless a *very high* (5 megohms, or more) value of grid resistor is used in the following audio amplifier stage.

A.V.C. in B.F.O.-Equipped Receivers In receivers having a beat frequency oscillator for the reception of radiotelegraph signals, the use of a.v.c.

can result in a great loss in sensitivity when the b.f.o. is switched on. This is because the beat oscillator output acts exactly like a strong received signal, and causes the a-v-c circuit to put high bias on the r-f and i-f stages, thus greatly reducing the receiver's sensitivity. Due to the above effect, it is necessary to provide a method of making the a-v-c circuit inoperative when the b.f.o. is being used. The simplest method of eliminating the a-v-c action is to short the a-v-c line to ground when the b.f.o. is turned on. A two-circuit switch may be used for the dual purpose of turning on the beat oscillator and shorting out the a.v.c. if desired.

Signal Strength Indicators Visual means for determining whether or not the receiver is properly tuned, as well as an indication of the relative signal strength, are both provided by means of *tuning indicators* (S meters) of the meter or vacuum-tube type.

A d-c milliammeter can be connected in the plate supply circuit of one or more r-f or i-f amplifiers, as shown in figure 27A, so that the change in plate current, due to the action of the a-v-c voltage, will be indicated on the instrument. The d-c instrument MA should have a full-scale reading approximately equal to the total plate current taken by the stage or stages whose plate current passes through the instrument. The value of this current can be estimated by assuming a plate current on each stage (with no signal input to the receiver) of about 6 ma. However, it will be found to be more satisfactory to measure the actual plate current on the stages with a milliammeter of perhaps 0-100 ma. full scale before purchasing an instrument for use as an S meter. The 50-ohm potentiometer shown in the drawing is used to adjust the meter reading to full scale with no signal input to the receiver.

When an ordinary meter is used in the plate circuit of a stage, for the purpose of indicating signal strength, the meter reads backwards

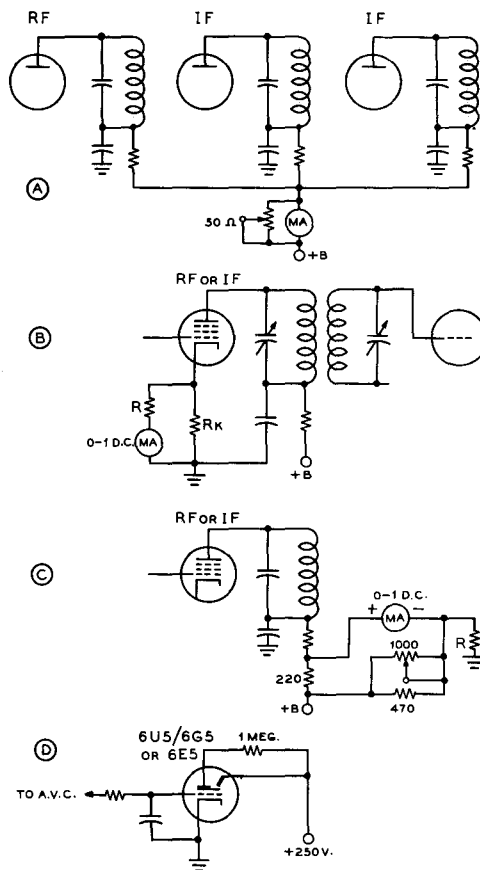

Figure 27
SIGNAL-STRENGTH-METER CIRCUITS

Shown above are four circuits for obtaining a signal-strength reading which is a function of incoming carrier amplitude. The circuits are discussed in the accompanying text.

with respect to strength. This is because increased a-v-c bias on stronger signals causes lower plate current through the meter. For this reason, special meters which indicate zero at the right-hand end of the scale are often used for signal strength indicators in commercial receivers using this type of circuit. Alternatively, the meter may be mounted upside down, so that the needle moves toward the right with increased strength.

The circuit of figure 27B can frequently be used to advantage in a receiver where the cathode of one of the r-f or i-f amplifier stages runs directly to ground through the cathode bias resistor instead of running through a cath-

ode-voltage gain control. In this case a 0-1 d-c milliammeter in conjunction with a resistor from 1000 to 3000 ohms can be used as shown as a signal-strength meter. With this circuit the meter will read backwards with increasing signal strength as in the circuit previously discussed.

Figure 27C is the circuit of a forward-reading S meter as is often used in communications receivers. The instrument is used in an unbalanced bridge circuit with the d-c plate resistance of one i-f tube as one leg of the bridge and with resistors for the other three legs. The value of the resistor R must be determined by trial and error and will be somewhere in the vicinity of 50,000 ohms. Sometimes the screen circuits of the r-f and i-f stages are taken from this point along with the screen-circuit voltage divider.

Electron-ray tubes (sometimes called "magic eyes") can also be used as indicators of relative signal strength in a circuit similar to that shown in figure 27D. A 6U5/6G5 tube should be used where the a-v-c voltage will be from 5 to 20 volts and a type 6E5 tube should be used when the a-v-c voltage will run from 2 to 8 volts.

Audio Amplifiers Audio amplifiers are employed in nearly all radio receivers. The audio amplifier stage or stages are usually of the Class A type, although Class AB push-pull stages are used in some receivers. The purpose of the audio amplifier is to bring the relatively weak signal from the detector up to a strength sufficient to operate a pair of headphones or a loud speaker. Either triodes, pentodes, or beam tetrodes may be used, the pentodes and beam tetrodes usually giving greater output. In some receivers, particularly those employing grid leak detection, it is possible to operate the headphones directly from the detector, without audio amplification. In such receivers, a single audio stage with a beam tetrode or pentode tube is ordinarily used to drive the loud speaker.

Most communications receivers, either home-constructed or factory-made, have a single-ended beam tetrode (such as a 6L6 or 6V6) or pentode (6F6 or 6K6-GT) in the audio output stage feeding the loudspeaker. If precautions are not taken such a stage will actually bring about a decrease in the effective signal-to-noise ratio of the receiver due to the rising high-frequency characteristic of such a stage when feeding a loud-speaker. One way of improving this condition is to place a mica or paper capacitor of approximately 0.003 μ fd. capacitance across the primary of the output transformer. The use of a capacitor in this manner tends to make the load impedance seen by the plate of the output tube more constant

over the audio-frequency range. The speaker and transformer will tend to present a rising impedance to the tube as the frequency increases, and the parallel capacitor will tend to make the total impedance more constant since it will tend to present a decreasing impedance with increasing audio frequency.

A still better way of improving the frequency characteristic of the output stage, and at the same time reducing the harmonic distortion, is to use shunt feedback from the plate of the output tube to the plate of a tube such as a 6SJ7 acting as an audio amplifier stage ahead of the output stage.

12-9 Noise Suppression

The problem of noise suppression confronts the listener who is located in places where interference from power lines, electrical appliances, and automobile ignition systems is troublesome. This noise is often of such intensity as to swamp out signals from desired stations.

There are two principal methods for reducing this noise:

- (1) A-c line filters at the source of interference, if the noise is created by an electrical appliance.
- (2) Noise-limiting circuits for the reduction, in the receiver itself, of interference of the type caused by automobile ignition systems.

Power Line Filters Many household appliances, such as electric mixers, heating pads, vacuum sweepers, refrigerators, oil burners, sewing machines, doorbells, etc., create an interference of an intermittent nature. The insertion of a line filter near the source of interference often will effect a complete cure. Filters for small appliances can consist of a 0.1- μ fd. capacitor connected across the 110-volt a-c line. Two capacitors in series across the line, with the midpoint connected to ground, can be used in conjunction with ultraviolet ray machines, refrigerators, oil burner furnaces, and other more stubborn offenders. In severe cases of interference, additional filters in the form of heavy-duty r-f choke coils must be connected in series with the 110-volt a-c line on both sides of the line right at the interfering appliance.

Peak Noise Limiters Numerous noise-limiting circuits which are beneficial in overcoming key clicks, automobile ignition interference, and similar noise impulses have become popular. They operate on the principle that each individual noise pulse is

of very short duration, yet of very high amplitude. The popping or clicking type of noise from electrical ignition systems may produce a signal having a peak value ten to twenty times as great as the incoming radio signal, but an average power much less than the signal.

As the duration of this type of noise peak is short, the receiver can be made inoperative during the noise pulse without the human ear detecting the total loss of signal. Some noise limiters actually *punch a hole* in the signal, while others merely *limit* the maximum peak signal which reaches the headphones or loud-speaker.

The noise peak is of such short duration that it would not be objectionable except for the fact that it produces an over-loading effect on the receiver, which increases its time constant. A sharp voltage peak will give a kick to the diaphragm of the headphones or speaker, and the momentum or inertia keeps the diaphragm in motion until the dampening of the diaphragm stops it. This movement produces a popping sound which may completely obliterate the desired signal. If the noise pulse can be limited to a peak amplitude equal to that of the desired signal, the resulting interference is practically negligible for moderately low repetition rates, such as ignition noise.

In addition, the i-f amplifier of the receiver will also tend to lengthen the duration of the noise pulses because the relatively high-Q i-f tuned circuits will *ring* or oscillate when excited by a sharp pulse, such as produced by ignition noise. The most effective noise limiter would be placed before the high-Q i-f tuned circuits. At this point the noise pulse is the sharpest and has not been degraded by passage through the i-f transformers. In addition, the pulse is eliminated before it can produce ringing effects in the i-f chain.

The Lamb Noise Limiter An i-f noise limiter is shown in figure 28. This is an adaptation of the Lamb noise silencer circuit. The i-f signal is fed into a double grid tube, such as a 6L7, and thence into the i-f chain. A 6AB7 high gain pentode is capacity coupled to the input of the i-f system. This auxiliary tube amplifies both signal and noise that is fed to it. It has a minimum of selectivity ahead of it so that it receives the true noise pulse before it is degraded by the i-f strip. A broadly tuned i-f transformer is used to couple the noise amplifier to a 6H6 noise rectifier. The gain of the noise amplifier is controlled by a potentiometer in the cathode of the 6AB7 noise amplifier. This potentiometer controls the gain of the noise amplifier

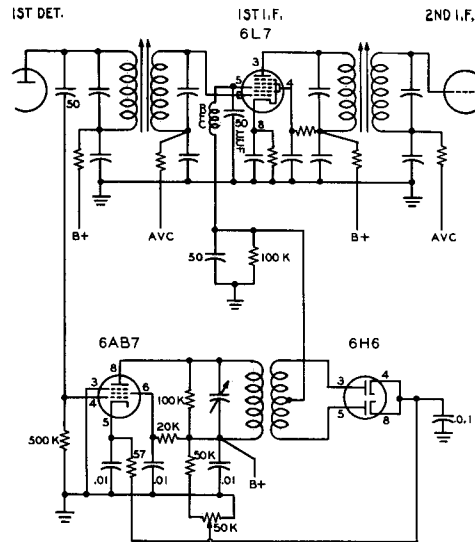

Figure 28
THE LAMB I-F NOISE SILENCER

stage and in addition sets the bias level on the 6H6 diode so that the incoming signal will not be rectified. Only noise peaks louder than the signal can overcome the resting bias of the 6H6 and cause it to conduct. A noise pulse rectified by the 6H6 is applied as a negative voltage to the control grid of the 6L7 i-f tube, disabling the tube, and punching a hole in the signal at the instant of the noise pulse. By varying the bias control of the noise limiter, the negative control voltage applied to the 6L7 may be adjusted until it is barely sufficient to overcome the noise impulses applied to the #1 control grid without allowing the modulation peaks of the carrier to become badly distorted.

The Bishop Noise Limiter Another effective i-f noise limiter is the Bishop limiter.

This is a full-wave shunt type diode limiter applied to the primary of the last i-f transformer of a receiver. The limiter is self-biased and automatically adjusts itself to the degree of modulation of the received signal. The schematic of this limiter is shown in figure 29. The bias circuit time constant is determined by C_1 and the shunt resistance, which consists of R_1 and R_2 in series. The plate resistance of the last i-f tube and the capacity of C_1 determine the charging rate of the circuit. The limiter is disabled by opening S_1 , which allows the bias to rise to the value of the i-f signal.

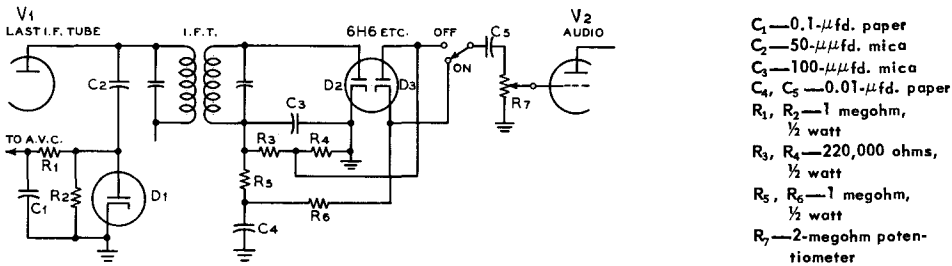

Figure 30
 NOISE LIMITER CIRCUIT, WITH ASSOCIATED A-V-C

This limiter is of the series type, and is self-adjusting to carrier strength for phone reception. For proper operation several volts should be developed across the secondary of the last i-f transformer (IFT) under carrier conditions.

If this feature is not provided, the b-f-o injection should be reduced to the lowest value that will give a satisfactory beat. When this is done, effective limiting and a good beat can be obtained by proper adjustment of the r-f and a-f gain controls. It is assumed, of course, that the a.v.c. is cut out of the circuit for c-w telegraphy reception.

Alternative Limiter Circuit The circuit of figure 31 is more effective than that shown in figure 30 under certain conditions and requires the addition of only one more resistor and one more capacitor than the other circuit. Also, this circuit involves a smaller loss in output level than the circuit of figure 30. This circuit can be used with equal effectiveness with a combined diode-triode or diode-pentode tube (6R7, 6SR7, 6Q7, 6SQ7 or similar diode-triodes, or 6B8, 6SF7, or similar diode-pentodes) as diode detector and first audio stage. However, a separate diode must be used for the noise limiter, D₂. This diode may be one-half of a 6H6, 6AL5, 7A6, etc., or it may be a triode connected 6J5, 6C4 or similar type.

Note that the return for the volume control must be made to the cathode of the detector diode (and not to ground) when a dual tube is used as combined second-detector first-audio. This means that in the circuit shown in figure 31 a connection will exist across the points where the "X" is shown on the diagram since a common cathode lead is brought out of the tube for D₁ and V₁. If desired, of course, a single dual diode may be used for D₁ and D₂ in this circuit as well as in the circuit of figure 30. Switching the limiter in and out with the switch S brings about no change in volume.

In any diode limiter circuit such as the ones shown in these two figures it is important that

the mid-point of the heater potential for the noise-limiter diode be as close to ground potential as possible. This means that the center-tap of the heater supply for the tubes should be grounded wherever possible rather than grounding one side of the heater supply as is often done. Difficulty with hum pickup in the limiter circuit *may* be encountered when one side of the heater is grounded due to the high values of resistance necessary in the limiter circuit.

The circuit of figure 31 has been used with excellent success in several home-constructed receivers, and in the BC-312/BC-342 and BC-348 series of surplus communications receivers. It is also used in certain manufactured receivers.

An excellent check on the operation of the noise limiter in any communications receiver can be obtained by listening to the Loran signals in the 160-meter band. With the limiter out a sharp rasping buzz will be obtained when one of these stations is tuned in. With the noise limiter switched into the circuit the buzz should be greatly reduced and a low-pitched hum should be heard.

The Full-Wave Limiter The most satisfactory diode noise limiter is the series full-wave limiter, shown in figure

32. The positive noise peaks are clipped by diode A, the clipping level of which may be adjusted to clip at any modulation level between 25 per cent and 100 per cent. The negative noise peaks are clipped by diode B at a fixed level.

The TNS Limiter The *Twin Noise Squelch*, popularized by CQ magazine, is a combination of a diode noise clipper and an audio squelch tube. The squelch cir-

This circuit is of the self-adjusting type and gives less distortion for a given degree of modulation than the more common limiter circuits.

- R₁, R₂—470K, ½ watt
- R₃—100K, ½ watt
- R₄, R₅—1 megohm, ½ watt
- R₆—2-megohm potentiometer
- C₁—0.00025 mica (approx.)
- C₂—0.01-μfd. paper
- C₃—0.01-μfd. paper
- C₄—0.01-μfd. paper
- D₁, D₂—6H6, 6AL5, 7A6, or diode sections of a 6S8-GT

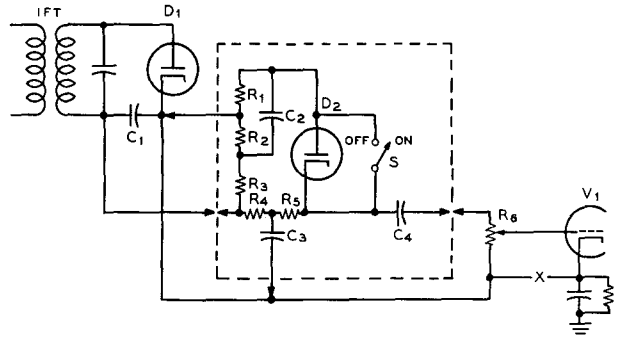

Figure 31
ALTERNATIVE NOISE LIMITER CIRCUIT

circuit is useful in eliminating the grinding background noise that is the residual left by the diode clipper. In figure 33, the setting of the 470K potentiometer determines the operating level of the squelch action and should be set to eliminate the residual background noise. Because of the low inherent distortion of the TNS, it may be left in the circuit at all times. As with other limiters, the TNS requires a high signal level at the second detector for maximum limiting effect.

wavelength sections of parallel conductors or concentric transmission line are not only more efficient but also become of practical dimensions.

Tuning Short Lines Tubes and tuning capacitors connected to the open end of a transmission line provide a capacitance that makes the resonant length less than a quarter wave-length. The amount of shortening for a specified capacitive reactance is determined by the surge impedance of the line

12-10 Special Considerations in U-H-F Receiver Design

Transmission Line Circuits At increasingly higher frequencies, it becomes progressively more difficult to obtain a satisfactory amount of selectivity and impedance from an ordinary coil and capacitor used as a resonant circuit. On the other hand, quarter

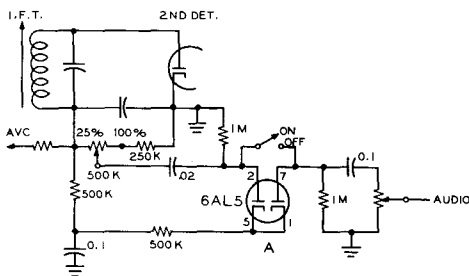

Figure 32
THE FULL-WAVE SERIES AUDIO NOISE LIMITER

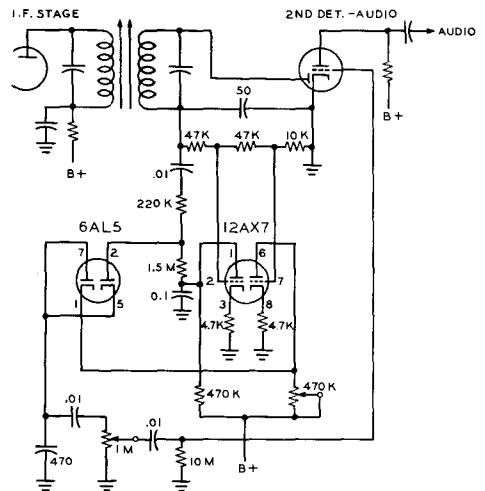

Figure 33
THE TNS AUDIO NOISE LIMITER

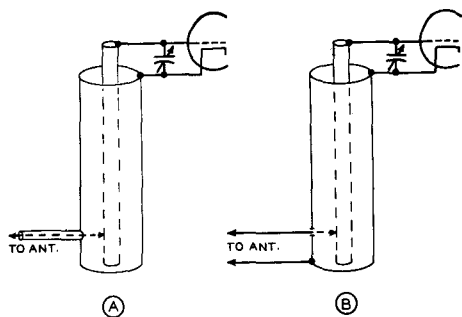

Figure 34
COUPLING AN ANTENNA TO A
COAXIAL RESONANT CIRCUIT

(A) shows the recommended method for coupling a coaxial line to a coaxial resonant circuit. (B) shows an alternative method for use with an open-wire type of antenna feed line.

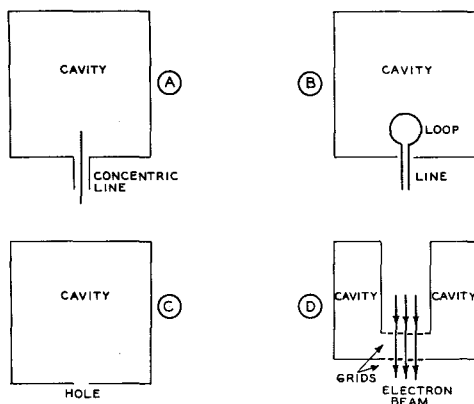

Figure 35
METHODS OF EXCITING A RESONANT
CAVITY

section. It is given by the equation for resonance:

$$\frac{1}{2\pi fC} = Z_0 \tan l$$

in which $\pi = 3.1416$, f is the frequency, C the capacitance, Z_0 the surge impedance of the line, and $\tan l$ is the tangent of the electrical length in degrees.

The capacitive reactance of the capacitance across the end is $1/(2\pi fC)$ ohms. For resonance, this must equal the surge impedance of the line times the tangent of its electrical length (in degrees, where 90° equals a quarter wave). It will be seen that twice the capacitance will resonate a line if its surge impedance is halved; also that a given capacitance has twice the loading effect when the frequency is doubled.

Coupling Into Lines and Coaxial Circuits It is possible to couple into a parallel-rod line by tapping directly on one or both rods, preferably through blocking capacitors if any d.c. is present. More commonly, however, a *hairpin* is inductively coupled at the shorting bar end, either to the bar or to the two rods, or both. This normally will result in a balanced load. Should a loop unbalanced to ground be coupled in, any resulting unbalance reflected into the rods can be reduced with a simple Faraday screen, made of a few parallel wires placed between the hairpin loop and the rods. These should be soldered at only one end and grounded.

An unbalanced tap on a coaxial resonant

circuit can be made directly on the inner conductor at the point where it is properly matched (figure 34). For low impedances, such as a concentric line feeder, a small one-half turn loop can be inserted through a hole in the outer conductor of the coaxial circuit, being in effect a half of the hairpin type recommended for coupling balanced feeders to coaxial resonant lines. The size of the loop and closeness to the inner conductor determines the impedance matching and loading. Such loops coupled in near the shorting disc do not alter the tuning appreciably, if not overcoupled.

Resonant Cavities A *cavity* is a closed resonant chamber made of metal. It is known also as a *rhumbatron*. The cavity, having both inductance and capacitance, supersedes coil-capacitor and capacitance-loaded transmission-line tuned circuits at extremely high frequencies where conventional L and C components, of even the most refined design, prove impractical because of the tiny electrical and physical dimensions they must have. Microwave cavities have high Q factors and are superior to conventional tuned circuits. They may be employed in the manner of an absorption wavemeter or as the tuned circuit in other r-f test instruments, and in microwave transmitters and receivers.

Resonant cavities usually are closed on all sides and all of their walls are made of electrical conductor. However, in some forms, small openings are present for the purpose of excitation. Cavities have been produced in several shapes including the plain sphere,

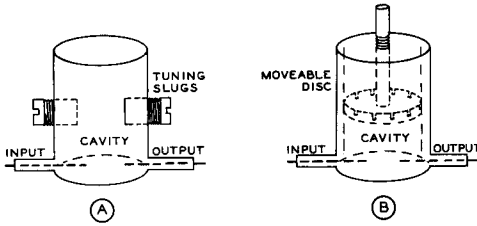

Figure 36
TUNING METHODS FOR CYLINDRICAL
RESONANT CAVITIES

dimpled sphere, sphere with reentrant cones of various sorts, cylinder, prism (including cube), ellipsoid, ellipsoid-hyperboloid, doughnut-shape, and various reentrant types. In appearance, they resemble in their simpler forms metal boxes or cans.

The cavity actually is a linear circuit, but one which is superior to a conventional coaxial resonator in the s-h-f range. The cavity resonates in much the same manner as does a barrel or a closed room with reflecting walls.

Because electromagnetic energy, and the associated electrostatic energy, oscillates to and fro inside them in one mode or another, resonant cavities resemble wave guides. The mode of operation in a cavity is affected by the manner in which micro-wave energy is injected. A cavity will resonate to a large number of frequencies, each being associated with a particular mode or standing-wave pattern. The lowest mode (lowest frequency of operation) of a cavity resonator normally is the one used.

The resonant frequency of a cavity may be varied, if desired, by means of movable plungers or plugs, as shown in figure 36A, or a movable metal disc (see figure 36B). A cavity that is too small for a given wavelength will not oscillate.

The resonant frequencies of simple spherical, cylindrical, and cubical cavities may be calculated simply for one particular mode. Wavelength and cavity dimensions (in centimeters) are related by the following simple resonance formulae:

- For Cylinder $\lambda_r = 2.6 \times \text{radius}$
- " Cube $\lambda_r = 2.83 \times \text{half of 1 side}$
- " Sphere $\lambda_r = 2.28 \times \text{radius}$

Butterfly Circuit Unlike the cavity resonator, which in its conventional form is a device which can tune over a relatively narrow band, the butterfly circuit is a tunable resonator which permits coverage of a fairly

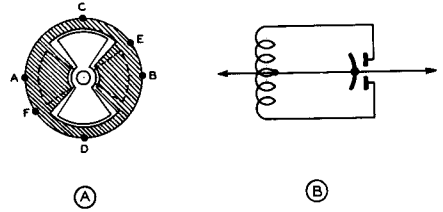

Figure 37
THE BUTTERFLY RESONANT CIRCUIT
Shown at (A) is the physical appearance of the butterfly circuit as used in the v-h-f and lower u-h-f range. (B) shows an electrical representation of the circuit.

wide u-h-f band. The butterfly circuit is very similar to a conventional coil-variable capacitor combination, except that both inductance and capacitance are provided by what appears to be a variable capacitor alone. The Q of this device is somewhat less than that of a concentric-line tuned circuit but is entirely adequate for numerous applications.

Figure 37A shows construction of a single butterfly section. The butterfly-shaped rotor, from which the device derives its name, turns in relation to the unconventional stator. The two groups of stator "fins" or sectors are in effect joined together by a semi-circular metal band, integral with the sectors, which provides the circuit inductance. When the rotor is set to fill the loop opening (the position in which it is shown in figure 37A), the circuit inductance and capacitance are reduced to minimum. When the rotor occupies the position indicated by the dotted lines, the inductance and capacitance are at maximum. The tuning range of practical butterfly circuits is in the ratio of 1.5:1 to 3.5:1.

Direct circuit connections may be made to points A and B. If balanced operation is desired, either point C or D will provide the electrical mid-point. Coupling may be effected by means of a small singleturn loop placed near point E or F. The butterfly thus permits continuous variation of both capacitance and inductance, as indicated by the equivalent circuit in figure 37B, while at the same time eliminating all pigtailed and wiping contacts.

Several butterfly sections may be stacked in parallel in the same way that variable capacitors are built up. In stacking these sections, the effect of adding inductances in parallel is to lower the total circuit inductance, while the addition of stators and rotors raises the total capacitance, as well as the ratio of maximum to minimum capacitance.

Butterfly circuits have been applied specifically to oscillators for transmitters, superheterodyne receivers, and heterodyne frequency meters in the 100-1000-Mc. frequency range.

Receiver Circuits The types of resonant circuits described in the previous paragraphs have largely replaced conventional coil-capacitor circuits in the range above 100 Mc. Tuned short lines and butterfly circuits are used in the range from about 100 Mc. to perhaps 3500 Mc., and above about 3500 Mc. resonant cavities are used almost exclusively. The resonant cavity is also quite generally employed in the 2000-Mc. to 3500-Mc. range.

In a properly designed receiver, thermal agitation in the first tuned circuit is amplified by subsequent tubes and predominates in the output. For good signal-to-set-noise ratio, therefore, one must strive for a high-gain low-noise r-f stage. Hiss can be held down by giving careful attention to this point. A mixer has about 0.3 of the gain of an r-f tube of the same type; so it is advisable to precede a mixer by an efficient r-f stage. It is also of some value to have good r-f selectivity before the first detector in order to reduce noises produced by beating noise at one frequency against noise at another, to produce noise at the intermediate frequency in a superheterodyne.

The frequency limit of a tube is reached when the shortest possible external connections are used as the tuned circuit, except for abnormal types of oscillation. Wires or sizeable components are often best considered as sections of transmission lines rather than as simple resistances, capacitances, or inductances.

So long as small triodes and pentodes will operate normally, they are generally preferred as v-h-f tubes over other receiving methods that have been devised. However, the input capacitance, input conductance, and transit time of these tubes limit the upper frequency at which they may be operated. The input resistance, which drops to a low value at very short wave-lengths, limits the stage gain and broadens the tuning.

V-H-F Tubes The first tube in a v-h-f receiver is most important in raising the signal above the noise generated in successive stages, for which reason small v-h-f types are definitely preferred.

Tubes employing the conventional grid-controlled and diode rectifier principles have been modernized, through various expedients, for operation at frequencies as high, in some new types, as 4000 Mc. Beyond that frequency, electron transit time becomes the limiting fac-

tor and new principles must be enlisted. In general, the improvements embodied in existing tubes have consisted of (1) reducing electrode spacing to cut down electron transit time, (2) reducing electrode areas to decrease interelectrode capacitances, and (3) shortening of electrode leads either by mounting the electrode assembly close to the tube base or by bringing the leads out directly through the glass envelope at nearby points. Through reduction of lead inductance and interelectrode capacitances, input and output resonant frequencies due to tube construction have been increased substantially.

Tubes embracing one or more of the features just outlined include the later loctal types, high-frequency acorns, button-base types, and the lighthouse types. Type 6J4 button-base triode will reach 500 Mc. Type 6F4 acorn triode is recommended for use up to 1200 Mc. Type 1A3 button-base diode has a resonant frequency of 1000 Mc., while type 9005 acorn diode resonates at 1500 Mc. Lighthouse type 2C40 can be used at frequencies up to 3500 Mc. as an oscillator.

Crystal Rectifiers More than two decades have passed since the crystal (mineral) rectifier enjoyed widespread use in radio receivers. Low-priced tubes completely supplanted the fragile and relatively insensitive crystal detector, although it did continue for a few years as a simple meter rectifier in absorption wavemeters after its demise as a receiver component.

Today, the crystal detector is of new importance in microwave communication. It is being employed as a detector and as a mixer in receivers and test instruments used at extremely high radio frequencies. At some of the frequencies employed in microwave operations, the crystal rectifier is the only satisfactory detector or mixer. The chief advantages of the crystal rectifier are very low capacitance, relative freedom from transit-time difficulties, and its two-terminal nature. No batteries or a-c power supply are required for its operation.

The crystal detector consists essentially of a small piece of silicon or germanium mounted in a base of low-melting-point alloy and contacted by means of a thin, springy feeler wire known as the *cat whisker*. This arrangement is shown in figure 38A.

The complex physics of crystal rectification is beyond the scope of this discussion. It is sufficient to state that current flows from several hundred to several thousand times more readily in one direction through the contact of cat whisker and crystal than in the opposite direction. Consequently, an alternating current (including one of microwave frequency) will

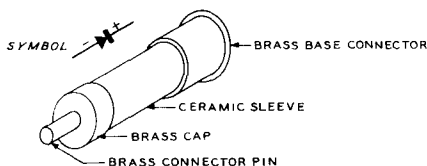

Figure 38
1N23 MICROWAVE-TYPE
CRYSTAL DIODE

A small silicon crystal is attached to the base connector and a fine "cat-whisker" wire is set to the most sensitive spot on the crystal. After adjustment the ceramic shell is filled with compound to hold the contact wire in position. Crystals of this type are used to over 30,000 mc.

be rectified by the crystal detector. The load, through which the rectified currents flow, may be connected in series or shunt with the crystal, although the former connection is most generally employed.

The basic arrangement of a modern fixed crystal detector developed during World War II for microwave work, particularly radar, is shown in figure 38B. Once the cat whisker of this unit is set at the factory to the most sensitive spot on the surface of the silicon crystal and its pressure is adjusted, a filler compound is injected through the filling hole to hold the cat whisker permanently in position.

12-11 Receiver Adjustment

A simple regenerative receiver requires little adjustment other than that necessary to insure correct tuning and smooth regeneration over some desired range. Receivers of the tuned radio-frequency type and superheterodynes require precise alignment to obtain the highest possible degree of selectivity and sensitivity.

Good results can be obtained from a receiver only when it is properly aligned and adjusted. The most practical technique for making these adjustments is given below.

Instruments A very small number of instruments will suffice to check and align a communications receiver, the most important of these testing units being a modulated oscillator and a d-c and a-c voltmeter. The meters are essential in checking the voltage applied at each circuit point from the power supply. If the a-c voltmeter is of the oxide-rectifier type, it can be used, in addition, as an output meter when connected across the

receiver output when tuning to a modulated signal. If the signal is a steady tone, such as from a test oscillator, the output meter will indicate the value of the detected signal. In this manner, alignment results may be visually noted on the meter.

T-R-F Receiver Alignment Procedure in a multistage t-r-f receiver is exactly the same as aligning a single stage. If the detector is regenerative, each preceding stage is successively aligned while keeping the detector circuit tuned to the test signal, the latter being a station signal or one locally generated by a test oscillator loosely coupled to the antenna lead. During these adjustments, the r-f amplifier gain control is adjusted for maximum sensitivity, assuming that the r-f amplifier is stable and does not oscillate. Often a sensitive receiver can be roughly aligned by tuning for maximum noise pickup.

Superheterodyne Alignment Aligning a superhet is a detailed task requiring a great amount of care and patience.

It should never be undertaken without a thorough understanding of the involved job to be done and then only when there is abundant time to devote to the operation. There are no short cuts; every circuit must be adjusted individually and accurately if the receiver is to give peak performance. The precision of each adjustment is dependent upon the accuracy with which the preceding one was made.

Superhet alignment requires (1) a good signal generator (modulated oscillator) covering the radio and intermediate frequencies and equipped with an attenuator; (2) the necessary socket wrenches, screwdrivers, or "neutralizing tools" to adjust the various i-f and r-f trimmer capacitors; and (3) some convenient type of tuning indicator, such as a copper-oxide or electronic voltmeter.

Throughout the alignment process, unless specifically stated otherwise, the r-f gain control must be set for maximum output, the beat oscillator switched off, and the a.v.c. turned off or shorted out. When the signal output of the receiver is excessive, either the attenuator or the a-f gain control may be turned down, but never the r-f gain control.

I-F Alignment After the receiver has been given a rigid electrical and mechanical inspection, and any faults which may have been found in wiring or the selection and assembly of parts corrected, the i-f amplifier may be aligned as the first step in the checking operations.

With the signal generator set to give a modulated signal on the frequency at which the i-f

amplifier is to operate, clip the "hot" output lead from the generator to the last i-f stage through a small fixed capacitor to the control grid. Adjust both trimmer capacitors in the last i-f transformer (the one between the last i-f amplifier and the second detector) to resonance as indicated by maximum deflection of the output meter.

Each i-f stage is adjusted in the same manner, moving the hot lead, stage by stage, back toward the front end of the receiver and backing off the attenuator as the signal strength increases in each new position. The last adjustment will be made to the first i-f transformer, with the hot signal generator lead connected to the control grid of the mixer. Occasionally it is necessary to disconnect the mixer grid lead from the coil, grounding it through a 1,000- or 5,000-ohm resistor, and coupling the signal generator through a small capacitor to the grid.

When the last i-f adjustment has been completed, it is good practice to go back through the i-f channel, re-peaking all of the transformers. It is imperative that this recheck be made in sets which do not include a crystal filter, and where the simple alignment of the i-f amplifier to the generator is final.

I-F with Crystal Filter There are several ways of aligning an i-f channel which contains a crystal-filter circuit.

However, the following method is one which has been found to give satisfactory results in every case: An unmodulated signal generator capable of tuning to the frequency of the filter crystal in the receiver is coupled to the grid of the stage which precedes the crystal filter in the receiver. Then, with the crystal filter switched in, the signal generator is tuned *slowly* to find the frequency where the crystal peaks. The receiver "S" meter may be used as the indicator, and the sound heard from the loudspeaker will be of assistance in finding the point. When the frequency at which the crystal peaks has been found, all the i-f transformers in the receiver should be touched up to peak at that frequency.

B-F-O Adjustment Adjusting the beat oscillator on a receiver that has no front panel adjustment is relatively simple. It is only necessary to tune the receiver to resonance with any signal, as indicated by the tuning indicator, and then turn on the b.f.o. and set its trimmer (or trimmers) to produce the desired beat note. Setting the beat oscillator in this way will result in the beat note being stronger on one "side" of the signal than on the other, which is what is desired for c-w reception. The b.f.o. should *not* be set to *zero beat* when the receiver is tuned to

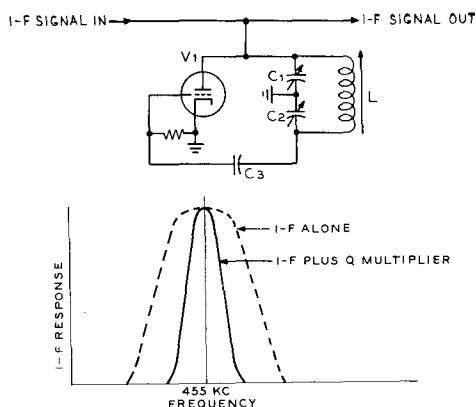

Figure 39
THE Q-MULTIPLIER

The loss resistance of a high-Q circuit is neutralized by regeneration in a simple feedback amplifier. A highly selective passband is produced which is coupled to the i-f circuit of the receiver.

resonance with the signal, as this will cause an equally strong beat to be obtained on both sides of resonance.

Front-End Alignment Alignment of the front end of a home-constructed receiver is a relatively simple process, consisting of first getting the oscillator to cover the desired frequency range and then peaking the various r-f circuits for maximum gain. However, if the frequency range covered by the receiver is very wide a fair amount of cut and try will be required to obtain satisfactory tracking between the r-f circuits and the oscillator. Manufactured communications receivers should always be tuned in accordance with the instructions given in the maintenance manual for the receiver.

12-12 Receiving Accessories

The Q-Multiplier The selectivity of a receiver may be increased by raising the Q of the tuned circuits of the i-f strip. A simple way to accomplish this is to add a controlled amount of positive feedback to a tuned circuit, thus increasing its Q. This is done in the *Q-multiplier*, whose basic circuit is shown in figure 39. The circuit L-C1-C2 is tuned to

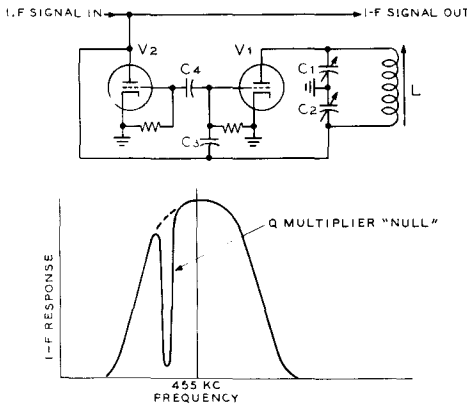

Figure 40
Q-MULTIPLIER NULL CIRCUIT

The addition of a second triode permits the Q-Multiplier to be used for nulling out an unwanted heterodyne.

the intermediate frequency, and the loss resistance of the circuit is neutralized by the positive feedback circuit composed of C3 and the vacuum tube. Too great a degree of positive feedback will cause the circuit to break into oscillation.

At the resonant frequency, the impedance of the tuned circuit is very high, and when shunted across an i-f stage will have little effect upon the signal. At frequencies removed from resonance, the impedance of the circuit is low, resulting in high attenuation of the i-f signal. The resonant frequency of the Q-multiplier may be varied by changing the value of one of the components in the tuned circuit.

The Q-multiplier may also be used to "null" a signal by employing negative feedback to control the plate resistance of an auxiliary amplifier stage as shown in figure 40. Since the grid-cathode phase shift through the Q-multiplier is zero, the plate resistance of a second tube may be readily controlled by placing it across the Q-multiplier. At resonance, the high negative feedback drops the plate resistance of V2, shunting the i-f circuit. Off resonance, the feedback is reduced and the plate resistance of V2 rises, reducing the amount of signal attenuation in the i-f strip. A circuit combining both the "peak" and "null" features is shown in figure 41.

The Product Detector

A version of the common mixer or converter stage

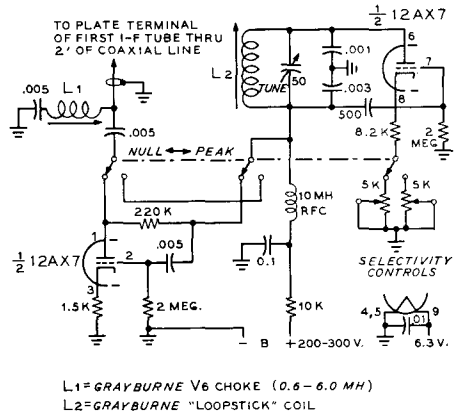

Figure 41
SCHEMATIC OF A 455KC
Q-MULTIPLIER

Coil L1 is required to tune out the reactance of the coaxial line. It is adjusted for maximum signal response. L1 may be omitted if the Q-multiplier is connected to the receiver with a short length of wire, and the i-f transformer within the receiver is retuned.

may be used as a second detector in a receiver in place of the usual diode detector. The diode is an envelope detector (section 12-1) and develops a d-c output voltage from a single rf signal, and audio "beats" from two or more input signals. A product detector (figure 42) requires that a local carrier voltage be present in order to produce an audio output signal.

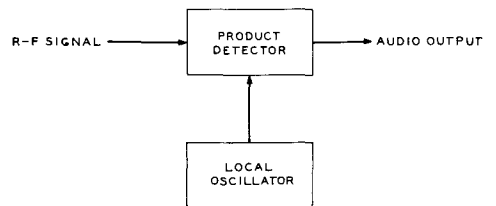

Figure 42
THE PRODUCT
DETECTOR

Audio output signal is developed only when local oscillator is on.

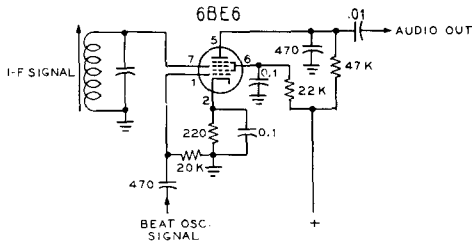

Figure 43
PENTAGRID MIXER
USED AS PRODUCT
DETECTOR

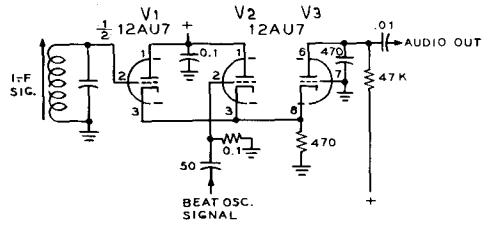

Figure 44
TRIPLE-TRIODE
PRODUCT DETECTOR

V1 and V2 act as cathode followers, delivering sideband signal and local oscillator signal to grounded grid triode mixer (V3).

Such a detector is useful for single sideband work, since the inter-modulation distortion is extremely low.

A pentagrid product detector is shown in figure 43. The incoming signal is applied to grid 3 of the mixer tube, and the local oscillator is injected on grid 1. Grid bias is adjusted for operation over the linear portion of the tube characteristic curve. When grid 1 injection is removed, the audio output from an unmodulated signal applied to grid 3 should be reduced approximately 30 to 40 db below normal detection level. When the frequency of the local oscillator is synchronized with the incoming carrier, amplitude modulated signals may be received by *exalted carrier* reception, wherein the local carrier substitutes for the transmitted carrier of the a-m signal.

Three triodes may be used as a product detector (figure 44). Triodes V1 and V2 act as cathode followers, delivering the sideband signal and the local oscillator signal to a grounded grid triode (V3) which functions as the mixer stage. A third version of the product detector is illustrated in figure 45. A twin triode tube is used. Section V1 functions as a cathode follower amplifier. Section V2 is a

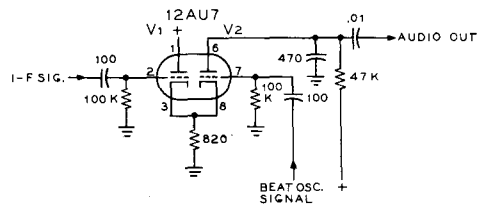

Figure 45
DOUBLE-TRIODE
PRODUCT DETECTOR

“plate” detector, the cathode of which is common with the cathode follower amplifier. The local oscillator signal is injected into the grid circuit of tube V2.

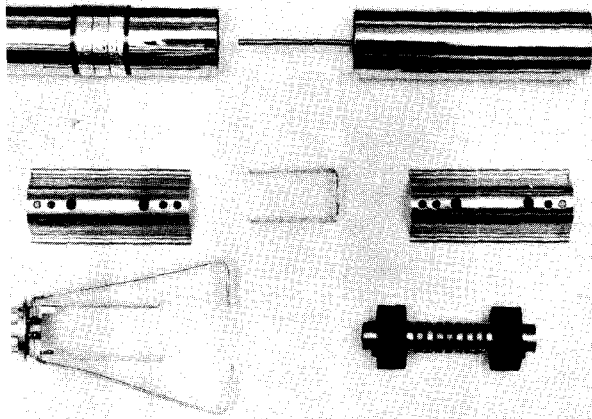

Figure 46
EXPLODED VIEW OF COLLINS
MECHANICAL FILTER

Generation of Radio Frequency Energy

A radio communication or broadcast transmitter consists of a source of radio frequency power, or *carrier*; a system for *modulating* the carrier whereby voice or telegraph keying or other modulation is superimposed upon it; and an antenna system, including feed line, for *radiating* the intelligence-carrying radio frequency power. The power supply employed to convert primary power to the various voltages required by the r-f and modulator portions of the transmitter may also be considered part of the transmitter.

Voice modulation usually is accomplished by varying either the amplitude or the frequency of the radio frequency carrier in accordance with the components of intelligence to be transmitted.

Radiotelegraph modulation (keying) normally is accomplished either by interrupting, shifting the frequency of, or superimposing an audio tone on the radio-frequency carrier in accordance with the dots and dashes to be transmitted.

The complexity of the radio-frequency generating portion of the transmitter is dependent upon the power, order of stability, and frequency desired. An oscillator feeding an antenna directly is the simplest form of radio-frequency generator. A modern high-frequency transmitter, on the other hand, is a very complex generator. Such an equipment usually comprises a very

stable crystal-controlled or self-controlled oscillator to stabilize the output frequency, a series of frequency multipliers, one or more amplifier stages to increase the power up to the level which is desired for feeding the antenna system, and a filter system for keeping the harmonic energy generated in the transmitter from being fed to the antenna system.

13-1 Self-Controlled Oscillators

In Chapter Four, it was explained that the amplifying properties of a tube having three or more elements give it the ability to generate an alternating current of a frequency determined by the components associated with it. A vacuum tube operated in such a circuit is called an *oscillator*, and its function is essentially to convert direct current into radio-frequency alternating current of a predetermined frequency.

Oscillators for controlling the frequency of conventional radio transmitters can be divided into two general classes: self-controlled and crystal-controlled.

There are a great many types of self-controlled oscillators, each of which is best suited

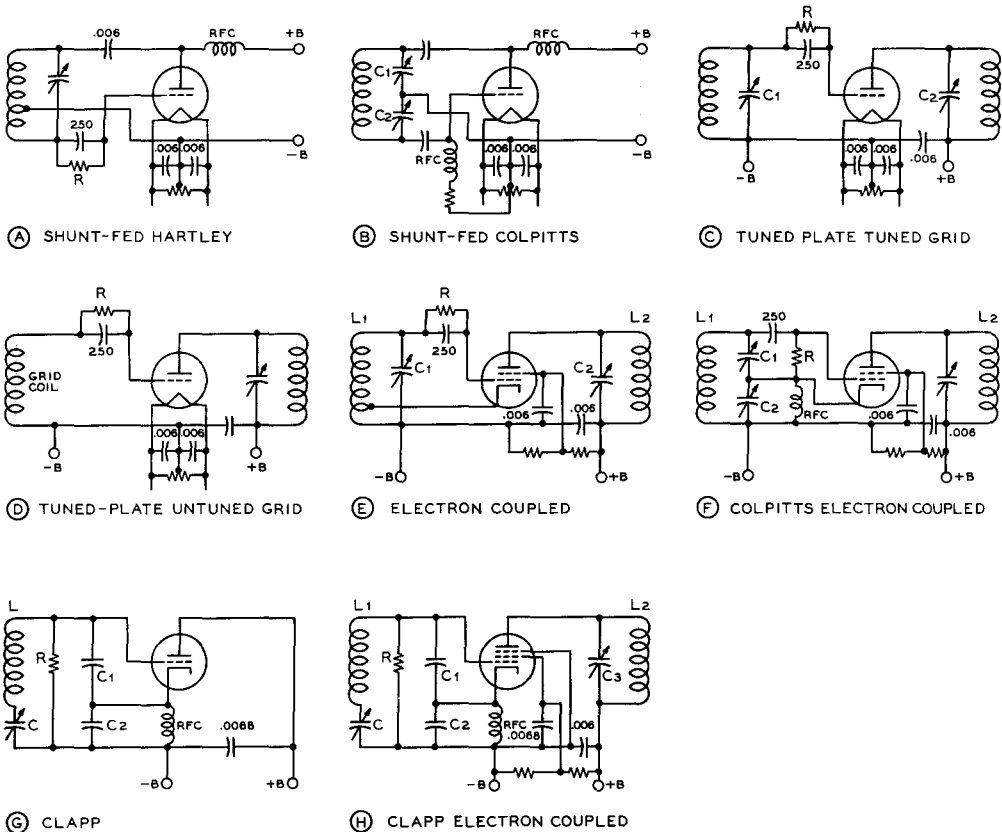

Figure 1
COMMON TYPES OF SELF-EXCITED OSCILLATORS

Fixed capacitor values are typical, but will vary somewhat with the application. In the Clapp oscillator circuits (G) and (H), capacitors C_1 and C_2 should have a reactance of 50 to 100 ohms at the operating frequency of the oscillator. Tuning of these two oscillators is accomplished by capacitor C. In the circuits of (E), (F), and (H), tuning of the tank circuit in the plate of the oscillator tube will have relatively small effect on the frequency of oscillation. The plate tank circuit also may, if desired, be tuned to a harmonic of the oscillation frequency, or a broadly resonant circuit may be used in this circuit position.

to a particular application. They can further be subdivided into the classifications of: negative-grid oscillators, electron-orbit oscillators, negative-resistance oscillators, velocity modulation oscillators, and magnetron oscillators.

Negative-Grid Oscillators A negative-grid oscillator is essentially a vacuum-tube amplifier with a sufficient portion of the output energy coupled back into the input circuit to sustain oscillation. The con-

trol grid is biased negatively with respect to the cathode. Common types of negative-grid oscillators are diagrammed in figure 1.

The Hartley Illustrated in figure 1 (A) is the oscillator circuit which finds the most general application at the present time; this circuit is commonly called the Hartley. The operation of this oscillator will be described as an index to the operation of all negative-grid oscillators; the only real differ-

ence between the various circuits is the manner in which energy for excitation is coupled from the plate to the grid circuit.

When plate voltage is applied to the Hartley oscillator shown at (A), the sudden flow of plate current accompanying the application of plate voltage will cause an electro-magnetic field to be set up in the vicinity of the coil. The building-up of this field will cause a potential drop to appear from turn-to-turn along the coil. Due to the inductive coupling between the portion of the coil in which the plate current is flowing and the grid portion, a potential will be induced in the grid portion.

Since the cathode tap is between the grid and plate ends of the coil, the induced grid voltage acts in such a manner as to increase further the plate current to the tube. This action will continue for a short period of time determined by the inductance and capacitance of the tuned circuit, until the *flywheel effect* of the tuned circuit causes this action to come to a maximum and then to reverse itself. The plate current then decreases, the magnetic field around the coil also decreasing, until a minimum is reached, when the action starts again in the original direction and at a greater amplitude than before. The amplitude of these oscillations, the frequency of which is determined by the coil-capacitor circuit, will increase in a very short period of time to a limit determined by the plate voltage of the oscillator tube.

The Colpitts Figure 1 (B) shows a version of the Colpitts oscillator. It can be seen that this is essentially the same circuit as the Hartley except that the ratio of a pair of capacitances in series determines the effective cathode tap, instead of actually using a tap on the tank coil. Also, the net capacitance of these two capacitors comprises the tank capacitance of the tuned circuit. This oscillator circuit is somewhat less susceptible to parasitic (spurious) oscillations than the Hartley.

For best operation of the Hartley and Colpitts oscillators, the voltage from grid to cathode, determined by the tap on the coil or the setting of the two capacitors, normally should be from $1/3$ to $1/5$ that appearing between plate and cathode.

The T.P.T.G. The tuned-plate tuned-grid oscillator illustrated at (C) has a tank circuit in both the plate and grid circuits. The feedback of energy from the plate to the grid circuits is accomplished by the plate-to-grid inter-electrode capacitance within the tube. The necessary phase reversal in feedback voltage is provided by tuning the grid tank capacitor to the low side of the de-

sired frequency and the plate capacitor to the high side. A broadly resonant coil may be substituted for the grid tank to form the *T.N.T.* oscillator shown at (D).

Electron-Coupled Oscillators In any of the oscillator circuits just described it is possible to take energy from the oscillator circuit by coupling an external load to the tank circuit. Since the tank circuit determines the frequency of oscillation of the tube, any variations in the conditions of the external circuit will be coupled back into the frequency determining portion of the oscillator. These variations will result in frequency instability.

The frequency determining portion of an oscillator may be coupled to the load circuit only by an electron stream, as illustrated in (E) and (F) of figure 1. When it is considered that the screen of the tube acts as the plate to the oscillator circuit, the plate merely acting as a coupler to the load, then the similarity between the cathode-grid-screen circuit of these oscillators and the cathode-grid-plate circuits of the corresponding prototype can be seen.

The electron-coupled oscillator has good stability with respect to load and voltage variation. Load variations have a relatively small effect on the frequency, since the only coupling between the oscillating circuit and the load is through the electron stream flowing through the other elements to the plate. The plate is electrostatically shielded from the oscillating portion by the bypassed screen.

The stability of the e.c.o. with respect to variations in supply voltages is explained as follows: The frequency will shift in one direction with an increase in screen voltage, while an increase in plate voltage will cause it to shift in the other direction. By a proper proportioning of the resistors that comprise the voltage divider supplying screen voltage, it is possible to make the frequency of the oscillator substantially independent of supply voltage variations.

The Clapp Oscillator A relatively new type of oscillator circuit which is capable of giving excellent frequency stability is illustrated in figure 1G. Comparison between the more standard circuits of figure 1A through 1F and the Clapp oscillator circuits of figures 1G and 1H will immediately show one marked difference: the tuned circuit which controls the operating frequency in the Clapp oscillator is *series* resonant, while in all the more standard oscillator circuits the frequency controlling circuit is parallel resonant. Also, the capacitors C_1 and C_2 are relatively large in terms of the usual values for a Colpitts oscil-

lator. In fact, the value of capacitors C_1 and C_2 will be in the vicinity of $0.001 \mu\text{fd.}$ to $0.0025 \mu\text{fd.}$ for an oscillator which is to be operated in the 1.8-Mc. band.

The Clapp oscillator operates in the following manner: at the resonant frequency of the oscillator tuned circuit (L, C) the impedance of this circuit is at minimum (since it operates in series resonance) and maximum current flows through it. Note however, that C_1 and C_2 also are included within the current path for the series resonant circuit, so that at the frequency of resonance an appreciable voltage drop appears across these capacitors. The voltage drop appearing across C_1 is applied to the grid of the oscillator tube as excitation, while the amplified output of the oscillator tube appears across C_2 as the driving power to keep the circuit in oscillation.

Capacitors C_1 and C_2 should be made as large in value as possible, while still permitting the circuit to oscillate over the full tuning range of C. The larger these capacitors are made, the smaller will be the coupling between the oscillating circuit and the tube, and consequently the better will be oscillator stability with respect to tube variations. High G_m tubes such as the 6AC7, 6AG7, and 6CB6 will permit the use of larger values of capacitance at C_1 and C_2 than will more conventional tubes such as the 6SJ7, 6V6, and such types. In general it may be said that the reactance of capacitors C_1 and C_2 should be on the order of 40 to 120 ohms at the operating frequency of the oscillator—with the lower values of reactance going with high- G_m tubes and the higher values being necessary to permit oscillation with tubes having G_m in the range of 2000 micromhos such as the 6SJ7.

It will be found that the Clapp oscillator will have a tendency to vary in power output over the frequency range of tuning capacitor C. The output will be greatest where C is at its largest setting, and will tend to fall off with C at minimum capacitance. In fact, if capacitors C_1 and C_2 have too large a value the circuit will stop oscillation near the *minimum* capacitance setting of C. Hence it will be necessary to use a slightly *smaller* value of capacitance at C_1 and C_2 (to provide an increase in the capacitive reactance at this point), or else the frequency range of the oscillator must be restricted by paralleling a fixed capacitor across C so that its effective capacitance at minimum setting will be increased to a value which will sustain oscillation.

In the triode Clapp oscillator, such as shown at figure 1G, output voltage for excitation of an amplifier, doubler, or isolation stage normally is taken from the cathode of the oscillator tube by capacitive coupling to the grid of the next tube. However, where greater iso-

lation of succeeding stages from the oscillating circuit is desired, the electron-coupled Clapp oscillator diagrammed in figure 1H may be used. Output then may be taken from the plate circuit of the tube by capacitive coupling with either a tuned circuit, as shown, or with an r-f choke or a broadly resonant circuit in the plate return. Alternatively, energy may be coupled from the output circuit L_2-C_3 by link coupling. The considerations with regard to C_1 , C_2 , and the grid tuned circuit are the same as for the triode oscillator arrangement of figure 1G.

Negative Resistance Oscillators Negative-resistance oscillators often are used when unusually high frequency stability is desired, as in a frequency meter. The *dynatron* of a few years ago and the newer *transitron* are examples of oscillator circuits which make use of the negative resistance characteristic between different elements in some multi-grid tubes.

In the dynatron, the negative resistance is a consequence of secondary emission of electrons from the plate of a tetrode tube. By a proper proportioning of the electrode voltage, an increase in screen voltage will cause a decrease in screen current, since the increased screen voltage will cause the screen to attract a larger number of the secondary electrons emitted by the plate. Since the net screen current flowing from the screen supply will be decreased by an increase in screen voltage, it is said that the screen circuit presents a negative resistance.

If any type of tuned circuit, or even a resistance-capacitance circuit, is connected in series with the screen, the arrangement will oscillate—provided, of course, that the external circuit impedance is greater than the negative resistance. A negative resistance effect similar to the dynatron is obtained in the *transitron* circuit, which uses a pentode with the suppressor coupled to the screen. The negative resistance in this case is obtained from a combination of secondary emission and inter-electrode coupling, and is considerably more stable than that obtained from uncontrolled secondary emission alone in the dynatron. A representative transitron oscillator circuit is shown in figure 2.

The chief distinction between a conventional *negative grid oscillator* and a *negative resistance oscillator* is that in the former the tank circuit must act as a phase inverter in order to permit the amplification of the tube to act as a negative resistance, while in the latter the tube acts as its own phase inverter. Thus a negative resistance oscillator requires only an untapped coil and a single capacitor

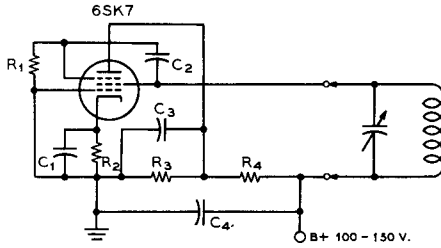

(A) TRANSATRON OSCILLATOR

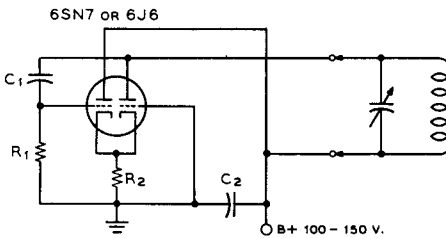

(B) CATHODE COUPLED OSCILLATOR

Figure 2
TWO-TERMINAL OSCILLATOR CIRCUITS

Both circuits may be used for an audio oscillator or for frequencies into the v-h-f range simply by placing a tank circuit tuned to the proper frequency where indicated on the drawing. Recommended values for the components are given below for both oscillators.

TRANSITION OSCILLATOR

- C₁—0.01- μ fd. mica for r.f. 10- μ fd. elect. for a.f.
- C₂—0.00005- μ fd. mica for r.f. 0.1- μ fd. paper for a.f.
- C₃—0.003- μ fd. mica for r.f. 0.5- μ fd. paper for a.f.
- C₄—0.01- μ fd. mica for r.f. 8- μ fd. elect. for a.f.
- R₁—220K ½-watt carbon
- R₂—1800 ohms ½-watt carbon
- R₃—22K 2-watt carbon
- R₄—22K 2-watt carbon

CATHODE-COUPLED OSCILLATOR

- C₁—0.00005- μ fd. mica for r.f. 0.1- μ fd. paper for audio
- C₂—0.003- μ fd. mica for r.f. 8- μ fd. elect. for audio
- R₁—47K ½-watt carbon
- R₂—1K 1-watt carbon

as the frequency determining tank circuit, and is classed as a *two terminal oscillator*. In fact, the time constant of an R/C circuit may be used as the frequency determining element and such an oscillator is rather widely used as a tunable audio frequency oscillator.

The Franklin Oscillator The Franklin oscillator makes use of two cascaded tubes to obtain the negative-resistance effect (figure 3). The tubes may be either a pair of triodes, tetrodes, or pentodes, a dual triode, or a combination of a triode and a multi-grid tube. The chief advantage of this oscillator circuit is that the frequency determining tank only has two terminals, and one side of the circuit is grounded.

The second tube acts as a phase inverter to give an effect similar to that obtained with the dynatron or transatron, except that the effective transconductance is much higher. If the tuned circuit is omitted or is replaced by a resistor, the circuit becomes a relaxation oscillator or a multivibrator.

Oscillator Stability The Clapp oscillator has proved to be inherently the most stable of all the oscillator circuits discussed above, since minimum coupling between the oscillator tube and its associated tuned circuit is possible. However, this in-

herently good stability is with respect to tube variations; instability of the tuned circuit with respect to vibration or temperature will of course have as much effect on the frequency of oscillation as with any other type of oscillator circuit. Solid mechanical construction of the components of the oscillating circuit, along with a small negative-coefficient compensating capacitor included as an element of the tuned circuit, usually will afford an adequate degree of oscillator stability.

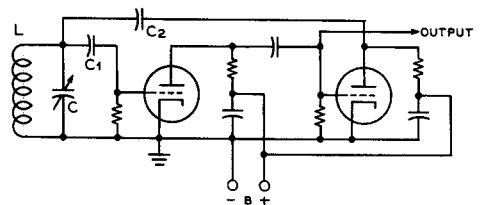

Figure 3
THE FRANKLIN OSCILLATOR CIRCUIT

A separate phase inverter tube is used in this oscillator to feed a portion of the output back to the input in the proper phase to sustain oscillation. The values of C₁ and C₂ should be as small as will permit oscillations to be sustained over the desired frequency range.

V.F.O. Transmitter Controls When used to control the frequency of a transmitter in which there are stringent limitations on frequency tolerance, several precautions are taken to ensure that a variable frequency oscillator will stay on frequency. The oscillator is fed from a voltage regulated power supply, uses a well designed and temperature compensated tank circuit, is of rugged mechanical construction to avoid the effects of shock and vibration, is protected against excessive changes in ambient room temperature, and is isolated from feedback or stray coupling from other portions of the transmitter by shielding, filtering of voltage supply leads, and incorporation of one or more buffer-amplifier stages. In a high power transmitter a small amount of stray coupling from the final amplifier to the oscillator can produce appreciable degradation of the oscillator stability if both are on the same frequency. Therefore, the oscillator usually is operated on a subharmonic of the transmitter output frequency, with one or more frequency multipliers between the oscillator and final amplifier.

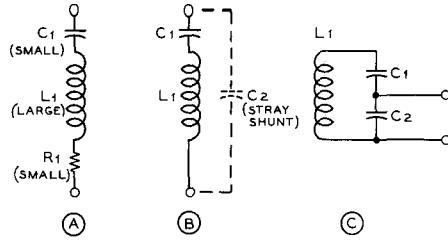

Figure 4

EQUIVALENT ELECTRICAL CIRCUIT OF QUARTZ PLATE IN A HOLDER

At (A) is shown the equivalent series-resonant circuit of the crystal itself, at (B) is shown how the shunt capacitance of the holder electrodes and associated wiring affects the circuit to the combination circuit of (C) which exhibits both series resonance and parallel resonance (anti-resonance), the separation in frequency between the two modes being very small and determined by the ratio of C_1 to C_2 .

13-2 Quartz Crystal Oscillators

Quartz is a naturally occurring crystal having a structure such that when plates are cut in certain definite relationships to the crystallographic axes, these plates will show the *piezoelectric effect*—the plates will be deformed in the influence of an electric field, and, conversely, when such a plate is compressed or deformed in any way a potential difference will appear upon its opposite sides.

The crystal has mechanical resonance, and will vibrate at a very high frequency because of its stiffness, the natural period of vibration depending upon the dimensions, the method of electrical excitation, and crystallographic orientation. Because of the piezoelectric properties, it is possible to cut a quartz plate which, when provided with suitable electrodes, will have the characteristics of a series resonant circuit with a very high L/C ratio and very high Q . The Q is several times as high as can be obtained with an inductor-capacitor combination in conventional physical sizes. The equivalent electrical circuit is shown in figure 4A, the resistance component simply being an acknowledgment of the fact that the Q , while high, does not have an infinite value.

The shunt capacitance of the electrodes and associated wiring (crystal holder and socket, plus circuit wiring) is represented by the dotted portion of figure 4B. In a high frequency

crystal this will be considerably greater than the capacitance component of an equivalent series L/C circuit, and unless the shunt capacitance is balanced out in a bridge circuit, the crystal will exhibit both resonant (series resonant) and anti-resonant (parallel resonant) frequencies, the latter being slightly higher than the series resonant frequency and approaching it as C_2 is increased.

The series resonance characteristic is employed in crystal filter circuits in receivers and also in certain oscillator circuits wherein the crystal is used as a selective feedback element in such a manner that the phase of the feedback is correct and the amplitude adequate only at or very close to the series resonant frequency of the crystal.

While quartz, tourmaline, Rochelle salts, ADP, and EDT crystals all exhibit the piezoelectric effect, quartz is the material widely employed for frequency control.

As the cutting and grinding of quartz plates has progressed to a high state of development and these plates may be purchased at prices which discourage the cutting and grinding by simple hand methods for one's own use, the procedure will be only lightly touched upon here.

The crystal blank is cut from the raw quartz at a predetermined orientation with respect to the optical and electrical axes, the orientation determining the activity, temperature coefficient, thickness coefficient, and other characteristics. Various orientations or "cuts" having useful characteristics are illustrated in figure 5.

best type mount is determined by the type crystal and its application, and usually an optimum mounting is furnished with the crystal. However, certain features are desirable in all holders. One of these is exclusion of moisture and prevention of electrode oxidization. The best means of accomplishing this is a metal holder, hermetically sealed, with glass insulation and a metal-to-glass bond. However, such holders are more expensive, and a ceramic or phenolic holder with rubber gasket will serve where requirements are not too exacting.

Temperature Control; Crystal Ovens Where the frequency tolerance requirements are not too stringent and the ambient temperature does not include extremes, an AT-cut plate, or a BT-cut plate with optimum (mean temperature) turning point, will often provide adequate stability without resorting to a temperature controlled oven. However, for broadcast stations and other applications where very close tolerances must be maintained, a thermostatically controlled oven, adjusted for a temperature slightly higher than the highest ambient likely to be encountered, must of necessity be employed.

Harmonic Cut Crystals Just as a vibrating string can be made to vibrate on its harmonics, a quartz crystal will exhibit mechanical resonance (and therefore electrical resonance) at harmonics of its fundamental frequency. When employed in the usual holder, it is possible to excite the crystal only on its odd harmonics (overtones).

By grinding the crystal especially for harmonic operation, it is possible to enhance its operation as a harmonic resonator. BT and AT cut crystals designed for optimum operation on the 3d, 5th and even the 7th harmonic are available. The 5th and 7th harmonic types, especially the latter, require special holder and oscillator circuit precautions for satisfactory operation, but the 3d harmonic type needs little more consideration than a regular fundamental type. A crystal ground for optimum operation on a particular harmonic may or may not be a good oscillator on a different harmonic or on the fundamental. One interesting characteristic of a harmonic cut crystal is that its harmonic frequency is not quite an exact multiple of its fundamental, though the disparity is very small.

The harmonic frequency for which the crystal was designed is the *working frequency*. It is not the fundamental since the crystal itself actually oscillates on this working frequency when it is functioning in the proper manner.

When a harmonic-cut crystal is employed, a selective tuned circuit must be employed somewhere in the oscillator in order to discrimi-

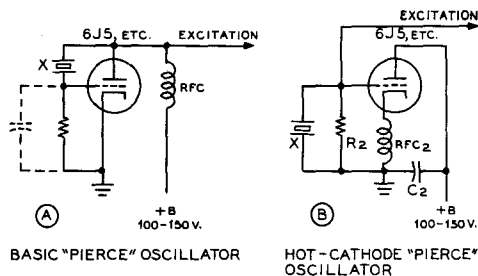

Figure 6
THE PIERCE CRYSTAL OSCILLATOR
CIRCUIT

Shown at (A) is the basic Pierce crystal oscillator circuit. A capacitance of 10 to 75 $\mu\text{fd.}$ normally will be required at C_1 for optimum operation. If a plate supply voltage higher than indicated is to be used, RFC_1 may be replaced by a 22,000-ohm 2-watt resistor. Shown at (B) is an alternative arrangement with the r-f ground moved to the plate, and with the cathode floating. This alternative circuit has the advantage that the full r-f voltage developed across the crystal may be used as excitation to the next stage, since one side of the crystal is grounded.

nate against the fundamental frequency or undesired harmonics. Otherwise the crystal might not always oscillate on the intended frequency. For this reason the Pierce oscillator, later described in this chapter, is not suitable for use with harmonic-cut crystals, because the only tuned element in this oscillator circuit is the crystal itself.

Crystal Current; Heating and Fracture For a given crystal operating as an anti-resonant tank in a given oscillator at fixed load impedance and plate and screen voltages, the r-f current through the crystal will increase as the shunt capacitance C_2 of figure 4 is increased, because this effectively increases the step-up ratio of C_1 to C_2 . For a given shunt capacitance, C_2 , the crystal current for a given crystal is directly proportional to the r-f voltage across C_2 . This voltage may be measured by means of a vacuum tube voltmeter having a low input capacitance, and such a measurement is a more pertinent one than a reading of r-f current by means of a thermogalvanometer inserted in series with one of the leads to the crystal holder.

The function of a crystal is to provide accurate frequency control, and unless it is used in such a manner as to take advantage of its inherent high stability, there is no point in using a crystal oscillator. For this reason a

crystal oscillator should not be run at high plate input in an attempt to obtain considerable power directly out of the oscillator, as such operation will cause the crystal to heat, with resultant frequency drift and possible fracture.

13-3 Crystal Oscillator Circuits

Considerable confusion exists as to nomenclature of crystal oscillator circuits, due to a tendency to name a circuit after its discoverer. Nearly all the basic crystal oscillator circuits were either first used or else developed independently by G. W. Pierce, but he has not been so credited in all the literature.

Use of the crystal oscillator in master oscillator circuits in radio transmitters dates back to about 1924 when the first application articles appeared.

The Pierce Oscillator The circuit of figure 6A is the simplest crystal oscillator circuit. It is one of those developed by Pierce, and is generally known among amateurs as the *Pierce oscillator*. The crystal simply replaces the tank circuit in a Colpitts or ultra-audion oscillator. The r-f excitation voltage available to the next stage is low, being somewhat less than that developed across the crystal. Capacitor C_1 will make more of the voltage across the crystal available for excitation, and sometimes will be found necessary to ensure oscillation. Its value is small, usually approximately equal to or slightly greater than the stray capacitance from the plate circuit to ground (including the grid of the stage being driven).

If the r-f choke has adequate inductance, a crystal (even a harmonic cut crystal) will almost invariably oscillate on its fundamental. The Pierce oscillator therefore cannot be used with harmonic cut crystals.

The circuit at (B) is the same as that of (A) except that the plate instead of the cathode is operated at ground r-f potential. All of the r-f voltage developed across the crystal is available for excitation to the next stage, but still is low for reasonable values of crystal current. For best operation a tube with low heater-cathode capacitance is required. Excitation for the next stage may also be taken from the cathode when using this circuit.

Tuned-Plate Crystal Oscillator The circuit shown in figure 7A is also one used by Pierce, but is more widely referred to as the "Miller" oscillator. To avoid

confusion, we shall refer to it as the *tuned-plate crystal oscillator*. It is essentially an Armstrong or tuned plate-tuned grid oscillator with the crystal replacing the usual L-C grid tank. The plate tank must be tuned to a frequency slightly higher than the anti-resonant (parallel resonant) frequency of the crystal. Whereas the Pierce circuits of figure 6 will oscillate at (or very close to) the anti-resonant frequency of the crystal, the circuits of figure 7 will oscillate at a frequency a little above the anti-resonant frequency of the crystal.

The diagram shown in figure 7A is the basic circuit. The most popular version of the tuned-plate oscillator employs a pentode or beam tetrode with cathode bias to prevent excessive plate dissipation when the circuit is not oscillating. The cathode resistor is optional. Its omission will reduce both crystal current and oscillator efficiency, resulting in somewhat more output for a given crystal current. The tube usually is an audio or video beam pentode or tetrode, the plate-grid capacitance of such tubes being sufficient to ensure stable oscillation but not so high as to offer excessive feedback with resulting high crystal current. The 6AG7 makes an excellent all-around tube for this type circuit.

Pentode Harmonic Crystal Oscillator Circuits The usual type of crystal-controlled h-f transmitter operates, at least part of the time, on a frequency which is an integral multiple of the operating frequency of the controlling crystal. Hence, oscillator circuits which are capable of providing output on the crystal frequency if desired, but which also can deliver output energy on harmonics of the crystal frequency have come into wide use. Four such circuits which have found wide application are illustrated in figures 7C, 7D, 7E, and 7F.

The circuit shown in figure 7C is recommended for use with harmonic-cut crystals when output is desired on a multiple of the oscillating frequency of the crystal. As an example, a 25-Mc. harmonic-cut crystal may be used in this circuit to obtain output on 50 Mc., or a 48-Mc. harmonic-cut crystal may be used to obtain output on the 144-Mc. amateur band. The circuit is not recommended for use with the normal type of fundamental-frequency crystal since more output with fewer variable elements can be obtained with the circuits of 7D and 7F.

The Pierce-harmonic circuit shown in figure 7D is satisfactory for many applications which require very low crystal current, but has the disadvantage that both sides of the crystal are above ground potential. The Tri-tet circuit of figure 7E is widely used and can

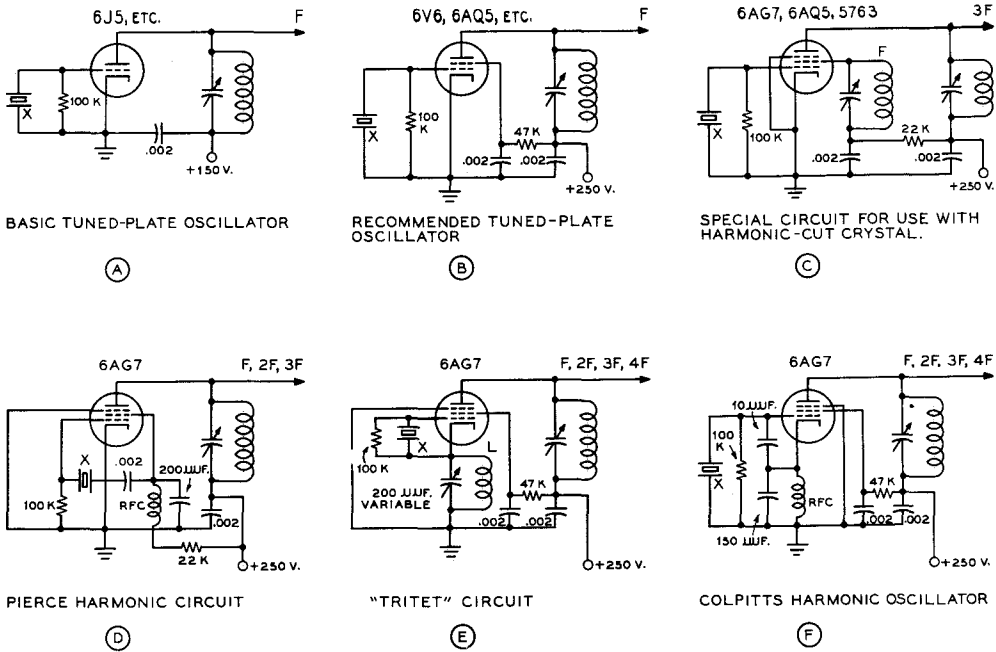

Figure 7
COMMONLY USED CRYSTAL OSCILLATOR CIRCUITS

Shown at (A) is the basic tuned-plate crystal oscillator with a triode oscillator tube. The plate tank must be tuned on the low-capacitance side of resonance to sustain oscillation. (B) shows the tuned-plate oscillator as it is normally used, with an a-f power pentode to permit high output with relatively low crystal current.

Schematics (C), (D), (E), and (F) illustrate crystal oscillator circuits which can deliver moderate output energy on harmonics of the oscillating frequency of the crystal. (C) shows a special circuit which will permit use of a harmonic-cut crystal to obtain output energy well into the v-h-f range. (D) is valuable when extremely low crystal current is a requirement, but delivers relatively low output. (E) is commonly used, but is subject to crystal damage if the cathode circuit is mistuned. (F) is recommended as the most generally satisfactory from the standpoints of: low crystal current regardless of mis-adjustment, good output on harmonic frequencies, one side of crystal is grounded, will oscillate with crystals from 1.5 to 10 Mc. without adjustment, output tank may be tuned to the crystal frequency for fundamental output without stopping oscillation or changing frequency.

give excellent output with low crystal current. However, the circuit has the disadvantages of requiring a cathode coil, of requiring careful setting of the variable cathode capacitor to avoid damaging the crystal when changing frequency ranges, and of having both sides of the crystal above ground potential.

The Colpitts harmonic oscillator of figure 7F is recommended as being the most generally satisfactory harmonic crystal oscillator circuit since it has the following advantages: (1) the circuit will oscillate with crystals over a very wide frequency range with no change other than plugging in or switching in the desired crystal; (2) crystal current is ex-

tremely low; (3) one side of the crystal is grounded, which facilitates crystal-switching circuits; (4) the circuit will operate straight through without frequency pulling, or it may be operated with output on the second, third, or fourth harmonic of the crystal frequency.

Crystal Oscillator Tuning The tunable circuits of all oscillators illustrated should be tuned for maximum output as indicated by maximum excitation to the following stage, except that the oscillator tank of tuned-plate oscillators (figure 7A and figure 7B) should be backed off slightly towards the low capacitance side from

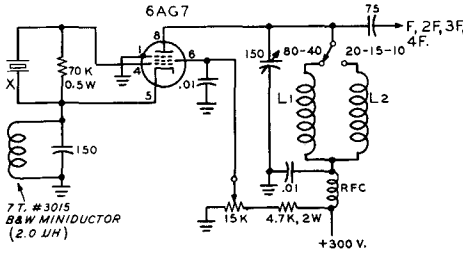

NOTES

1. $L_1 = 15 \mu H$ ($2\frac{1}{2}''$ OF B&W # 3015)
2. $L_2 = 1.6 \mu H$ ($1''$ OF B&W # 3003)
3. FOR 160 METER OPERATION ADD 5 $\mu U F$ CONDENSER BETWEEN PINS 4 & 8 OF 6AG7. PLATE COIL = 55 μH , ($2\frac{1}{2}''$ OF B&W # 3016)
4. X = 7 MC. CRYSTAL FOR HARMONIC OPERATION

Figure 8
ALL-BAND 6AG7 CRYSTAL OSCILLATOR
CAPABLE OF DRIVING
BEAM PENTODE TUBE

maximum output, as the oscillator then is in a more stable condition and sure to start immediately when power is applied. This is especially important when the oscillator is keyed, as for break-in c-w operation.

Crystal Switching It is desirable to keep stray shunt capacitances in the crystal circuit as low as possible, regardless of the oscillator circuit. If a selector switch is used, this means that both switch and crystal sockets must be placed close to the oscillator tube socket. This is especially true of harmonic-cut crystals operating on a comparatively high frequency. In fact, on the highest frequency crystals it is preferable to use a turret arrangement for switching, as the stray capacitances can be kept lower.

Crystal Oscillator Keying When the crystal oscillator is keyed, it is necessary that crystal activity and oscillator-tube transconductance be moderately high, and that oscillator loading and crystal shunt capacitance be low. Below 2500 kc. and above 6 Mc. these considerations become especially important. Keying of the plate voltage (in the negative lead) of a crystal oscillator, with the screen voltage regulated at about 150 volts, has been found to give satisfactory results.

A Versatile 6AG7 Crystal Oscillator The 6AG7 tube may be used in a modified Tri-tet crystal oscillator, capable of delivering sufficient power on all bands

from 160 meters through 10 meters to fully drive a pentode tube, such as the 807, 2E26 or 6146. Such an oscillator is extremely useful for portable or mobile work, since it combines all essential exciter functions in one tube. The circuit of this oscillator is shown in figure 8. For 160, 80 and 40 meter operation the 6AG7 functions as a tuned-plate oscillator. Fundamental frequency crystals are used on these three bands. For 20, 15 and 10 meter operation the 6AG7 functions as a Tri-tet oscillator with a fixed-tuned cathode circuit. The impedance of this cathode circuit does not affect operation of the 6AG7 on the lower frequency bands so it is left in the circuit at all times. A 7-Mc. crystal is used for fundamental output on 40 meters, and for harmonic output on 20, 15 and 10 meters. Crystal current is extremely low regardless of the output frequency of the oscillator. The plate circuit of the 6AG7 is capable of tuning a frequency range of 2:1, requiring only two output coils; one for 80-40 meter operation, and one for 20, 15 and 10 meter operation. In some

cases it may be necessary to add 5 micromicrofarads of external feedback capacity between the plate and control grid of the 6AG7 tube to sustain oscillation with sluggish 160 meter crystals.

Triode Overtone Oscillators The recent development of reliable overtone crystals capable of operation on the third, fifth, seventh (or higher) overtones has made possible v-h-f output from a low frequency crystal by the use of a double triode regenerative oscillator circuit. Some of the new twin triode tubes such as the 12AU7, 12AV7 and 6J6 are especially satisfactory when used in this type of circuit. Crystals that are ground for overtone service may be made to oscillate on odd overtone frequencies other than the one marked on the crystal holder. A 24-Mc. overtone crystal, for example, is a specially ground 8-Mc. crystal operating on its third overtone. In the proper circuit it may be made to oscillate on 40 Mc. (fifth overtone), 56 Mc. (seventh overtone), or 72 Mc. (ninth overtone). Even the ordinary 8-Mc. crystals not designed for overtone operation may be made to oscillate readily on 24 Mc. (third overtone) in these circuits.

A variety of overtone oscillator circuits is shown in figure 9. The oscillator of figure 9A is attributed to Frank Jones, W6AJF. The first section of the 6J6 dual triode comprises a regenerative oscillator, with output on either the third or fifth overtone of the crystal frequency. The regenerative loop of this oscillator consists of a condenser bridge made up of C_1 and C_2 , with the ratio C_2/C_1 determining the amount of regenerative feedback in the circuit. With

back should be employed to maintain proper oscillation of the crystal. Excessive feedback will cause the first section of the 12AU7 to oscillate as a self-excited TNT oscillator, independent of the crystal. A variety of this circuit is shown in figure 9D, wherein a tapped coil, L_1 , is used in place of the two separate coils. Operation of the circuit is the same in either case, regeneration now being controlled by the placement of the tap on L_1 .

A cathode follower overtone oscillator is shown in figure 9E. The cathode coil, L_1 , is chosen so as to resonate with the crystal and tube capacities *just below* the third overtone frequency of the crystal. For example, with an 8-Mc. crystal, L_1 is tuned to 24 Mc., L_1 resonates with the circuit capacities to 23.5 Mc., and the harmonic tank circuit of the second section of the 12AT7 is tuned either to 48 Mc. or 72 Mc. If a 24-Mc. overtone crystal is used in this circuit, L_2 may be tuned to 72 Mc., L_1 resonates with the circuit capacities to 70 Mc., and the harmonic tank circuit, L_2 , is tuned to 144 Mc. If there is any tendency towards self-oscillation in the circuit, it may be eliminated by a small amount of inductive coupling between L_2 and L_3 . Placing these coils near each other, with the winding of L_2 correctly polarized with respect to L_3 will prevent self-oscillation of the circuit.

The use of a 144-Mc. overtone crystal is illustrated in figure 9F. A 6AB4 or one-half of a 12AT7 tube may be used, with output directly in the 2-meter amateur band. A slight amount of regeneration is provided by the one turn link, L_2 , which is loosely coupled to the 144-Mc. tuned tank circuit, L_1 in the plate circuit of the oscillator tube. If a 12AT7 tube and a 110-Mc. crystal are employed, direct output in the 220-Mc. amateur band may be obtained from the second half of the 12AT7.

13-4 Radio Frequency Amplifiers

The output of the oscillator stage in a transmitter (whether it be self-controlled or crystal controlled) must be kept down to a fairly low level to maintain stability and to maintain a factor of safety from fracture of the crystal when one is used. The low power output of the oscillator is brought up to the desired power level by means of radio-frequency amplifiers. The two classes of r-f amplifiers that find widest application in radio transmitters are the Class B and Class C types.

The Class B Amplifier Class B amplifiers are used in a radio-telegraph transmitter when maximum power gain and mini-

mum harmonic output is desired in a particular stage. A Class B amplifier operates with cutoff bias and a comparatively small amount of excitation. Power gains of 20 to 200 or so are obtainable in a well-designed Class B amplifier. The plate efficiency of a Class B c-w amplifier will run around 65 per cent.

The Class B Linear Amplifier Another type of Class B amplifier is the Class B linear stage as employed in radiophone work.

This type of amplifier is used to increase the level of a modulated carrier wave, and depends for its operation upon the linear relation between excitation voltage and output voltage. Or, to state the fact in another manner, the power output of a Class B linear stage varies linearly with the square of the excitation voltage.

The Class B linear amplifier is operated with cutoff bias and a small value of excitation, the actual value of exciting power being such that the power output under carrier conditions is one-fourth of the peak power capabilities of the stage. Class B linears are very widely employed in broadcast and commercial installations, but are comparatively uncommon in amateur application, since tubes with high plate dissipation are required for moderate output. The carrier efficiency of such an amplifier will vary from approximately 30 per cent to 35 per cent.

The Class C Amplifier Class C amplifiers are very widely used in all types of transmitters. Good power gain may be obtained (values of gain from 3 to 20 are common) and the plate circuit efficiency may be, under certain conditions, as high as 85 per cent. Class C amplifiers operate with considerably more than cutoff bias and ordinarily with a large amount of excitation as compared to a Class B amplifier. The bias for a normal Class C amplifier is such that plate current on the stage flows for approximately 120° of the 360° excitation cycle. Class C amplifiers are used in transmitters where a fairly large amount of excitation power is available and good plate circuit efficiency is desired.

Plate Modulated Class C Amplifier The characteristic of a Class C amplifier which makes it linear with respect to changes in plate voltage is that which allows such an amplifier to be *plate modulated* for radiotelephony. Through the use of higher bias than is required for a c-w Class C amplifier and greater excitation, the linearity of such an amplifier may be extended from zero plate voltage to twice the normal value. The output power of a Class C amplifier, adjusted for plate modulation, varies with the square of the

plate voltage. This is the same condition that would take place if a resistor equal to the voltage on the amplifier, divided by its plate current, were substituted for the amplifier. Therefore, the stage presents a resistive load to the modulator.

Grid Modulated Class C If the grid current to a Class C amplifier is reduced to a low value, and the plate loading is increased to the point where the plate dissipation approaches the rated value, such an amplifier may be grid modulated for radio-telephony. If the plate voltage is raised to quite a high value and the stage is adjusted carefully, efficiencies as high as 40 to 43 per cent with good modulation capability and comparatively low distortion may be obtained. Fixed bias is required. This type of operation is termed Class C grid-bias modulation.

Grid Excitation Adequate grid excitation must be available for Class B or Class C service. The excitation for a plate-modulated Class C stage must be sufficient to produce a normal value of d-c grid current with rated bias voltage. The bias voltage preferably should be obtained from a combination of grid leak and fixed C-bias supply.

Cutoff bias can be calculated by dividing the amplification factor of the tube into the d-c plate voltage. This is the value normally used for Class B amplifiers (fixed bias, no grid resistor). Class C amplifiers use from $1\frac{1}{2}$ to 5 times this value, depending upon the available grid drive, or excitation, and the desired plate efficiency. Less grid excitation is needed for c-w operation, and the values of fixed bias (if greater than cutoff) may be reduced, or the value of the grid leak resistor can be lowered until normal rated d-c grid current flows.

The values of grid excitation listed for each type of tube may be reduced by as much as 50 per cent if only moderate power output and plate efficiency are desired. When consulting the tube tables, it is well to remember that the power lost in the tuned circuits must be taken into consideration when calculating the available grid drive. At very high frequencies, the r-f circuit losses may even exceed the power required for actual grid excitation.

Link coupling between stages, particularly to the final amplifier grid circuit, normally will provide more grid drive than can be obtained from other coupling systems. The number of turns in the coupling link, and the location of the turns on the coil, can be varied with respect to the tuned circuits to obtain the greatest grid drive for allowable values of buffer or doubler plate current. Slight readjustments sometimes can be made after plate voltage has been applied to the driver tube.

Excessive grid current damages tubes by overheating the grid structure; beyond a certain point of grid drive, no increase in power output can be obtained for a given plate voltage.

13-5 Neutralization of R.F. Amplifiers

The plate-to-grid feedback capacitance of triodes makes it necessary that they be neutralized for operation as r-f amplifiers at frequencies above about 500 kc. Those screen-grid tubes, pentodes, and beam tetrodes which have a plate-to-grid capacitance of $0.1 \mu\text{mfd.}$ or less may be operated as an amplifier without neutralization in a well-designed amplifier up to 30 Mc.

Neutralizing Circuits The object of *neutralization* is to cancel or neutralize the capacitive feedback of energy from plate to grid. There are two general methods by which this energy feedback may be eliminated: the first, and the most common method, is through the use of a capacitance bridge, and the second method is through the use of a parallel reactance of equal and opposite polarity to the grid-to-plate capacitance, to nullify the effect of this capacitance.

Examples of the first method are shown in figure 10. Figure 10A shows a capacity neutralized stage employing a balanced tank circuit. Phase reversal in the tank circuit is obtained by grounding the center of the tank coil to radio frequency energy by condenser C. Points A and B are 180 degrees out of phase with each other, and the correct amount of out of phase energy is coupled through the neutralizing condenser NC to the grid circuit of the tube. The equivalent bridge circuit of this is shown in figure 11A. It is seen that the bridge is not in balance, since the plate-filament capacity of the tube forms one leg of the bridge, and there is no corresponding capacity from the neutralizing condenser (point B) to ground to obtain a complete balance. In addition, it is mechanically difficult to obtain a perfect electrical balance in the tank coil, and the potential between point A and ground and point B and ground in most cases is unequal. This circuit, therefore, holds neutralization over a very small operating range and unless tubes of low interelectrode capacity are used the inherent unbalance of the circuit will permit only approximate neutralization.

Split-Stator Plate Neutralization

Figure 10B shows the neutralization circuit which is most widely used in single-ended r-f stages. The use of

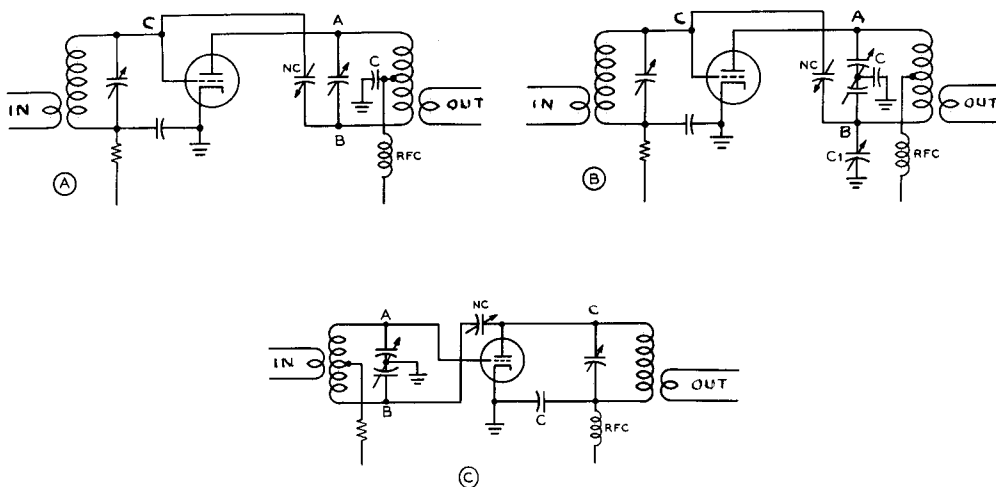

Figure 10
COMMON NEUTRALIZING CIRCUITS FOR SINGLE-ENDED AMPLIFIERS

a split-stator plate capacitor makes the electrical balance of the circuit substantially independent of the mutual coupling within the coil and also makes the balance independent of the place where the coil is tapped. With conventional tubes this circuit will allow one neutralization adjustment to be made on, say, 28 Mc., and this adjustment usually will hold sufficiently close for operation on all lower frequency bands.

Condenser C_1 is used to balance out the plate-filament capacity of the tube to allow a perfect neutralizing balance at all frequencies. The equivalent bridge circuit is shown in figure 11B. If the plate-filament capacity of the tube is extremely low (100TH triode, for example), condenser C_1 may be omitted, or may merely consist of the residual capacity of NC to ground.

Grid Neutralization A split grid tank circuit may also be used for neutralization of a triode tube as shown in figure 10C. Out of phase voltage is developed across a balanced grid circuit, and coupled through NC to the single-ended plate circuit of the tube. The equivalent bridge circuit is shown in figure 11C. This circuit is in balance until the stage is in operation when the loading effect of the tube upon one-half of the grid circuit throws the bridge circuit out of balance. The amount of unbalance depends upon the grid-plate capacity of the tube, and the amount of mutual inductance between the two halves

of the grid coil. If an r-f voltmeter is placed between point A and ground, and a second voltmeter placed between point B and ground the loading effect of the tube will be noticeable. When the tube is supplied excitation with no plate voltage, NC may be adjusted until the circuit is in balance. When plate voltage is applied to the stage, the voltage from point A to ground will decrease, and the voltage from point B to ground will increase, both in direct proportion to the amount of circuit unbalance. The use of this circuit is not recommended above 7 Mc., and it should be used below that frequency only with low internal capacity tubes.

Push-Pull Neutralization Two tubes of the same type can be connected for *push-pull* operation so as to obtain twice as much output as that of a single tube. A push-pull amplifier, such as that shown in figure 12 also has an advantage in that the circuit can more easily be balanced than a single-tube r-f amplifier. The various inter-electrode capacitances and the neutralizing capacitors are connected in such a manner that the reactances on one side of the tuned circuits are exactly equal to those on the opposite side. For this reason, push-pull r-f amplifiers can be more easily neutralized in very-high-frequency transmitters; also, they usually remain in perfect neutralization when tuning the amplifier to different bands.

The circuit shown in figure 12 is perhaps

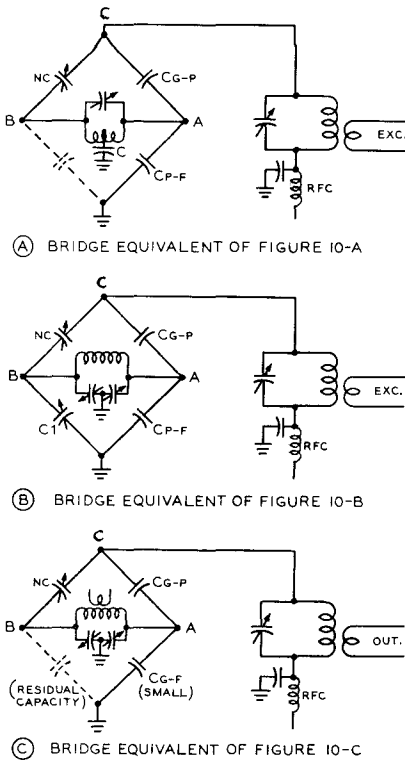

Figure 11

EQUIVALENT NEUTRALIZING CIRCUITS

the most commonly used arrangement for a push-pull r-f amplifier stage. The rotor of the grid capacitor is grounded, and the rotor of the plate tank capacitor is by-passed to ground.

Shunt or Coil Neutralization The feedback of energy from grid to plate in an unneutralized r-f amplifier is a result of the grid-to-plate capacitance of the amplifier tube. A neutralization circuit is merely an electrical arrangement for nullifying the effect of this capacitance. All the previous neutralization circuits have made use of a bridge circuit for balancing out the grid-to-plate energy feedback by feeding back an equal amount of energy of opposite phase.

Another method of eliminating the feedback effect of this capacitance, and hence of neutralizing the amplifier stage, is shown in figure 13. The grid-to-plate capacitance in the triode amplifier tube acts as a capacitive re-

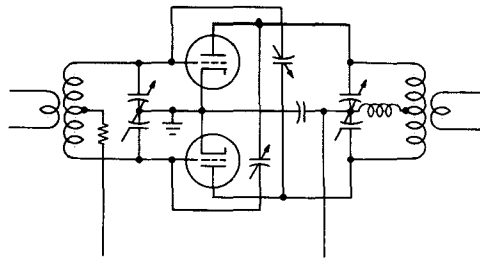

Figure 12
STANDARD CROSS-NEUTRALIZED
PUSH-PULL TRIODE AMPLIFIER

actance, coupling energy back from the plate to the grid circuit. If this capacitance is paralleled with an inductance having the same value of reactance of opposite sign, the reactance of one will cancel the reactance of the other and a high-impedance tuned circuit from grid to plate will result.

This neutralization circuit can be used on ultra-high frequencies where other neutralization circuits are unsatisfactory. This is true because the lead length in the neutralization circuit is practically negligible. The circuit can also be used with push-pull r-f amplifiers. In this case, each tube will have its own neutralizing inductor connected from grid to plate.

The main advantage of this arrangement is that it allows the use of single-ended tank circuits with a single-ended amplifier.

The chief disadvantage of the shunt neutralized arrangement is that the stage must be re-neutralized each time the stage is retuned to a new frequency sufficiently removed that the grid and plate tank circuits must be retuned to resonance. However, by the use of plug-in coils it is possible to change to a different band of operation by changing the neutralizing coil at the same time that the grid and plate coils are changed.

The 0.0001- μ f capacitor in series with the neutralizing coil is merely a blocking capacitor to isolate the plate voltage from the grid circuit. The coil L will have to have a very large number of turns for the band of operation in order to be resonant with the comparatively small grid-to-plate capacitance. But since, in all ordinary cases with tubes operating on frequencies for which they were designed, the L/C ratio of the tuned circuit will be very high, the coil can use comparatively small wire, although it must be wound on air or very low loss dielectric and must be insulated for the sum of the plate r-f voltage and the grid r-f voltage.

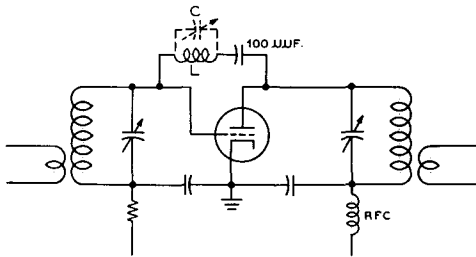

Figure 13

COIL NEUTRALIZED AMPLIFIER

This neutralization circuit is very effective with triode tubes on any frequency, but is particularly effective in the v-h-f range. The coil L is adjusted so that it resonates at the operating frequency with the grid-to-plate capacitance of the tube. Capacitor C may be a very small unit of the low-capacitance neutralizing type and is used to trim the circuit to resonance at the operating frequency. If some means of varying the inductance of the coil a small amount is available, the trimmer capacitor is not needed.

13-6

Neutralizing Procedure

An r-f amplifier is neutralized to prevent self-oscillation or regeneration. A neon bulb, a flashlight lamp and loop of wire, or an r-f galvanometer can be used as a *null indicator* for neutralizing low-power stages. The plate voltage lead is disconnected from the r-f amplifier stage while it is being neutralized. Normal grid drive then is applied to the r-f stage, the neutralizing indicator is coupled to the plate coil, and the plate tuning capacitor is tuned to resonance. The neutralizing capacitor (or capacitors) then can be adjusted until *minimum* r.f. is indicated for resonant settings of both grid and plate tuning capacitors. Both neutralizing capacitors are adjusted simultaneously and to approximately the same value of capacitance when a physically symmetrical push-pull stage is being neutralized.

A final check for neutralization should be made with a d-c milliammeter connected in the grid leak or grid-bias circuit. There will be no movement of the meter reading as the plate circuit is tuned through resonance (without plate voltage being applied) when the stage is completely neutralized.

Plate voltage should be *completely* removed by actually opening the d-c plate circuit. If there is a d-c return through the plate supply, a small amount of plate current will flow when

grid excitation is applied, even though no primary a-c voltage is being fed to the plate transformer.

A further check on the neutralization of any r-f amplifier can be made by noting whether maximum grid current on the stage comes at the same point of tuning on the plate tuning capacitor as minimum plate current. This check is made with plate voltage on the amplifier and with normal antenna coupling. As the plate tuning capacitor is detuned *slightly* from resonance on either side the grid current on the stage should *decrease* the same amount and without any sudden jumps on either side of resonance. This will be found to be a very precise indication of accurate neutralization in either a triode or beam-tetrode r-f amplifier stage, so long as the stage is feeding a load which presents a resistive impedance at the operating frequency.

Push-pull circuits usually can be more completely neutralized than single-ended circuits at very high frequencies. In the intermediate range of from 3 to 15 Mc., single-ended circuits will give satisfactory results.

Neutralization of Screen-Grid R-F Amplifiers

Radio-frequency amplifiers using screen-grid tubes can be operated without any additional provision for neutralization at frequencies up to about 15 Mc., provided adequate shielding has been provided between the input and output circuits. Special v-h-f screen-grid and beam tetrode tubes such as the 2E26, 807W, and 5516 in the low-power category and HK-257B, 4E27/8001, 4-125A, and 4-250A in the medium-power category can frequently be operated at frequencies as high as 100 Mc. without any additional provision for neutralization. Tubes such as the 807, 2E22, HY-69, and 813 can be operated with good circuit design at frequencies up to 30 Mc. without any additional provision for neutralization. The 815 tube has been found to require neutralization in many cases above 20 Mc., although the 829B tube will operate quite stably at 100 Mc. without neutralization.

None of these tubes, however, has perfect shielding between the grid and the plate, a condition brought about by the inherent inductance of the screen leads within the tube itself. In addition, unless "watertight" shielding is used between the grid and plate circuits of the tube a certain amount of external leakage between the two circuits is present. These difficulties may not be serious enough to require neutralization of the stage to prevent oscillation, but in many instances they show up in terms of key-clicks when the stage in question is keyed, or as parasitics when the stage is modulated. Unless the designer of the equipment can carefully check the tetrode

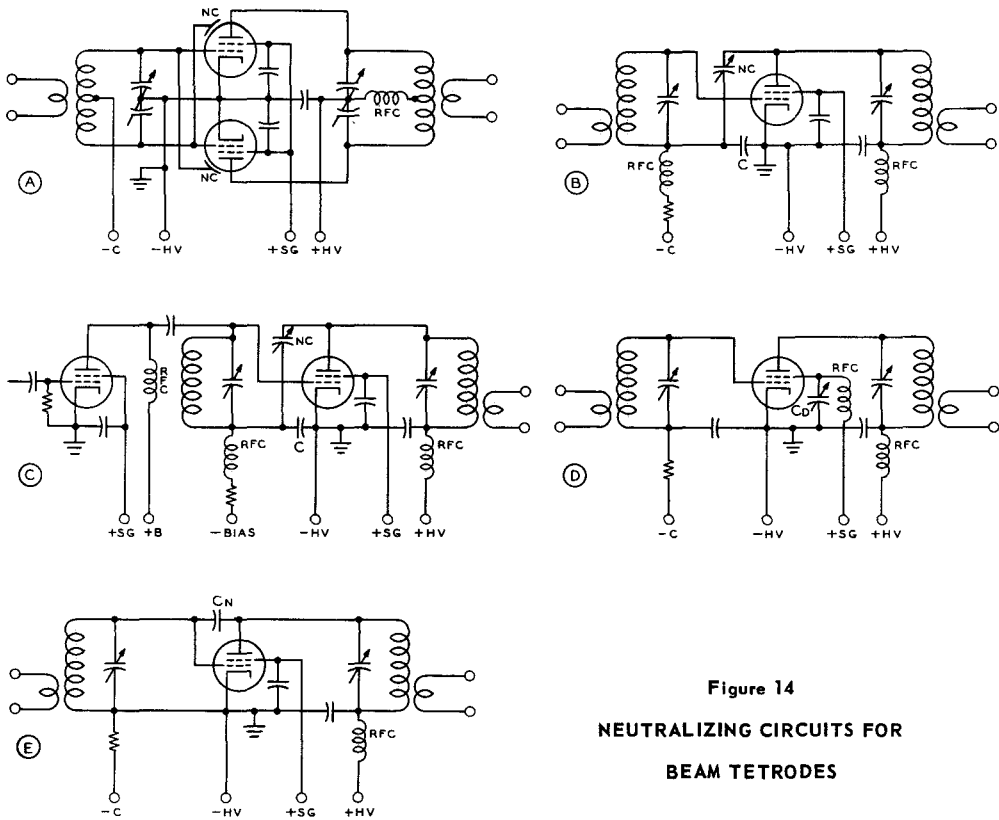

Figure 14
NEUTRALIZING CIRCUITS FOR
BEAM TETRODES

A conventional cross neutralized circuit for use with push-pull beam tetrodes is shown at (A). The neutralizing capacitors (NC) usually consist of small plates or rods mounted alongside the plate elements of the tubes. (B) and (C) show "grid neutralized" circuits for use with a single-ended tetrode stage having either link coupling or capacitive coupling into the grid tank. (D) shows a method of tuning the screen-lead inductance to accomplish neutralization in a single-frequency v-h-f tetrode amplifier, while (E) shows a method of neutralization by increasing the grid-to-plate capacitance on a tetrode when the operating frequency is higher than that frequency where the tetrode is "self-neutralized" as a result of series resonance in the screen lead. Methods (D) and (E) normally are not practicable at frequencies below about 50 Mc. with the usual types of beam tetrode tubes.

stage for miscellaneous feedback between the grid and plate circuits, and make the necessary circuit revisions to reduce this feedback to an absolute minimum, it is wise to neutralize the tetrode just as if it were a triode tube.

In most push-pull tetrode amplifiers the simplest method of accomplishing neutralization is to use the cross-neutralized capacitance bridge arrangement as normally employed with triode tubes. The neutralizing capacitances, however, must be very much smaller than used with triode tubes, values of the order of 0.2 μfd . normally being required with beam tetrode

tubes. This order of capacitance is far less than can be obtained with a conventional neutralizing capacitor at minimum setting, so the neutralizing arrangement is most commonly made especially for the case at hand. Most common procedure is to bring a conductor (connected to the opposite grid) in the vicinity of the plate itself or of the plate tuning capacitor of one of the tubes. Either one or two such capacitors may be used, two being normally used on a higher frequency amplifier in order to maintain balance within the stage.

An example of this is shown in figure 14A.

Neutralizing Single-Ended Tetrode Stages A single-ended tetrode r-f amplifier stage may be neutralized in the same manner as illustrated for a push-pull stage in figure 14A, provided a split-stator tank capacitor is in use in the plate circuit. However, in the majority of single-ended tetrode r-f amplifier stages a single-section capacitor is used in the plate tank. Hence, other neutralization procedures must be employed when neutralization is found necessary.

The circuit shown in figure 14B is not a true neutralizing circuit, in that the plate-to-grid capacitance is not balanced out. However, the circuit can afford the equivalent effect by isolating the high resonant impedance of the grid tank circuit from the energy fed back from plate to grid. When NC and C are adjusted to bear the following ratio to the grid-to-plate capacitance and the total capacitance from grid-to-ground in the output tube:

$$\frac{NC}{C} = \frac{C_{gp}}{C_{gk}}$$

both ends of the grid tank circuit will be at the same voltage with respect to ground as a result of r-f energy fed back to the grid circuit. This means that the impedance from grid to ground will be effectively equal to the reactance of the grid-to-cathode capacitance in parallel with the stray grid-to-ground capacitance, since the high resonant impedance of the tuned circuit in the grid has been effectively isolated from the feedback path. It is important to note that the effective grid-to-ground capacitance of the tube being neutralized includes the r-f grid-to-cathode or input capacitance of the tube, the capacitance of the socket, wiring capacitances and other strays, but it does *not* include the capacitances associated with the grid tuning capacitor. Also, if the tube is being excited by capacitive coupling from a preceding stage (as in figure 14C), the effective grid-to-ground capacitance includes the output capacitance of the preceding stage and its associated socket and wiring capacitances.

Cancellation of Screen-Lead Inductance The provisions discussed in the previous paragraphs are for neutralization of the small, though still important at the higher frequencies, grid-to-plate capacitance of beam-tetrode tubes. However, in the vicinity of the upper-frequency limit of each tube type the inductance of the screen lead of the tube becomes of considerable importance. With a tube operating at a frequency where the inductance of the screen lead is appreciable, the screen will allow a considerable amount of energy leak-through from plate to grid even

though the socket terminal on the tube is carefully by-passed to ground. This condition takes place even though the socket pin is bypassed since the reactance of the screen lead will allow a moderate amount of r-f potential to appear on the screen itself inside the electrode assembly in the tube. This effect has been reduced to a very low amount in such tubes as the Hytron 5516, and the Eimac 4X150A and 4X500A but it is still quite appreciable in most beam-tetrode tubes.

The effect of screen-lead inductance on the stability of a stage can be eliminated at any particular frequency by one of two methods. These methods are: (1) Tuning out the screen-lead inductance by series resonating the screen lead inductance with a capacitor to ground. This method is illustrated in figure 14D and is commonly employed in commercially-built equipment for operation on a narrow frequency band in the range above about 75 Mc. The other method (2) is illustrated in figure 14E and consists in feeding back additional energy from plate to grid by means of a small capacitor connected between these two elements. Note that this capacitor is connected in such a manner as to *increase* the effective grid-to-plate capacitance of the tube. This method has been found to be effective with 807 tubes in the range above 50 Mc. and with tubes such as the 4-125A and 4-250A in the vicinity of their upper frequency limits.

Note that both these methods of stabilizing a beam-tetrode v-h-f amplifier stage by cancellation of screen-lead inductance are suitable only for operation over a relatively narrow band of frequencies in the v-h-f range. At lower frequencies both these expedients for reducing the effects of screen-lead inductance will tend to increase the tendency toward oscillation of the amplifier stage.

Neutralizing Problems When a stage cannot be completely neutralized, the difficulty usually can be traced to one or more of the following causes: (1) Filament leads not by-passed to the common ground of that particular stage. (2) Ground lead from the rotor connection of the split-stator tuning capacitor to filament open or too long. (3) Neutralizing capacitors in a field of excessive r.f. from one of the tuning coils. (4) Electromagnetic coupling between grid and plate coils, or between plate and preceding buffer or oscillator circuits. (5) Insufficient shielding or spacing between stages, or between grid and plate circuits in compact transmitters. (6) Shielding placed too close to plate circuit coils, causing induced currents in the shields. (7) Parasitic oscillations when plate voltage is applied. The cure for the latter is mainly a matter of cut and try—rearrange the parts,

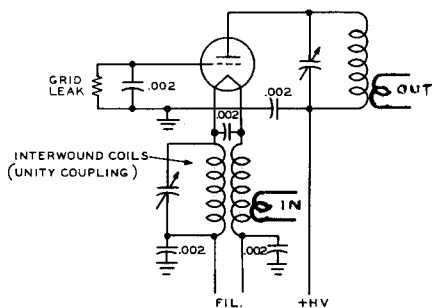

Figure 15
GROUNDED-GRID AMPLIFIER

This type of triode amplifier requires no neutralization, but can be used only with tubes having a relatively low plate-to-cathode capacitance

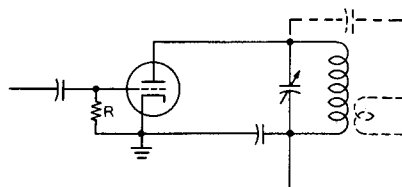

Figure 16
CONVENTIONAL TRIODE FREQUENCY MULTIPLIER

Small triodes such as the 6C4 operate satisfactorily as frequency multipliers, and can deliver output well into the v-h-f range. Resistor R normally will have a value in the vicinity of 100,000 ohms.

change the length of grid or plate or neutralizing leads, insert a parasitic choke in the grid lead or leads, or eliminate the grid r-f chokes which may be the cause of a low-frequency parasitic (in conjunction with plate r-f chokes).

13-7 Grounded Grid Amplifiers

Certain triodes have a grid configuration and lead arrangement which results in very low plate to filament capacitance when the control grid is grounded, the grid acting as an effective shield much in the manner of the screen in a screen-grid tube.

By connecting such a triode in the circuit of figure 15, taking the usual precautions against stray capacitive and inductive coupling between input and output leads and components, a stable power amplifier is realized which requires no neutralization.

At ultra-high frequencies, where it is difficult to obtain satisfactory neutralization with conventional triode circuits (particularly when a wide band of frequencies is to be covered), the grounded-grid arrangement is about the only practicable means of employing a triode amplifier.

Because of the large amount of degeneration inherent in the circuit, considerably more excitation is required than if the same tube were employed in a conventional grounded-cathode circuit. The additional power required to drive a triode in a grounded-grid amplifier is not lost, however, as it shows up in the output circuit and adds to the power delivered to the load. But nevertheless it means that a larger driver stage is required for an amplifier of

given output, because a moderate amount of power is delivered to the amplifier load by the driver stage of a grounded-grid amplifier.

13-8 Frequency Multipliers

Quartz crystals and variable-frequency oscillators are not ordinarily used for direct control of the output of high-frequency transmitters. *Frequency multipliers* are usually employed to multiply the frequency to the desired value. These multipliers operate on exact multiples of the excitation frequency; a 3.6-Mc. crystal oscillator can be made to control the output of a transmitter on 7.2 or 14.4 Mc., or on 28.8 Mc., by means of one or more frequency multipliers. When used at twice frequency, they are often termed *frequency doublers*. A simple doubler circuit is shown in figure 16. It consists of a vacuum tube with its plate circuit tuned to *twice* the frequency of the grid driving circuit. This doubler can be excited from a crystal oscillator or another multiplier or amplifier stage.

Doubling is best accomplished by operating the tube with high grid bias. The grid circuit is driven approximately to the normal value of d-c grid current through the r-f choke and grid-leak resistor, shown in figure 16. The resistance value generally is from two to five times as high as that used with the same tube for straight amplification. Consequently, the grid bias is several times as high for the same value of grid current.

Neutralization is seldom necessary in a doubler circuit, since the plate is tuned to twice the frequency of the grid circuit. The impedance of the grid driving circuit is very low at the doubling frequency, and thus there is little tendency for self-excited oscillation.

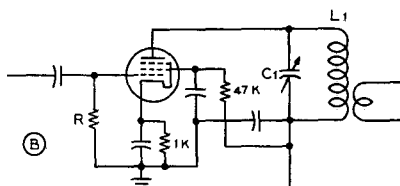
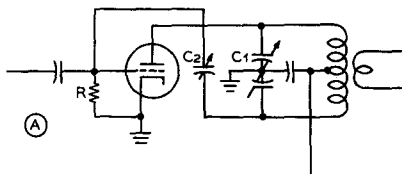

Figure 17

FREQUENCY MULTIPLIER CIRCUITS

The output of a triode v-h-f frequency multiplier often may be increased by neutralization of the grid-to-plate capacitance as shown at (A) above. Such a stage also may be operated as a straight amplifier when the occasion demands. A pentode frequency multiplier is shown at (B). Conventional power tetrodes operate satisfactorily as multipliers so long as the output frequency is below about 100 Mc. Above this frequency special v-h-f tetrodes must be used to obtain satisfactory output.

Frequency doublers require bias of several times cutoff; high- μ tubes therefore are desirable for this type of service. Tubes which have amplification factors from 20 to 200 are suitable for doubler circuits. Tetrodes and pentodes make excellent doublers. Low- μ triodes, having amplification constants of from 3 to 10, are not applicable for doubler service. In extreme cases the grid voltage must be as high as the plate voltage for efficient doubling action.

Angle of Flow in Frequency Multipliers The angle of plate current flow in a frequency multiplier is a very important factor in determining the efficiency. As the angle of flow is decreased for a given value of grid current, the efficiency increases. To reduce the angle of flow, higher grid bias is required so that the grid excitation voltage will exceed the cutoff value for a shorter portion of the exciting-voltage cycle. For a high order of efficiency, frequency doublers should have an angle of flow of 90 degrees or less, triplers 60 degrees or less, and quadruplers

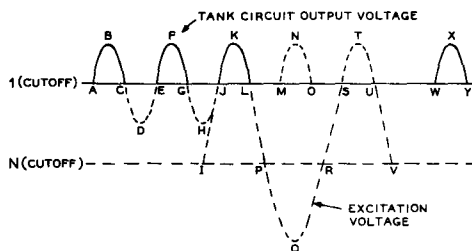

Figure 18
ILLUSTRATING THE ACTION OF A FREQUENCY DOUBLER

45 degrees or less. Under these conditions the efficiency will be on the same order as the reciprocal of the harmonic on which the stage operates. In other words the efficiency of a doubler will be approximately $\frac{1}{2}$ or 50 per cent, the efficiency of a tripler will be approximately $\frac{1}{3}$ or 33 per cent and that of a quadrupler will be about 25 per cent. With good stage design the efficiency can be somewhat greater than these values, but as the angle of flow is made greater than these limiting values, the efficiency falls off rapidly. The reason is apparent from a study of figure 18.

The pulses ABC, EFG, JKL illustrate 180-degree excitation pulses under Class B operation, the solid straight line indicating cutoff bias. If the bias is increased by N times, to the value indicated by the dotted straight line, and the excitation increased until the peak r-f voltage with respect to ground is the same as before, then the excitation frequency can be cut in half and the effective excitation pulses will have almost the same shape as before. The only difference is that every other pulse is missing; MNO simply shows where the missing pulse would go. However, if the Q of the plate tank circuit is high, it will have sufficient *flywheel effect* to carry over through the missing pulse, and the only effect will be that the plate input and r-f output at optimum loading drop to approximately half. As the input frequency is half the output frequency, an efficient frequency doubler is the result.

By the same token, a tripler or quadrupler can be analyzed, the tripler skipping two excitation pulses and the quadrupler three. In each case the excitation pulse ideally should be short enough that it does not exceed 180 degrees at the output frequency; otherwise the excitation actually is *bucking* the output over a portion of the cycle.

In actual practice, it is found uneconomical to provide sufficient excitation to run a tripler or quadrupler in this fashion. Usually the ex-

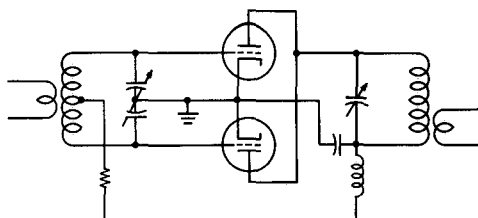

Figure 19

PUSH-PUSH FREQUENCY DOUBLER

The output of a doubler stage may be materially increased through the use of a push-push circuit such as illustrated above.

citation pulses will be at least 90 degrees at the exciting frequency, with correspondingly low efficiency, but it is more practicable to accept the low efficiency and build up the output in succeeding amplifier stages. The efficiency can become quite low before the power gain becomes less than unity.

Push-Push Multipliers Two tubes can be connected in parallel to give twice the output of a single-tube doubler. If the grids are driven *out* of phase instead of *in* phase, the tubes then no longer work simultaneously, but rather one at a time. The effect is to fill in the missing pulses (figure 18). Not only is the output doubled, but several advantages accrue which cannot be obtained by straight parallel operation.

Chief among these is the effective neutralization of the fundamental and all *odd* harmonics, an advantage when spurious emissions must be minimized. Another advantage is that when the available excitation is low and excitation pulses exceed 90 degrees, the output and efficiency will be greater than for the same tubes connected in parallel.

The same arrangement may be used as a quadrupler, with considerably better efficiency than for straight parallel operation, because seldom is it practicable to supply sufficient excitation to permit 45 degree excitation pulses. As pointed out above, the push-push arrangement exhibits better efficiency than a single ended multiplier when excitation is inadequate for ideal multiplier operation.

A typical push-push doubler is illustrated in figure 19. When high transconductance tubes are employed, it is necessary to employ a split-stator grid tank capacitor to prevent self oscillation; with well screened tetrodes or pentodes having medium values of transconductance, a split-coil arrangement with a single-section capacitor may be employed (the

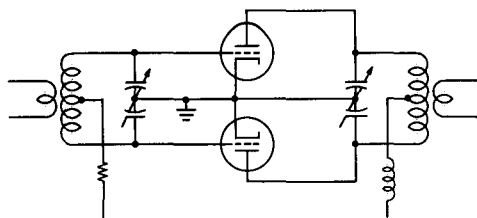

Figure 20

PUSH-PULL FREQUENCY TRIPLER

The push-pull tripler is advantageous in the v-h-f range since circuit balance is maintained both in the input and output circuits. If the circuit is neutralized it may be used either as a straight amplifier or as a tripler. Either triodes or tetrodes may be used; dual-unit tetrodes such as the 815, 832A, and 829B are particularly effective in the v-h-f range.

center tap of the grid coil being by-passed to ground).

Push-Pull Frequency Triplers It is frequently desirable in the case of u-h-f and v-h-f transmitters that

frequency multiplication stages be balanced with respect to ground. Further it is just as easy in most cases to multiply the crystal or v-f-o frequency by powers of three rather than multiplying by powers of two as is frequently done on lower frequency transmitters. Hence the use of push-pull triplers has become quite prevalent in both commercial and amateur v-h-f and u-h-f transmitter designs. Such stages are balanced with respect to ground and appear in construction and on paper essentially the same as a push-pull r-f amplifier stage with the exception that the output tank circuit is tuned to three times the frequency of the grid tank circuit. A circuit for a push-pull tripler stage is shown in figure 20.

A push-pull tripler stage has the further advantage in amateur work that it can also be used as a conventional push-pull r-f amplifier merely by changing the grid and plate coils so that they tune to the same frequency. This is of some advantage in the case of operating the 50-Mc. band with 50-Mc. excitation, and then changing the plate coil to tune to 144 Mc. for operation of the stage as a tripler from excitation on 48 Mc. This circuit arrangement is excellent for operation with push-pull beam tetrodes such as the 6360 and 829B, although a pair of tubes such as the 2E26, or 5763 could just as well be used if proper attention were given to the matter of screen-lead inductance.

13-9 Tank Circuit Capacitances

It is necessary that the proper value of Q be used in the plate tank circuit of any r-f amplifier. The following section has been devoted to a treatment of the subject, and charts are given to assist the reader in the determination of the proper L/C ratio to be used in a radio-frequency amplifier stage.

A Class C amplifier draws plate current in the form of very distorted pulses of short duration. Such an amplifier is always operated into a tuned inductance-capacitance or tank circuit which tends to smooth out these pulses, by its storage or tank action, into a sine wave of radio-frequency output. Any wave-form distortion of the carrier frequency results in harmonic interference in higher-frequency channels.

A Class A r-f amplifier would produce a sine wave of radio-frequency output if its exciting waveform were also a sine wave. However, a Class A amplifier stage converts its d-c input to r-f output by acting as a variable resistance, and therefore heats considerably. A Class C amplifier when driven hard with short pulses at the peak of the exciting waveform acts more as an electronic switch, and therefore can convert its d-c input to r-f output with relatively good efficiency. Values of plate circuit efficiency from 65 to 85 per cent are common in Class C amplifiers operating under optimum conditions of excitation, grid bias, and loading.

Tank Circuit Q As stated before, the tank circuit of a Class C amplifier receives energy in the form of short pulses of plate current which flow in the amplifier tube. But the tank circuit must be able to store enough energy so that it can deliver a current essentially sine wave in form to the load. The ability of a tank to store energy in this manner may be designated as the effective Q of the tank circuit. The effective circuit Q may be stated in any of several ways, but essentially the Q of a tank circuit is the *ratio of the energy stored to 2π times the energy lost per cycle*. Further, the *energy lost per cycle* must, by definition, be equal to the *energy delivered* to the tank circuit by the Class C amplifier tube or tubes.

The Q of a tank circuit at resonance is equal to its parallel resonant impedance (the resonant impedance is resistive at resonance) divided by the reactance of either the capacitor or the inductor which go to make up the tank. The inductive reactance is equal to the capacitive reactance, by definition, at resonance. Hence we may state:

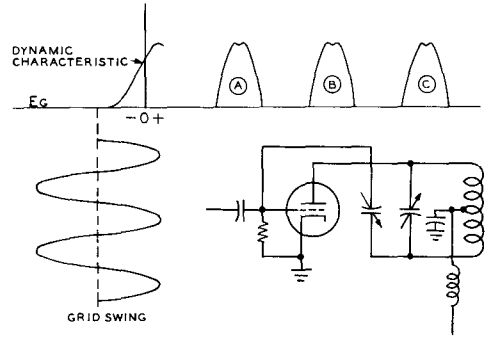

Figure 21
CLASS C AMPLIFIER OPERATION

Plate current pulses are shown at (A), (B), and (C). The dip in the top of the plate current waveform will occur when the excitation voltage is such that the minimum plate voltage dips below the maximum grid voltage. A detailed discussion of the operation of Class C amplifiers is given in Chapter Seven.

$$Q = \frac{R_L}{X_C} = \frac{R_L}{X_L}$$

where R_L is the resonant impedance of the tank and X_C is the reactance of the tank capacitor and X_L is the reactance of the tank coil. This value of resonant impedance, R_L , is the load which is presented to the Class C amplifier tube in a single-ended circuit such as shown in figure 21.

The value of load impedance, R_L , which the Class C amplifier tube sees may be obtained, looking in the other direction from the tank coil, from a knowledge of the operating conditions on the Class C tube. This load impedance may be obtained from the following expression, which is true in the general case of any Class C amplifier:

$$R_L = \frac{E_{pm}^2}{2 N_p I_b E_{bb}}$$

where the values in the equation have the characteristics listed in the beginning of Chapter 6.

The expression above is academic, since the peak value of the fundamental component of plate voltage swing, E_{pm} , is not ordinarily known unless a high-voltage peak-a-c voltmeter is available for checking. Also, the decimal value of plate circuit efficiency is not ordinarily known with any degree of accuracy. However, in a *normally operated* Class C amplifier

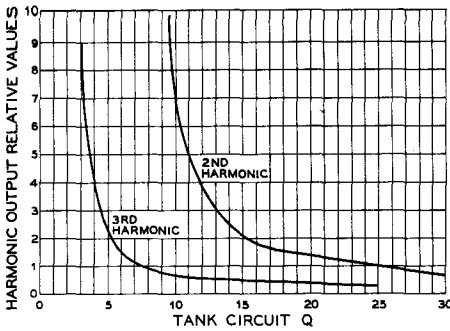

Figure 22
RELATIVE HARMONIC OUTPUT
PLOTTED AGAINST TANK CIRCUIT Q

the plate voltage swing will be approximately equal to 0.85 to 0.9 times the d-c plate voltage on the stage, and the plate circuit efficiency will be from 70 to 80 per cent (N_p of 0.7 to 0.8), the higher values of efficiency normally being associated with the higher values of plate voltage swing. With these two assumptions as to the normal Class C amplifier, the expression for the plate load impedance can be greatly simplified to the following approximate but useful expression:

$$R_L \approx \frac{R_{d.c.}}{2}$$

which means simply that the resistance presented by the tank circuit to the Class C tube is approximately equal to one-half the d-c load resistance which the Class C stage presents to the power supply (and also to the modulator in case high-level modulation of the stage is to be used).

Combining the above simplified expression for the r-f impedance presented by the tank to the tube, with the expression for tank Q given in a previous paragraph we have the following expression which relates the reactance of the tank capacitor or coil to the d-c input to the Class C stage:

$$X_C = X_L \approx \frac{R_{d.c.}}{2Q}$$

The above expression is the basis of the usual charts giving tank capacitance for the various bands in terms of the d-c plate voltage and current to the Class C stage, including the charts of figure 23, figure 24 and figure 25.

Harmonic Radiation vs. Q

The problem of harmonic radiation from transmitters has long been present, but it has become critical only relatively recently along with the extensive occupation of the v-h-f range. Television signals are particularly susceptible to interference from other signals falling within the pass band of the receiver, so that the TVI problem has received the major emphasis of all the services in the v-h-f range which are susceptible to interference from harmonics of signals in the h-f or lower v-h-f range.

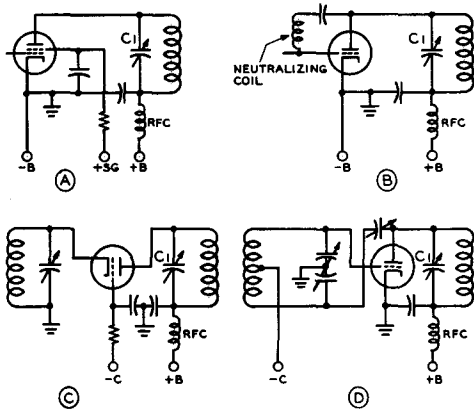
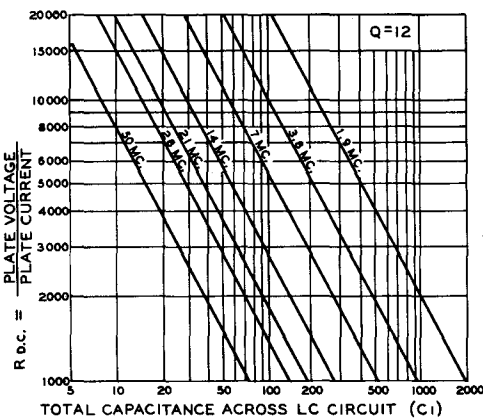

Figure 23
PLATE-TANK CIRCUIT ARRANGEMENTS

Shown above in the case of each of the tank circuit types is the recommended tank circuit capacitance. (A) is a conventional tetrode amplifier, (B) is a coil-neutralized triode amplifier, (C) is a grounded-grid triode amplifier, (D) is a grid-neutralized triode amplifier.

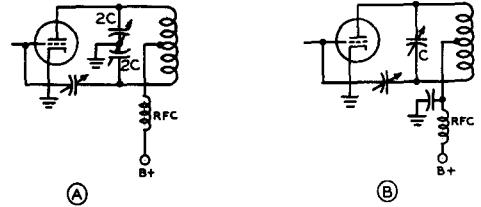
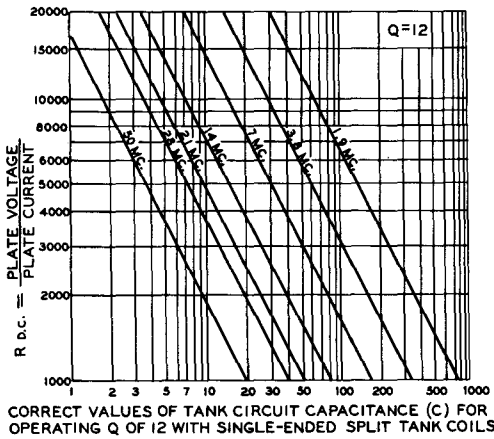

Figure 24
 PLATE-TANK CIRCUIT ARRANGEMENTS

Shown above for each of the tank circuit types is the recommended tank circuit capacitance at the operating frequency for an operating Q of 12. (A) is a split-stator tank, each section of which is twice the capacity value read on the graph. (B) is circuit using tapped coil for phase reversal.

Inspection of figure 22 will show quickly that the tank circuit of a Class C amplifier should have an operating Q of 12 or greater to afford satisfactory rejection of second harmonic energy. The curve begins to straighten out above a Q of about 15, so that a considerable increase in Q must be made before an appreciable reduction in second-harmonic energy is obtained. Above a circuit Q of about 10 any increase will not afford appreciable reduction in the third-harmonic energy, so that additional harmonic filtering circuits external to the amplifier proper must be used if increased attenuation of higher order harmonics is desired. The curves also show that push-pull amplifiers may be operated at Q values of 6 or so, since the second harmonic is cancelled to a large extent if there is no unbalanced coupling between the output tank circuit and the antenna system.

Capacity Charts for Correct Tank Q

Figures 23, 24 and 25 illustrate the correct value of tank capacity for various circuit configurations. A Q value of 12 has been chosen as optimum for single ended circuits, and a value of 6 has been chosen for push-pull circuits. Figure 23 is used when a single ended stage is employed, and the capacitance values given are for the total capacitance across the tank coil. This value includes the tube interelectrode capacitance (plate to ground), coil distributed capacitance, wiring capacities, and the value of any low-

inductance plate-to-ground by-pass capacitor as used for reducing harmonic generation, in addition to the actual "in-use" capacitance of the plate tuning capacitor. Total circuit stray capacitance may vary from perhaps 5 micromicrofarads for a v-h-f stage to 30 micromicrofarads for a medium power tetrode h-f stage.

When a split plate tank coil is employed in the stage in question, the graph of figure 24 should be used. The capacity read from the graph is the total capacity across the tank coil. If the split-stator tuning capacitor is used, each section of the capacitor should have a value of capacity equal to *twice* the value indicated by the graph. As in the case of figure 23, the values of capacity read on the graph of figure 24 include all residual circuit capacities.

For push-pull operation, the correct values of tank circuit capacity may be determined with the aid of figure 25. The capacity values obtained from figure 25 are the effective values across the tank circuit, and if a split-stator tuning capacitor is used, each section of the capacitor should have a value of capacity equal to *twice* the value indicated by the graph. As in the case of figures 23 and 24, the values of capacity read on the graph of figure 25 include all residual circuit capacities.

The tank circuit operates in the same manner whether the tube feeding it is a pentode, beam tetrode, neutralized triode, grounded-grid triode, whether it is single ended or push-

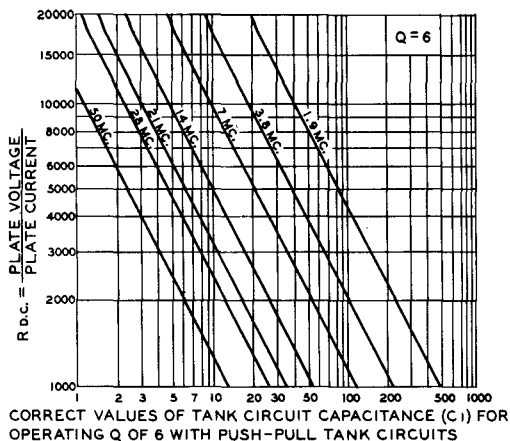
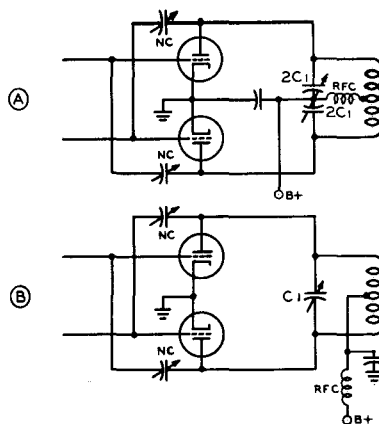

Figure 25

PLATE-TANK CIRCUIT ARRANGEMENTS FOR PUSH-PULL STAGES

Shown above is recommended tank circuit capacity at operating frequency for a Q of 6. (A) is split-stator tank, each section of which is twice the capacity value read on the graph. (B) is circuit using tapped coil for phase reversal.



pull, or whether it is shunt fed or series fed. The important thing in establishing the operating Q of the tank circuit is the ratio of the loaded resonant impedance across its terminals to the reactance of the L and the C which make up the tank.

Due to the unknowns involved in determining circuit stray capacitances it is sometimes more convenient to determine the value of L required for the proper circuit Q (by the method discussed earlier in this Section) and then to vary the tuned circuit capacitance until resonance is reached. This method is most frequently used in obtaining proper circuit Q in commercial transmitters.

The values of R_p for using the charts are easily calculated by dividing the d-c plate supply voltage by the total d-c plate current (expressed in amperes). Correct values of total tuning capacitance are shown in the chart for the different amateur bands. The shunt stray capacitance can be estimated closely enough for all practical purposes. The coil inductance should then be chosen which will produce resonance at the desired frequency with the total calculated tuning capacitance.

Effect of Loading on Q The Q of a circuit depends upon the resistance in series with the capacitance and inductance.

This series resistance is very low for a low-loss coil not loaded by an antenna circuit. The value of Q may be from 100 to 600 under these conditions. Coupling an antenna

circuit has the effect of increasing the series resistance, though in this case the power is consumed as useful radiation by the antenna. Mathematically, the antenna increases the value of R in the expression $Q = \omega L/R$ where L is the coil inductance in microhenrys and ω is the term $2\pi f$, f being in megacycles.

The coupling from the final tank circuit to the antenna or antenna transmission line can be varied to obtain values of Q from perhaps 3 at maximum coupling to a value of Q equal to the unloaded Q of the circuit at zero antenna coupling. This value of unloaded Q can be as high as 500 or 600, as mentioned in the preceding paragraph. However, the value of $Q = 12$ will not be obtained at values of normal d-c plate current in the Class C amplifier stage unless the C-to-L ratio in the tank circuit is correct for that frequency of operation.

Tuning Capacitor Air Gap To determine the required tuning capacitor air gap for a particular amplifier circuit it is first necessary to estimate the peak r-f voltage which will appear between the plates of the tuning capacitor. Then, using figure 26, it is possible to estimate the plate spacing which will be required.

The instantaneous r-f voltage in the plate circuit of a Class C amplifier tube varies from nearly zero to nearly twice the d-c plate voltage. If the d-c voltage is being 100 per cent modulated by an audio voltage, the r-f peaks will reach nearly four times the d-c voltage.

The instantaneous r-f voltage in the plate circuit of a Class C amplifier tube varies from nearly zero to nearly twice the d-c plate voltage. If the d-c voltage is being 100 per cent modulated by an audio voltage, the r-f peaks will reach nearly four times the d-c voltage.

FIGURE 26

USUAL BREAKDOWN RATINGS OF COMMON PLATE SPACINGS	
Air-gap in inches	Peak voltage breakdown
.030	1,000
.050	2,000
.070	3,000
.100	4,000
.125	4,500
.150	5,200
.170	6,000
.200	7,500
.250	9,000
.350	11,000
.500	15,000
.700	20,000

Recommended air-gap for use when no d-c voltage appears across plate tank condenser (when plate circuit is shunt fed, or when the plate tank condenser is insulated from ground).

D.C. PLATE VOLTAGE	C.W.	PLATE MOD.
400	.030	.050
600	.050	.070
750	.050	.084
1000	.070	.100
1250	.070	.144
1500	.078	.200
2000	.100	.250
2500	.175	.375
3000	.200	.500
3500	.250	.600

Spacings should be multiplied by 1.5 for same safety factor when d-c voltage appears across plate tank condenser.

These rules apply to a loaded amplifier or buffer stage. If either is operated without an r-f load, the peak voltages will be greater and can exceed the d-c plate supply voltage. For this reason no amplifier should be operated without load when anywhere near normal d-c plate voltage is applied.

If a plate blocking condenser is used, it must be rated to withstand the d-c plate voltage plus any audio voltage. This capacitor should be rated at a d-c working voltage of at least twice the d-c plate supply in a plate modulated amplifier, and at least equal to the d-c supply in any other type of r-f amplifier.

13-10 L and Pi Matching Networks

The L and pi networks often can be put to advantageous use in accomplishing an impedance match between two differing impedances. Common applications are the matching between a transmission line and an antenna, or between the plate circuit of a single-ended amplifier stage and an antenna transmission line. Such networks may be used to accomplish a match

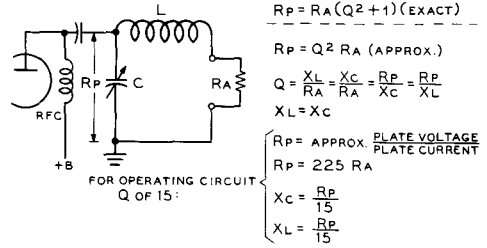

Figure 27 THE L NETWORK IMPEDANCE TRANSFORMER

The L network is useful with a moderate operating Q for high values of impedance transformation, and it may be used for applications other than in the plate circuit of a tube with relatively low values of operating Q for moderate impedance transformations. Exact and approximate design equations are given.

between the plate tank circuit of an amplifier and a transmission line, or they may be used to match directly from the plate circuit of an amplifier to the line without the requirement for a tank circuit—provided the network is designed in such a manner that it has sufficient operating Q for accomplishing harmonic attenuation.

The L Matching Network The L network is of limited utility in impedance matching since its ratio of impedance transformation is fixed at a value equal to (Q^2+1) . The operating Q may be relatively low (perhaps 3 to 6) in a matching network between the plate tank circuit of an amplifier and a transmission line; hence impedance transformation ratios of 10 to 1 and even lower may be attained. But when the network also acts as the plate tank circuit of the amplifier stage, as in figure 27, the operating Q should be at least 12 and preferably 15. An operating Q of 15 represents an impedance transformation of 225; this value normally will be too high even for transforming from the 2000 to 10,000 ohm plate impedance of a Class C amplifier stage down to a 50-ohm transmission line.

However, the L network is interesting since it forms the basis of design for the pi network. Inspection of figure 27 will show that the L network in reality must be considered as a parallel-resonant tank circuit in which R_A represents the coupled-in load resistance; only in this case the load resistance is directly coupled into the tank circuit rather than being inductively coupled as in the conven-

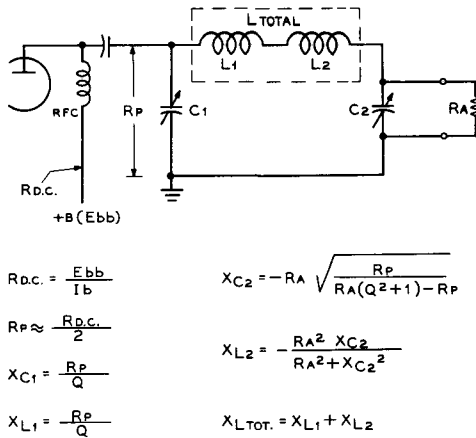

Figure 28
THE PI NETWORK

The pi network is valuable for use as an impedance transformer over a wide ratio of transformation values. The operating Q should be at least 12 and preferably 15 to 20 when the circuit is to be used in the plate circuit of a Class C amplifier. Design equations are given above. The inductor L_{TOT} represents a single inductance, usually variable, with a value equal to the sum of L_1 and L_2 .

tional arrangement where the load circuit is coupled to the tank circuit by means of a link. When R_A is shorted, L and C comprise a conventional parallel-resonant tank circuit, since for proper operation L and C must be resonant in order for the network to present a resistive load to the Class C amplifier.

The Pi Network The pi impedance matching network, illustrated in figure 28, is much more general in its application than the L network since it offers greater harmonic attenuation, and since it can be used to match a relatively wide range of impedances while still maintaining any desired operating Q. The values of C_1 and L_1 in the pi network of figure 28 can be thought of as having the same values of the L network in figure 27 for the same operating Q, but what is more important from the comparison standpoint these values will be the same as in a conventional tank circuit.

The value of the capacitance may be determined by calculation, with the operating Q and the load impedance which should be reflected to the plate of the Class C amplifier as the two knowns—or the actual values of the ca-

pacitance may be obtained for an operating Q of 12 by reference to figures 23, 24 and 25.

The inductive arm in the pi network can be thought of as consisting of two inductances in series, as illustrated in figure 28. The first portion of this inductance, L_1 , is that value of inductance which would resonate with C_1 at the operating frequency—the same as in a conventional tank circuit. However, the actual value of inductance in this arm of the pi network, L_{TOT} will be greater than L_1 for normal values of impedance transformation. For high transformation ratios L_{TOT} will be only slightly greater than L_1 ; for a transformation ratio of 1.0, L_{TOT} will be twice as great as L_1 . The amount of inductance which must be added to L_1 to restore resonance and maintain circuit Q is obtained through use of the expression for $X_{L1,2}$ in figure 28.

The peak voltage rating of the main tuning capacitor C_1 should be the normal value for a Class C amplifier operating at the plate voltage to be employed. The inductor L_{TOT} may be a plug-in coil which is changed for each band of operation, or some sort of variable inductor may be used. A continuously variable slider-type of variable inductor, such as used in certain items of surplus military equipment, may be used to good advantage if available, or a tapped inductor such as used in the ART-13 may be employed. However, to maintain good circuit Q on the higher frequencies when a variable or tapped coil is used on the lower frequencies, the tapped or variable coil should be removed from the circuit and replaced by a smaller coil which has been especially designed for the higher frequency ranges.

The peak voltage rating of the output or loading capacitor, C_2 , is determined by the power level and the impedance to be fed. If a 50-ohm coaxial line is to be fed from the pi network, receiving-type capacitors will be satisfactory even up to the power level of a plate-modulated kilowatt amplifier. In any event, the peak voltage which will be impressed across the output capacitor is expressed by: $E_{pk}^2 = 2 R_A W_o$, where E_{pk} is the peak voltage across the capacitor, R_A is the value of resistive load which the network is feeding, and W_o is the maximum value of the average power output of the stage. The harmonic attenuation of the pi network is quite good, although an external low-pass filter will be required to obtain harmonic attenuation value upward of 100 db such as normally required. The attenuation to second harmonic energy will be approximately 40 db for an operating Q of 15 for the pi network; the value increases to about 45 db for a 1:1 transformation and falls to about 38 db for an impedance step-down of 80:1, assuming that the operating Q is maintained at 15.

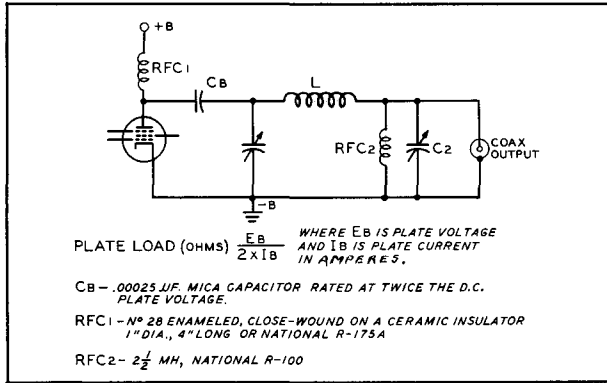

Estimated Plate Load (ohms)	1,000	1,500	2,000	2,500	3,000	3,500	4,000	4,500	5,000	6,000*	NOTES
C_1 in μ mf, 3.5 Mc	520	360	280	210	180	155	135	120	110	90	The actual capacitance setting for C_1 equals the value in this table minus the published tube output capacitance. Air gap approx. 10 mils/100 v E_b .
7	260	180	140	105	90	76	68	60	56	45	
14	130	90	70	52	45	38	34	30	28	23	
21	85	60	47	35	31	25	23	20	19	15	
28	65	45	35	26	23	19	17	15	14	11	
L in μ h, 3.5 Mc	4.5	6.5	8.5	10.5	12.5	14	15.5	18	20	25	Inductance values are for a 50-ohm load. For a 70-ohm load, values are approx. 3% higher.
7	2.2	3.2	4.2	5.2	6.2	7	7.8	9	10	12.5	
14	1.1	1.6	2.1	2.6	3.1	3.5	3.9	4.5	5	6.2	
21	0.73	1.08	1.38	1.7	2.05	2.3	2.6	3	3.3	4.1	
28	0.55	0.8	1.05	1.28	1.55	1.7	1.95	2.25	2.5	3.1	
C_2 in μ mf, 3.5 Mc	2,400	2,100	1,800	1,550	1,400	1,250	1,100	1,000	900	700	For 50-ohm transmission line. 350 Air gap for C_2 is approx. 1 mil/100 v E_b .
7	1,200	1,060	900	760	700	630	560	500	460	350	
14	600	530	450	380	350	320	280	250	230	175	
21	400	350	300	250	230	210	185	165	155	120	
28	300	265	225	190	175	160	140	125	115	90	
C_2 in μ mf, 3.5 Mc	1,800	1,500	1,300	1,100	1,000	900	800	720	640	500	For 70-ohm transmission line.
7	900	750	650	560	500	450	400	360	320	250	
14	450	370	320	280	250	220	200	180	160	125	
21	300	250	215	190	170	145	130	120	110	85	
28	225	185	160	140	125	110	100	90	80	65	

* Values given are approximations. All components shown in Table I are for a Q of 12. For other values of Q, use $\frac{Q_k}{Q_{11}} = \frac{C_k}{C_1}$ and $\frac{Q_k}{Q_{11}} = \frac{L_k}{L_1}$. When the estimated plate load is higher than 5,000 ohms, it is recommended that the components be selected for a circuit Q between 20 and 30.

Table I Components for Pi-Coupled Final Amplifiers

Component Chart for Pi-Networks To simplify design procedure, a pi-network chart, compiled by M. Seybold, W2RYI (reproduced by courtesy of R.C.A. Tube Division, Harrison, N.J.) is shown in table I. This chart summarizes the calculations of figure 28 for various values of plate load.

13-11 Grid Bias

Radio-frequency amplifiers require some form of *grid bias* for proper operation. Practically all r-f amplifiers operate in such a manner that plate current flows in the form of short pulses which have a duration of only a fraction of an r-f cycle. To accomplish this

with a sinusoidal excitation voltage, the operating grid bias must be at least sufficient to cut off the plate current. In very high efficiency Class C amplifiers the operating bias may be many times the cutoff value. Cutoff bias, it will be recalled, is that value of grid voltage which will reduce the plate current to zero at the plate voltage employed. The method for calculating it has been indicated previously. This theoretical value of cutoff will not reduce the plate current completely to zero, due to the variable- μ tendency or "knee" which is characteristic of all tubes as the cutoff point is approached.

Class C Bias Amplitude modulated Class C amplifiers should be operated with the grid bias adjusted to a value greater than twice cutoff at the operating plate volt-

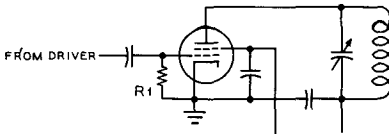

Figure 29
GRID-LEAK BIAS

The grid leak on an amplifier or multiplier stage may also be used as the shunt feed impedance to the grid of the tube when a high value of grid leak (greater than perhaps 20,000 ohms) is used. When a lower value of grid leak is to be employed, an r-f choke should be used between the grid of the tube and the grid leak to reduce r-f losses in the grid leak resistance.

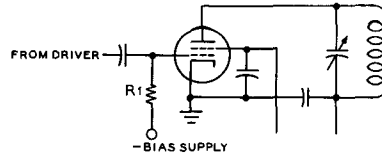

Figure 30
COMBINATION GRID-LEAK AND
FIXED BIAS

Grid-leak bias often is used in conjunction with a fixed minimum value of power supply bias. This arrangement permits the operating bias to be established by the excitation energy, but in the absence of excitation the electrode currents to the tube will be held to safe values by the fixed-minimum power supply bias. If a relatively low value of grid leak is to be used, an r-f choke should be connected between the grid of the tube and the grid leak as discussed in figure 29.

age. This procedure will insure that the tube is operating at a bias greater than cutoff when the plate voltage is doubled on positive modulation peaks. C-w telegraph and FM transmitters can be operated with bias as low as cutoff, if only limited excitation is available and moderate plate efficiency is satisfactory. In a c-w transmitter, the bias supply or resistor should be adjusted to the point which will allow normal grid current to flow for the particular amount of grid driving r-f power available. This form of adjustment will allow more output from the under-excited r-f amplifier than when higher bias is used with corresponding lower values of grid current. In any event, the operating bias should be set at as low a value as will give satisfactory operation, since harmonic generation in a stage increases rapidly as the bias is increased.

Grid-Leak Bias A resistor can be connected in the grid circuit of a Class C amplifier to provide grid-leak bias. This resistor, R_1 in figure 29, is part of the d-c path in the grid circuit.

The r-f excitation applied to the grid circuit of the tube causes a pulsating direct current to flow through the bias supply lead, due to the rectifying action of the grid, and any current flowing through R_1 produces a voltage drop across that resistor. The grid of the tube is positive for a short duration of each r-f cycle, and draws electrons from the filament or cathode of the tube during that time. These electrons complete the circuit through the d-c grid return. The voltage drop across the resistance in the grid return provides a *negative bias* for the grid.

Grid-leak bias automatically adjusts itself over fairly wide variations of r-f excitation. The value of grid-leak resistance should be such that normal values of grid current will flow at the maximum available amount of r-f

excitation. Grid-leak bias cannot be used for grid-modulated or linear amplifiers in which the average d-c grid current is constantly varying with modulation.

Safety Bias Grid-leak bias alone provides no protection against excessive plate current in case of failure of the source of r-f grid excitation. A C-battery or C-bias supply can be connected in series with the grid leak, as shown in figure 30. This fixed protective bias will protect the tube in the event of failure of grid excitation. "Zero-bias" tubes do not require this bias source in addition to the grid leak, since their plate current will drop to a safe value when the excitation is removed.

Cathode Bias A resistor can be connected in series with the cathode or center-tapped filament lead of an amplifier to secure *automatic bias*. The plate current flows through this resistor, then back to the cathode or filament, and the voltage drop across the resistor can be applied to the grid circuit by connecting the grid bias lead to the grounded or power supply end of the resistor R , as shown in figure 31.

The grounded (B-minus) end of the cathode resistor is negative relative to the cathode by an amount equal to the voltage drop across the resistor. The value of resistance must be so chosen that the sum of the desired grid and plate current flowing through the resistor will bias the tube for proper operation.

This type of bias is used more extensively in audio-frequency than in radio-frequency amplifiers. The voltage drop across the resistor

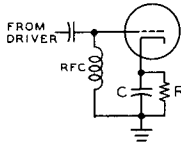

Figure 31

R-F STAGE WITH CATHODE BIAS

Cathode bias sometimes is advantageous for use in an r-f stage that operates with a relatively small amount of r-f excitation.

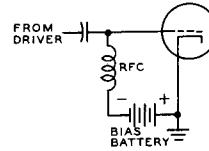

Figure 32

R-F STAGE WITH BATTERY BIAS

Battery bias is seldom used, due to deterioration of the cells by the reverse grid current. However, it may be used in certain special applications, or the fixed bias voltage may be supplied by a bias power supply.

must be subtracted from the total plate supply voltage when calculating the power input to the amplifier, and this loss of plate voltage in an r-f amplifier may be excessive. A Class A audio amplifier is biased only to approximately one-half cutoff, whereas an r-f amplifier may be biased to twice cutoff, or more, and thus the plate supply voltage loss may be a large percentage of the total available voltage when using low or medium μ tubes.

Oftentimes just enough cathode bias is employed in an r-f amplifier to act as safety bias to protect the tubes in case of excitation failure, with the rest of the bias coming from a grid leak.

Separate Bias Supply An external supply often is used for grid bias, as shown in figure 32. Battery bias gives very good voltage regulation and is satisfactory for grid-modulated or linear amplifiers, which operate at low grid current. In the case of Class C amplifiers which operate with high grid current, battery bias is not satisfactory. This direct current has a charging effect on the dry batteries; after a few months of service the cells will become unstable, bloated, and noisy.

A separate a-c operated power supply is commonly used for grid bias. The bleeder resistance across the output of the filter can be made sufficiently low in value that the grid current of the amplifier will not appreciably change the amount of negative grid-bias voltage. Alternately, a voltage regulated grid-bias supply can be used. This type of bias supply is used in Class B audio and Class B r-f linear amplifier service where the voltage regulation in the C-bias supply is important. For a Class C amplifier, regulation is not so important, and an economical design of components in the power supply, therefore, can be utilized. In this case, the bias voltage must be adjusted with normal grid current flowing, as the grid current will raise the bias con-

siderably when it is flowing through the bias-supply bleeder resistance.

13-12 Protective Circuits for Tetrode Transmitting Tubes

The tetrode transmitting tube requires three operating voltages: grid bias, screen voltage, and plate voltage. The current requirements of these three operating voltages are somewhat interdependent, and a change in potential of one voltage will affect the current drain of the tetrode in respect to the other two voltages. In particular, if the grid excitation voltage is interrupted as by keying action, or if the plate supply is momentarily interrupted, the resulting voltage or current surges in the screen circuit are apt to permanently damage the tube.

The Series Screen Supply A simple method of obtaining screen voltage is by means of a dropping resistor from the high voltage plate supply, as shown in figure 33. Since the current drawn by the screen is a function of the exciting voltage applied to the tetrode, the screen voltage will rise to equal the plate voltage under conditions of no exciting voltage. If the control grid is overdriven, on the other hand, the screen current may become excessive. In either case, damage to the screen and its associated components may result. In addition, fluctuations in the plate loading of the tetrode stage will cause changes in the screen current of the tube. This will result in screen voltage fluctuations due to the inherently poor voltage regulation of the screen series dropping resistor. These effects become dangerous to tube life if the plate voltage is greater than the screen voltage by a factor of 2 or so.

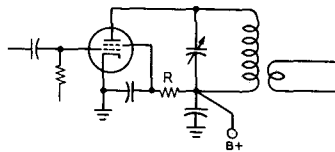

Figure 33
DROPPING-RESISTOR SCREEN SUPPLY

The Clamp Tube A clamp tube may be added to the series screen supply, as shown in figure 34. The clamp tube is normally cut off by virtue of the d-c grid bias developed across the grid resistor of the tetrode tube. When excitation is removed from the tetrode, no bias appears across the grid resistor, and the clamp tube conducts heavily, dropping the screen voltage to a safe value. When excitation is applied to the tetrode the clamp tube is inoperative, and fluctuations of the plate loading of the tetrode tube could allow the screen voltage to rise to a damaging value. Because of this factor, the clamp tube does not offer complete protection to the tetrode.

The Separate Screen Supply A low voltage screen supply may be used instead of the series screen dropping resistor. This will protect the screen circuit from excessive voltages when the other tetrode operating parameters shift. However, the screen can be easily damaged if plate or bias voltage is removed from the tetrode, as the screen current will reach high values and the screen dissipation will be exceeded. If the screen supply is capable of providing slightly more screen voltage than the tetrode requires for proper operation, a series wattage-limiting resistor may be added to the circuit as shown in figure 35. With this resistor in the circuit it is possible to apply excitation to the tetrode tube with screen voltage present (but in the absence of plate voltage) and still not damage the screen of the tube. The value of the resistor should be chosen so that the product of the voltage applied to the screen of the tetrode times the screen current never exceeds the maximum rated screen dissipation of the tube.

13-13 Interstage Coupling

Energy is usually coupled from one circuit of a transmitter into another either by *capacitive coupling*, *inductive coupling*, or *link cou-*

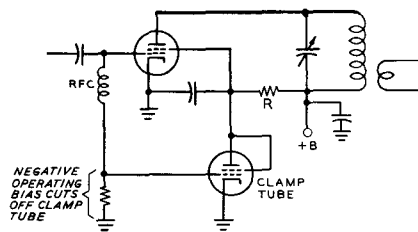

Figure 34
CLAMP-TUBE SCREEN SUPPLY

pling. The latter is a special form of inductive coupling. The choice of a coupling method depends upon the purpose for which it is to be used.

Capacitive Coupling Capacitive coupling between an amplifier or doubler circuit and a preceding driver stage is shown in figure 36. The coupling capacitor, C, isolates the d-c plate supply from the next grid and provides a low impedance path for the r-f energy between the tube being driven and the driver tube. This method of coupling is simple and economical for low power amplifier or exciter stages, but has certain disadvantages, particularly for high frequency stages. The grid leads in an amplifier should be as short as possible, but this is difficult to attain in the physical arrangement of a high power amplifier with respect to a capacitively-coupled driver stage.

Disadvantages of Capacitive Coupling One significant disadvantage of capacitive coupling is the difficulty of adjusting the load on the driver stage. Impedance adjustment can be accomplished by tapping the coupling lead a part of the way down on the plate coil of the tuned stage of the driver circuit; but often when this is done

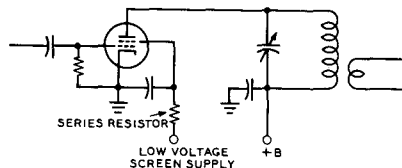

Figure 35
A PROTECTIVE WATTAGE-LIMITING RESISTOR FOR USE WITH LOW-VOLTAGE SCREEN SUPPLY

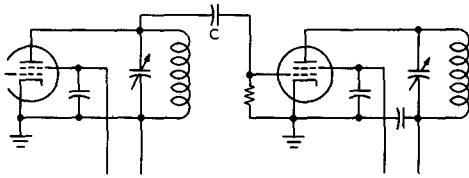

Figure 36
CAPACITIVE INTERSTAGE COUPLING

a parasitic oscillation will take place in the stage being driven.

One main disadvantage of capacitive coupling lies in the fact that the grid-to-filament capacitance of the driven tube is placed directly across the driver tuned circuit. This condition sometimes makes the r-f amplifier difficult to neutralize, and the increased minimum circuit capacitance makes it difficult to use a reasonable size coil in the v-h-f range. Difficulties from this source can be partially eliminated by using a center-tapped or split-stator tank circuit in the plate of the driver stage, and coupling capacitively to the opposite end from the plate. This method places the plate-to-filament capacitance of the driver across one-half of the tank and the grid-to-filament capacitance of the following stage across the other half. This type of coupling is shown in figure 37.

Capacitive coupling can be used to advantage in reducing the total number of tuned circuits in a transmitter so as to conserve space and cost. It also can be used to advantage between stages for driving beam tetrode or pentode amplifier or doubler stages.

Inductive Coupling *Inductive coupling* (figure 38) results when two coils are electromagnetically coupled to one another. The degree of coupling is controlled by varying the mutual inductance of the two coils, which is accomplished by changing the spacing or the relationship between the axes of the coils.

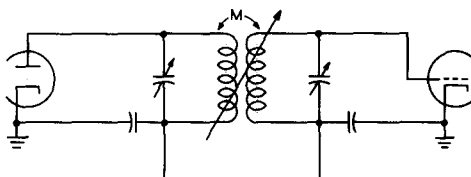

Figure 38
INDUCTIVE INTERSTAGE COUPLING

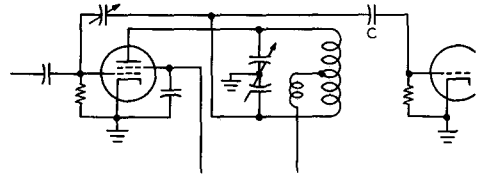

Figure 37
BALANCED CAPACITIVE COUPLING

Balanced capacitive coupling sometimes is useful when it is desirable to use a relatively large inductance in the interstage tank circuit, or where the exciting stage is neutralized as shown above.

Inductive coupling is used extensively for coupling r-f amplifiers in radio receivers. However, the mechanical problems involved in adjusting the degree of coupling limit the usefulness of direct inductive coupling in transmitters. Either the primary or the secondary or both coils may be tuned.

Unity Coupling If the grid tuning capacitor of figure 38 is removed and the coupling increased to the maximum practicable value by interwinding the turns of the two coils, the circuit insofar as r.f. is concerned acts like that of figure 36, in which one tank serves both as plate tank for the driver and grid tank for the driven stage. The inter-wound grid winding serves simply to isolate the d-c plate voltage of the driver from the grid of the driven stage, and to provide a return for d-c grid current. This type of coupling, illustrated in figure 39, is commonly known as *unity coupling*.

Because of the high mutual inductance, both primary and secondary are resonated by the one tuning capacitor.

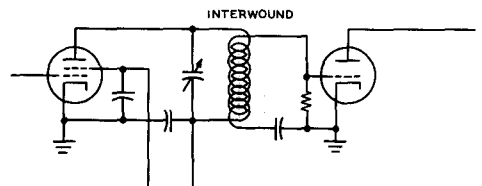

Figure 39
"UNITY" INDUCTIVE COUPLING

Due to the high value of coupling between the two coils, one tuning capacitor tunes both circuits. This arrangement often is useful in coupling from a single-ended to a push-pull stage.

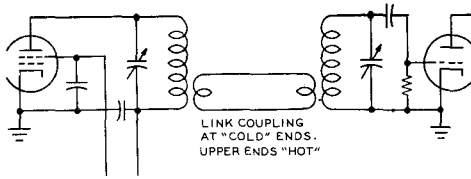

Figure 40
INTERSTAGE COUPLING BY MEANS
OF A "LINK"

Link interstage coupling is very commonly used since the two stages may be separated by a considerable distance, since the amount of a coupling between the two stages may be easily varied, and since the capacitances of the two stages may be isolated to permit use of larger inductances in the v-h-f range.

Link Coupling A special form of inductive coupling which is widely employed in radio transmitter circuits is known as *link coupling*. A low impedance r-f transmission line couples the two tuned circuits together. Each end of the line is terminated in one or more turns of wire, or links, wound around the coils which are being coupled together. These links should be coupled to each tuned circuit at the point of zero r-f potential, or *nodal point*. A ground connection to one side of the link usually is used to reduce harmonic coupling, or where capacitive coupling between two circuits must be minimized. Coaxial line is commonly used to transfer energy between the two coupling links, although Twin-Lead may be used where harmonic attenuation is not so important.

Typical link coupled circuits are shown in figures 40 and 41. Some of the advantages of link coupling are the following:

- (1) It eliminates coupling taps on tuned circuits.
- (2) It permits the use of series power supply connections in both tuned grid and tuned plate circuits, and thereby eliminates the need of shunt-feed r-f chokes.
- (3) It allows considerable separation between transmitter stages without appreciable r-f losses or stray chassis currents.
- (4) It reduces capacitive coupling and thereby makes neutralization more easily attainable in r-f amplifiers.
- (5) It provides semi-automatic impedance matching between plate and grid tuned circuits, with the result that greater grid drive can be obtained in comparison to capacitive coupling.
- (6) It effectively reduces the coupling of harmonic energy.

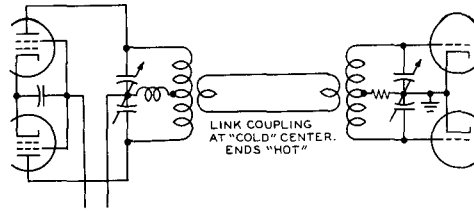

Figure 41
PUSH-PULL LINK COUPLING

The link-coupling line and links can be made of no. 18 push-back wire for coupling between low-power stages. For coupling between higher powered stages the 150-ohm Twin-Lead transmission line is quite effective and has very low loss. Coaxial transmission is most satisfactory between high powered amplifier stages, and should always be used where harmonic attenuation is important.

13-14 Radio-Frequency Chokes

Radio-frequency chokes are connected in circuits for the purpose of stopping the passage of r-f energy while still permitting a direct current or audio-frequency current to pass. They consist of inductances wound with a large number of turns, either in the form of a solenoid, a series of solenoids, a single universal pie winding, or a series of pie windings. These inductors are designed to have as much inductance and as little distributed or shunt capacitance as possible. The unavoidable small amount of distributed capacitance resonates the inductance, and this frequency normally should be much lower than the frequency at which the transmitter or receiver circuit is operating. R-f chokes for operation on several bands must be designed carefully so that the impedance of the choke will be extremely high (several hundred thousand ohms) in each of the bands.

The direct current which flows through the r-f choke largely determines the size of wire to be used in the winding. The inductance of r-f chokes for the v-h-f range is much less than for chokes designed for broadcast and ordinary short-wave operation. A very high inductance r-f choke has more distributed capacitance than a smaller one, with the result

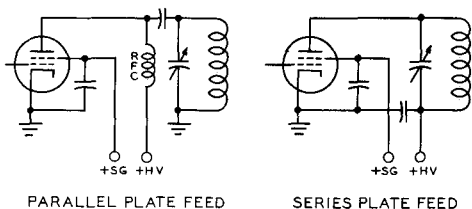

PARALLEL PLATE FEED

SERIES PLATE FEED

Figure 42

ILLUSTRATING PARALLEL AND SERIES PLATE FEED

Parallel plate feed is desirable from a safety standpoint since the tank circuit is at ground potential with respect to d.c. However, a high-impedance r-f choke is required, and the r-f choke must be able to withstand the peak r-f voltage output of the tube. Series plate feed eliminates the requirement for a high-performance r-f choke, but requires the use of a relatively large value of by-pass capacitance at the bottom end of the tank circuit, as contrasted to the moderate value of coupling capacitance which may be used at the top of the tank circuit for parallel plate feed.

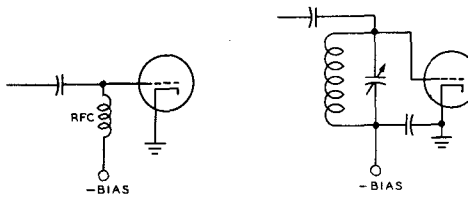

PARALLEL BIAS FEED

SERIES BIAS FEED

Figure 43

ILLUSTRATING SERIES AND PARALLEL BIAS FEED

13-15 Parallel and Push-Pull Tube Circuits

The comparative r-f power output from parallel or push-pull operated amplifiers is the same if proper impedance matching is accomplished, if sufficient grid excitation is available in both cases, and if the frequency of measurement is considerably lower than the frequency limit of the tubes.

that it will actually offer less impedance at very high frequencies.

Another consideration, just as important as the amount of d.c. the winding will carry, is the r-f voltage which may be placed across the choke without its breaking down. This is a function of insulation, turn spacing, frequency, number and spacing of pies and other factors.

Some chokes which are designed to have a high impedance over a very wide range of frequency are, in effect, really two chokes: a u-h-f choke in series with a high-frequency choke. A choke of this type is polarized; that is, it is important that the correct end of the combination choke be connected to the "hot" side of the circuit.

Shunt and Series Feed Direct-current grid and plate connections are made either by series or parallel feed systems.

Simplified forms of each are shown in figures 42 and 43.

Series feed can be defined as that in which the d-c connection is made to the grid or plate circuits at a point of very low r-f potential. Shunt feed always is made to a point of high r-f voltage and always requires a high impedance r-f choke or a relatively high resistance to prevent waste of r-f power.

Parallel Operation Operating tubes in parallel has some advantages in transmitters designed for operation below 10 Mc., particularly when tetrode or pentode tubes are to be used. Only one neutralizing capacitor is required for parallel operation of triode tubes, as against two for push-pull. Above about 10 Mc., depending upon the tube type, parallel tube operation is not ordinarily recommended with triode tubes. However, parallel operation of grounded-grid stages and stages using low-C beam tetrodes often will give excellent results well into the v-h-f range.

Push-Pull Operation The push-pull connection provides a well-balanced circuit insofar as miscellaneous capacitances are concerned; in addition, the circuit can be neutralized more completely, especially in high-frequency amplifiers. The L/C ratio in a push-pull amplifier can be made higher than in a plate-neutralized parallel-tube operated amplifier. Push-pull amplifiers, when perfectly balanced, have less second-harmonic output than parallel or single-tube amplifiers, but in practice undesired capacitive coupling and circuit unbalance more or less offset the theoretical harmonic-reducing advantages of push-pull r-f circuits.

R-F Feedback

Comparatively high gain is required in single sideband equipment because the signal is usually generated at levels of one watt or less. To get from this level to a kilowatt requires about 30 db of gain. High gain tetrodes may be used to obtain this increase with a minimum number of stages and circuits. Each stage contributes some distortion; therefore, it is good practice to keep the number of stages to a minimum. It is generally considered good practice to operate the low level amplifiers below their maximum power capability in order to confine most of the distortion to the last two amplifier stages. *R-f feedback* can then be utilized to reduce the distortion in the last two stages. This type of feedback is no different from the common audio feedback used in high fidelity sound systems. A sample of the output waveform is applied to the amplifier input to correct the distortion developed in the amplifier. The same advantages can be obtained at radio frequencies that are obtained at audio frequencies when feedback is used.

14-1 R-F Feedback Circuits

R-f feedback circuits have been developed by the *Collins Radio Co.* for use with linear amplifiers. Tests with large receiving and small transmitting tubes showed that amplifiers using these tubes without feedback developed signal-to-distortion ratios no better than 30 db or so. Tests were run employing cathode follower circuits, such as shown in figure 1A. Lower distortion was achieved, but at the cost of low gain per stage. Since the voltage gain through the tube is less than unity, all gain has to be achieved by voltage step-up in the tank circuits. This gain is limited by the dissipation of the tank coils, since the circuit capacitance across the coils in a typical transmitter is quite high. In addition, the tuning of such a stage is sharp because of the high Q circuits.

The cathode follower performance of the tube can be retained by moving the r-f ground

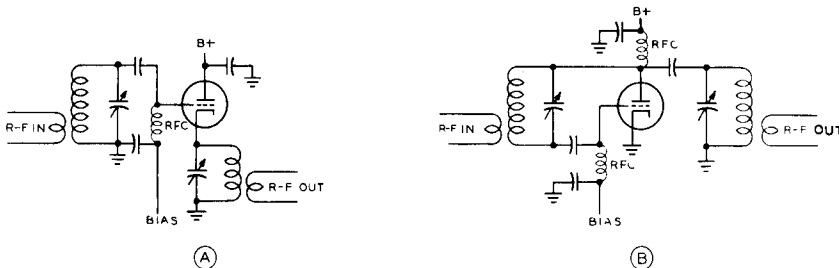

Figure 1
SIMILAR CATHODE FOLLOWER CIRCUITS HAVING DIFFERENT R-F GROUND POINTS.

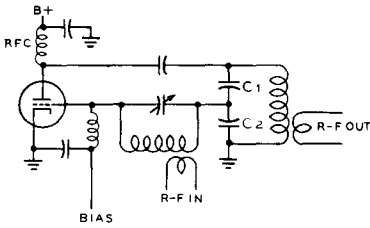

Figure 2
SINGLE STAGE AMPLIFIER WITH
R-F FEEDBACK CIRCUIT

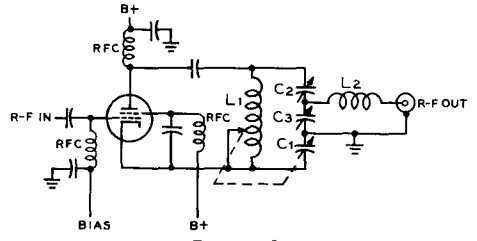

Figure 4
R-F AMPLIFIER WITH FEEDBACK
AND IMPEDANCE MATCHING
OUTPUT NETWORK.

Tuning and loading are accomplished by C_2 and C_3 . C_1 and L_1 are tuned in unison to establish the correct degree of feedback.

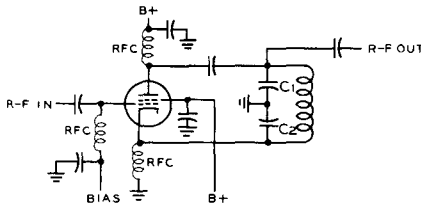

Figure 3
SINGLE STAGE FEEDBACK
AMPLIFIER WITH GROUND
RETURN POINT MODIFIED FOR
UNBALANCED INPUT AND
OUTPUT CONNECTIONS.

point of the circuit from the plate to the cathode as shown in figure 1B. Both ends of the input circuit are at high r-f potential so inductive coupling to this type of amplifier is necessary.

Inspection of figure 1B shows that by moving the top end of the input tank down on a voltage divider tap across the plate tank circuit, the feedback can be reduced from 100%, as in the case of the cathode follower circuit, down to any desired value. A typical feedback circuit is illustrated in figure 2. This circuit is more practical than those of figure 1, since the losses in the input tank are greatly reduced. A feedback level of 12 db may be achieved as a good compromise between distortion and stage gain. The voltage developed across C_2 will be three times the grid-cathode voltage.

Inductive coupling is required for this circuit, as shown in the illustration.

The circuit of figure 3 eliminates the need for inductive coupling by moving the r-f ground to the point common to both tank circuits. The advantages of direct coupling between stages far outweigh the disadvantages of having the r-f feedback voltage appear on the cathode of the amplifier tube.

In order to match the amplifier to a load, the circuit of figure 4 may be used. The ratio of X_{L_2} to X_{C_3} determines the degree of feedback, so it is necessary to tune them in unison when the frequency of operation is changed. Tuning and loading functions are accomplished by varying C_2 and C_3 . L_2 may also be varied to adjust the loading.

Feedback Around a Two-Stage Amplifier

The maximum phase shift obtainable over two simple tuned circuits does not exceed 180 degrees, and feedback around a two stage amplifier is possible. The basic circuit of a two stage feedback amplifier is shown in figure 5. This circuit is a conventional two-stage tetrode amplifier except that r-f is fed back from the plate circuit of the PA tube to the cathode of the driver tube. This will reduce the distortion

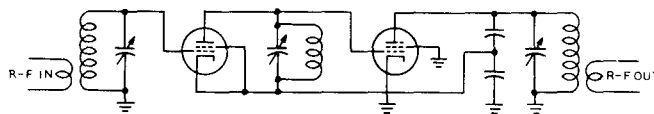

Figure 5
BASIC CIRCUIT OF TWO-STAGE AMPLIFIER WITH R-F FEEDBACK

Feedback voltage is obtained from a voltage divider across the output circuit and applied directly to the cathode of the first tube. The input tank circuit is thus outside the feedback loop.

of both tubes as effectively as using individual feedback loops around each stage, yet will allow a higher level of overall gain. With only two tuned circuits in the feedback loop, it is possible to use 12 to 15 db of feedback and still leave a wide margin for stability. It is possible to reduce the distortion by nearly as many db as are used in feedback. This circuit has two advantages that are lacking in the single stage feedback amplifier. First, the filament of the output stage can now be operated at r-f ground potential. Second, any conventional pi output network may be used.

R-f feedback will correct several types of distortion. It will help correct distortion caused by poor power supply regulation, too low grid bias, and limiting on peaks when the plate voltage swing becomes too high.

Neutralization and R-F Feedback The purpose of neutralization of an r-f amplifier stage is to balance out effects of the grid-plate capacitance coupling in the amplifier. In a conventional amplifier using a tetrode tube, the effective input capacity is given by:

$$\text{Input Capacitance} = C_{in} + C_{gp} (1 + A \cos \theta)$$

where: C_{in} = tube input capacitance

C_{gp} = grid-plate capacitance

A = voltage amplification from grid to plate

θ = phase angle of load

In a typical unneutralized tetrode amplifier having a stage gain of 33, the input capacitance of the tube with the plate circuit in resonance is increased by 8 μfd . due to the unneutralized grid-plate capacitance. This is unimportant in amplifiers where the gain (A) remains constant but if the tube gain varies, serious detuning and r-f phase shift may result. A grid or screen modulated r-f amplifier is an example of the case where the stage gain varies from a maximum down to zero. The gain of a tetrode r-f amplifier operating below plate current saturation varies with loading so that if it drives a following stage into grid current the loading increases and the gain falls off.

The input of the grid circuit is also affected by the grid-plate capacitance, as shown in this equation:

$$\text{Input Resistance} = \frac{1}{2\pi f \times C_{gp} (A \sin \theta)}$$

This resistance is in shunt with the grid current loading, grid tank circuit losses, and driving source impedance. When the plate cir-

cuit is inductive there is energy transferred from the plate to the grid circuit (positive feedback) which will introduce negative resistance in the grid circuit. When this shunt negative resistance across the grid circuit is lower than the equivalent positive resistance of the grid loading, circuit losses, and driving source impedance, the amplifier will oscillate.

When the plate circuit is in resonance (phase angle equal to zero) the input resistance due to the grid-plate capacitance becomes infinite. As the plate circuit is tuned to the capacitive side of resonance, the input resistance becomes positive and power is actually transferred from the grid to the plate circuit. This is the reason that the grid current in an unneutralized tetrode r-f amplifier varies from a low value with the plate circuit tuned on the low frequency side of resonance to a high value on the high frequency side of resonance. The grid current is proportional to the r-f voltage on the grid which is varying under these conditions. In a tetrode class AB_1 amplifier, the effect of grid-plate feedback can be observed by placing a r-f voltmeter across the grid circuit and observing the voltage change as the plate circuit is tuned through resonance.

If the amplifier is over-neutralized, the effects reverse so that with the plate circuit tuned to the low frequency side of resonance the grid voltage is high, and on the high frequency side of resonance, it is low.

Amplifier Neutralization Check A useful "rule of thumb" method of checking neutralization

of an amplifier stage (assuming that it is nearly correct to start with) is to tune both grid and plate circuits to resonance. Then, observing the r-f grid current, tune the plate circuit to the high frequency side of resonance. If the grid current rises, more neutralization capacitance is required. Conversely, if the grid current decreases, less capacitance is needed. This indication is very sensitive in a neutralized triode amplifier, and correct neutralization exists when the grid current peaks at the point of plate current dip. In tetrode power amplifiers this indication is less pronounced. Sometimes in a supposedly neutralized tetrode amplifier, there is practically no change in grid voltage as the plate circuit is tuned through resonance, and in some amplifiers it is unchanged on one side of resonance and drops slightly on the other side. Another observation sometimes made is a small dip in the center of a broad peak of grid current. These various effects are probably caused by

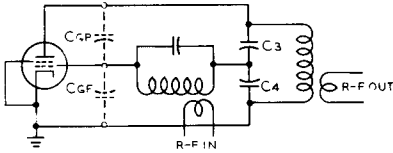

Figure 6
SINGLE STAGE R-F AMPLIFIER
WITH FEEDBACK RATIO OF
 C_3/C_4 TO C_{gp}/C_{gf} DETERMINES
STAGE NEUTRALIZATION

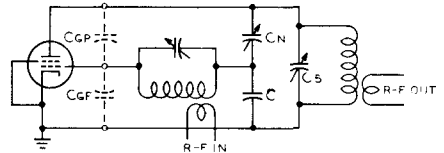

Figure 7
NEUTRALIZED AMPLIFIER AND
INHERENT FEEDBACK CIRCUIT.
Neutralization is achieved by varying
the capacity of C_n .

coupling from the plate to the grid circuit through other paths which are not balanced out by the particular neutralizing circuit used.

Feedback and Neutralization of a One-Stage R-F Amplifier

Figure 6 shows an r-f amplifier with negative feedback. The voltage developed across C_4 due to the voltage divider action of C_3 and C_4

is introduced in series with the voltage developed across the grid tank circuit and is in phase-opposition to it. The feedback can be made any value from zero to 100% by properly choosing the values of C_3 and C_4 .

For reasons stated previously, it is necessary to neutralize this amplifier, and the relationship for neutralization is:

$$\frac{C_3}{C_4} = \frac{C_{gp}}{C_{rt}}$$

It is often necessary to add capacitance from plate to grid to satisfy this relationship

Figure 7 is identical to figure 6 except that it is redrawn to show the feedback inherent in this neutralization circuit more clearly. C_n and C replace C_3 and C_4 , and the main plate tank tuning capacitance is C_s . The circuit of figure 7 presents a problem in coupling to the grid circuit. Inductive coupling is ideal, but the extra tank circuits complicate the tuning of a transmitter which uses several cascaded amplifiers with feedback around each one. The grid could be coupled to a high source impedance such as a tetrode plate, but the driver then cannot use feedback because this would cause the source impedance to be low. A possible solution is to move the circuit ground point from the cathode to the bottom end of the grid tank circuit. The feedback voltage then appears between the cathode and ground (figure 8). The input can be capacitively coupled, and the plate of the amplifier can be capacitively coupled to the next stage. Also, cathode type transmitting tubes are available that allow the heater to remain at ground po-

tential when r-f is impressed upon the cathode. The output voltage available with capacity coupling, of course, is less than the plate-cathode r-f voltage developed by the amount of feedback voltage across C_4 .

14-2 Feedback and Neutralization of a Two-Stage R-F Amplifier

Feedback around two r-f stages has the advantage that more of the tube gain can be realized and nearly as much distortion reduction can be obtained using 12 db around two stages as is realized using 12 db around each of two stages separately. Figure 9 shows a basic circuit of a two stage feedback amplifier. Inductive output coupling is used, although a pi-network configuration will also work well. The small feedback voltage required is obtained from the voltage divider $C_1 - C_2$ and is applied to the cathode of the driver tube. C_1 is only a few $\mu\text{mfd.}$, so this feedback voltage divider may be left fixed for a wide frequency range. If the combined tube gain is 160, and 12 db of feedback is desired, the ratio of C_2 to C_1 is about 40 to 1. This ratio in practice may be 400 $\mu\text{mfd.}$ to 2.5 $\mu\text{mfd.}$, for example.

A complication is introduced into this simplified circuit by the cathode-grid capacitance

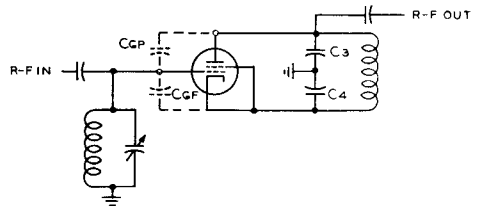

Figure 8
UNBALANCED INPUT AND OUTPUT
CIRCUITS FOR SINGLE-STAGE
R-F AMPLIFIER WITH FEEDBACK

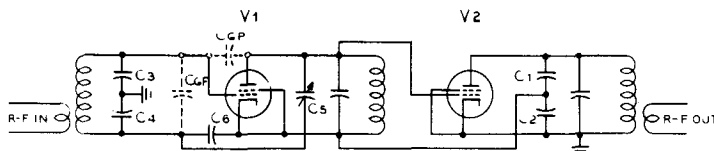

Figure 9

TWO-STAGE AMPLIFIER WITH FEEDBACK.

Included is a capacitor (C_5) for neutralizing the cathode-grid capacity of the first tube. V_1 is neutralized by capacitor C_5 , and V_2 is neutralized by the correct ratio of C_1/C_2 .

of the first tube which causes an undersired coupling to the input grid circuit. It is necessary to neutralize out this capacitance coupling, as illustrated in figure 9. The relationship for neutralization is:

$$\frac{C_3}{C_4} = \frac{C_{gp}}{C_6}$$

The input circuit may be made unbalanced by making C_4 five times the capacity of C_3 . This will tend to reduce the voltage across the coil and to minimize the power dissipated by the coil. For proper balance in this case, C_5 must be five times the grid-filament capacitance of the tube.

Except for tubes having extremely small grid-plate capacitance, it is still necessary to properly neutralize both tubes. If the ratio of C_1 to C_2 is chosen to be equal to the ratio of the grid-plate capacitance to the grid-filament capacitance in the second tube (V_2), this tube will be neutralized. Tubes such as a 4X-150A have very low grid-plate capacitance and probably will not need to be neutralized when used in the first (V_1) stage. If neutralization is necessary, capacitor C_5 is added for this purpose and the proper value is given by the following relationship:

$$\frac{C_{gp}}{C_6} = \frac{C_{gp}}{C_6} = \frac{C_3}{C_4}$$

If neither tube requires neutralization, the bottom end of the interstage tank circuit may be returned to r-f ground. The screen and suppressor of the first tube should then be grounded to keep the tank output capacitance directly across this interstage circuit and to avoid common coupling between the feedback on the cathode and the interstage circuit. A slight amount of degeneration occurs in the first stage since the tube also acts as a grounded grid amplifier with the screen as the grounded grid. The μ of the screen is much lower than that of the control grid so that this effect may be unnoticed and would only require slightly

more feedback from the output stage to overcome.

Tests For**Neutralization**

Neutralizing the circuit of figure 9 balances out coupling between the input tank circuit and the output tank circuit, but it does not remove all coupling from the plate circuit to the grid-cathode tube input. This latter coupling is degenerative, so applying a signal to the plate circuit will cause a signal to appear between grid and cathode, even though the stage is neutralized. A bench test for neutralization is to apply a signal to the plate of the tube and detect the presence of a signal in the grid coil by inductive coupling to it. No signal will be present when the stage is neutralized. Of course, a signal could be inductively coupled to the input and neutralization accomplished by adjusting one branch of the neutralizing circuit bridge (C_5 for example) for minimum signal on the plate circuit.

Neutralizing the cathode-grid capacitance of the first stage of figure 9 may be accomplished by applying a signal to the cathode of the tube and adjusting the bridge balance for minimum signal on a detector inductively coupled to the input coil.

Tuning a Two-Stage Feedback Amplifier

Tuning the two-stage feedback amplifier of figure 9 is accomplished in an unconventional way because the output circuit cannot be tuned for maximum output signal. This is because the output circuit must be tuned so the feedback voltage applied to the cathode is in-phase with the input signal applied to the first grid. When the feedback voltage is not in-phase, the resultant grid-cathode voltage increases as shown in figure 10. When the output circuit is properly tuned, the resultant grid-cathode voltage on the first tube will be at a minimum, and the voltage on the interstage tuned circuit will also be at a minimum.

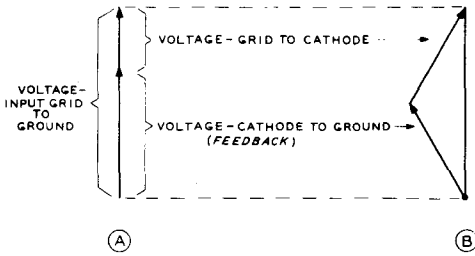

Figure 10
VECTOR RELATIONSHIP OF
FEEDBACK VOLTAGE

A = Output Circuit Properly Tuned
B = Output Circuit Mis-Tuned

The two-stage amplifier may be tuned by placing a r-f voltmeter across the interstage tank circuit ("hot" side to ground) and tuning the input and interstage circuits for maximum meter reading, and tuning the output circuit for minimum meter reading. If the second tube is driven into the grid current region, the grid current meter may be used in place of the r-f voltmeter. On high powered stages where operation is well into the Class AB region, the plate current dip of the output tube indicates correct output circuit tuning, as in the usual amplifier.

Parasitic Oscillations in the Feedback Amplifier

Quite often low frequency parasitics may be found in the interstage circuit of the two-stage feedback amplifier. Oscillation occurs in the first stage due to low frequency feedback in the cathode circuit. R-f chokes, coupling capacitors, and bypass capacitors provide the low frequency feedback. When the feedback and second stage neutralizing circuits are combined, it is necessary to use the configuration of figure 11. This circuit has the advantage that only one capacitor (C_3) is required from the plate of the output tube, thus keeping the added capacitance across the output tank at a minimum.

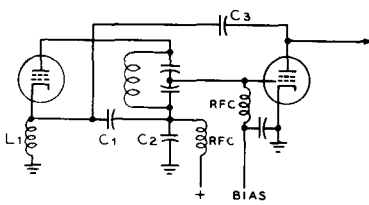

Figure 11
INTERSTAGE CIRCUIT COMBINING
NEUTRALIZATION AND
FEEDBACK NETWORKS.

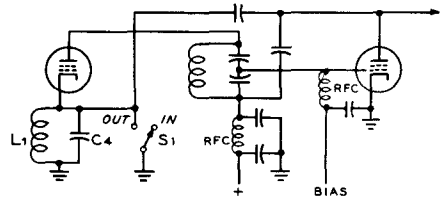

Figure 12
INTERSTAGE CIRCUIT WITH
SEPARATE NEUTRALIZING
AND FEEDBACK CIRCUITS.

It is convenient, however, to separate these circuits so neutralization and feedback can be adjusted independently. Also, it may be desirable to be able to switch the feedback out of the circuit. For these reasons, the circuit shown in figure 12 is often used. Switch S_1 removes the feedback loop when it is closed.

A slight tendency for low frequency parasitic oscillations still exists with this circuit. L_1 should have as little inductance as possible without upsetting the feedback. If the value of L_1 is too low, it cancels out part of the reactance of feedback capacitor C_4 and causes the feedback to increase at low values of radio frequency. In some cases, a swamping resistor may be necessary across L_1 . The value of this resistor should be high compared to the reactance of C_4 to avoid phase-shift of the r-f feedback.

14-3 Neutralization Procedure in Feedback-Type Amplifiers

Experience with feedback amplifiers has brought out several different methods of neutralizing. An important observation is that when all three neutralizing adjustments are correctly made the peaks and dips of various tuning meters all coincide at the point of circuit resonance. For example, the coincident indications when the various tank circuits are tuned through resonance with feedback operating are:

A—When the PA plate circuit is tuned through resonance:

- 1—PA plate current dip
- 2—Power output peak
- 3—PA r-f grid voltage dip
- 4—PA grid current dip

(Note: The PA grid current peaks when feedback circuit is disabled and the tube is heavily driven)

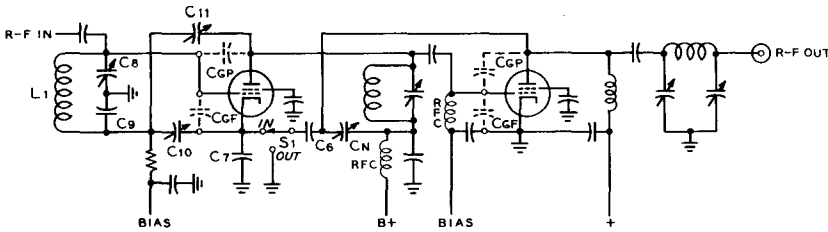

Figure 13
TWO-STAGE AMPLIFIER WITH FEED BACK CIRCUIT.

B—When the PA grid circuit is tuned through resonance:

- 1—Driver plate current dip
- 2—PA r-f grid voltage peak
- 3—PA grid current peak
- 4—PA power output peak

C—When the driver grid circuit is tuned through resonance:

- 1—Driver r-f grid voltage peak
- 2—Driver plate current peak
- 3—PA r-f grid current peak
- 4—PA plate current peak
- 5—PA power output peak

Four meters may be employed to measure the most important of these parameters. The meters should be arranged so that the following pairs of readings are displayed on meters located close together for ease of observation of coincident peaks and dips:

- 1—PA plate current and power output
- 2—PA r-f grid current and PA plate current
- 3—PA r-f grid voltage and power output
- 4—Driver plate current and PA r-f grid voltage

The third pair listed above may not be necessary if the PA plate current dip is pronounced. When this instrumentation is provided, the neutralizing procedure is as follows:

- 1—Remove the r-f feedback

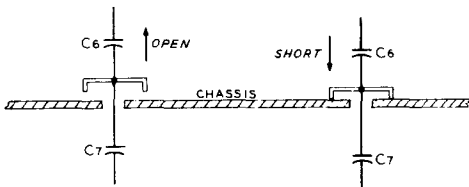

Figure 14
FEEDBACK SHORTING DEVICE.

2—Neutralize the grid-plate capacitance of the driver stage

3—Neutralize the grid-plate capacitance of the power amplifier (PA) stage

4—Apply r-f feedback

5—Neutralize driver grid-cathode capacitance

These steps will be explained in more detail in the following paragraphs:

Step 1. The removal of r-f feedback through the feedback circuit must be complete. The switch (S₁) shown in the feedback circuit (figure 13) is one satisfactory method. Since C₆ is effectively across the PA plate tank circuit it is desirable to keep it across the circuit when feedback is removed to avoid appreciable detuning of the plate tank circuit. Another method that can be used if properly done is to ground the junction of C₆ and C₇. Grounding this common point through a switch or relay is not good enough because of common coupling through the length of the grounding lead. The grounding method shown in figure 14 is satisfactory.

Step 2. Plate power and excitation are applied. The driver grid tank is resonated by tuning for a peak in driver r-f grid voltage or driver plate current. The power amplifier grid tank circuit is then resonated and adjusted for a dip in driver plate current. Driver neutralization is now adjusted until the PA r-f grid voltage (or PA grid current) peaks at exactly the point of driver plate current dip. A handy rule for adjusting grid-plate neutralization of a tube without feedback: with all circuits in resonance, detune the plate circuit to the high frequency side of resonance: If grid current to next stage (or power output of the stage under test) increases, more neutralizing capacitance is required and vice versa.

If the driver tube operates class A so that a plate current dip cannot be observed, a dif-

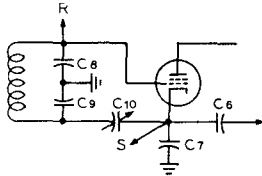

Figure 15
FEEDBACK NEUTRALIZING
CIRCUIT USING
AUXILIARY RECEIVER.

ferent neutralizing procedure is necessary. This will be discussed in a subsequent section.

Step 3. This is the same as step 2 except it is applied to the power amplifier stage. Adjust the neutralization of this stage for a peak in power output at the plate current dip.

Step 4. Reverse step 1 and apply the r-f feedback.

Step 5. Apply plate power and an exciting signal to drive the amplifier to nearly full output. Adjust the feedback neutralization for a peak in amplifier power output at the exact point of minimum amplifier plate current. Decrease the feedback neutralization capacitance if the power output rises when the tank circuit is tuned to the high frequency side of resonance.

The above sequence applies when the neutralizing adjustments are approximately correct to start with. If they are far off, some "cut-and-try" adjustment may be necessary. Also, the driver stage may break into oscillation if the feedback neutralizing capacitance is not near the correct setting.

It is assumed that a single tone test signal is used for amplifier excitation during the above steps, and that all tank circuits are at resonance except the one being detuned to make the observation. There is some interaction between the driver neutralization and the feedback neutralization so if an appreciable change is made in any adjustment the others should be rechecked. It is important that the grid-plate neutralization be accomplished first when using the above procedure, otherwise the feedback neutralization will be off a little, since it partially compensates for that error.

Neutralization Techniques

The method of neutralization employing a sensitive r-f detector inductively coupled to a tank coil is difficult to apply in some cases because of mechanical construction of the equipment, or because of undesired coupling. Another method for observing neutralization can be used, which appears to be more accurate in actual practice. A sensitive r-f detector such as a receiver is loosely coupled to the grid of the stage being neutralized, as shown in figure 15. The coupling capacitance is of the order of one or two μmfd . It must be small enough to avoid upsetting the neutralization when it is removed because the total grid-ground capacitance is one leg of the neutralizing bridge. A signal generator is connected at point S and the receiver at point R. If C_{10} is not properly adjusted the S-meter on the receiver will either kick up or down as the grid tank circuit is tuned through resonance. C_{10} may be adjusted for minimum deflection of the S-meter as the grid circuit is tuned through resonance.

The grid-plate capacitance of the tube is then neutralized by connecting the signal generator to the plate of the tube and adjusting C_{11} of figure 13 for minimum deflection again as the grid tank is tuned through resonance. The power amplifier stage is neutralized in the same manner by connecting a receiver loosely to the grid circuit, and attaching a signal generator to the plate of the tube. The r-f signal can be fed into the amplifier output terminal if desired.

Some precautions are necessary when using this neutralization method. First, some driver tubes (the 6CL6, for example) have appreciably more effective input capacitance when in operation and conducting plate current than when in standby condition. This increase in input capacitance may be as great as three or four μmfd , and since this is part of the neutralizing bridge circuit it must be taken into consideration. The result of this change in input capacitance is that the neutralizing adjustment of such tubes must be made when they are conducting normal plate current. Stray coupling must be avoided, and it may prove helpful to remove filament power from the preceding stage or disable its input circuit in some manner.

It should be noted that in each of the above adjustments that minimum reaction on the grid is desired, not minimum voltage. Some residual voltage is inherent on the grid when this neutralizing circuit is used.

Amplitude Modulation

If the output of a c-w transmitter is varied in amplitude at an audio frequency rate instead of interrupted in accordance with code characters, a tone will be heard on a receiver tuned to the signal. If the audio signal consists of a band of audio frequencies comprising voice or music intelligence, then the voice or music which is superimposed on the radio frequency carrier will be heard on the receiver.

When voice, music, video, or other intelligence is superimposed on a radio frequency carrier by means of a corresponding variation in the *amplitude* of the radio frequency output of a transmitter, *amplitude modulation* is the result. Telegraph keying of a c-w transmitter is the simplest form of amplitude modulation, while video modulation in a television transmitter represents a highly complex form. Systems for modulating the amplitude of a carrier envelope in accordance with voice, music, or similar types of complicated audio waveforms are many and varied, and will be discussed later on in this chapter.

15-1 Sidebands

Modulation is essentially a form of *mixing* or *combining* already covered in a previous chapter. To transmit voice at radio frequencies by means of amplitude modulation, the voice

frequencies are mixed with a radio frequency carrier so that the voice frequencies are converted to radio frequency *sidebands*. Though it may be difficult to visualize, *the amplitude of the radio frequency carrier does not vary during conventional amplitude modulation.*

Even though the amplitude of radio frequency voltage representing the composite signal (resultant of the carrier and sidebands, called the *envelope*) will vary from zero to twice the unmodulated signal value during full modulation, the amplitude of the *carrier* component does not vary. Also, so long as the amplitude of the modulating voltage does not vary, the amplitude of the sidebands will remain constant. For this to be apparent, however, it is necessary to measure the amplitude of each component with a highly selective filter. Otherwise, the measured power or voltage will be a *resultant* of two or more of the components, and the amplitude of the resultant will vary at the modulation rate.

If a carrier frequency of 5000 kc. is modulated by a pure tone of 1000 cycles, or 1 kc., two sidebands are formed: one at 5001 kc. (the sum frequency) and one at 4999 kc. (the difference frequency). The frequency of each sideband is independent of the amplitude of the modulating tone, or *modulation percentage*; the frequency of each sideband is determined only by the frequency of the modulating tone. This assumes, of course, that the transmitter is not modulated in excess of its linear capability.

When the modulating signal consists of multiple frequencies, as is the case with voice or music modulation, two sidebands will be formed by each modulating frequency (one on each side of the carrier), and the radiated signal will consist of a *band* of frequencies. The *band width*, or *channel* taken up in the frequency spectrum by a conventional double-sideband amplitude-modulated signal, is equal to twice the highest modulating frequency. For example, if the highest modulating frequency is 5000 cycles, then the signal (assuming modulation of complex and varying waveform) will occupy a band extending from 5000 cycles below the carrier to 5000 cycles above the carrier.

Frequencies up to at least 2500 cycles, and preferably 3500 cycles, are necessary for good speech intelligibility. If a filter is incorporated in the audio system to cut out all frequencies above approximately 3000 cycles, the band width of a radio-telephone signal can be limited to 6 kc. without a significant loss in intelligibility. However, if harmonic distortion is introduced subsequent to the filter, as would happen in the case of an overloaded modulator or overmodulation of the carrier, new frequencies will be generated and the signal will occupy a band wider than 6 kc.

15-2 Mechanics of Modulation

A c-w or unmodulated r-f carrier wave is represented in figure 1A. An audio frequency sine wave is represented by the curve of figure 1B. When the two are combined or "mixed," the carrier is said to be amplitude modulated, and a resultant similar to 1C or 1D is obtained. It should be noted that under modulation, each half cycle of r-f voltage differs slightly from the preceding one and the following one; therefore at no time during modulation is the r-f waveform a pure sine wave. This is simply another way of saying that during modulation, the transmitted r-f energy no longer is confined to a single radio frequency.

It will be noted that the *average* amplitude of the peak r-f voltage, or modulation envelope, is the same with or without modulation. This simply means that the modulation is symmetrical (assuming a symmetrical modulating wave) and that for distortionless modulation the upward modulation is limited to a value of twice the unmodulated carrier wave amplitude because the amplitude cannot go below zero on downward portions of the modulation cycle. Figure 1D illustrates the maxi-

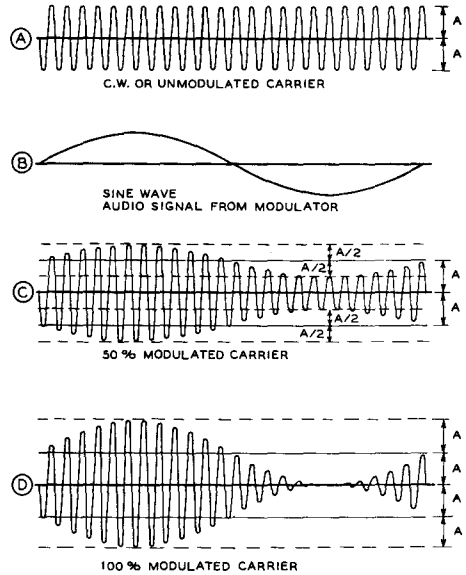

Figure 1
AMPLITUDE MODULATED WAVE

Top drawing (A) represents an unmodulated carrier wave; (B) shows the audio output of the modulator. Drawing (C) shows the audio signal impressed on the carrier wave to the extent of 50 per cent modulation; (D) shows the carrier with 100 per cent amplitude modulation.

mum obtainable distortionless modulation with a sine modulating wave, the r-f voltage at the peak of the r-f cycle varying from zero to twice the unmodulated value, and the r-f power varying from zero to four times the unmodulated value (the power varies as the square of the voltage).

While the average r-f voltage of the modulated wave over a modulation cycle is the same as for the unmodulated carrier, the average power increases with modulation. If the radio frequency power is integrated over the audio cycle, it will be found with 100 per cent sine wave modulation the average r-f power has increased 50 per cent. This additional power is represented by the sidebands, because as previously mentioned, the carrier power does not vary under modulation. Thus, when a 100-watt carrier is modulated 100 per cent by a sine wave, the total r-f power is 150 watts; 100 watts in the carrier and 25 watts in each of the two sidebands.

Modulation Percentage So long as the *relative proportion* of the various sidebands making up voice modulation is maintained, the signal may be received and detected without distortion. However, the higher the average amplitude of the sidebands, the greater the audio signal produced at the receiver. For this reason it is desirable to increase the *modulation percentage*, or degree of modulation, to the point where maximum peaks just hit 100 per cent. If the modulation percentage is increased so that the peaks exceed this value, distortion is introduced, and if carried very far, bad interference to signals on nearby channels will result.

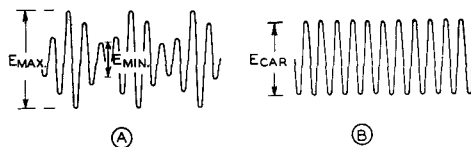

Figure 2
GRAPHICAL DETERMINATION OF MODULATION PERCENTAGE

The procedure for determining modulation percentage from the peak voltage points indicated is discussed in the text.

Modulation Measurement The amount by which a carrier is being modulated may be expressed either as a modulation factor, varying from zero to 1.0 at maximum modulation, or as a percentage. The percentage of modulation is equal to 100 times the modulation factor. Figure 2A shows a carrier wave modulated by a sine-wave audio tone. A picture such as this might be seen on the screen of a cathode-ray oscilloscope with sawtooth sweep on the horizontal plates and the modulated carrier impressed on the vertical plates. The same carrier without modulation would appear on the oscilloscope screen as figure 2B.

The percentage of modulation of the positive peaks and the percentage of modulation of the negative peaks can be determined separately from two oscilloscope pictures such as shown.

The modulation factor of the positive peaks may be determined by the formula:

$$M = \frac{E_{\max} - E_{\text{car}}}{E_{\text{car}}}$$

The factor for negative peaks may be determined from this formula:

$$M = \frac{E_{\text{car}} - E_{\min}}{E_{\text{car}}}$$

In the above two formulas E_{\max} is the maximum carrier amplitude with modulation and E_{\min} is the minimum amplitude; E_{car} is the steady-state amplitude of the carrier without modulation. Since the deflection of the spot on a cathode-ray tube is linear with respect to voltage, the relative voltages of these various amplitudes may be determined by measuring the deflections, as viewed on the screen, with a rule calibrated in inches or centimeters. The percentage of modulation of the carrier may be had by multiplying the modulation factor thus obtained by 100. The above procedure assumes that there is no

carrier shift, or change in average amplitude, with modulation.

If the modulating voltage is symmetrical, such as a sine wave, and modulation is accomplished without the introduction of distortion, then the percentage modulation will be the same for both negative and positive peaks. However, the distribution and phase relationships of harmonics in voice and music waveforms are such that the percentage modulation of the negative modulation peaks may exceed the percentage modulation of the positive peaks, and vice versa. The percentage modulation when referred to without regard to polarity is an indication of the average of the negative and positive peaks.

Modulation Capability The modulation capability of a transmitter is the maximum percentage to which that transmitter may be modulated before spurious sidebands are generated in the output or before the distortion of the modulating waveform becomes objectionable. The highest modulation capability which *any* transmitter may have on the *negative* peaks is 100 per cent. The maximum permissible modulation of many transmitters is less than 100 per cent, especially on positive peaks. The modulation capability of a transmitter may be limited by tubes with insufficient filament emission, by insufficient excitation or grid bias to a plate-modulated stage, too light loading of any type of amplifier carrying modulated r.f., insufficient power output capability in the modulator, or too much excitation to a grid-modulated stage or a Class B linear amplifier. In any case, the FCC regulations specify that no transmitter be modulated in excess of its modulation capability. Hence, it is desirable to make the modulation capability of a transmitter as near as possible to 100 per cent so that the carrier power may be used most effectively.

Speech Waveform Dissymmetry The manner in which the human voice is produced by the vocal cords gives rise to a certain dissymmetry in the waveform of voice sounds when they are picked up by a good-quality microphone. This is especially pronounced in the male voice, and more so on certain voiced sounds than on others. The result of this dissymmetry in the waveform is that the voltage peaks on one side of the average value of the wave will be considerably greater, often two or three times as great, as the voltage excursions on the other side of the zero axis. The *average* value of voltage on both sides of the wave is, of course, the same.

As a result of this dissymmetry in the male voice waveform, there is an optimum polarity of the modulating voltage that must be observed if maximum sideband energy is to be obtained without negative peak clipping and generation of "splatter" on adjacent channels.

A double-pole double-throw "phase reversing" switch in the input or output leads of any transformer in the speech amplifier system will permit poling the extended peaks in the direction of maximum modulation capability. The optimum polarity may be determined easily by listening on a selective receiver tuned to a frequency 30 to 50 kc. removed from the desired signal and adjusting the phase reversing switch to the position which gives the least "splatter" when the transmitter is modulated rather heavily. If desired, the switch then may be replaced with permanent wiring, so long as the microphone and speech system are not to be changed.

A more conclusive illustration of the lopsidedness of a speech waveform may be obtained by observing the modulated waveform of a radiotelephone transmitter on an oscilloscope. A portion of the carrier energy of the transmitter should be coupled by means of a link directly to the vertical plates of the 'scope, and the horizontal sweep should be a sawtooth or similar wave occurring at a rate of approximately 30 to 70 sweeps per second.

With the speech signal from the speech amplifier connected to the transmitter in one polarity it will be noticed that negative-peak clipping—as indicated by bright "spots" in the center of the 'scope pattern whenever the carrier amplitude goes to zero—will occur at a considerably lower level of average modulation than with the speech signal being fed to the transmitter in the other polarity. When the input signal to the transmitter is polarized in such a manner that the "fingers" of the speech wave extend in the direction of positive modulation these fingers usually will be clipped in the plate circuit of the modulator at an acceptable peak modulation level.

The use of the proper polarity of the incoming speech wave in modulating a transmitter can afford an increase of approximately two to one in the amount of speech audio power which may be placed upon the carrier for an amplitude-modulated transmitter for the same amount of sideband splatter. More effective methods for increasing the amount of audio power on the carrier of an AM phone transmitter are discussed later in this chapter.

Single-Sideband Transmission Because the same intelligibility is contained in each of the sidebands associated with a modulated carrier, it is not necessary to transmit sidebands on both sides of the carrier. Also, because the carrier is simply a single radio frequency wave of unvarying amplitude, it is not necessary to transmit the carrier if some means is provided for inserting a locally generated carrier at the receiver.

When the carrier is suppressed but both upper and lower sidebands are transmitted, it is necessary to insert a locally generated carrier at the receiver of *exactly* the same frequency and phase as the carrier which was suppressed. For this reason, suppressed-carrier double-sideband systems have little practical application.

When the carrier is suppressed and only the upper or the lower sideband is transmitted, a highly intelligible signal may be obtained at the receiver even though the locally generated carrier differs a few cycles from the frequency of the carrier which was suppressed at the transmitter. A communications system utilizing but one group of sidebands with carrier suppressed is known as a *single sideband system*. Such systems are widely used for commercial point to point work, and are being used to an increasing extent in amateur communication. The two chief advantages of the system are: (1) an effective power gain of about 9 db results from putting all the radiated power in intelligence carrying sideband frequencies instead of mostly into radiated carrier, and (2) elimination of the selective fading and distortion that normally occurs in a conventional double-sideband system when the carrier fades and the sidebands do not, or the sidebands fade differently.

15-3 Systems of Amplitude Modulation

There are many different systems and methods for amplitude modulating a carrier, but most may be grouped under three general classifications: (1) *variable efficiency* systems in which the average input to the stage re-

mains constant with and without modulation and the variations in the efficiency of the stage in accordance with the modulating signal accomplish the modulation; (2) *constant efficiency* systems in which the input to the stage is varied by an external source of modulating energy to accomplish the modulation; and (3) so-called *high-efficiency* systems in which circuit complexity is increased to ob-high plate circuit efficiency in the modulated stage without the requirement of an external high-level modulator. The various systems under each classification have individual characteristics which make certain ones best suited to particular applications.

Variable Efficiency Modulation Since the *average* input remains constant in a stage employing variable efficiency modulation, and since the average power output of the stage increases with modulation, the additional average power output from the stage *with* modulation must come from the plate dissipation of the tubes in the stage. Hence, for the best relation between tube cost and power output the tubes employed should have as high a plate dissipation rating per dollar as possible.

The plate efficiency in such an amplifier is doubled when going from the unmodulated condition to the peak of the modulation cycle. Hence, the unmodulated efficiency of such an amplifier *must always be less than 45 per cent*, since the maximum peak efficiency obtainable in a conventional amplifier is in the vicinity of 90 per cent. Since the peak efficiency in certain types of amplifiers will be as low as 60 per cent, the unmodulated efficiency in such amplifiers will be in the vicinity of 30 per cent.

Assuming a typical amplifier having a peak efficiency of 70 per cent, the following figures give an idea of the operation of an idealized efficiency-modulated stage adjusted for 100 per cent sine-wave modulation. It should be kept in mind that the plate voltage is constant at all times, even over the audio cycles.

Plate input without modulation.....100 watts
 Output without modulation..... 35 watts
 Efficiency without modulation..... 35%

Input on 100% positive modulation
 peak (plate current doubles).....200 watts
 Efficiency on 100% positive peak.... 70%
 Output on 100% positive modulation peak.....140 watts

Input on 100% negative peak..... 0 watts
 Efficiency on 100% negative peak.... 0%
 Output on 100% negative peak..... 0 watts

Average input with 100% modulation.....100 watts
 Average output with 100% modulation (35 watts carrier plus 17.5 watts sideband)52.5 watts
 Average efficiency with 100% modulation.....52.5%

Systems of Efficiency Modulation There are many systems of efficiency modulation, but they *all* have the general limitation discussed in the previous paragraph—so long as the carrier amplitude is to remain constant with and without modulation, the efficiency at carrier level must be not greater than one-half the peak modulation efficiency if the stage is to be capable of 100 per cent modulation.

The classic example of efficiency modulation is the Class B linear r-f amplifier, to be discussed below. The other three common forms of efficiency modulation are control-grid modulation, screen-grid modulation, and suppressor-grid modulation. In each case, including that of the Class B linear amplifier, note that the modulation, or the modulated signal, is impressed on a control electrode of the stage.

The Class B Linear Amplifier This is the simplest practical type amplifier for an amplitude-modulated wave or a single-sideband signal. The system possesses the disadvantage that excitation, grid bias, and loading must be carefully controlled to preserve the linearity of the stage. Also, the grid circuit of the tube, in the usual application where grid current is drawn on peaks, presents a widely varying value of load impedance to the source of excitation. Hence it is necessary to include some sort of *swamping resistor* to reduce the effect of grid-impedance variations with modulation. If such a swamping resistance across the grid tank is not included, or is too high in value, the positive modulation peaks of the incoming modulated signal will tend to be flattened with resultant distortion of the wave being amplified.

The Class B linear amplifier has long been used in broadcast transmitters, but recently has received much more general usage in the h-f range for two significant reasons: (a) the Class B linear is an excellent way of increasing the power output of a single-sideband transmitter, since the plate efficiency with full signal will be in the vicinity of 70 per cent, while with no modulation the input to the stage drops to a relatively low value; and (b) the Class B linear amplifier operates with relatively low harmonic output since the grid bias on the stage normally is slightly less

than the value which will cut off plate current to the stage in the absence of excitation.

Since a Class B linear amplifier is biased to *extended* cutoff with no excitation (the grid bias at extended cutoff will be approximately equal to the plate voltage divided by the amplification factor for a triode, and will be approximately equal to the screen voltage divided by the grid-screen mu factor for a tetrode or pentode) the plate current will flow essentially in 180-degree pulses. Due to the relatively large operating angle of plate current flow the theoretical peak plate efficiency is limited to 78.5 per cent, with 65 to 70 per cent representing a range of efficiency normally attainable, and the harmonic output will be low.

The carrier power output from a Class B linear amplifier of a normal 100 per cent modulated AM signal will be about one-half the rated plate dissipation of the stage, with optimum operating conditions. The peak output from a Class B linear, which represents the maximum-signal output as a single-sideband amplifier, or peak output with a 100 per cent AM signal, will be about twice the plate dissipation of the tubes in the stage. Thus the carrier-level input power to a Class B linear should be about 1.5 times the rated plate dissipation of the stage.

The schematic circuit of a Class B linear amplifier is the same as a conventional single-ended or push-pull stage, whether triodes or beam tetrodes are used. However, a swamping resistor, as mentioned before, must be placed across the grid tank of the stage if the operating conditions of the tube are such that appreciable grid current will be drawn on modulation peaks. Also, a *fixed* source of grid bias must be provided for the stage. A regulated grid-bias power supply is the usual source of negative bias voltage.

Adjustment of a Class B Linear Amplifier With grid bias adjusted to the correct value, and with provision for varying the excitation voltage to the stage and the loading of the plate circuit, a fully modulated signal is applied to the grid circuit of the stage. Then with an oscilloscope coupled to the output of the stage, excitation and loading are varied until the stage is drawing the normal plate input and the output waveform is a good replica of the input signal. The adjustment procedure normally will require a succession of approximations, until the optimum set of adjustments is attained. Then the modulation being applied to the input signal should be removed to check the linearity. With modulation removed, in the case of a 100 per cent AM signal, the input to the stage should remain constant, and the

peak output of the r-f envelope should fall to half the value obtained on positive modulation peaks.

Class C . Grid Modulation One widely used system of efficiency modulation for communications work is Class C control-grid bias modulation. The distortion is slightly higher than for a properly operated Class B linear amplifier, but the efficiency is also higher, and the distortion can be kept within tolerable limits for communications work.

Class C grid modulation requires high plate voltage on the modulated stage, if maximum output is desired. The plate voltage is normally run about 50 per cent higher than for maximum output with plate modulation.

The driving power required for operation of a grid-modulated amplifier under these conditions is somewhat more than is required for operation at lower bias and plate voltage, but the increased power output obtainable overbalances the additional excitation requirement. Actually, almost half as much excitation is required as would be needed if the same stage were to be operated as a Class C plate-modulated amplifier. The resistor R across the grid tank of the stage serves as *swamping* to stabilize the r-f driving voltage. At least 50 per cent of the output of the driving stage should be dissipated in this swamping resistor under carrier conditions.

A comparatively small amount of audio power will be required to modulate the amplifier stage 100 per cent. An audio amplifier having 20 watts output will be sufficient to modulate an amplifier with one kilowatt input. Proportionately smaller amounts of audio will be required for lower powered stages. However, the audio amplifier that is being used as the grid modulator should, in any case, either employ low plate resistance tubes such as 2A3's, employ degenerative feedback from the output stage to one of the preceding stages of the speech amplifier, or be resistance loaded with a resistor across the secondary of the modulation transformer. This provision of low driving impedance in the grid modulator is to insure good regulation in the audio driver for the grid modulated stage. Good regulation of both the audio and the r-f drivers of a grid-modulated stage is quite important if distortion-free modulation approaching 100 per cent is desired, because the grid impedance of the modulated stage varies widely over the audio cycle.

A practical circuit for obtaining grid-bias modulation is shown in figure 3. The modulator and bias regulator tube have been combined in a single 6B4G tube.

The regulator-modulator tube operates as a cathode-follower. The average d-c voltage

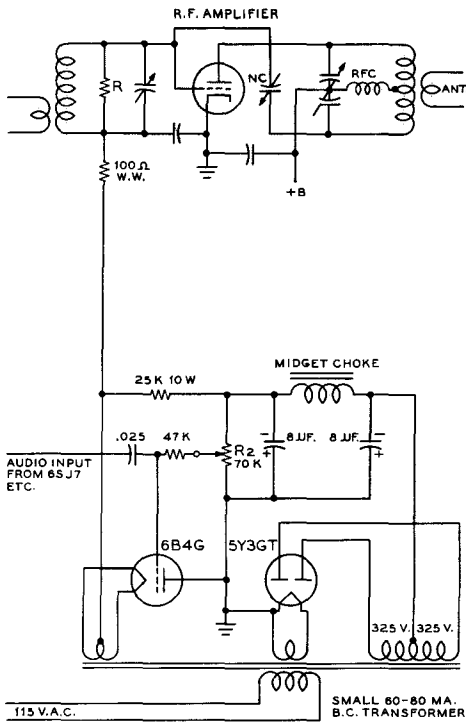

Figure 3
GRID-BIAS MODULATOR CIRCUIT

on the control grid is controlled by the 70,000-ohm wire-wound potentiometer and this potentiometer adjusts the average grid bias on the modulated stage. However, a-c signal voltage is also impressed on the control-grid of the tube and since the cathode follows this a-c wave the incoming speech wave is superimposed on the average grid bias, thus effecting grid-bias modulation of the r-f amplifier stage. An audio voltage swing is required on the grid of the 6B4G of approximately the same peak value as will be required as bias-voltage swing on the grid-bias modulated stage. This voltage swing will normally be in the region from 50 to 200 peak volts. Up to about 100 volts peak swing can be obtained from a 6SJ7 tube as a conventional speech amplifier stage. The higher voltages may be obtained from a tube such as a 6J5 through an audio transformer of 2:1 or 2½:1 ratio.

With the normal amount of comparatively tight antenna coupling to the modulated stage, a non-modulated carrier efficiency of 40 per cent can be obtained with substantially distortion-free modulation up to practically 100

per cent. If the antenna coupling is decreased slightly from the condition just described, and the excitation is increased to the point where the amplifier draws the same input, carrier efficiency of 50 per cent is obtainable with tolerable distortion at 90 per cent modulation.

Tuning the Grid-Bias Modulated Stage The most satisfactory procedure for tuning a stage for grid-bias modulation of the Class C type is as follows.

The amplifier should first be neutralized, and any possible tendency toward parasitics under any condition of operation should be eliminated. Then the antenna should be coupled to the plate circuit, the grid bias should be run up to the maximum available value, and the plate voltage and excitation should be applied. The grid bias voltage should then be reduced until the amplifier draws the approximate amount of plate current it is desired to run, and modulation corresponding to about 80 per cent is then applied. If the plate current kicks up when modulation is applied, the grid bias should be reduced; if the plate meter kicks down, increase the grid bias.

When the amount of bias voltage has been found (by adjusting the fine control, R_2 , on the bias supply) where the plate meter remains constant with modulation, it is more than probable that the stage will be drawing either too much or too little input. The antenna coupling should then be either increased or decreased (depending on whether the input was too little or too much, respectively) until the input is more nearly the correct value. The bias should then be readjusted until the plate meter remains constant with modulation as before. By slight jockeying back and forth of antenna coupling and grid bias, a point can be reached where the tubes are running at rated plate dissipation, and where the plate milliammeter on the modulated stage remains substantially constant with modulation.

The linearity of the stage should then be checked by any of the conventional methods; the trapezoidal pattern method employing a cathode-ray oscilloscope is probably the most satisfactory. The check with the trapezoidal pattern will allow the determination of the proper amount of gain to employ on the speech amplifier. Too much audio power on the grid of the modulated stage should not be used in the tuning-up process, as the plate meter will kick erratically and it will be impossible to make a satisfactory adjustment.

Screen-Grid Modulation Amplitude modulation may be accomplished by varying the screen-grid voltage in a Class C amplifier which employs a pentode, beam

tetrode, or other type of screen-grid tube. The modulation obtained in this way is not especially linear, but screen-grid modulation does offer other advantages and the linearity is quite adequate for communications work.

There are two significant and worthwhile advantages of screen-grid modulation for communications work: (1) The excitation requirements for an amplifier which is to be modulated in the screen are not at all critical, and good regulation of the excitation voltage is not required. The normal rated grid-circuit operating conditions specified for Class C c-w operation are quite adequate for screen-grid modulation. (2) The audio modulating power requirements for screen-grid modulation are relatively low.

A screen-grid modulated r-f amplifier operates as an efficiency-modulated amplifier, the same as does a Class B linear amplifier and a grid-modulated stage. Hence, *plate circuit* loading is relatively critical as in any efficiency-modulated stage, and must be adjusted to the correct value if normal power output with full modulation capability is to be obtained. As in the case of any efficiency-modulated stage, the operating efficiency at the peak of the modulation cycle will be between 70 and 80 per cent, with efficiency at the carrier level (if the stage is operating in the normal manner with full carrier) about half of the peak-modulation value.

There are two main disadvantages of screen-grid modulation, and several factors which must be considered if satisfactory operation of the screen-grid modulated stage is to be obtained. The disadvantages are: (1) As mentioned before, the linearity of modulation with respect to screen-grid voltage of such a stage is satisfactory only for communications work, unless carrier-rectified degenerative feedback is employed around the modulated stage to straighten the linearity of modulation. (2) The impedance of the screen grid to the modulating signal is non-linear. This means that the modulating signal must be obtained from a source of quite low impedance if audio distortion of the signal appearing at the screen grid is to be avoided.

Screen-Grid Impedance Instead of being linear with respect to modulating voltage, as is the plate circuit of a plate-modulated Class C amplifier, the screen grid presents approximately a square-law impedance to the modulating signal over the region of signal excursion where the screen is positive with respect to ground. This non-linearity may be explained in the following manner: At the carrier level of a conventional screen-modulated stage the plate-voltage swing of the modulated tube is one-half the voltage

swing at peak-modulation level. This condition must exist in any type of conventional efficiency-modulated stage if 100 per cent positive modulation is to be attainable. Since the plate-voltage swing is at half amplitude, and since the screen voltage is at half its full-modulation value, the screen current is relatively low. But at the positive modulation peak the screen voltage is approximately doubled, and the plate-voltage swing also is at twice the carrier amplitude. Due to the increase in plate-voltage swing with increasing screen voltage, the screen current increases more than linearly with increasing screen voltage.

In a test made on an amplifier with an 813 tube, the screen current at carrier level was about 6 ma. with screen potential of 190 volts; but under conditions which represented a positive modulation peak the screen current measured 25 ma. at a potential of 400 volts. Thus instead of screen current doubling with twice screen voltage as would be the case if the screen presented a resistive impedance, the screen current became about four times as great with twice the screen voltage.

Another factor which must be considered in the design of a screen-modulated stage, if full modulation is to be obtained, is that the power output of a screen-grid stage with zero screen voltage is still relatively large. Hence, if anything approaching full modulation on negative peaks is to be obtained, the screen potential must be made negative with respect to ground on negative modulation peaks. In the usual types of beam tetrode tubes the screen potential must be 20 to 50 volts negative with respect to ground before cut-off of output is obtained. This condition further complicates the problem of obtaining good linearity in the audio modulating voltage for the screen-modulated stage, since the screen voltage must be driven negatively with respect to ground over a portion of the cycle. Hence the screen draws *no* current over a portion of the modulating cycle, and over the major portion of the cycle when the screen does draw current, it presents approximately a square-law impedance.

Circuits for Screen-Grid Modulation Laboratory analysis of a large number of circuits for accomplishing screen modulation has led to the conclusion that the audio modulating voltage *must* be obtained from a low-impedance source if low-distortion modulation is to be obtained. Figure 4 shows a group of sketches of the modulation envelope obtained with various types of modulators and also with insufficient antenna coupling. The result of this laboratory work led to the conclusion that the cathode-follower modulator of the basic circuit shown in figure

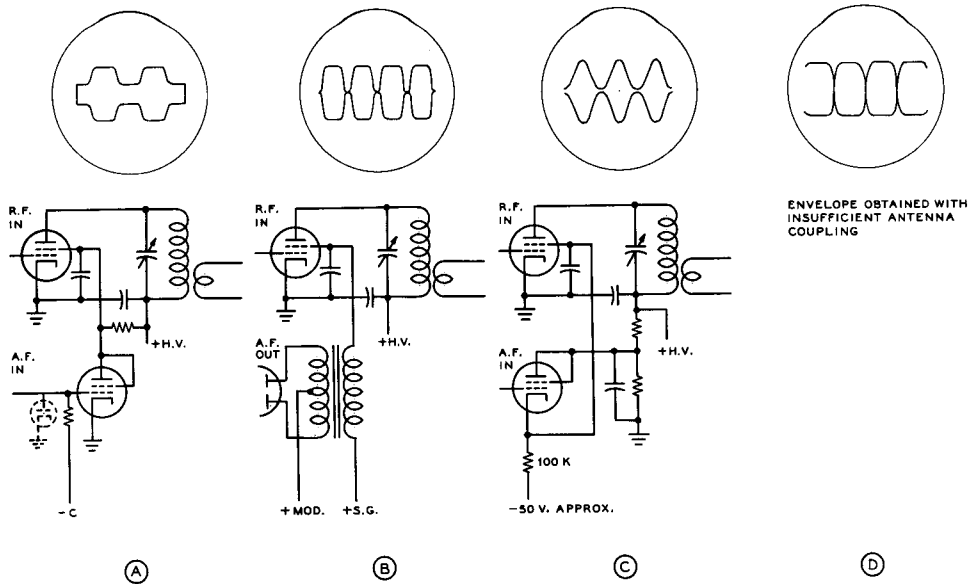

Figure 4

SCREEN-MODULATION CIRCUITS

Three common screen modulation circuits are illustrated above. All three circuits are capable of giving intelligible voice modulation although the waveform distortion in the circuits of (A) and (B) is likely to be rather severe. The arrangement at (A) is often called "clamp tube" screen modulation; by returning the grid leak on the clamp tube to ground the circuit will give controlled-carrier screen modulation. This circuit has the advantage that it is simple and is well suited to use in mobile transmitters. (B) is an arrangement using a transformer coupled modulator, and offers no particular advantages. The arrangement at (C) is capable of giving good modulation linearity due to the low impedance of the cathode-follower modulator. However, due to the relatively low heater-cathode ratings on tubes suited for use as the modulator, a separate heater supply for the modulator tube normally is required. This limitation makes application of the circuit to the mobile transmitter a special problem, since an isolated heater supply normally is not available. Shown at (D) as an assistance in the tuning of a screen-modulated transmitter (or any efficiency-modulated transmitter for that matter) is the type of modulation envelope which results when loading to the modulated stage is insufficient.

5 is capable of giving good-quality screen-grid modulation, and in addition the circuit provides convenient adjustments for the carrier level and the output level on *negative* modulation peaks. This latter control, P_2 in figure 5, allows the amplifier to be adjusted in such a manner that negative-peak clipping cannot take place, yet the negative modulation peaks may be adjusted to a level just above that at which sideband splatter will occur.

The Cathode-Follower Modulator

The cathode follower is ideally suited for use as the modulator for a screen-

grid stage since it acts as a relatively low-impedance source of modulating voltage for the screen-grid circuit. In addition the cathode-follower modulator allows the supply voltage both for the modulator and for the screen grid of the modulated tube to be obtained from the high-voltage supply for the plate of the screen-grid tube or beam tetrode. In the usual case the plate supply for the cathode follower, and hence for the screen grid of the modulated tube, may be taken from the bleeder on the high-voltage power supply. A tap on the bleeder may be used, or two resistors may be connected in series to make up the bleeder, with ap-

appropriate values such that the voltage applied to the plate of the cathode follower is appropriate for the tube to be modulated. It is important that a bypass capacitor be used from the plate of the cathode-follower modulator to ground.

The voltage applied to the plate of the cathode follower should be about 100 volts greater than the rated screen voltage for the tetrode tube as a c-w Class C amplifier. Hence the cathode-follower plate voltage should be about 350 volts for an 815, 2E26, or 829B, about 400 volts for an 807 or 4-125A, about 500 volts for an 813, and about 600 volts for a 4-250A or a 4E27. Then potentiometer P_1 in figure 5 should be adjusted until the carrier-level screen voltage on the modulated stage is about one-half the rated screen voltage specified for the tube as a Class C c-w amplifier. The current taken by the screen of the modulated tube under carrier conditions will be about one-fourth the normal screen current for c-w operation.

The only current taken by the cathode follower itself will be that which will flow through the 100,000-ohm resistor between the cathode of the 6L6 modulator and the negative supply. The current taken from the bleeder on the high-voltage supply will be the carrier-level screen current of the tube being modulated (which current passes of course through the cathode follower) plus that current which will pass through the 100,000-ohm resistor.

The loading of the modulated stage should be adjusted until the input to the tube is about 50 per cent greater than the rated plate dissipation of the tube or tubes in the stage. If the carrier-level screen voltage value is correct for linear modulation of the stage, the loading will have to be somewhat *greater* than that amount of loading which gives maximum output from the stage. The stage may then be modulated by applying an audio signal to the grid of the cathode-follower modulator, while observing the modulated envelope on an oscilloscope.

If good output is being obtained, and the modulation envelope appears as shown in figure 4C, all is well, except that P_2 in figure 5 should be adjusted until negative modulation peaks, even with excessive modulating signal, do not cause carrier cutoff with its attendant sideband splatter. If the envelope appears as at figure 4D, antenna coupling should be increased while the carrier level is backed down by potentiometer P_1 in figure 5 until a set of adjustments is obtained which will give a satisfactory modulation envelope as shown in figure 4C.

Changing Bands After a satisfactory set of adjustments has been obtained,

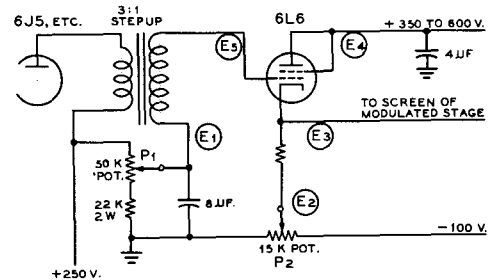

Figure 5
CATHODE-FOLLOWER
SCREEN-MODULATION CIRCUIT

A detailed discussion of this circuit, which also is represented in figure 4C, is given in the accompanying text.

it is *not* difficult to readjust the amplifier for operation on different bands. Potentiometers P_1 (carrier level), and P_2 (negative peak level) may be left fixed after a satisfactory adjustment, with the aid of the scope, has once been found. Then when changing bands it is only necessary to adjust excitation until the correct value of grid current is obtained, and then to adjust antenna coupling until correct plate current is obtained. Note that the correct plate current for an efficiency-modulated amplifier is only slightly less than the out-of-resonance plate current of the stage. Hence carrier-level screen voltage must be low so that the out-of-resonance plate current will not be too high, and relatively heavy antenna coupling must be used so that the operating plate current will be near the out-of-resonance value, and so that the operating input will be slightly greater than 1.5 times the rated plate dissipation of the tube or tubes in the stage. Since the carrier efficiency of the stage will be only 35 to 40 per cent, the tubes will be operating with plate dissipation of approximately the rated value without modulation.

Speech Clipping in the Modulated Stage The maximum r-f output of an efficiency-modulated stage is limited by the maximum possible plate voltage swing on positive modulation peaks. In the modulation circuit of figure 5 the *minimum* output is limited by the minimum voltage which the screen will reach on a negative modulation peak, as set by potentiometer P_2 . Hence the screen-grid-modulated stage, when using the modulator of figure 5, acts effectively as a speech clipper, provided the modulating signal amplitude is not too much more than that value

which will accomplish full modulation. With correct adjustments of the operating conditions of the stage it can be made to clip positive and negative modulation peaks symmetrically. However, the inherent peak clipping ability of the stage should *not* be relied upon as a means of obtaining a large amount of speech compression, since excessive audio distortion and excessive screen current on the modulated stage will result.

Characteristics of a Typical Screen-Modulated Stage An important characteristic of the screen-modulated stage, when using the cathode-follower modulator, is that excessive plate voltage on the modulated stage is not required. In fact, full output usually may be obtained with the larger tubes at an operating plate voltage from one-half to two-thirds the maximum rated plate voltage for c-w operation. This desirable condition is the natural result of using a low-impedance source of modulating signal for the stage.

As an example of a typical screen-modulated stage, full output of 75 watts of carrier may be obtained from an 813 tube operating with a plate potential of only 1250 volts. No increase in output from the 813 may be obtained by increasing the plate voltage, since the tube may be operated with full rated plate dissipation of 125 watts, with normal plate efficiency for a screen-modulated stage, 37.5 per cent, at the 1250-volt potential.

The operating conditions of a screen-modulated 813 stage are as follows:

Plate voltage—1250 volts
 Plate current—160 ma.
 Plate input—200 watts
 Grid current—11 ma.
 Grid bias—110 volts
 Carrier screen voltage—190 volts
 Carrier screen current—6 ma.
 Power output—approx. 75 watts

With full 100 per cent modulation the plate current increases about 2 ma. and the screen current increases about 1 ma.; hence plate, screen, and grid current remain essentially constant with modulation. Referring to figure 5, which was the circuit used as modulator for the 813, (E_1) measured plus 155 volts, (E_2) measured -50 volts, (E_3) measured plus 190 volts, (E_4) measured plus 500 volts, and the r.m.s. swing at (E_5) for full modulation measured 210 volts, which represents a peak swing of about 296 volts. Due to the high positive voltage, and the large audio swing, on the cathode of the 6L6 (triode connected) modulator tube, it is important that the heater of of this tube be fed from a separate filament

transformer or filament winding. Note also that the operating plate-to-cathode voltage on the 6L6 modulator tube does not exceed the 360-volt rating of the tube, since the operating potential of the cathode is considerably above ground potential.

Suppressor-Grid Modulation Still another form of efficiency modulation may be obtained by applying the audio modulating signal to the suppressor grid of a pentode Class C r-f amplifier. Basically, suppressor-grid modulation operates in the same general manner as other forms of efficiency modulation; carrier plate circuit efficiency is about 35 per cent, and antenna coupling must be rather tight. However, suppressor-grid modulation has one sizeable disadvantage, in addition to the fact that pentode tubes are not nearly so widely used as beam tetrodes which of course do not have the suppressor element. This disadvantage is that the screen-grid current to a suppressor-grid modulated amplifier is rather high. The high screen current is a natural consequence of the rather high negative bias on the suppressor grid, which reduces the plate-voltage swing and plate current with a resulting increase in the screen current.

In tuning a suppressor-grid modulated amplifier, the grid bias, grid current, screen voltage, and plate voltage are about the same as for Class C c-w operation of the stage. But the suppressor grid is biased negatively to a value which reduces the plate-circuit efficiency to about one-half the maximum obtainable from the particular amplifier, with antenna coupling adjusted until the plate input is about 1.5 times the rated plate dissipation of the stage. It is important that the input to the screen grid be measured to make sure that the rated screen dissipation of the tube is not being exceeded. Then the audio signal is applied to the suppressor grid. In the normal application the audio voltage swing on the suppressor will be somewhat greater than the negative bias on the element. Hence suppressor-grid current will flow on modulation peaks, so that the source of audio signal voltage must have good regulation. Tubes suitable for suppressor-grid modulation are: 2E22, 837, 4E27/8001, 5-125, 804 and 803. A typical suppressor-grid modulated amplifier is illustrated in figure 6.

15-4

Input Modulation Systems

Constant efficiency variable-input modulation systems operate by virtue of the addition

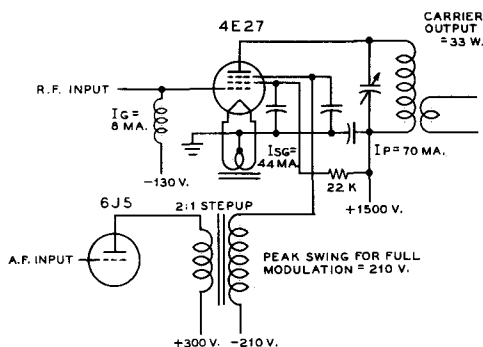

Figure 6
AMPLIFIER WITH SUPPRESSOR-GRID
MODULATION

Recommended operating conditions for linear suppressor-grid modulation of a 4E27/257B/8001 stage are given on the drawing.

of external power to the modulated stage to effect the modulation. There are two general classifications that come under this heading; those systems in which the additional power is supplied as audio frequency energy from a modulator, usually called plate modulation systems, and those systems in which the additional power to effect modulation is supplied as direct current from the plate supply.

Under the former classification comes Heising modulation (probably the oldest type of modulation to be applied to a continuous carrier), Class B plate modulation, and series modulation. These types of plate modulation are by far the easiest to get into operation, and they give a very good ratio of power input to the modulated stage to power output; 65 to 80 per cent efficiency is the general rule. It is for these two important reasons that these modulation systems, particularly Class B plate modulation, are at present the most popular for communications work.

Modulation systems coming under the second classification are of comparatively recent development but have been widely applied to broadcast work. There are quite a few systems in this class. Two of the more widely used are the Doherty linear amplifier, and the Terman-Woodyard high-efficiency grid-modulated amplifier. Both systems operate by virtue of a carrier amplifier and a peak amplifier connected together by electrical quarter-wave lines. They will be described later in this section.

Plate Modulation Plate modulation is the application of the audio power

to the plate circuit of an r-f amplifier. The r-f amplifier must be operated Class C for this type of modulation in order to obtain a radio-frequency output which changes in exact accordance with the variation in plate voltage. The r-f amplifier is 100 per cent modulated when the peak a-c voltage from the modulator is equal to the d.c. voltage applied to the r-f tube. The positive peaks of audio voltage increase the instantaneous plate voltage on the r-f tube to twice the d-c value, and the negative peaks reduce the voltage to zero.

The instantaneous plate current to the r-f stage also varies in accordance with the modulating voltage. The peak alternating current in the output of a modulator must be equal to the d-c plate current of the Class C r-f stage at the point of 100 per cent modulation. This combination of change in audio voltage and current can be most easily referred to in terms of audio power in watts.

In a sinusoidally modulated wave, the antenna current increases approximately 22 per cent for 100 per cent modulation with a pure tone input; an r-f meter in the antenna circuit indicates this increase in antenna current. The average power of the r-f wave increases 50 per cent for 100 per cent modulation, the efficiency remaining constant.

This indicates that in a plate-modulated radiotelephone transmitter, the audio-frequency channel must supply this additional 50 per cent increase in average power for sine-wave modulation. If the power input to the modulated stage is 100 watts, for example, the average power will increase to 150 watts at 100 per cent modulation, and this additional 50 watts of power must be supplied by the modulator when plate modulation is used. The actual antenna power is a constant percentage of the total value of input power.

One of the advantages of plate (or power) modulation is the ease with which proper adjustments can be made in the transmitter. Also, there is less plate loss in the r-f amplifier for a given value of carrier power than with other forms of modulation because the plate efficiency is higher.

By properly matching the plate impedance of the r-f tube to the output of the modulator, the ratio of voltage and current swing to d-c voltage and current is automatically obtained. The modulator should have a peak voltage output equal to the average d-c plate voltage on the modulated stage. The modulator should also have a peak power output equal to the d-c plate input power to the modulated stage.

The average power output of the modulator will depend upon the type of waveform. If the amplifier is being Heising modulated by a Class A stage, the modulator must have an average

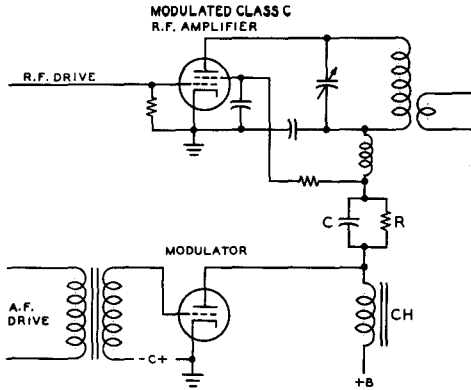

Figure 7

HEISING PLATE MODULATION

This type of modulation was the first form of plate modulation. It is sometimes known as "constant current" modulation. Because of the effective 1:1 ratio of the coupling choke, it is impossible to obtain 100 per cent modulation unless the plate voltage to the modulated stage is dropped slightly by resistor R. The capacitor C merely bypasses the audio around R, so that the full a-f output voltage of the modulator is impressed on the Class C stage.

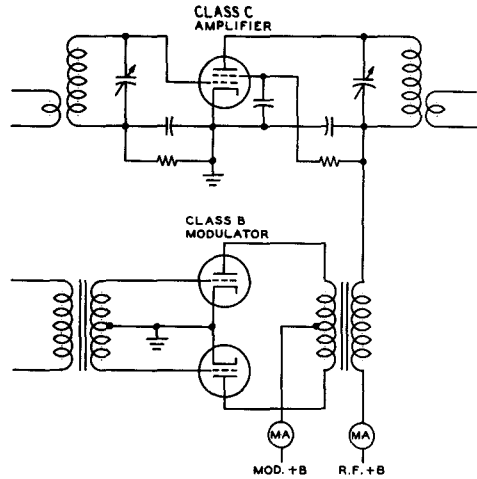

Figure 8

CLASS B PLATE MODULATION

This type of modulation is the most flexible in that the loading adjustment can be made in a short period of time and without elaborate test equipment after a change in operating frequency of the Class C amplifier has been made.

power output capability of one-half the input to the Class C stage. If the modulator is a Class B audio amplifier, the average power required of it may vary from one-quarter to more than one-half the Class C input depending upon the waveform. However, the *peak* power output of any modulator must be equal to the Class C input to be modulated.

Heising Modulation Heising modulation is the oldest system of plate modulation, and usually consists of a Class A audio amplifier coupled to the r-f amplifier by means of a modulation choke coil, as shown in figure 7.

The d.c. plate voltage and plate current in the r-f amplifier must be adjusted to a value which will cause the plate impedance to match the output of the modulator, since the modulation choke gives a 1-to-1 coupling ratio. A series resistor, by-passed for audio frequencies by means of a capacitor, must be connected in series with the plate of the r-f amplifier to obtain modulation up to 100 per cent. The peak output voltage of a Class A amplifier does not reach a value equal to the d-c voltage applied to the amplifier and, consequently, the d-c plate voltage impressed across the r-f tube must be reduced to a value equal to

the maximum available a-c peak voltage if 100% modulation is to be obtained.

A higher degree of distortion can be tolerated in low-power emergency phone transmitters which use a pentode modulator tube, and the series resistor and by-pass capacitor are usually omitted in such transmitters.

Class B Plate Modulation High-level Class B plate modulation is the least expensive method of plate modulation. Figure 8 shows a conventional Class B plate-modulated Class C amplifier.

The statement that the modulator output power must be one-half the Class C input for 100 per cent modulation is correct only if the waveform of the modulating power is a *sine wave*. Where the modulator waveform is unclipped speech, the average modulator power for 100 per cent modulation is considerably less than one-half the Class C input.

Power Relations in Speech Waveforms It has been determined experimentally that the ratio of peak to average power in a speech waveform is approximately 4 to 1 as contrasted to a ratio of 2 to 1 in a sine wave. This is due to the high harmonic content of such a waveform, and to the fact that

this high harmonic content manifests itself by making the wave unsymmetrical and causing sharp peaks or "fingers" of high energy content to appear. Thus for unclipped speech, the *average* modulator plate current, plate dissipation, and power output are approximately one-half the sine wave values for a given *peak* output power.

Both peak power and average power are necessarily associated with waveform. *Peak* power is just what the name implies; the power at the peak of a wave. Peak power, although of the utmost importance in modulation, is of no great significance in a-c power work, except insofar as the *average* power may be determined from the peak value of a known wave form.

There is no time element implied in the definition of peak power; peak power may be instantaneous—and for this reason average power, which is definitely associated with time, is the important factor in plate dissipation. It is possible that the peak power of a given waveform be several times the average value; for a sine wave, the peak power is twice the average value, and for unclipped speech the peak power is approximately four times the *average* value. For 100 per cent modulation, the *peak* (instantaneous) audio power must equal the Class C input, although the average power for this value of peak varies widely depending upon the modulator waveform, being greater than 50 per cent for speech that has been clipped and filtered, 50 per cent for a sine wave, and about 25 per cent for typical unclipped speech tones.

Modulation Transformer Calculations The modulation transformer is a device for matching the load impedance of the Class C amplifier to the recommended load impedance of the Class B modulator tubes. Modulation transformers intended for communications work are usually designed to carry the Class C plate current through their secondary windings, as shown in figure 8. The manufacturer's ratings should be consulted to insure that the d-c plate current passed through the secondary winding does not exceed the maximum rating.

A detailed discussion of the method of making modulation transformer calculations has been given in Chapter Six. However, to emphasize the method of making the calculation, an additional example will be given.

Suppose we take the case of a Class C amplifier operating at a plate voltage of 2000 with 225 ma. of plate current. This amplifier would present a load resistance of 2000 divided by 0.225 amperes or 8888 ohms. The plate power input would be 2000 times 0.225 or 450 watts. By reference to Chapter Six we see that

a pair of 811 tubes operating at 1500 plate volts will deliver 225 watts of audio output. The plate-to-plate load resistance for these tubes under the specified operating conditions is 18,000 ohms. Hence our problem is to match the Class C amplifier load resistance of 8888 ohms to the 18,000-ohm load resistance required by the modulator tubes.

A 200-to-300 watt modulation transformer will be required for the job. If the taps on the transformer are given in terms of impedances it will only be necessary to connect the secondary for 8888 ohms (or a value approximately equal to this such as 9000 ohms) and the primary for 18,000 ohms. If it is necessary to determine the proper turns ratio required of the transformer it can be determined in the following manner. The square root of the impedance ratio is equal to the turns ratio, hence:

$$\sqrt{\frac{8888}{18000}} = \sqrt{0.494} = 0.703$$

The transformer must have a turns ratio of approximately 1-to-0.7 step down, total primary to total secondary. The greater number of turns always goes with the higher impedance, and vice versa.

Plate-and-Screen Modulation When *only* the plate of a screen-grid tube is modulated, it is impossible to obtain high-percentage linear modulation under ordinary conditions. The plate current of such a stage is not linear with plate voltage. However, if the screen is modulated simultaneously with the plate, the instantaneous screen voltage drops in proportion to the drop in the plate voltage, and linear modulation can then be obtained. Four satisfactory circuits for accomplishing combined plate and screen modulation are shown in figure 9.

The screen r-f by-pass capacitor C_2 , should not have a greater value than 0.005 $\mu\text{fd.}$, preferably not larger than 0.001 $\mu\text{fd.}$ It should be large enough to bypass effectively all r-f voltage without short-circuiting high-frequency audio voltages. The plate by-pass capacitor can be of any value from 0.002 $\mu\text{fd.}$ to 0.005 $\mu\text{fd.}$ The screen-dropping resistor, R_1 , should reduce the applied high voltage to the value specified for operating the particular tube in the circuit. Capacitor C_1 is seldom required yet some tubes may require this capacitor in order to keep C_2 from attenuating the high frequencies. Different values between .002 and .002 $\mu\text{fd.}$ should be tried for best results.

Figure 9C shows another method which uses a third winding on the modulation transformer, through which the screen-grid is connected to

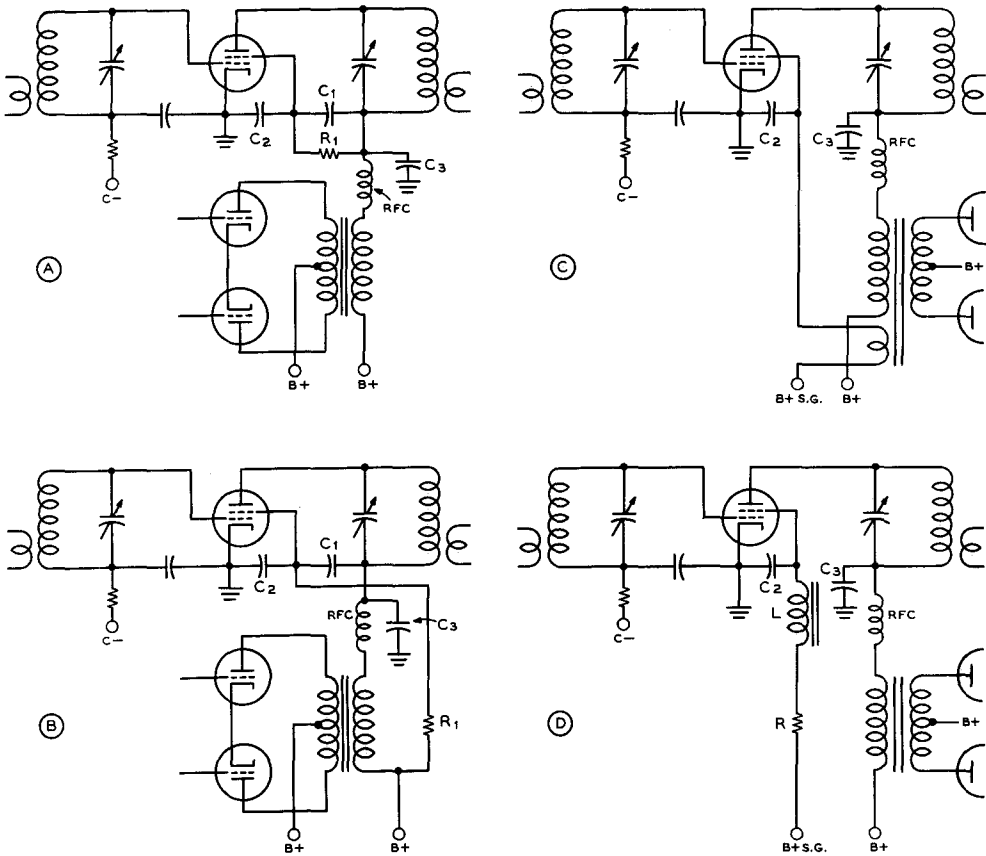

Figure 9

PLATE MODULATION OF A BEAM TETRODE OR SCREEN-GRID TUBE

These alternative arrangements for plate modulation of tetrodes or pentodes are discussed in detail in the text. The arrangements shown at (B) or (D) are recommended for most applications.

a low-voltage power supply. The ratio of turns between the two output windings depends upon the type of screen-grid tube which is being modulated. Normally it will be such that the screen voltage is being modulated 60 per cent when the plate voltage is receiving 100 per cent modulation.

If the screen voltage is derived from a dropping resistor (*not* a divider) that is bypassed for r.f. but not a.f., it is possible to secure quite good modulation by applying modulation only to the plate. Under these conditions, the screen tends to modulate itself, the screen voltage varying over the audio cycle as a result of the screen impedance increasing with plate voltage, and decreasing with a decrease

in plate voltage. This circuit arrangement is illustrated in figure 9B.

A similar application of this principle is shown in figure 9D. In this case the screen voltage is fed directly from a low-voltage supply of the proper potential through a choke L. A conventional filter choke having an inductance from 10 to 20 henries will be satisfactory for L.

To afford protection of the tube when plate voltage is not applied but screen voltage is supplied from the exciter power supply, when using the arrangement of figure 9D, a resistor of 3000 to 10,000 ohms can be connected in series with the choke L. In this case the screen supply voltage should be at least 1½ times as

much as is required for actual screen voltage, and the value of resistor is chosen such that with normal screen current the drop through the resistor and choke will be such that normal screen voltage will be applied to the tube. When the plate voltage is removed the screen current will increase greatly and the drop through resistor R will increase to such a value that the screen voltage will be lowered to the point where the screen dissipation on the tube will not be exceeded. However, the supply voltage and value of resistor R must be chosen carefully so that the maximum rated screen dissipation cannot be exceeded. The maximum possible screen dissipation using this arrangement is equal to: $W = E^2/4R$ where E is the screen supply voltage and R is the combined resistance of the resistor in figure 9D and the d-c resistance of the choke L. It is wise, when using this arrangement to check, using the above formula, to see that the value of W obtained is less than the maximum rated screen dissipation of the tube or tubes used in the modulated stage. This same system can of course also be used in figuring the screen supply circuit of a pentode or tetrode amplifier stage where modulation is not to be applied.

The modulation transformer for plate-and-screen-modulation, when utilizing a dropping resistor as shown in figure 9A, is similar to the type of transformer used for any plate modulated phone. The combined screen and plate current is divided into the plate voltage in order to obtain the Class C amplifier load impedance. The peak audio power required to obtain 100 per cent modulation is equal to the d-c power input to the screen, screen resistor, and plate of the modulated r-f stage.

15-5 Cathode Modulation

Cathode modulation offers a workable compromise between the good plate efficiency but expensive modulator of high-level plate modulation, and the poor plate efficiency but inexpensive modulator of grid modulation. Cathode modulation consists essentially of an admixture of the two.

The efficiency of the average well-designed plate-modulated transmitter is in the vicinity of 75 to 80 per cent, with a compromise perhaps at 77.5 per cent. On the other hand, the efficiency of a good grid-modulated transmitter may run from 28 to maybe 40 per cent, with the average falling at about 34 per cent. Now since cathode modulation consists of simultaneous grid and plate modulation, in phase with each other, we can theoretically obtain any efficiency from about 34 to 77.5 per cent from our cathode-modulated stage, depending

upon the relative percentages of grid and plate modulation.

Since the system is a compromise between the two fundamental modulation arrangements, a value of efficiency approximately half way between the two would seem to be the best compromise. Experience has proved this to be the case. A compromise efficiency of about 56.5 per cent, roughly half way between the two limits, has proved to be optimum. Calculation has shown that this value of efficiency can be obtained from a cathode-modulated amplifier when the audio-frequency modulating power is approximately 20 per cent of the d-c input to the cathode-modulated stage.

An Economical Series Cathode Modulator Series cathode modulation is ideally suited as an economical modulating arrangement for a high-power triode c-w transmitter. The modulator can be constructed quite compactly and for a minimum component cost since no power supply is required for it. When it is desired to change over from c-w to 'phone, it is only necessary to cut the series modulator into the cathode return circuit of the c-w amplifier stage. The plate voltage for the modulator tubes and for the speech amplifier is taken from the cathode voltage drop of the modulated stage across the modulator unit.

Figure 10 shows the circuit of such a modulator, designed to cathode modulate a Class C amplifier using push-pull 810 tubes, running at a supply voltage of 2500, and with a plate input of 660 watts. The modulated stage runs at about 50% efficiency, giving a power output of nearly 350 watts, fully modulated. The voltage drop across the cathode modulator is 400 volts, allowing a net plate to cathode voltage of 2100 volts on the final amplifier. The plate current of the 810's should be about 330 ma., and the grid current should be approximately 40 ma., making the total cathode current of the modulated stage 370 ma. Four parallel 6L6 modulator tubes can pass this amount of plate current without difficulty. It must be remembered that the voltage drop across the cathode modulator is also the cathode bias of the modulated stage. In most cases, no extra grid bias is necessary. If a bias supply is used for c-w operation, it may be removed for cathode modulation, as shown in figure 11. With low-mu triodes, some extra grid bias (over and above that amount supplied by the cathode modulator) may be needed to achieve proper linearity of the modulated stage. In any case, proper operation of a cathode modulated stage should be determined by examining the modulated output waveform of the stage on an oscilloscope.

Excitation The r-f driver for a cathode-modulated stage should have about

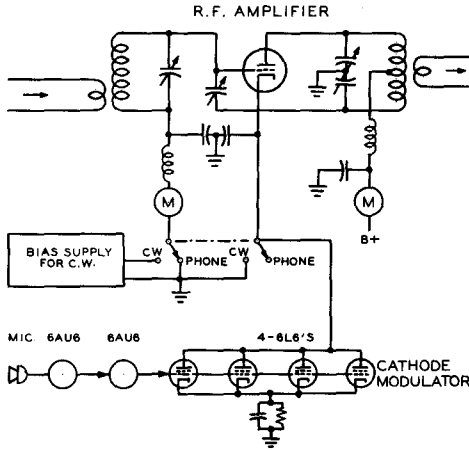

Figure 11
CATHODE MODULATOR INSTALLATION
SHOWING PHONE-C.W. TRANSFER SWITCH

the $R/2$ that is presented under the carrier conditions. This is true because at a positive modulation peak (since it is delivering full power) the peak tube subtracts a negative resistance of $R/2$ from the load end of the line.

Now, since under the peak condition of modulation the load end of the line is terminated in R ohms instead of $R/2$, the impedance at the carrier-tube will be reduced from $2R$ ohms to R ohms. This again is due to the impedance inverting action of the line. Since the load resistance on the carrier tube has been reduced to half the carrier value, its output at the peak of the modulation cycle will be doubled. Thus we have the necessary condition for a 100 per cent modulation peak; the amplifier will deliver four times as much power as it does under the carrier conditions.

On negative modulation peaks the peak tube does not contribute; the output of the carrier tube is reduced until on a 100 per cent negative peak its output is zero.

The Electrical Quarter-Wave Line While an electrical quarter-wave line (consisting of a pi network with the inductance and capacitance units having a reactance equal to the characteristic impedance of the line) does have the desired impedance-inverting effect, it also has the undesirable effect of introducing a 90° phase shift across such a line. If the shunt elements are capacitances, the phase shift across the line lags by 90° ; if they are inductances, the phase shift leads by 90° . Since there is an un-

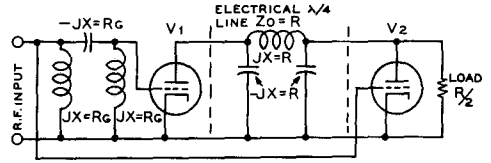

Figure 12
DIAGRAMMATIC REPRESENTATION OF
THE DOHERTY LINEAR

desirable phase shift of 90° between the plate circuits of the carrier and peak tubes, an equal and opposite phase shift must be introduced in the exciting voltage to the grid circuits of the two tubes so that the resultant output in the plate circuit will be in phase. This additional phase shift has been indicated in figure 12 and a method of obtaining it has been shown in figure 13.

Comparison Between Linear and Grid Modulator The difference between the Doherty linear amplifier and the Terman-Woodyard grid-modulated amplifier is the same as the difference between any linear and grid-modulated stages. Modulated r.f. is applied to the grid circuit of the Doherty linear amplifier with the carrier tube biased to cutoff and the peak tube biased to the point where it draws substantially zero plate current at the carrier condition.

In the Terman-Woodyard grid-modulated amplifier the carrier tube runs Class C with comparatively high bias and high plate efficiency, while the peak tube again is biased so that it draws almost no plate current. Unmodulated r.f. is applied to the grid circuits of the two tubes and the modulating voltage is inserted in series with the fixed bias voltages. From one-half to two-thirds as much audio voltage is required at the grid of the peak tube as is required at the grid of the carrier tube.

Operating Efficiencies The resting carrier efficiency of the grid-modulated amplifier may run as high as is obtainable in any Class C stage, 80 per cent or better. The resting carrier efficiency of the linear will be about as good as is obtainable in any Class B amplifier, 60 to 70 per cent. The overall efficiency of the bias-modulated amplifier at 100 per cent modulation will run about 75 per cent; of the linear, about 60 per cent.

In figure 13 the plate tank circuits are detuned enough to give an effect equivalent to the shunt elements of the quarter-wave "line" of figure 12. At resonance, the coils L_1 and L_2 in the grid circuits of the two tubes have

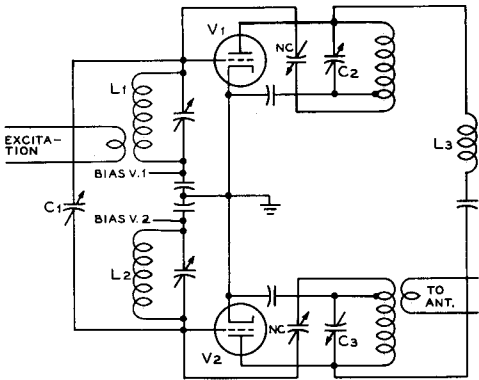

Figure 13

SIMPLIFIED SCHEMATIC OF A "HIGH EFFICIENCY" AMPLIFIER

The basic system, comprising a "carrier" tube and a "peak" tube interconnected by lumped-constant quarter-wave lines, is the same for either grid-bias modulation or for use as a linear amplifier of a modulated wave.

each an inductive reactance equal to the capacitive reactance of the capacitor C_1 . Thus we have the effect of a pi network consisting of shunt inductances and series capacitance. In the plate circuit we want a phase shift of the same magnitude but in the opposite direction; so our series element is the inductance L_3 whose reactance is equal to the characteristic impedance desired of the network. Then the plate tank capacitors of the two tubes C_2 and C_3 are increased an amount past resonance, so that they have a capacitive reactance equal to the inductive reactance of the coil L_3 . It is quite important that there be no coupling between the inductors.

Although both these types of amplifiers are highly efficient and require no high-level audio equipment, they are difficult to adjust—particularly so on the higher frequencies—and it would be an extremely difficult problem to design a multiband transmitter employing the circuit. However, the grid-bias modulation system has advantages for the high-power transmitter which will be operated on a single frequency band.

Other High-Efficiency Modulation Systems

Many other high-efficiency modulation systems have been described since about 1936. The majority of these, however have received little application either by commercial interests or by amateurs. In most cases the circuits are difficult to adjust, or they have

other undesirable features which make their use impracticable alongside the more conventional modulation systems. Nearly all these circuits have been published in the *I.R.E. Proceedings* and the interested reader can refer to them in back copies of that journal.

15-7 Speech Clipping

Speech waveforms are characterized by frequently recurring high-intensity peaks of very short duration. These peaks will cause over-modulation if the *average* level of modulation on loud syllables exceeds approximately 30 per cent. Careful checking into the nature of speech sounds has revealed that these high-intensity peaks are due primarily to the vowel sounds. Further research has revealed that the vowel sounds add little to intelligibility, the major contribution to intelligibility coming from the consonant sounds such as *v, b, k, s, t, and l*. Measurements have shown that the power contained in these consonant sounds may be down 30 db or more from the energy in the vowel sounds in the same speech passage. Obviously, then, if we can increase the relative energy content of the consonant sounds with respect to the vowel sounds it will be possible to understand a signal modulated with such a waveform in the presence of a much higher level of background noise and interference. Experiment has shown that it is possible to accomplish this desirable result simply by cutting off or *clipping* the high-intensity peaks and thus building up in a relative manner the effective level of the weaker sounds.

Such clipping theoretically can be accomplished simply by increasing the gain of the speech amplifier until the average level of modulation on loud syllables approaches 90 per cent. This is equivalent to increasing the speech power of the consonant sounds by about 10 times or, conversely, we can say that 10 db of clipping has been applied to the voice wave. However, the clipping when accomplished in this manner *will produce higher order sidebands known as "splatter,"* and the transmitted signal would occupy a relatively tremendous slice of spectrum. So another method of accomplishing the desirable effects of clipping must be employed.

A considerable reduction in the amount of splatter caused by a moderate increase in the gain of the speech amplifier can be obtained by *poling* the signal from the speech amplifier to the transmitter such that the high-intensity peaks occur on *upward* or positive modulation. Overloading on positive modulation peaks produces less splatter than the negative-peak clipping which occurs with overloading on the

Figure 14
SPEECH-WAVEFORM AMPLITUDE MODULATION

Showing the effect of using the proper polarity of a speech wave for modulating a transmitter. (A) shows the effect of proper speech polarity on a transmitter having an upward modulation capability of greater than 100 per cent. (B) shows the effect of using proper speech polarity on a transmitter having an upward modulation capability of only 100 per cent. Both these conditions will give a clean signal without objectionable splatter. (C) shows the effect of the use of improper speech polarity. This condition will cause serious splatter due to negative-peak clipping in the modulated-amplifier stage.

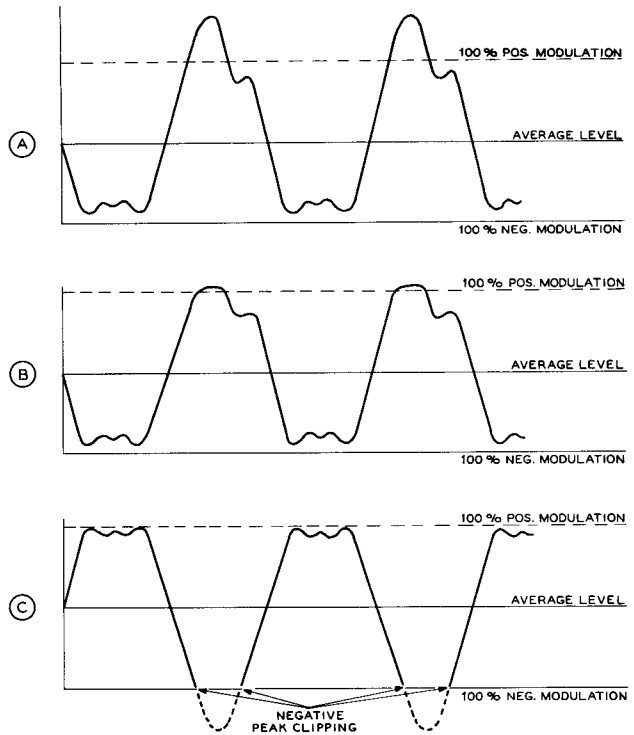

negative peaks of modulation. This aspect of the problem has been discussed in more detail in the section on *Speech Waveform Dissymmetry* earlier in this chapter. The effect of feeding the proper speech polarity from the speech amplifier is shown in figure 14.

A much more desirable and effective method of obtaining speech clipping is actually to employ a clipper circuit in the earlier stages of the speech amplifier, and then to filter out the objectionable distortion components by means of a sharp low-pass filter having a cut-off frequency of approximately 3000 cycles. Tests on *clipper-filter* speech systems have shown that 6 db of clipping on voice is just noticeable, 12 db of clipping is quite acceptable, and values of clipping from 20 to 25 db are tolerable under such conditions that a high degree of clipping is necessary to get through heavy QRM or QRN. A signal with 12 db of clipping doesn't sound quite *natural* but it is not unpleasant to listen to and is much more readable than an unclipped signal in the presence of strong interference.

The use of a clipper-filter in the speech amplifier, to be completely effective, requires that phase shift between the clipper-filter stage and the final modulated amplifier be kept

to a minimum. However, if there is phase shift after the clipper-filter the system does not completely break down. The presence of phase shift merely requires that the audio gain following the clipper-filter be reduced to the point where the *cant* applied to the clipped speech waves still cannot cause overmodulation. This effect is illustrated in figures 15 and 16.

The *cant* appearing on the tops of the square waves leaving the clipper-filter centers about the clipping level. Hence, as the frequency being passed through the system is lowered, the amount by which the peak of the *canted* wave exceeds the clipping level is increased.

Phase Shift Correction In a normal transmitter having a moderate amount of phase shift the *cant* applied to the tops of the waves will cause overmodulation on frequencies below those for which the gain following the clipper-filter has been adjusted unless remedial steps have been taken. The following steps are advised:

- (1) Introduce *bass suppression* into the speech amplifier *ahead* of the clipper-filter.
- (2) *Improve* the low-frequency response characteristic insofar as it is possible in the

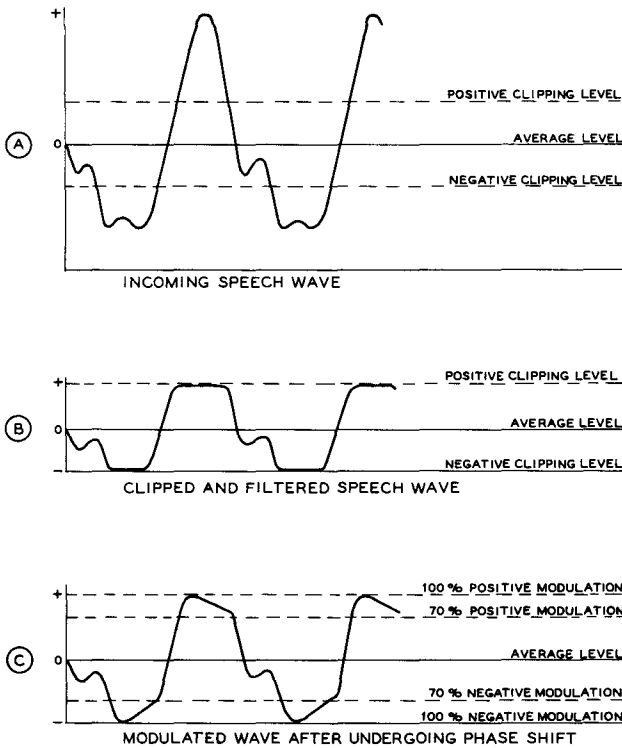

Figure 15
ACTION OF A CLIPPER-FILTER
ON A SPEECH WAVE

The drawing (A) shows the incoming speech wave before it reaches the clipper stage. (B) shows the output of the clipper-filter, illustrating the manner in which the peaks are clipped and then the sharp edges of the clipped wave removed by the filter. (C) shows the effect of phase shift in the stages following the clipper-filter. (C) also shows the manner in which the transmitter may be adjusted for 100 per cent modulation of the "canted" peaks of the wave, the sloping top of the wave reaching about 70 per cent modulation.

stages following the clipper-filter. Feeding the plate current to the final amplifier through a choke rather than through the secondary of the modulation transformer will help materially.

Even with the normal amount of improvement which can be attained through the steps mentioned above there will still be an amount of wave cant which must be compensated in some manner. This compensation can be done in either of two ways. The first and simpler way is as follows:

- (1) Adjust the speech gain *ahead* of the clipper-filter until with normal talking into the microphone the distortion being introduced by the clipper-filter circuit is quite apparent but not objectionable. This amount of distortion will be apparent to the normal listener when 10 to 15 db of clipping is taking place.
- (2) Tune a selective communications receiver about 15 kc. to one side or the other of the frequency being transmitted. Use a short antenna or no antenna at all on the receiver so that the transmitter is not blocking the receiver.

- (3) Again with the normal talking into the microphone adjust the gain following the clipper-filter to the point where the sideband splatter is being heard, and then slightly back off the gain after the clipper-filter until the splatter disappears.

If the phase shift in the transmitter or modulator is not excessive the adjustment procedure given above will allow a clean signal to be radiated regardless of any reasonable voice level being fed into the microphone.

If a cathode-ray oscilloscope is available the modulated envelope of the transmitter should be checked with 30 to 70 cycle sawtooth waves on the horizontal axis. If the upper half of the envelope appears in general the same as the drawing of figure 15C, all is well and phase-shift is not excessive. However, if much more slope appears on the tops of the waves than is illustrated in this figure, it will be well to apply the second step in compensation in order to insure that sideband splatter cannot take place and to afford a still higher average percentage of modulation. This second step consists of the addition of a high-level *splatter suppressor* such as is illustrated in figure 17.

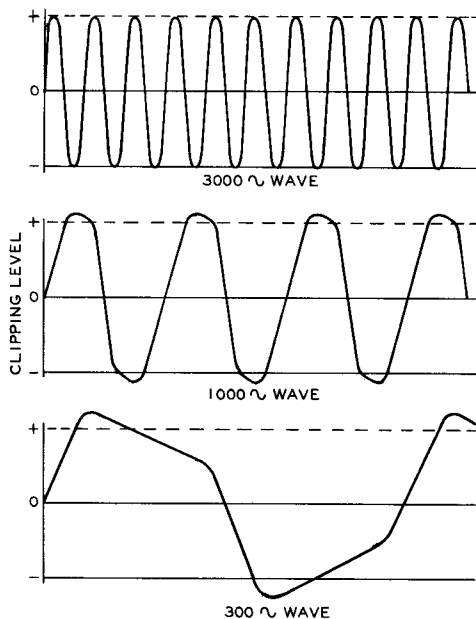

Figure 16

ILLUSTRATING THE EFFECT OF PHASE SHIFT AND FILTERED WAVES OF DIFFERENT FREQUENCY

Sketch (A) shows the effect of a clipper and a filter having a cutoff of about 3500 cycles on a wave of 3000 cycles. Note that no harmonics are present in the wave so that phase shift following the clipper-filter will have no significant effect on the shape of the wave. (B) and (C) show the effect of phase shift on waves well below the cutoff frequency of the filter. Note that the "cant" placed upon the top of the wave causes the peak value to rise higher and higher above the clipping level as the frequency is lowered. It is for this reason that bass suppression before the clipper stage is desirable. Improved low-frequency response following the clipper-filter will reduce the phase shift and therefore the canting of the wave at the lower voice frequencies.

The use of a high-level splatter suppressor after a clipper-filter system will afford the result shown in figure 18 since such a device will not permit the negative-peak clipping which the wave cant caused by audio-system phase shift can produce. The high-level splatter suppressor operates by virtue of the fact that it will not permit the plate voltage on the modulated amplifier to go completely to zero regardless of the incoming signal amplitude.

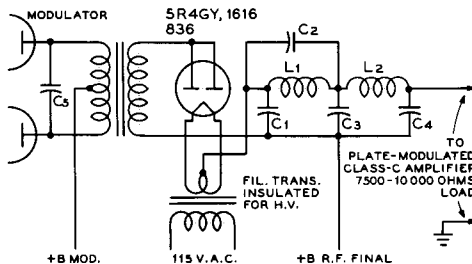

Figure 17

HIGH-LEVEL SPLATTER SUPPRESSOR

This circuit is effective in reducing splatter caused by negative-peak clipping in the modulated amplifier stage. The use of a two-section filter as shown is recommended, although either a single m-derived or a constant-k section may be used for greater economy. Suitable chokes, along with recommended capacitor values, are available from several manufacturers.

Hence negative-peak clipping with its attendant splatter cannot take place. Such a device can, of course, also be used in a transmitter which does not incorporate a clipper-filter system. However, the full increase in average modulation level without serious distortion, afforded by the clipper-filter system, will not be obtained.

A word of caution should be noted at this time in the case of tetrode final modulated amplifier stages which afford screen voltage modulation by virtue of a tap or a separate winding on the modulation transformer such as is shown in figure 9C of this chapter. If such a system of modulation is in use, the high-level splatter suppressor shown in figure 17 will not operate satisfactorily since negative-peak clipping in the stage can take place when the screen voltage goes too low.

Clipper Circuits Two effective low-level clipper-filter circuits are shown in figures 19 and 20. The circuit of figure 19 employs a 6J6 double triode as a clipper, each half of the 6J6 clipping one side of the impressed waveform. The optimum level at which the clipping operation begins is set by the value of the cathode resistor. A maximum of 12 to 14 db of clipping may be used with this circuit, which means that an extra 12 to 14 db of speech gain must precede the clipper. For a peak output of 8 volts from the clipper-filter, a peak audio signal of about 40 volts must be impressed upon the clipper input circuit. The 6C4 speech amplifier stage must therefore be considered as a part of the clipper circuit as

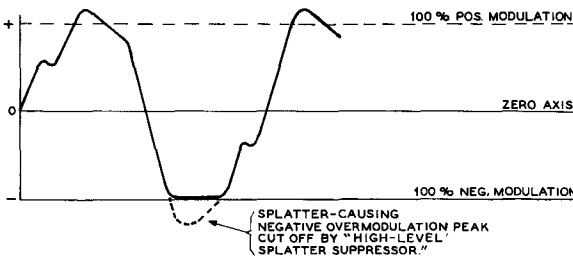

Figure 18

ACTION OF HIGH-LEVEL SPLATTER SUPPRESSOR

A high-level splatter suppressor may be used in a transmitter without a clipper-filter to reduce negative-peak clipping, or such a unit may be used following a clipper-filter to allow a higher average modulation level by eliminating the negative-peak clipping which the wave-cant caused by phase shift might produce.

it compensates for the 12 to 14 db loss of gain incurred in the clipping process. A simple low-pass filter made up of a 20 henry a.c. - d.c replacement type filter choke and two mica condensers follows the 6J6 clipper. This filter is designed for a cutoff frequency of about 3500 cycles when operating into a load impedance of 1/2 megohm. The output level of 8 volts peak is ample to drive a triode speech amplifier stage, such as a 6C4 or 6J5.

A 6AL5 double diode series clipper is employed in the circuit of figure 20, and a commercially made low-pass filter is used to give somewhat better high frequency cutoff characteristics. A double triode is employed as a speech amplifier ahead of the clipper circuit. The actual performance of either circuit is about the same.

To eliminate higher order products that may be generated in the stages following the clipper-filter, it is wise to follow the modulator with a high-level filter, as shown in figure 21.

Clipper Adjustment These clipper circuits have two adjustments: *Adjust Gain* and *Adjust Clipping*. The *Adj. Gain* control determines the modulation level of the transmitter. This control should be set

so that over-modulation of the transmitter is impossible, regardless of the amount of clipping used. Once the *Adj. Gain* control has been roughly set, the *Adj. Clip.* control may be used to set the modulation level to any percentage below 100%. As the modulation level is decreased, more and more clipping is introduced into the circuit, until a full 12 db of clipping is used. This means that the *Adj. Gain* control may be advanced some 12 db past the point where the clipping action started. Clipping action should start at 85% to 90% modulation when a sine wave is used for circuit adjustment purposes.

High-Level Filters Even though we may have cut off all frequencies above 3000 or 3500 cycles through the use of a filter system such as is shown in the circuits of figures 19 and 20, higher frequencies may again be introduced into the modulated wave by distortion in stages following the speech amplifier. Harmonics of the incoming audio frequencies may be generated in the driver stage for the modulator; they may be generated in the plate circuit of the modulator; or they may be generated by non-linearity in the modulated amplifier itself.

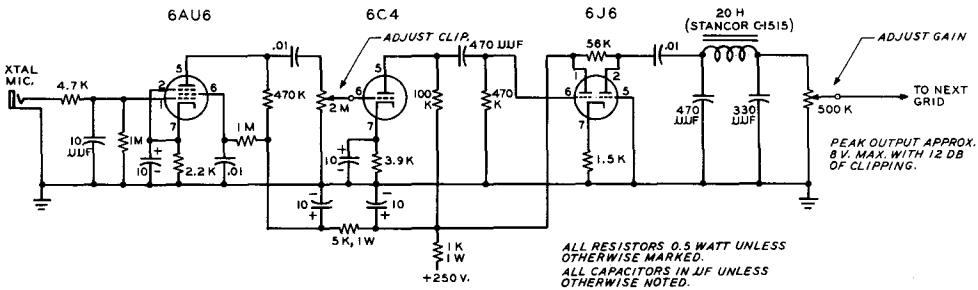

Figure 19

CLIPPER FILTER USING 6J6 DOUBLE TRIODE STAGE

PEAK OUTPUT APPROX. 8 V. MAX. WITH 12 DB OF CLIPPING.

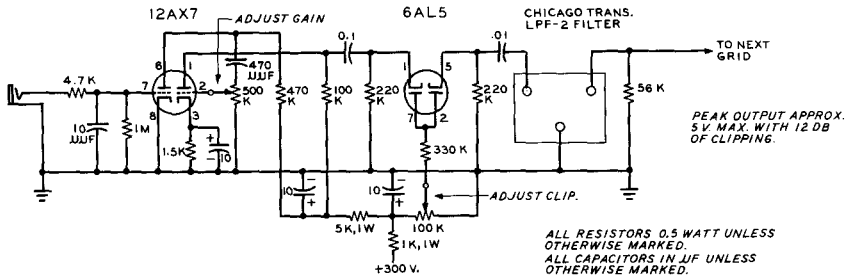

Figure 20
CLIPPER FILTER USING 6AL5 STAGE

Regardless of the point in the system following the speech amplifier where the high audio frequencies may be generated, these frequencies can still cause a broad signal to be transmitted even though all frequencies above 3000 or 3500 cycles have been cut off in the speech amplifier. The effects of distortion in the audio system following the speech amplifier can be eliminated quite effectively through the use of a *post-modulator* filter. Such a filter must be used between the modulator plate circuit and the r-f amplifier which is being modulated.

This filter may take three general forms in a normal case of a Class C amplifier plate modulated by a Class B modulator. The best method is to use a high level low-pass filter as

shown in figure 21 and discussed previously. Another method which will give excellent results in some cases and poor results in others, dependent upon the characteristics of the modulation transformer, is to "build out" the modulation transformer into a filter section. This is accomplished as shown in figure 22 by placing mica capacitors of the correct value across the primary and secondary of the modulation transformer. The proper values for the capaci-

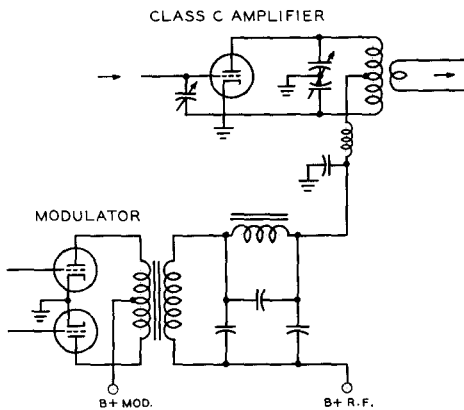

Figure 21
ADDITIONAL HIGH-LEVEL LOW-PASS FILTER TO FOLLOW MODULATOR WHEN A LOW-LEVEL CLIPPER FILTER IS USED
Suitable choke, along with recommended capacitor values, is available from several manufacturers.

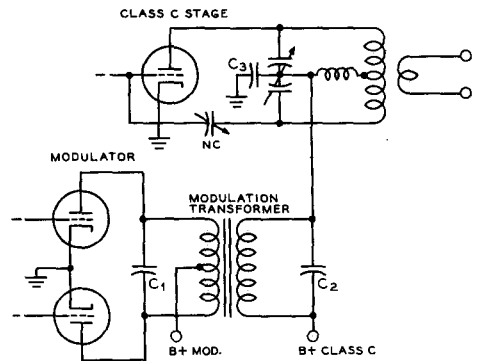

Figure 22
"BUILDING-OUT" THE MODULATION TRANSFORMER

This expedient utilizes the leakage reactance of the modulation transformer in conjunction with the capacitors shown to make up a single-section low-pass filter. In order to determine exact values for C_1 and C_2 plus C_3 , it is necessary to use a measurement setup such as is shown in figure 23. However, experiment has shown in the case of a number of commercially available modulation transformers that a value for C_1 of 0.002- μ fd. and C_2 plus C_3 of 0.004- μ fd. will give satisfactory results.

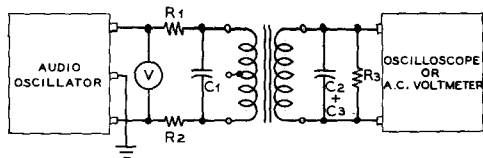

Figure 23
TEST SETUP FOR BUILDING-OUT
MODULATION TRANSFORMER

Through the use of a test setup such as is shown and the method described in the text it is possible to determine the correct values for a specified filter characteristic in the built-out modulation transformer.

tors C_1 and C_2 must, in the ideal case, be determined by trial and error. Experiment with a number of modulators has shown, however, that if a 0.002 $\mu\text{fd.}$ capacitor is used for C_1 , and if the sum of C_2 and C_3 is made 0.004 $\mu\text{fd.}$ (0.002 $\mu\text{fd.}$ for C_2 and 0.002 for C_3) the ideal condition of cutoff above 3000 cycles will be approached in most cases with the "multiple-match" type of modulation transformer.

If it is desired to determine the optimum values of the capacitors across the transformer this can be determined in several ways, all of which require the use of a calibrated audio oscillator. One way is diagrammed in figure 23. The series resistors R_1 and R_2 should each be equal to $\frac{1}{2}$ the value of the recommended plate-to-plate load resistance for the Class B modulator tubes. Resistor R_3 should be equal to the value of load resistance which the Class C modulated stage will present to the modulator. The meter V can be any type of a-c voltmeter. The indicating instrument on the secondary of the transformer can be either a cathode-ray oscilloscope or a high-impedance a-c voltmeter of the vacuum-tube or rectifier type.

With a set-up as shown in figure 23 a plot of output voltage against frequency is made, at all times keeping the voltage across V constant, using various values of capacitance for C_1 and C_2 plus C_3 . When the proper values of capacitance have been determined which give substantially constant output up to about 3000 or 3500 cycles and decreasing output at all frequencies above, high-voltage mica capacitors can be substituted if receiving types were used in the tests and the transformer connected to the modulator and Class C amplifier.

With the transformer reconnected in the transmitter a check of the modulated-wave output of the transmitter should be made using an audio oscillator as signal generator and an oscilloscope coupled to the transmitter output. With an input signal amplitude fed to the speech

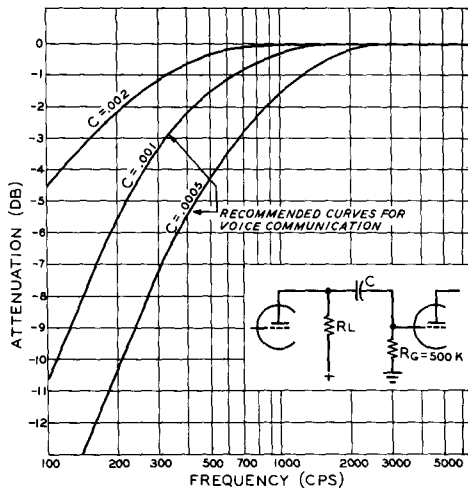

Figure 24
BASE ATTENUATION CHART

Frequency attenuation caused by various values of coupling capacitor with a grid resistor of 0.5 megohm in the following stage ($R_G > R_L$)

amplifier of such amplitude that limiting does not take place, a substantially clean sine wave should be obtained on the carrier of the transmitter at all input frequencies up to the cutoff frequency of the filter system in the speech amplifier and of the filter which includes the modulation transformer. Above these cutoff frequencies very little modulation of the carrier wave should be obtained. To obtain a check on the effectiveness of the "built out" modulation transformer, the capacitors across the primary and secondary should be removed for the test. In most cases a marked deterioration in the waveform output of the modulator will be noticed with frequencies in the voice range from 500 to 1500 cycles being fed into the speech amplifier.

A filter system similar to that shown in figure 17 may be used between the modulator and the modulated circuit in a grid-modulated or screen-modulated transmitter. Lower-voltage capacitors and low-current chokes may of course be employed.

Bass Suppression Most of the power represented by ordinary speech (particularly the male voice) lies below 1000 cycles. If all frequencies below 400 or 500 cycles are eliminated or substantially attenuated, there is a considerable reduction in power but insignificant reduction in intelligi-

bility. This means that the speech level may be increased considerably without overmodulation or overload of the audio system. In addition, if speech clipping is used, attenuation of the lower audio frequencies before the clipper will reduce phase shift and canting of the clipper output.

A simple method of bass suppression is to reduce the size of the interstage coupling capacitors in a resistance coupled amplifier. Figure 24 shows the frequency characteristics caused by such a suppression circuit. A second simple bass suppression circuit is to place a small a.c. - d.c. type filter choke from grid to ground in a speech amplifier stage, as shown in figure 25.

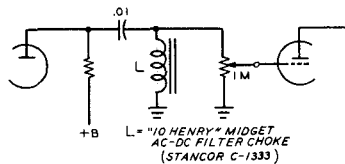

Figure 25
USE OF PARALLEL INDUCTANCE FOR BASS SUPPRESSION

Modulated Amplifier Distortion The systems described in the preceding paragraphs will have no effect in reducing a broad signal caused by non-linearity in the modulated amplifier. Even though the modulating waveform impressed upon the modulated stage may be distortion free, if the modulated amplifier is non-linear distortion will be generated in the amplifier. The only way in which this type of distortion may be corrected is by making the modulated amplifier more linear. Degenerative feedback which includes the modulated amplifier in the loop will help in this regard.

Plenty of grid excitation and high grid bias will go a long way toward making a plate-modulated Class C amplifier linear, although such operating conditions will make more difficult the problem of TVI reduction. If this still does not give adequate linearity, the preceding buffer stage may be modulated 50 per cent or so at the same time and in the same phase as the final amplifier. The use of a grid leak to obtain the majority of the bias for a Class C stage will improve its linearity.

The linearity of a grid-bias modulated r-f amplifier can be improved, after proper adjustments of excitation, grid bias, and antenna coupling have been made by modulating the stage which excites the grid-modulated amplifier. The preceding driver stage may be grid-bias modulated or it may be plate modulated. Modulation of the driver stage should be in the same phase as that of the final modulated amplifier.

15-8 The Bias-Shift Heising Modulator

The simple Class A modulator is limited to an efficiency of about 30%, and the tube must dissipate the full power input during periods of quiescence. Class AB and class B audio systems have largely taken the place of the old Heising modulator because of this great

waste of power. It is possible, however, to vary the operating bias of the class A modulator in such a way as to allow class A operation only when an audio signal is applied to the grid of the tube. During resting periods, the bias can be shifted to a higher value, dropping the resting plate current and plate dissipation of the tube. When voice waveforms having low average power are employed, the efficiency of the system is comparable to the popular class B modulator.

The characteristic curve for a class A modulator is shown in figure 26. Normal bias is used, and the operating point is placed in the middle of the linear portion of the E_g-I_p curve. Maximum plate input is limited by the plate dissipation of the tube under quiescent condition. The *bias-shift* modulator is biased close to plate current cut-off under no signal condition (figure 27). Resting plate current

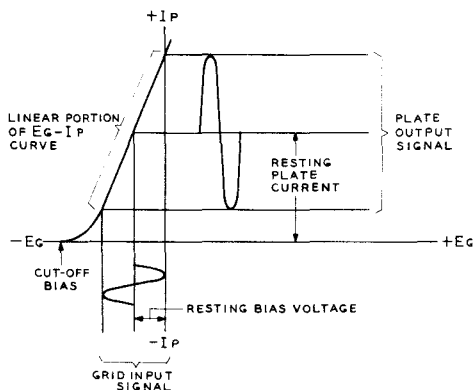

Figure 26
CHARACTERISTIC GRID VOLTAGE-PLATE CURRENT CURVE FOR CLASS A HEISING MODULATOR

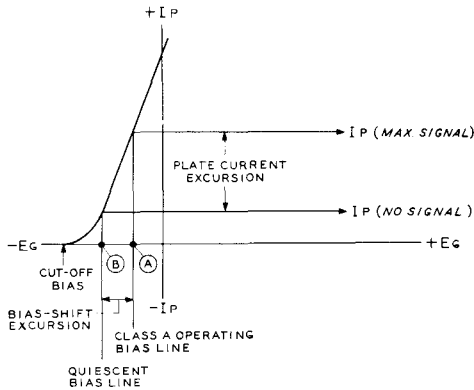

Figure 27
BIAS-SHIFT MODULATOR
OPERATING CHARACTERISTICS

Modulator is biased close to plate current cut-off under no signal, condition, B. Upon application of audio signal, the bias of the stage is shifted toward the class A operating point, A. Bias-shift voltage is obtained from audio signal.

and plate dissipation are therefore quite low. Upon application of an audio signal, the bias of the stage is shifted toward the class A operating point, preventing the negative peaks of the applied audio voltage from cutting off the plate current of the tube. As the audio voltage increases, the operating bias point is shifted to the right on figure 27 until the class A operating point is reached at maximum excitation.

The bias-shift voltage may be obtained directly from the exciting signal by rectification, as shown in figure 28. A simple low pass filter system is used that will pass only the syllabic components of speech. Enough negative bias is applied to the bias-shift modulator to cut the resting plate current to the desired value, and the output of the bias control rectifier is polarized so as to "buck" the fixed bias voltage. No spurious modulation frequencies are generated, since the modulator operates class A throughout the audio cycle.

This form of grid pulsing permits the modulator stage to work with an overall efficiency of greater than 50%, comparing favorably with the class B modulator. The expensive class B driver and output transformers are not required, since resistance coupling may be used in the input circuit of the bias-shift modulator, and

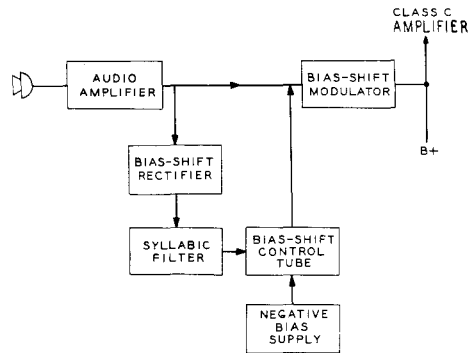

Figure 28
BLOCK DIAGRAM OF
BIAS-SHIFT MODULATOR

a heavy-duty filter choke will serve as an impedance coupler for the modulated stage.

Series and Parallel Control Circuits The bias-shift system make take one of several forms. A "series" control

circuit is shown in figure 29. Resting bias is applied to the bias-shift modulator tube through the voltage divider R2/R4. The bias control tube is placed across resistor R2. Quiescent bias for the modulator is set by adjusting R2. As the internal resistance of the bias control tube is varied at a syllabic rate the voltage drop across R2 will vary in unison. The modulator bias, therefore varies at the same rate. Excitation for the bias control tube is obtained from the audio signal through potentiometer R1 which regulates the amplitude of the control signal. The audio signal is rectified by the bias control rectifier, and filtered by network R3-C1 in the grid circuit of the bias control tube.

The "parallel" control system is illustrated in figure 30. Resting bias for the modulator is obtained from the voltage divider R2/R4. Potentiometer R2 adjusts the resting bias level, determining the static plate current of the modulator. Resistor R3 serves as a bias resistor for the control tube, reducing its plate current to a low level. When an audio signal is applied via R1 to the grid of the control tube the internal resistance is lowered, decreasing the shunt resistance across R2. The negative modulator bias is therefore reduced. The bias axis of the modulator is shifted from the cut-off region to a point on the linear portion of the operating curve. The amount of bias-shift is controlled by the setting of potentiometer R1. Capacitor C1 in conjunction with bias resistor R3 form a syllabic filter for

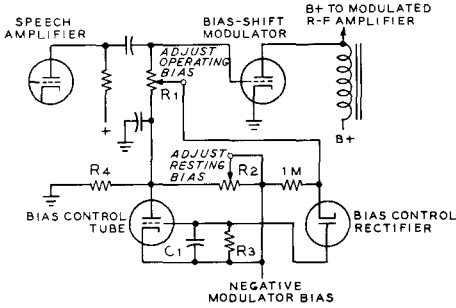

Figure 29
"SERIES" CONTROL CIRCUIT
FOR BIAS-SHIFT MODULATOR

The internal resistance of the bias control tube is varied at a syllabic rate to change the operating bias of the modulator tube.

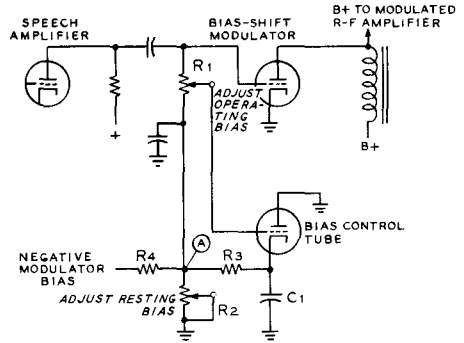

Figure 30
"PARALLEL" CONTROL
CIRCUIT FOR BIAS-SHIFT
MODULATOR

The resistance to ground of point A in the bias network is varied at a syllabic rate by the bias control tube.

the control bias that is applied to the modulator stage.

A large value of plate dissipation is required for the bias-shift modulator tube. For plate voltages below 1500, the 211 (VT-4C) may be used, while the 304-TL is suitable for voltages up to 3000. As with normal class A amplifiers, low μ tubes function best in this circuit.

A High-Level Bias-Shift Modulator

Shown in figure 31 is a bias-shift modulator employing two 304-TL tubes in parallel, operating from a 2500 volt plate supply. This modulator is capable of modulating 1000 watts input to an r-f amplifier. Modulator resting current is adjusted to about 40 milliamperes, rising to about 350 milliamperes on voice peaks. Plate power requirements are approximately the same as a conventional class B modulator. The class C r-f amplifier is adjusted to draw 400 milliamperes at 2500 volts.

Two stages of resistance coupled speech amplification are employed, permitting the use of a high gain crystal microphone. The 6J5 stage is transformer coupled to the parallel connected 304-TL tubes. Audio voltage to drive the control tubes is taken from the secondary of the 6J5 coupling transformer. A dual 6SN7 triode is employed as the control

rectifier and the control tube. A negative bias supply of approximately -430 volts is required to reduce the plate current of the 304-TL tubes to the proper value. The actual bias at the grid of the 304-TL's is -280 volts.

A separate filament supply is required for the 6SN7 control tube in order to remain within the manufacturer's recommended heater-cathode breakdown voltage. The filament of this tube is therefore connected to the bias line, rather than being grounded as are the filaments of the other 6.3 volt tubes.

The resting bias potentiometer is adjusted for the proper quiescent bias of the 304-TL tubes, determined by the static plate current level, and the audio bias control is then advanced until the operating bias of the modulators drops to approximately -210 volts under conditions of 100% modulation. Since the modulator tube and the r-f amplifier tube operate at the same plate voltage, it will not be possible to actually reach 100% modulation, but an average peak level of over 90% may easily be obtained.

A high level low-pass audio filter is placed after the modulator stage to reduce the higher harmonic components generated by the single-ended amplifiers.

E & E TECHNI-SHEET
DECIBEL CONVERSION CHART

DECIBELS	POWER RATIO	VOLTAGE AND CURRENT RATIO	DECIBELS	POWER RATIO	VOLTAGE AND CURRENT RATIO
0.1	1.023	1.012	13	19.953	4.467
0.2	1.047	1.023	14	25.119	5.012
0.3	1.071	1.035	15	31.623	5.623
0.4	1.096	1.047	16	39.811	6.310
0.5	1.122	1.059	17	50.119	7.079
0.6	1.148	1.072	18	63.096	7.943
0.7	1.175	1.084	19	79.433	8.913
0.8	1.202	1.097	20	100.000	10.000
0.9	1.230	1.109	22	158.49	12.589
1.0	1.259	1.122	24	251.19	15.849
1.2	1.318	1.148	26	388.11	19.953
1.4	1.380	1.175	28	630.96	25.119
1.6	1.445	1.202	30	1000.00	31.623
1.8	1.514	1.230	32	1584.9	39.811
2.0	1.585	1.259	34	2511.9	50.119
2.2	1.660	1.288	36	3981.1	63.096
2.4	1.738	1.318	38	6309.6	79.433
2.6	1.820	1.349	40	10000.0	100.000
2.8	1.906	1.380	42	1.585×10^4	125.89
3.0	1.995	1.412	44	2.512×10^4	158.49
3.5	2.239	1.496	46	3.981×10^4	199.53
4.0	2.512	1.585	48	6.310×10^4	251.19
4.5	2.818	1.679	50	10^5	316.23
5.0	3.162	1.778	52	1.585×10^5	398.11
5.5	3.548	1.884	54	2.512×10^5	501.19
6	3.981	1.995	56	3.981×10^5	630.96
7	5.012	2.239	58	6.310×10^5	794.33
8	6.310	2.512	60	10^6	1000.0
9	7.943	2.818	70	10^7	3162.3
10	10.000	3.162	80	10^8	10000.0
11	12.589	3.548	90	10^9	31623.0
12	15.849	3.981	100	10^{10}	100000.0

Frequency Modulation and Radioteletype Transmission

Exciter systems for FM and single sideband transmission are basically similar in that modification of the signal in accordance with the intelligence to be transmitted is normally accomplished at a relatively low level. Then the intelligence-bearing signal is amplified to the desired power level for ultimate transmission. True, amplifiers for the two types of signals are basically different; linear amplifiers of the Class A or Class B type being used for ssb signals, while Class C or non-linear Class B amplifiers may be used for FM amplification. But the principle of low-level generation and subsequent amplification is standard for both types of transmission.

16-1 Frequency Modulation

The use of frequency modulation and the allied system of phase modulation has become of increasing importance in recent years. For amateur communication frequency and phase modulation offer important advantages in the reduction of broadcast and TV interference and in the elimination of the costly high-level modulation equipment most commonly employed with amplitude modulation. For broadcast work FM offers an improvement in signal-to-noise ratio for the high field intensities available in the local-coverage area of FM and TV broadcast stations.

In this chapter various points of difference between FM and amplitude modulation transmission and reception will be discussed and

the advantages of FM for certain types of communication pointed out. Since the distinguishing features of the two types of transmission lie entirely in the modulating circuits at the transmitter and in the detector and limiter circuits in the receiver, these parts of the communication system will receive the major portion of attention.

Modulation *Modulation* is the process of altering a radio wave in accordance with the intelligence to be transmitted. The nature of the intelligence is of little importance as far as the process of modulation is concerned; it is the *method* by which this intelligence is made to give a distinguishing characteristic to the radio wave which will enable the receiver to convert it back into intelligence that determines the type of modulation being used.

Figure 1 is a drawing of an r-f carrier amplitude modulated by a sine-wave audio voltage. After modulation the resultant modulated r-f wave is seen still to vary about the zero axis at a constant rate, but the strength of the individual r-f cycles is proportional to the amplitude of the modulation voltage.

In figure 2, the carrier of figure 1 is shown frequency modulated by the same modulating voltage. Here it may be seen that modulation voltage of one polarity causes the carrier frequency to decrease, as shown by the fact that the individual r-f cycles of the carrier are spaced farther apart. A modulating voltage of the opposite polarity causes the frequency to

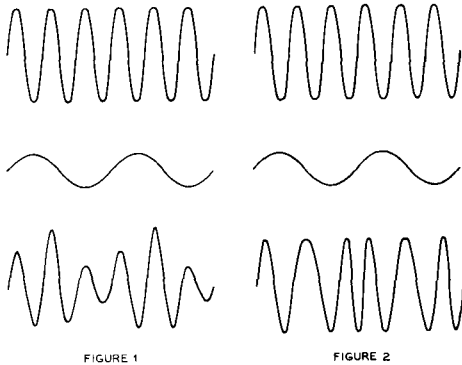

AM AND FM WAVES

Figure 1 shows a sketch of the scope pattern of an amplitude modulated wave at the bottom. The center sketch shows the modulating wave and the upper sketch shows the carrier wave.

Figure 2 shows at the bottom a sketch of a frequency modulated wave. In this case the center sketch also shows the modulating wave and the upper sketch shows the carrier wave. Note that the carrier wave and the modulating wave are the same in either case, but that the waveform of the modulated wave is quite different in the two cases.

increase, and this is shown by the r-f cycles being squeezed together to allow more of them to be completed in a given time interval.

Figures 1 and 2 reveal two very important characteristics about amplitude- and frequency-modulated waves. First, it is seen that while the amplitude (power) of the signal is varied in AM transmission, no such variation takes place in FM. In many cases this advantage of FM is probably of equal or greater importance than the widely publicized noise reduction capabilities of the system. When 100 per cent amplitude modulation is obtained, the average power output of the transmitter must be increased by 50 per cent. This additional output must be supplied either by the modulator itself, in the high-level system, or by operating one or more of the transmitter stages at such a low output level that they are capable of producing the additional output without distortion, in the low-level system. On the other hand, a frequency-modulated transmitter requires an insignificant amount of power from the modulator and needs no provision for increased power output on modulation peaks. All of the stages between the oscillator and the antenna may be operated as high-efficiency Class B or Class C amplifiers or frequency multipliers.

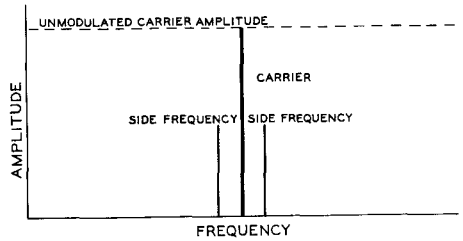

Figure 3
AM SIDE FREQUENCIES

For each AM modulating frequency, a pair of side frequencies is produced. The side frequencies are spaced away from the carrier by an amount equal to the modulation frequency, and their amplitude is directly proportional to the amplitude of the modulation. The amplitude of the carrier does not change under modulation.

Carrier-Wave Distortion and AM waves revealed by figures 1 and 2 is that both types

of modulation result in distortion of the r-f carrier. That is, after modulation, the r-f cycles are no longer sine waves, as they would be if no frequencies other than the fundamental carrier frequency were present. It may be shown in the amplitude modulation case illustrated, that there are only two additional frequencies present, and these are the familiar *side frequencies*, one located on each side of the carrier, and each spaced from the carrier by a frequency interval equal to the modulation frequency. In regard to frequency and amplitude, the situation is as shown in figure 3. The strength of the carrier itself does not vary during modulation, but the strength of the side frequencies depends upon the percentage of modulation. At 100 per cent modulation the power in the side frequencies is equal to half that of the carrier.

Under frequency modulation, the carrier wave again becomes distorted, as shown in figure 2. But, in this case, many more than two additional frequencies are formed. The first two of these frequencies are spaced from the carrier by the modulation frequency, and the additional side frequencies are located out on each side of the carrier and are also spaced from each other by an amount equal to the modulation frequency. Theoretically, there are an infinite number of side frequencies formed, but, fortunately, the strength of those beyond the frequency *swing* of the transmitter under modulation is relatively low.

One set of side frequencies that might be formed by frequency modulation is shown in figure 4. Unlike amplitude modulation, the

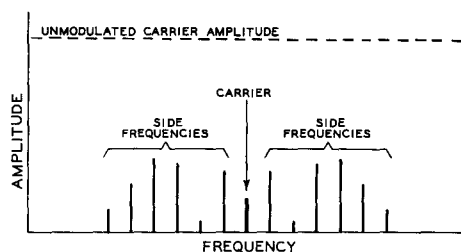

Figure 4
FM SIDE FREQUENCIES

With FM each modulation frequency component causes a large number of side frequencies to be produced. The side frequencies are separated from each other and the carrier by an amount equal to the modulation frequency, but their amplitude varies greatly as the amount of modulation is changed. The carrier strength also varies greatly with frequency modulation. The side frequencies shown represent a case where the deviation each side of the "carrier" frequency is equal to five times the modulating frequency. Other amounts of deviation with the same modulating frequency would cause the relative strengths of the various sidebands to change widely.

strength of the component at the carrier frequency varies widely in FM and it may even disappear entirely under certain conditions. The variation of strength of the carrier component is useful in measuring the amount of frequency modulation, and will be discussed in detail later in this chapter.

One of the great advantages of FM over AM is the reduction in noise at the receiver which the system allows. If the receiver is made responsive only to changes in frequency, a considerable increase in signal-to-noise ratio is made possible through the use of FM, when the signal is of greater strength than the noise. The noise reducing capabilities of FM arise from the inability of noise to cause appreciable frequency modulation of the noise-plus-signal voltage which is applied to the detector in the receiver.

FM Terms Unlike amplitude modulation, the term *percentage modulation* means little in FM practice, unless the receiver characteristics are specified. There are, however, three terms, *deviation*, *modulation index*, and *deviation ratio*, which convey considerable information concerning the character of the FM wave.

Deviation is the amount of frequency shift each side of the unmodulated carrier frequency which occurs when the transmitter is modulated. Deviation is ordinarily measured in kilocycles, and in a properly operating FM trans-

mitter it will be directly proportional to the amplitude of the modulating signal. When a symmetrical modulating signal is applied to the transmitter, equal deviation each side of the resting frequency is obtained during each cycle of the modulating signal, and the total frequency range covered by the FM transmitter is sometimes known as the *swing*. If, for instance, a transmitter operating on 1000 kc. has its frequency shifted from 1000 kc. to 1010 kc., back to 1000 kc., then to 990 kc., and again back to 1000 kc. during one cycle of the modulating wave, the *deviation* would be 10 kc. and the *swing* 20 kc.

The *modulation index* of an FM signal is the ratio of the deviation to the audio modulating frequency, when both are expressed in the same units. Thus, in the example above if the signal is varied from 1000 kc. to 1010 kc. to 990 kc., and back to 1000 kc. at a rate (frequency) of 2000 times, a second, the modulation index would be 5, since the deviation (10 kc.) is 5 times the modulating frequency (2000 cycles, or 2 kc.).

The relative strengths of the FM carrier and the various side frequencies depend directly upon the modulation index, these relative strengths varying widely as the modulation index is varied. In the preceding example, for instance, side frequencies occur on the high side of 1000 kc. at 1002, 1004, 1006, 1008, 1010, 1012, etc., and on the low frequency side at 998, 996, 994, 992, 990, 988, etc. In proportion to the unmodulated carrier strength (100 per cent), these side frequencies have the following strengths, as indicated by a modulation index of 5: 1002 and 998—33 per cent, 1004 and 996—5 per cent, 1006 and 994—36 per cent, 1008 and 992—39 per cent, 1010 and 990—26 per cent, 1012 and 988—13 per cent. The carrier strength (1000 kc.) will be 18 per cent of its unmodulated value. Changing the amplitude of the modulating signal will change the deviation, and thus the modulation index will be changed, with the result that the side frequencies, while still located in the same places, will have different strength values from those given above.

The *deviation ratio* is similar to the modulation index in that it involves the ratio between a modulating frequency and deviation. In this case, however, the deviation in question is the peak frequency shift obtained under full modulation, and the audio frequency to be considered is the maximum audio frequency to be transmitted. When the maximum audio frequency to be transmitted is 5000 cycles, for example, a deviation ratio of 3 would call for a peak deviation of 3×5000 , or 15 kc. at full modulation. The noise-suppression capabilities of FM are directly related to the deviation ratio. As the deviation ratio is increased,

the noise suppression becomes better *if* the signal is somewhat stronger than the noise. Where the noise approaches the signal in strength, however, low deviation ratios allow communication to be maintained in many cases where high-deviation-ratio FM and conventional AM are incapable of giving service. This assumes that a narrow-band FM receiver is in use. For each value of r-f signal-to-noise ratio at the receiver, there is a maximum deviation ratio which may be used, beyond which the output audio signal-to-noise ratio decreases. Up to this critical deviation ratio, however, the noise suppression becomes progressively better as the deviation ratio is increased.

For high-fidelity FM broadcasting purposes, a deviation ratio of 5 is ordinarily used, the maximum audio frequency being 15,000 cycles, and the peak deviation at full modulation being 75 kc. Since a swing of 150 kc. is covered by the transmitter, it is obvious that wide-band FM transmission must necessarily be confined to the v-h-f range or higher, where room for the signals is available.

In the case of television sound, the deviation ratio is 1.67; the maximum modulation frequency is 15,000 cycles, and the transmitter deviation for full modulation is 25 kc. The sound carrier frequency in a standard TV signal is located exactly 4.5 Mc. higher than the picture carrier frequency. In the *inter-carrier* TV sound system, which recently has become quite widely used, this constant difference between the picture carrier and the sound carrier is employed within the receiver to obtain an FM sub-carrier at 4.5 Mc. This 4.5 Mc. sub-carrier then is demodulated by the FM detector to obtain the sound signal which accompanies the picture.

Narrow-Band FM Transmission Narrow-band FM transmission has become standardized for use by the mobile services such as police, fire, and taxicab communication, and also on the basis of a temporary authorization for amateur work in portions of each of the amateur radiotelephone bands. A maximum deviation of 15 kc. has been standardized for the mobile and commercial communication services, while a maximum deviation of 3 kc. is authorized for amateur NBFM communication.

Bandwidth Required by FM As the above discussion has indicated, many side frequencies are set up when a radio-frequency carrier is frequency modulated; theoretically, in fact, an infinite number of side frequencies is formed. Fortunately, however, the amplitudes of those side frequencies falling outside the frequency range over which

the transmitter is *swung* are so small that most of them may be ignored. In FM transmission, when a complex modulating wave (speech or music) is used, still additional side frequencies resulting from a beating together of the various frequency components in the modulating wave are formed. This is a situation that does not occur in amplitude modulation and it might be thought that the large number of side frequencies thus formed might make the frequency spectrum produced by an FM transmitter prohibitively wide. Analysis shows, however, that the additional side frequencies are of very small amplitude, and, instead of increasing the bandwidth, modulation by a complex wave actually reduces the effective bandwidth of the FM wave. This is especially true when speech modulation is used, since most of the power in voiced sounds is concentrated at low frequencies in the vicinity of 400 cycles.

The bandwidth required in an FM receiver is a function of a number of factors, both theoretical and practical. Basically, the bandwidth required is a function of the deviation ratio and the maximum frequency of modulation, although the practical consideration of drift and ease of receiver tuning also must be considered. Shown in figure 5 are the frequency spectra (carrier and sideband frequencies) associated with the standard FM broadcast signal, the TV sound signal, and an amateur-band narrow-band FM signal with full modulation using the highest permissible modulating frequency in each case. It will be seen that for low deviation ratios the receiver bandwidth should be at least four times the maximum frequency deviation, but for a deviation ratio of 5 the receiver bandwidth need be only about 2.5 times the maximum frequency deviation.

16-2 Direct FM Circuits

Frequency modulation may be obtained either by the direct method, in which the frequency of an oscillator is changed directly by the modulating signal, or by the indirect method which makes use of phase modulation. Phase-modulation circuits will be discussed in section 16-3.

A successful frequency modulated transmitter must meet two requirements: (1) The frequency deviation must be symmetrical about a fixed frequency, for symmetrical modulation voltage. (2) The deviation must be directly proportional to the amplitude of the modulation, and independent of the modulation frequency. There are several methods of direct frequency modulation which will fulfill these

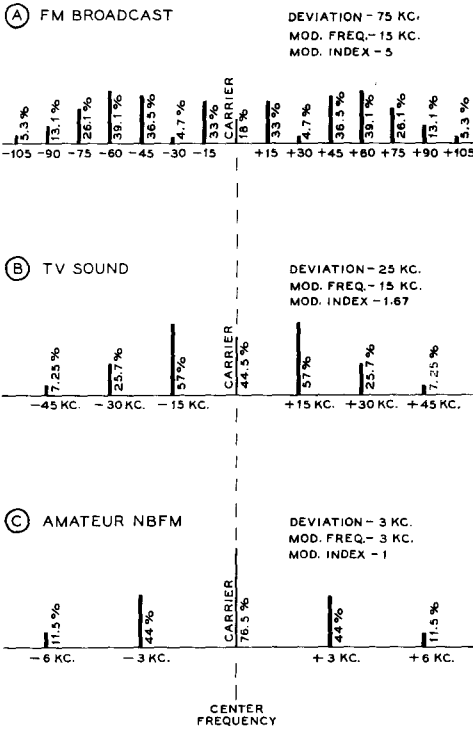

Figure 5
EFFECT OF FM MODULATION INDEX

Showing the side-frequency amplitude and distribution for the three most common modulation indices used in FM work. The maximum modulating frequency and maximum deviation are shown in each case.

requirements. Some of these methods will be described in the following paragraphs.

Reactance-Tube Modulators One of the most practical ways of obtaining direct frequency modulation is through the use of a *reactance-tube modulator*. In this arrangement the modulator plate-cathode circuit is connected across the oscillator tank circuit, and made to appear as either a capacitive or inductive reactance by exciting the modulator grid with a voltage which either leads or lags the oscillator tank voltage by 90 degrees. The leading or lagging grid voltage causes a corresponding leading or lagging plate current, and the plate-cathode circuit appears as a capacitive or inductive reactance across the oscillator tank circuit. When the transconductance of the modulator tube is varied, by varying one of the element voltages, the magnitude of the reactance across the os-

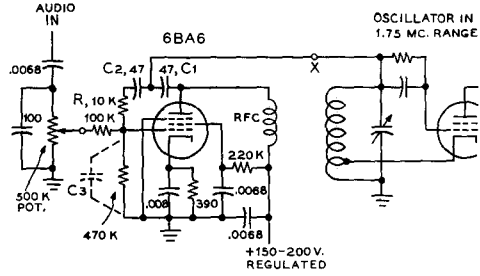

Figure 6
REACTANCE-TUBE MODULATOR

This circuit is convenient for direct frequency modulation of an oscillator in the 1.75-Mc. range. Capacitor C₃ may be only the input capacitance of the tube, or a small trimmer capacitor may be included to permit a variation in the sensitivity of the reactance tube.

cillator tank is varied. By applying audio modulating voltage to one of the elements, the transconductance, and hence the frequency, may be varied at an audio rate. When properly designed and operated, the reactance-tube modulator gives linear frequency modulation, and is capable of producing large amounts of deviation.

There are numerous possible configurations of the reactance-tube modulator circuit. The difference in the various arrangements lies principally in the type of phase-shifting circuit used to give a grid voltage which is in phase quadrature with the r-f voltage at the modulator plate.

Figure 6 is a diagram of one of the most popular forms of reactance-tube modulators. The modulator tube, which is usually a pentode such as a 6BA6, 6AU6, or 6CL6, has its plate coupled through a blocking capacitor, C₁, to the "hot" side of the oscillator grid circuit. Another blocking capacitor, C₂, feeds r.f. to the phase shifting network R-C₂ in the modulator grid circuit. If the resistance of R is made large in comparison with the reactance of C₂ at the oscillator frequency, the current through the R-C₂ combination will be nearly in phase with the voltage across the tank circuit, and the voltage across C₂ will lag the oscillator tank voltage by almost 90 degrees. The result of the 90-degree lagging voltage on the modulator grid is that its plate current lags the tank voltage by 90 degrees, and the reactance tube appears as an inductance in shunt with the oscillator inductance, thus raising the oscillator frequency.

The phase-shifting capacitor C₂ can consist of the input capacitance of the modulator tube and stray capacitance between grid and ground.

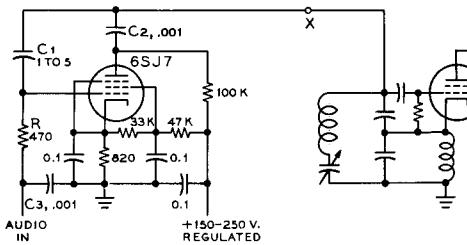

Figure 7
ALTERNATIVE REACTANCE-TUBE
MODULATOR

This circuit is often preferable for use in the lower frequency range, although it may be used at 1.75 Mc. and above if desired. In the schematic above the reactance tube is shown connected across the voltage-divider capacitors of a Clapp oscillator, although the modulator circuit may be used with any common type of oscillator.

However, better control of the operating conditions of the modulator may be had through the use of a variable capacitor as C_3 . Resistance R will usually have a value of between 4700 and 100,000 ohms. Either resistance or transformer coupling may be used to feed audio voltage to the modulator grid. When a resistance coupling is used, it is necessary to shield the grid circuit adequately, since the high impedance grid circuit is prone to pick up stray r-f and low frequency a-c voltage, and cause undesired frequency modulation.

An alternative reactance modulator circuit is shown in figure 7. The operating conditions are generally the same, except that the r-f excitation voltage to the grid of the reactance tube is obtained effectively through reversing the R and C_3 of figure 6. In this circuit a small capacitance is used to couple r.f. into the grid of the reactance tube, with a relatively small value of resistance from grid to ground. This circuit has the advantage that the grid of the tube is at relatively low impedance with respect to r.f. However, the circuit normally is not suitable for operation above a few megacycles due to the shunting capacitance within the tube from grid to ground.

Either of the reactance-tube circuits may be used with any of the common types of oscillators. The reactance modulator of figure 6 is shown connected to the high-impedance point of a conventional hot-cathode Hartley oscillator, while that of figure 7 is shown connected across the low-impedance capacitors of a series-tuned Clapp oscillator.

There are several possible variations of the basic reactance-tube modulator circuits shown

in figures 6 and 7. The audio input may be applied to the suppressor grid, rather than the control grid, if desired. Another modification is to apply the audio to a grid other than the control grid in a mixer or pentagrid converter tube which is used as the modulator. Generally, it will be found that the transconductance variation per volt of control-element voltage variation will be greatest when the control (audio) voltage is applied to the control grid. In cases where it is desirable to separate completely the audio and r-f circuits, however, applying audio voltage to one of the other elements will often be found advantageous despite the somewhat lower sensitivity.

Adjusting the Phase Shift One of the simplest methods of adjusting the phase shift to the correct amount is to place a pair of earphones in series with the oscillator cathode-to-ground circuit and adjust the phase-shift network until minimum sound is heard in the phones when frequency modulation is taking place. If an electron-coupled or Hartley oscillator is used, this method requires that the cathode circuit of the oscillator be inductively or capacitively coupled to the grid circuit, rather than tapped on the grid coil. The phones should be adequately bypassed for r.f. of course.

Stabilization Due to the presence of the reactance-tube frequency modulator, the stabilization of an FM oscillator in regard to voltage changes is considerably more involved than in the case of a simple self-controlled oscillator for transmitter frequency control. If desired, the oscillator itself may be made perfectly stable under voltage changes, but the presence of the frequency modulator destroys the beneficial effect of any such stabilization. It thus becomes desirable to apply the stabilizing arrangement to the modulator as well as the oscillator. If the oscillator itself is stable under voltage changes, it is only necessary to apply voltage-frequency compensation to the modulator.

Reactance-Tube Modulators Two simple reactance-tube modulators that may be applied to an existing v.f.o. are illustrated in figures 8 and 9. The circuit of figure 8 is extremely simple, yet effective. Only two tubes are used exclusive of the voltage regulator tubes which perhaps may be already incorporated in the v.f.o. A 6AU6 serves as a high-gain voltage amplifier stage, and a 6CL6 is used as the reactance modulator since its high value of transconductance will permit a large value of lagging current to be drawn under modulation swing. The unit should be

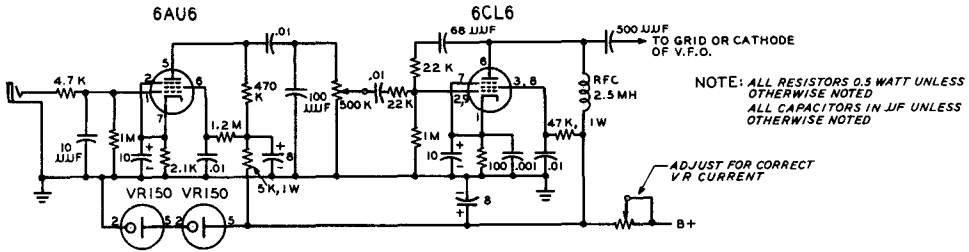

Figure 8
SIMPLE FM REACTANCE-TUBE MODULATOR

mounted in close proximity to the v.f.o. so that the lead from the 6CL6 to the grid circuit of the oscillator can be as short as possible. A practical solution is to mount the reactance modulator in a small box on the side of the v-f-o cabinet.

By incorporating speech clipping in the reactance modulator unit, a much more effective use is made of a given amount of deviation. When the FM signal is received on an AM receiver by means of slope detection, the use of speech clipping will be noticed by the greatly increased modulation level of the FM signal, and the attenuation of the center frequency null of no modulation. In many cases, it is difficult to tell a speech-clipped FM signal from the usual AM signal.

A more complex FM reactance modulator incorporating a speech clipper is shown in figure 9. A 12AX7 double triode speech amplifier provides enough gain for proper clipper action when a high level crystal microphone is used. A double diode 6AL5 speech clipper is used, the clipping level being set by the potentiometer controlling the plate voltage applied to the diode. A 6CL6 serves as the reactance modulator.

The reactance modulator may best be adjusted by listening to the signal of the v-f-o exciter at the operating frequency and adjusting the gain and clipping controls for the best modulation level consistent with minimum side-band splatter. Minimum clipping occurs when the *Adj. Clip.* potentiometer is set for maximum voltage on the plates of the 6AL5 clipper tube. As with the case of all reactance modulators, a voltage regulated plate supply is required.

Linearity Test It is almost a necessity to run a static test on the reactance-tube frequency modulator to determine its linearity and effectiveness, since small changes in the values of components, and in stray capacitances will almost certainly alter the modulator characteristics. A frequency-versus-control-voltage curve should be plotted to ascertain that equal increments in control voltage, both in a positive and a negative direction, cause equal changes in frequency. If the curve shows that the modulator has an appreciable amount of non-linearity, changes in bias, electrode voltages, r-f excitation, and resistance

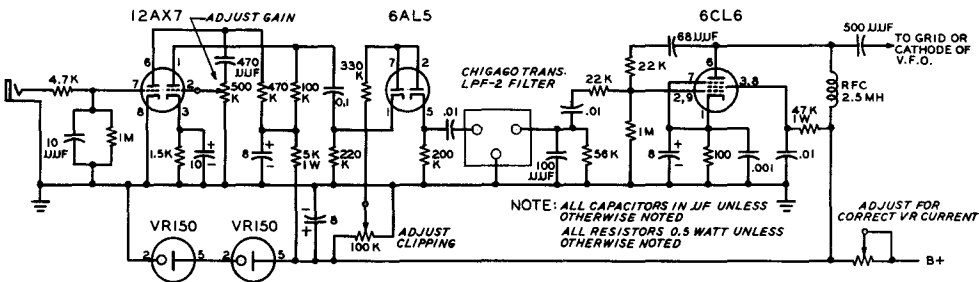

Figure 9
FM REACTANCE MODULATOR WITH SPEECH CLIPPER

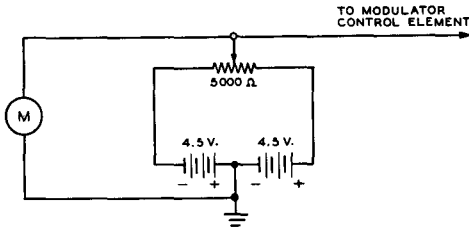

Figure 10
REACTANCE-TUBE LINEARITY CHECKER

values may be made to obtain a straight-line characteristic.

Figure 10 shows a method of connecting two $4\frac{1}{2}$ -volt C batteries and a potentiometer to plot the characteristic of the modulator. It will be necessary to use a zero-center voltmeter to measure the grid voltage, or else reverse the voltmeter leads when changing from positive to negative grid voltage. When a straight-line characteristic for the modulator is obtained by the static test method, the capacitances of the various by-pass capacitors in the circuit must be kept small to retain this characteristic when an audio voltage is used to vary the frequency in place of the d-c voltage with which the characteristic was plotted.

16-3 Phase Modulation

By means of phase modulation (PM) it is possible to dispense with self-controlled oscillators and to obtain directly crystal-controlled FM. In the final analysis, PM is simply frequency modulation in which the deviation is directly proportional to the modulation frequency. If an audio signal of 1000 cycles causes a deviation of $\frac{1}{2}$ kc., for example, a 2000-cycle modulating signal of the same amplitude will give a deviation of 1 kc., and so on. To produce an FM signal, it is necessary to make the deviation independent of the modulation frequency, and proportional only to the modulating signal. With PM this is done by including a frequency correcting network in the transmitter. The audio correction network must have an attenuation that varies directly with frequency, and this requirement is easily met by a very simple resistance-capacity network.

The only disadvantage of PM, as compared to direct FM such as is obtained through the use of a reactance-tube modulator, is the fact that very little frequency deviation is produced directly by the phase modulator. The deviation produced by a phase modulator is independent of the actual carrier frequency on

which the modulator operates, but is dependent only upon the phase deviation which is being produced and upon the modulation frequency. Expressed as an equation:

$$F_d = M_p \text{ modulating frequency}$$

Where F_d is the frequency deviation one way from the mean value of the carrier, and M_p is the phase deviation accompanying modulation expressed in radians (a radian is approximately 57.3°). Thus, to take an example, if the phase deviation is $\frac{1}{2}$ radian and the modulating frequency is 1000 cycles, the frequency deviation applied to the carrier being passed through the phase modulator will be 500 cycles.

It is easy to see that an enormous amount of multiplication of the carrier frequency is required in order to obtain from a phase modulator the frequency deviation of 75 kc. required for commercial FM broadcasting. However, for amateur and commercial narrow-band FM work (NBFM) only a quite reasonable number of multiplier stages are required to obtain a deviation ratio of approximately one. Actually, phase modulation of approximately one-half radian on the output of a crystal oscillator in the 80-meter band will give adequate deviation for 29-Mc. NBFM radiotelephony. For example; if the crystal frequency is 3700 kc., the deviation in phase produced is $\frac{1}{2}$ radian, and the modulating frequency is 500 cycles, the deviation in the 80-meter band will be 250 cycles. But when the crystal frequency is multiplied on up to 29,600 kc. the frequency deviation will also be multiplied by 8 so that the resulting deviation on the 10-meter band will be 2 kc. either side of the carrier for a total swing in carrier frequency of 4 kc. This amount of deviation is quite adequate for NBFM work.

Odd-harmonic distortion is produced when FM is obtained by the phase-modulation method, and the amount of this distortion that can be tolerated is the limiting factor in determining the amount of PM that can be used. Since the aforementioned frequency-correcting network causes the lowest modulating frequency to have the greatest amplitude, maximum phase modulation takes place at the lowest modulating frequency, and the amount of distortion that can be tolerated at this frequency determines the maximum deviation that can be obtained by the PM method. For high-fidelity broadcasting, the deviation produced by PM is limited to an amount equal to about one-third of the lowest modulating frequency. But for NBFM work the deviation may be as high as 0.6 of the modulating frequency before distortion becomes objectionable on voice modulation. In other terms this means that phase deviations as high as 0.6 radian may be used for amateur and commercial NBFM transmission.

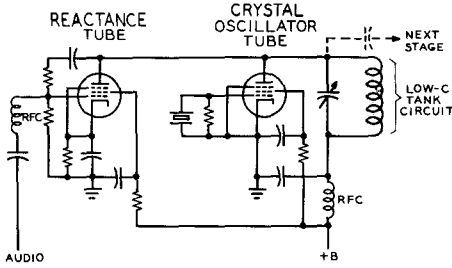

Figure 11
REACTANCE-TUBE MODULATION OF
CRYSTAL OSCILLATOR STAGE

Phase-Modulation Circuits A simple reactance modulator normally used for FM may also be used for PM by connecting it to the plate circuit of a crystal oscillator stage as shown in figure 11.

Another PM circuit, suitable for operation on 20, 15 and 10 meters with the use of 80 meter crystals is shown in figure 12. A double triode 12AX7 is used as a combination Pierce crystal oscillator and phase modulator. C_1 should not be thought of as a neutralizing condenser, but rather as an adjustment for the phase of the r-f voltage acting between the grid and plate of the 12AX7 phase modulator. C_2 acts as a phase angle and magnitude control, and both these condensers should be adjusted for maximum phase modulation capabilities of the circuit. Resonance of the circuit is established by the iron slug of coil L_1 - L_2 . A 6CL6 is used as a doubler to 7 Mc. and delivers approximately 2 watts on this band. Additional doubler stages may be added after the 6CL6 stage to reach the desired band of operation.

Still another PM circuit, which is quite widely used commercially, is shown in figure 13. In this circuit L and C are made resonant at a frequency which is 0.707 times the operating frequency. Hence at the operating frequency the inductive reactance is twice the capacitive reactance. A cathode follower tube acts as a variable resistance in series with the L and C which go to make up the tank circuit. The operating point of the cathode follower should be chosen so that the effective resistance in series with the tank circuit (made up of the resistance of the cathode-follower tube in parallel with the cathode bias resistor of the cathode follower) is equal to the capacitive reactance of the tank capacitor at the operating frequency. The circuit is capable of about plus or minus $\frac{1}{2}$ radian deviation with tolerable distortion.

Measurement of Deviation When a single-frequency modulating voltage is used with an

FM transmitter, the relative amplitudes of the various sidebands and the carrier vary widely as the deviation is varied by increasing or decreasing the amount of modulation. Since the relationship between the amplitudes of the various sidebands and carrier to the audio modulating frequency and the deviation is known, a simple method of measuring the deviation of a frequency modulated transmitter is possible. In making the measurement, the result is given in the form of the modulation index for a certain amount of audio input. As previously described, the modulation index is the ratio of the peak frequency deviation to the frequency of the audio modulation.

The measurement is made by applying a sine-wave audio voltage of known frequency to the transmitter, and increasing the modulation until the amplitude of the carrier component of the frequency modulated wave reaches zero. The modulation index for zero carrier may then be determined from the table below. As may be seen from the table, the first point of zero carrier is obtained when the modulation index has a value of 2.405,—in other words, when the deviation is 2.405 times the modulation frequency. For example, if a modulation frequency of 1000 cycles is used, and the modulation is increased until the first carrier null is obtained, the deviation will then be 2.405 times the modulation frequency, or 2.405 kc. If the modulating frequency happened to be 2000 cycles, the deviation at the first null would be 4.810 kc. Other carrier nulls will be obtained when the index is 5.52, 8.654, and at increasing values separated approximately by π . The following is a listing of the modulation index at successive carrier nulls up to the tenth:

Zero carrier point no.	Modulation index
1	2.405
2	5.520
3	8.654
4	11.792
5	14.931
6	18.071
7	21.212
8	24.353
9	27.494
10	30.635

The only equipment required for making the measurements is a calibrated audio oscillator of good wave form, and a communication receiver equipped with a beat oscillator and crystal filter. The receiver should be used with its crystal filter set for minimum bandwidth to exclude sidebands spaced from the carrier by the modulation frequency. The un-

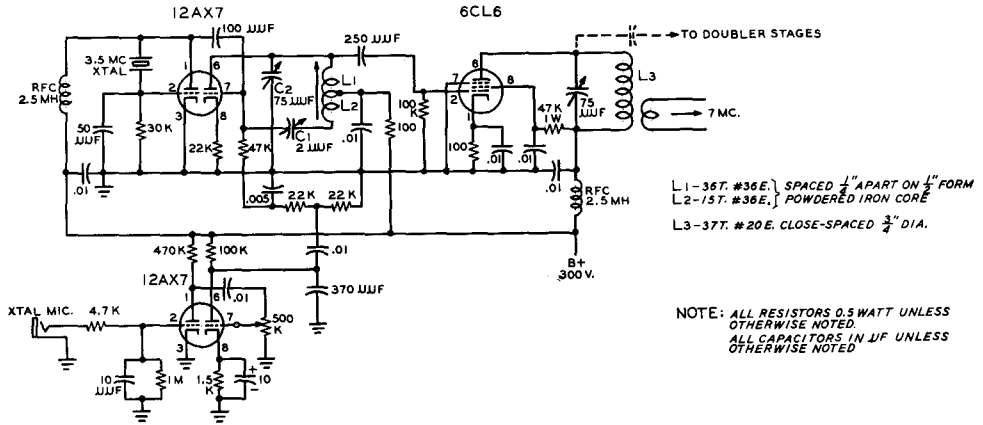

Figure 12
 REACTANCE MODULATOR FOR 10, 15 AND 20 METER OPERATION

modulated carrier is accurately tuned in on the receiver with the beat oscillator operating. Then modulation from the audio oscillator is applied to the transmitter, and the modulation is increased until the first carrier null is obtained. This carrier null will correspond to a modulation index of 2.405, as previously mentioned. Successive null points will correspond to the indices listed in the table.

A volume indicator in the transmitter audio system may be used to measure the audio level required for different amounts of deviation, and the indicator thus calibrated in terms of frequency deviation. If the measurements are made at the fundamental frequency of the oscillator, it will be necessary to multiply the frequency deviation by the harmonic upon which the transmitter is operating, of course. It will probably be most convenient to make the determination at some frequency intermediate between that of the oscillator and that at which the transmitter is operating, and then to multiply the result by the frequency multiplication between that frequency and the transmitter output frequency.

16-4 Reception of FM Signals

A conventional communications receiver may be used to receive narrow-band FM transmissions, although performance will be much poorer than can be obtained with an NBFM receiver or adapter. However, a receiver specifically designed for FM reception must be used when it is desired to receive high deviation FM such

as used by FM broadcast stations, TV sound, and mobile communications FM.

The FM receiver must have, first of all, a bandwidth sufficient to pass the range of frequencies generated by the FM transmitter. And since the receiver must be a superheterodyne if it is to have good sensitivity at the frequencies to which FM is restricted, i-f bandwidth is an important factor in its design.

The second requirement of the FM receiver is that it incorporate some sort of device for converting frequency changes into amplitude changes, in other words, a detector operating on frequency variations rather than amplitude variations. The third requirement, and one which is necessary if the full noise reducing capa-

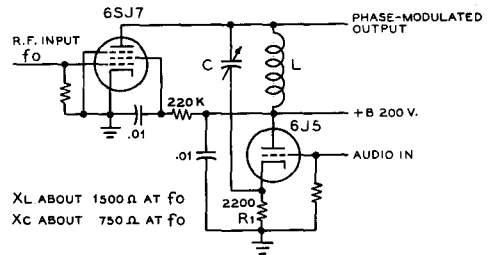

Figure 13
 CATHODE-FOLLOWER PHASE MODULATOR

The phase modulator illustrated above is quite satisfactory when the stage is to be operated on a single frequency or over a narrow range of frequencies.

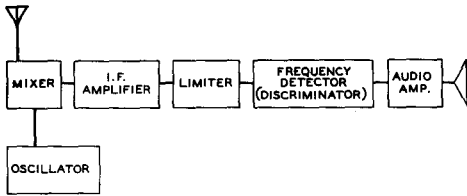

Figure 14

FM RECEIVER BLOCK DIAGRAM

Up to the amplitude limiter stage, the FM receiver is similar to an AM receiver, except for a somewhat wider i-f bandwidth. The limiter removes any amplitude modulation, and the frequency detector following the limiter converts frequency variations into amplitude variations.

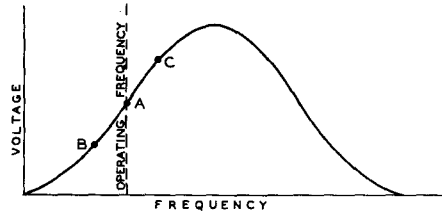

Figure 15

SLOPE DETECTION OF FM SIGNAL

One side of the response characteristic of a tuned circuit or of an i-f amplifier may be used as shown to convert frequency variations of an incoming signal into amplitude variations.

bilities of the FM system of transmission are desired, is a limiting device to eliminate amplitude variations before they reach the detector. A block diagram of the essential parts of an FM receiver is shown in figure 14.

The Frequency Detector The simplest device for converting frequency variations to amplitude variations is an "off-tune" resonant circuit, as illustrated in figure 15. With the carrier tuned in at point "A," a certain amount of r-f voltage will be developed across the tuned circuit, and, as the frequency is varied either side of this frequency by the modulation, the r-f voltage will increase and decrease to points "C" and "B" in accordance with the modulation. If the voltage across the tuned circuit is applied to an ordinary detector, the detector output will vary in accordance with the modulation, the amplitude of the variation being proportional to the deviation of the signal, and the rate being equal to the modulation frequency. It is obvious from figure 15 that only a small portion of the resonance curve is usable for linear conversion

of frequency variations into amplitude variations, since the linear portion of the curve is rather short. Any frequency variation which exceeds the linear portion will cause distortion of the recovered audio. It is also obvious by inspection of figure 15 that an AM receiver used in this manner is wide open to signals on the peak of the resonance curve and also to signals on the other side of the resonance curve. Further, no noise limiting action is afforded by this type of reception. This system, therefore, is not recommended for FM reception, although widely used by amateurs for occasional NBFM reception.

Travis Discriminator Another form of frequency detector or discriminator, is shown in figure 16. In this arrangement two tuned circuits are used, one tuned on each side of the i-f amplifier frequency, and with their resonant frequencies spaced slightly more than the expected transmitter swing. Their outputs are combined in a differential rectifier so that the voltage across the series load resistors, R_1 and R_2 , is equal to the algebraic sum of the individual output voltages of each rectifier. When a signal at the

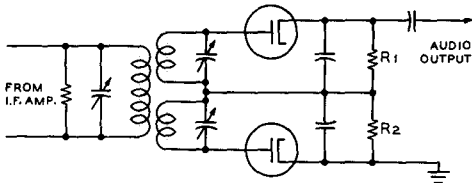

Figure 16

TRAVIS DISCRIMINATOR

This type of discriminator makes use of two off-tuned resonant circuits coupled to a single primary winding. The circuit is capable of excellent linearity, but is difficult to align.

At its "center" frequency the discriminator produces zero output voltage. On either side of this frequency it gives a voltage of a polarity and magnitude which depend on the direction and amount of frequency shift.

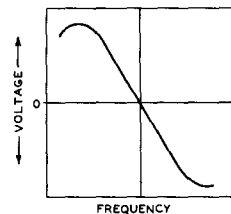

Figure 17

DISCRIMINATOR VOLTAGE-FREQUENCY CURVE

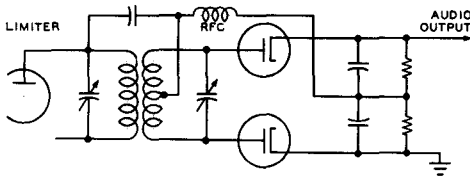

Figure 18
FOSTER-SEELEY DISCRIMINATOR

This discriminator is the most widely used circuit since it is capable of excellent linearity and is relatively simple to align when proper test equipment is available.

i-f mid-frequency is received, the voltages across the load resistors are equal and opposite, and the sum voltage is zero. As the r-f signal varies from the mid-frequency, however, these individual voltages become unequal, and a voltage having the polarity of the larger voltage and equal to the difference between the two voltages appears across the series resistors, and is applied to the audio amplifier. The relationship between frequency and discriminator output voltage is shown in figure 17. The separation of the discriminator peaks and the linearity of the output voltage vs. frequency curve depend upon the discriminator frequency, the Q of the tuned circuits, and the value of the diode load resistors. As the intermediate (and discriminator) frequency is increased, the peaks must be separated further to secure good linearity and output. Within limits, as the diode load resistance or the Q is reduced, the linearity improves, and the separation between the peaks must be greater.

Foster-Seeley Discriminator The most widely used form of discriminator is that shown in figure 18. This type of discriminator yields an output-voltage-versus-frequency characteristic similar to that shown in figure 19. Here, again, the output voltage is equal to the algebraic sum of the voltages developed across the load resistors of the two diodes, the resistors being connected in series to ground. However, this *Foster-Seeley* discriminator requires only two tuned circuits instead of the three used in the previous discriminator. The operation of the circuit results from the phase relationships existing in a transformer having a tuned secondary. In effect, as a close examination of the circuit will reveal, the primary circuit is in series, for r.f., with each half of the secondary to ground. When the received signal is at the resonant frequency of the secondary, the r-f voltage across the secondary is 90 degrees out of phase with that across the primary. Since each diode is connected across one half of the secondary wind-

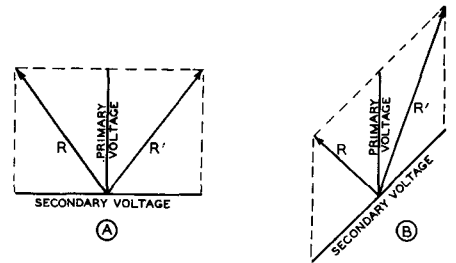

Figure 19
DISCRIMINATOR VECTOR DIAGRAM

A signal at the resonant frequency of the secondary will cause the secondary voltage to be 90 degrees out of phase with the primary voltage, as shown at A, and the resultant voltages R and R' are equal. If the signal frequency changes, the phase relationship also changes, and the resultant voltages are no longer equal, as shown at B. A differential rectifier is used to give an output voltage proportional to the difference between R and R'.

ing and the primary winding in series, the resultant r-f voltages applied to each are equal, and the voltages developed across each diode load resistor are equal and of opposite polarity. Hence, the net voltage between the top of the load resistors and ground is zero. This is shown vectorially in figure 19A where the resultant voltages R and R' which are applied to the two diodes are shown to be equal when the phase angle between primary and secondary voltages is 90 degrees. If, however, the signal varies from the resonant frequency, the 90-degree phase relationship no longer exists between primary and secondary. The result of this effect is shown in figure 19B where the secondary r-f voltage is no longer 90 degrees out of phase with respect to the primary voltage. The resultant voltages applied to the two diodes are now no longer equal, and a d-c voltage proportional to the difference between the r-f voltages applied to the two diodes will exist across the series load resistors. As the signal frequency varies back and forth across the resonant frequency of the discriminator, an a-c voltage of the same frequency as the original modulation, and proportional to the deviation, is developed and passed on to the audio amplifier.

Ratio Detector One of the more recent types of FM detector circuits, called the *ratio detector* is diagrammed in figure 20. The input transformer can be designed so that the parallel input voltage to the diodes can be taken from a tap on the primary of the trans-

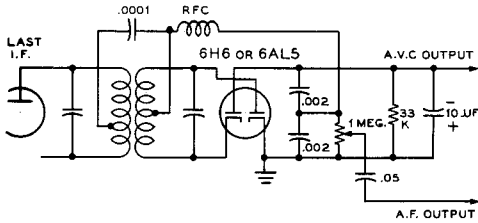

Figure 20

RATIO DETECTOR CIRCUIT

The parallel voltage to the diodes in a ratio detector may be obtained from a tap on the primary winding of the transformer or from a third winding. Note that one of the diodes is reversed from the system used with the Foster-Seeley discriminator, and that the output circuit is completely different. The ratio detector does not have to be preceded by a limiter, but is more difficult to align for distortion-free output than the conventional discriminator.

former, or this voltage may be obtained from a tertiary winding coupled to the primary. The r-f choke used must have high impedance at the intermediate frequency used in the receiver, although this choke is not needed if the transformer has a tertiary winding.

The circuit of the ratio detector appears very similar to that of the more conventional discriminator arrangement. However, it will be noted that the two diodes in the ratio detector are poled so that their d-c output voltages add, as contrasted to the Foster-Seeley circuit wherein the diodes are poled so that the d-c output voltages buck each other. At the center frequency to which the discriminator transformer is tuned the voltage appearing at the top of the 1-megohm potentiometer will be one-half the d-c voltage appearing at the *a-v-c output* terminal—since the contribution of each diode will be the same. However, as the input frequency varies to one side or the other of the tuned value (while remaining within the pass band of the i-f amplifier feeding the detector) the relative contributions of the two diodes will be different. The voltage appearing at the top of the 1-megohm volume control will increase for frequency deviations in one direction and will decrease for frequency deviations in the other direction from the mean or tuned value of the transformer. The audio output voltage is equal to the ratio of the relative contributions of the two diodes, hence the name ratio detector.

The ratio detector offers several advantages over the simple discriminator circuit. The circuit does not require the use of a limiter preceding the detector since the circuit is inherently insensitive to amplitude modulation on

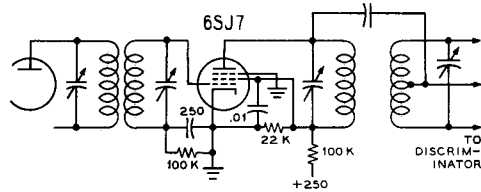

Figure 21

LIMITER CIRCUIT

One, or sometimes two, limiter stages normally precede the discriminator so that a constant signal level will be fed to the FM detector. This procedure eliminates amplitude variations in the signal fed to the discriminator, so that it will respond only to frequency changes.

an incoming signal. This factor alone means that the r-f and i-f gain ahead of the detector can be much less than the conventional discriminator for the same overall sensitivity. Further, the circuit provides a-v-c voltage for controlling the gain of the preceding r-f and i-f stages. The ratio detector is, however, susceptible to variations in the amplitude of the incoming signal as is any other detector circuit except the discriminator *with* a limiter preceding it, so that a-v-c should be used on the stages preceding the detector.

Limiters The limiter of an FM receiver using a conventional discriminator serves to remove amplitude modulation and pass on to the discriminator a frequency modulated signal of constant amplitude; a typical circuit is shown in figure 21. The limiter tube is operated as an i-f stage with very low plate voltage and with grid leak bias, so that it overloads quite easily. Up to a certain point the output of the limiter will increase with an increase in signal. Above this point, however, the limiter becomes overloaded, and further large increases in signal will not give any increase in output. To operate successfully, the limiter must be supplied with a large amount of signal, so that the amplitude of its output will not change for rather wide variations in amplitude of the signal. Noise, which causes little frequency modulation but much amplitude modulation of the received signal, is virtually wiped out in the limiter.

The voltage across the grid resistor varies with the amplitude of the received signal. For this reason, conventional amplitude modulated signals may be received on the FM receiver by connecting the input of the audio amplifier to the top of this resistor, rather than to the discriminator output. When properly filtered

by a simple R-C circuit, the voltage across the grid resistor may also be used as a-v-c voltage for the receiver. When the limiter is operating properly, a.v.c. is neither necessary nor desirable, however, for FM reception alone.

Receiver Design Considerations

One of the most important factors in the design of an FM receiver is the frequency swing which it is intended to handle. It will be apparent from figure 17 that if the straight portion of the discriminator circuit covers a wider range of frequencies than those generated by the transmitter, the audio output will be reduced from the maximum value of which the receiver is capable.

In this respect, the term "modulation percentage" is more applicable to the FM receiver than it is to the transmitter, since the modulation capability of the communication system is limited by the receiver bandwidth and the discriminator characteristic; full utilization of the linear portion of the characteristic amounts, in effect, to 100 per cent modulation. This means that some sort of standard must be agreed upon, for any particular type of communication, to make it unnecessary to vary the transmitter swing to accommodate different receivers.

Two considerations influence the receiver bandwidth necessary for any particular type of communication. These are the maximum audio frequency which the system will handle, and the deviation ratio which will be employed. For voice communication, the maximum audio frequency is more or less fixed at 3000 to 4000 cycles. In the matter of deviation ratio, however, the amount of noise suppression which the FM system will provide is influenced by the ratio chosen, since the improvement in signal-to-noise ratio which the FM system shows over amplitude modulation is equivalent to a constant multiplied by the deviation ratio. This assumes that the signal is somewhat stronger than the noise at the receiver, however, as the advantages of wideband FM in regard to noise suppression disappear when the signal-to-noise ratio approaches unity.

On the other hand, a low deviation ratio is more satisfactory for strictly communication work, where readability at low signal-to-noise ratios is more important than additional noise suppression when the signal is already appreciably stronger than the noise.

As mentioned previously, broadcast FM practice is to use a deviation ratio of 5. When this ratio is applied to a voice-communication system, the total swing becomes 30 to 40 kc. With lower deviation ratios, such as are most frequently used for voice work, the swing becomes proportionally less, until at a deviation ratio of 1 the swing is equal to twice the highest audio frequency. Actually, however, the re-

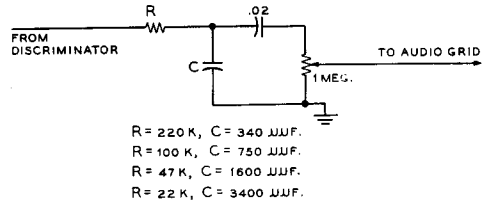

Figure 22
75-MICROSECOND DE-EMPHASIS
CIRCUITS

The audio signal transmitted by FM and TV stations has received high-frequency pre-emphasis, so that a de-emphasis circuit should be included between the output of the FM detector and the input of the audio system.

ceiver bandwidth must be slightly greater than the expected transmitter swing, since for distortionless reception the receiver must pass the complete band of energy generated by the transmitter, and this band will always cover a range somewhat wider than the transmitter swing.

Pre-Emphasis and De-Emphasis Standards in FM broadcast and TV sound work call for the pre-emphasis of all audio modulating frequencies above about 2000 cycles, with a rising slope such as would be produced by a 75-microsecond RL network. Thus the FM receiver should include a compensating de-emphasis RC network with a time constant of 75 microseconds so that the overall frequency response from microphone to loudspeaker will approach linearity. The use of pre-emphasis and de-emphasis in this manner results in a considerable improvement in the overall signal-to-noise ratio of an FM system. Appropriate values for the de-emphasis network, for different values of circuit impedance are given in figure 22.

A NBFM 455-kc. Adapter Unit The unit diagrammed in figure 23 is designed to provide NBFM reception when attached to any communication receiver having a 455-kc. i-f amplifier. Although NBFM can be received on an AM receiver by tuning the receiver to one side or the other of the incoming signal, a tremendous improvement in signal-to-noise ratio and in signal to amplitude ratio will be obtained by the use of a true FM detector system.

The adapter uses two tubes. A 6AU6 is used as a limiter, and a 6AL5 as a discriminator. The audio level is approximately 10

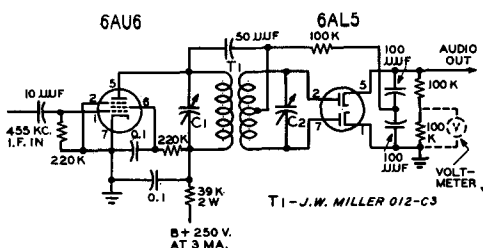

NOTE: ALL CAPACITORS IN μJF UNLESS OTHERWISE NOTED
ALL RESISTORS 0.5 WATT UNLESS OTHERWISE NOTED

Figure 23
NBFM ADAPTER FOR 455-KC. I-F SYSTEM

volts peak for the maximum deviation which can be handled by a conventional 455-kc. i-f system. The unit may be tuned by placing a high resistance d-c voltmeter across R_1 and tuning the trimmers of the i-f transformer for maximum voltage when an unmodulated signal is injected into the i-f strip of the receiver. The voltmeter should next be connected across the audio output terminal of the discriminator. The receiver is now tuned back and forth across the frequency of the incoming signal, and the movement of the voltmeter noted. When the receiver is exactly tuned on the signal the voltmeter reading should be zero. When the receiver is tuned to one side of center, the voltmeter reading should increase to a maximum value and then decrease gradually to zero as the signal is tuned out of the passband of the receiver. When the receiver is tuned to the other side of the signal the voltmeter should increase to the same maximum value but in the opposite direction or polarity, and then fall to zero as the signal is tuned out of the passband. It may be necessary to make small adjustments to C_1 and C_2 to make the voltmeter read zero when the signal is tuned in the center of the passband.

16-5 Radio Teletype

The *teletype* machine is an electric typewriter that is stimulated by d.c. pulses originated by the action of a second machine. The pulses may be transmitted from one machine to another by wire, or by a radio signal. When radio transmission is used, the system is termed *radio teletype* (RTTY).

The d.c. pulses that comprise the teletype signal may be converted into three basic types of emission suitable for radio transmission. These are: 1- *Frequency shift keying* (FSK), designated as F1 emission; 2- *Make-break*

keying (MBK), designated as A1 emission; and 3- *Audio frequency shift keying* (AFSK), designated as F2 emission.

Frequency shift keying is obtained by varying the transmitted frequency of the radio signal a fixed amount (usually 850 cycles) during the keying process. The shift is accomplished in discrete intervals designated *mark* and *space*. Both types of intervals convey information to the teletype printer. Make-break keying is analogous to simple c-w transmission in that the radio carrier conveys information by changing from an *off* to an *on* condition. Early RTTY circuits employed MBK equipment, which is rapidly becoming obsolete since it is inferior to the frequency shift system.

Audio frequency shift keying employs a steady radio carrier modulated by an audio tone that is shifted in frequency according to the RTTY pulses. Other forms of information transmission may be employed by a RTTY system which also encompass the translation of RTTY pulses into r-f signals.

Teletype Coding The RTTY code consists of the 26 letters of the alphabet, the space, the line feed, the carriage return, the bell, the upper case shift, and the lower case shift; making a total of 32 coded groups. Numerals, punctuation, and symbols may be taken care of in the case shift, since all transmitted letters are capitals.

The FSK system normally employs the higher radio frequency as the mark, and the lower frequency as the space. This relationship holds true in the AFSK system also. The lower audio frequency (mark) is normally 2125 cycles and the higher audio tone (space) is 2975 cycles, giving a frequency difference of 850 cycles.

The Teletype System A simple FSK teletype system may be added to any c-w transmitter. The teletype keyboard prints the keyed letters on a tape, and at the same time generates the electrical code group that describes the letter. The d.c. pulses are impressed upon a distributor unit which arranges the typing and spacing pulses in proper sequence. The resulting series of impulses are applied to the transmitter frequency control device, which may be a reactance modulator, actuated by a polar relay.

The received signal is heterodyned against a beat oscillator to provide the two audio tones which are limited in amplitude and passed through audio filters to separate them. Rectification of the tones permits operation of a polar relay which can provide d.c. pulses suitable for operation of the tele-typewriter.

Sideband Transmission

While *single-sideband transmission* (SSB) has attracted significant interest on amateur frequencies only in the past few years, the principles have been recognized and put to use in various commercial applications for many years. Expansion of single-sideband for both commercial and amateur communication has awaited the development of economical components possessing the required characteristics (such as sharp cutoff filters and high stability crystals) demanded by SSB techniques. The availability of such components and precision test equipment now makes possible the economical testing, adjustment and use of SSB equipment on a wider scale than before. Many of the seemingly insurmountable obstacles of past years no longer prevent the amateur from achieving the advantages of SSB for his class of operation.

17-1 Commercial Applications of SSB

Before discussion of amateur SSB equipment, it is helpful to review some of the commercial applications of SSB in an effort to avoid problems that are already solved.

The first and only large scale use of SSB has been for multiplexing additional voice circuits on long distance telephone toll wires. Carrier systems came into wide use during the 30's, accompanied by the development of high Q toroids and copper oxide ring modulators of controlled characteristics.

The problem solved by the carrier system was that of translating the 300-3000 cycle voice band of frequencies to a higher frequency (for example, 40.3 to 43.0 kc.) for transmission on the toll wires, and then to reverse the translation process at the receiving terminal. It was possible in some short-haul equipment to amplitude modulate a 40 kilocycle carrier with the voice frequencies, in which case the resulting signal would occupy a band of frequencies between 37 and 43 kilocycles. Since the transmission properties of wires and cable deteriorate rapidly with increasing frequency, most systems required the bandwidth conservation characteristics of single-sideband transmission. In addition, the carrier wave was generally suppressed to reduce the power handling capability of the repeater amplifiers and diode modulators. A substantial body of literature on the components and circuit techniques of SSB has been generated by the large and continuing development effort to produce economical carrier telephony systems.

The use of SSB for overseas radiotelephony has been practiced for several years though the number of such circuits has been numerically small. However, the economic value of such circuits has been great enough to warrant elaborate station equipment. It is from these stations that the impression has been obtained that SSB is too complicated for all but a corps of engineers and technicians to handle. Components such as lattice filters with 40 or more crystals have suggested astronomical expense.

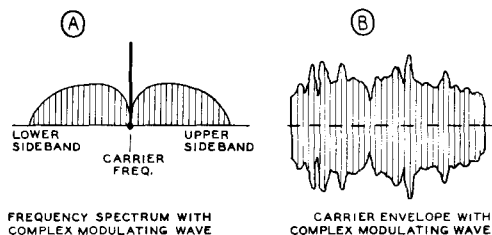

Figure 1
REPRESENTATION OF A
CONVENTIONAL AM SIGNAL

More recently, SSB techniques have been used to multiplex large numbers of voice channels on a microwave radio band using equipment principally developed for telephone carrier applications. It should be noted that all production equipment employed in these services uses the *filter method* of generating the single-sideband signal, though there is a wide variation in the types of filters actually used. The SSB signal is generated at a low frequency and at a low level, and then translated and linearly amplified to a high level at the operating frequency.

Considerable development effort has been expended on high level phasing type transmitters wherein the problems of linear amplification are exchanged for the problems of accurately controlled phase shifts. Such equipment has featured automatic tuning circuits, servo-driven to facilitate frequency changing, but no transmitter of this type has been sufficiently attractive to warrant appreciable production.

17-2 Derivation of Single-Sideband Signals

The single-sideband method of communication is, essentially, a procedure for obtaining more efficient use of available frequency spectrum and of available transmitter capability. As a starting point for the discussion of single-sideband signals, let us take a conventional AM signal, such as shown in figure 1, as representing the most common method for transmitting complex intelligence such as voice or music.

It will be noted in figure 1 that there are three distinct portions to the signal: the carrier, and the upper and the lower sideband group. These three portions always are present in a conventional AM signal. Of all these portions the carrier is the least necessary and the most expensive to transmit. It is an actual

fact, and it can be proved mathematically (and physically with a highly selective receiver) that the carrier of an AM signal remains unchanged in amplitude, whether it is being modulated or not. Of course the carrier *appears* to be modulated when we observe the modulated signal on a receiving system or indicator which passes a sufficiently wide band that the carrier and the modulation sidebands are viewed at the same time. This apparent change in the amplitude of the carrier with modulation is simply the result of the sidebands beating with the carrier. However, if we receive the signal on a highly selective receiver, and if we modulate the carrier with a sine wave of 3000 to 5000 cycles, we will readily see that the carrier, or either of the sidebands can be tuned in separately; the carrier amplitude, as observed on a signal strength meter, will remain constant, while the amplitude of the sidebands will vary in direct proportion to the modulation percentage.

Elimination of the Carrier and One Sideband

It is obvious from the previous discussion that the carrier is superfluous so far as the transmission of intelligence is concerned. It is obviously a convenience, however, since it provides a signal at the receiving end for the sidebands to beat with and thus to reproduce the original modulating signal. It is equally true that the transmission of both sidebands under ordinary conditions is superfluous since identically the same intelligence is contained in both sidebands. Several systems for carrier and sideband elimination will be discussed in this chapter.

Power Advantage of SSB over AM

Single sideband is a very efficient form of voice communication by radio. The amount of radio frequency spectrum occupied can be no greater than the frequency range of the audio or speech signal transmitted, whereas other forms of radio transmission require from two to several times as much spectrum space. The r-f power in the transmitted SSB signal is directly proportional to the power in the original audio signal and no strong carrier is transmitted. Except for a weak pilot carrier present in some commercial usage, there is no r-f output when there is no audio input.

The power output rating of a SSB transmitter is given in terms of *peak envelope power* (PEP). This may be defined as the r-m-s power at the crest of the modulation

envelope. The peak envelope power of a conventional amplitude modulated signal at 100% modulation is four times the carrier power. The average power input to a SSB transmitter is therefore a very small fraction of the power input to a conventional amplitude modulated transmitter of the same power rating.

Single sideband is well suited for long-range communications because of its spectrum and power economy and because it is less susceptible to the effects of selective fading and interference than amplitude modulation. The principal advantages of SSB arise from the elimination of the high-energy carrier and from further reduction in sideband power permitted by the improved performance of SSB under unfavorable propagation conditions.

In the presence of narrow band man-made interference, the narrower bandwidth of SSB reduces the probability of destructive interference. A statistical study of the distribution of signals on the air versus the signal strength shows that the probability of successful communication will be the same if the SSB power is equal to one-half the power of one of the two a-m sidebands. Thus SSB can give from 0 to 9 db improvement under various conditions when the total sideband power is equal in SSB and a-m. In general, it may be assumed that 3 db of the possible 9 db advantage will be realized on the average contact. In this case, the SSB power required for equivalent performance is equal to the power in one of the a-m sidebands. For example, this would rate a 100-watt SSB and a 400 watt (carrier) a-m transmitter as having equal performance. It should be noted that in this comparison it is assumed that the receiver bandwidth is just sufficient to accept the transmitted intelligence in each case.

To help evaluate other methods of comparison the following points should be considered. In conventional amplitude modulation two sidebands are transmitted, each having a peak envelope power equal to $\frac{1}{4}$ -carrier power. For example, a 100-watt a-m signal will have 25-watt peak envelope power in each sideband, or a total of 50 watts. When the receiver detects this signal, the voltages of the two sidebands are added in the detector. Thus the detector output voltage is equivalent to that of a 100-watt SSB signal. This method of comparison says that a 100 watt SSB transmitter is just equivalent to a 100-watt a-m transmitter. This assumption is valid only when the receiver bandwidth used for SSB is the same as that required for amplitude modulation

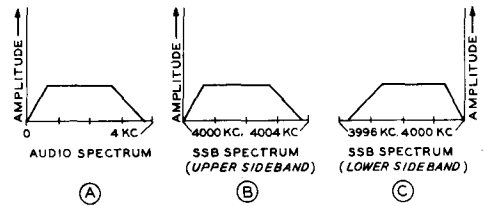

Figure 2
RELATIONSHIP OF AUDIO AND SSB SPECTRUMS

The single sideband components are the same as the original audio components except that the frequency of each is raised by the frequency of the carrier. The relative amplitude of the various components remains the same.

(e.g., 6 kilocycles), when there is no noise or interference other than broadband noise, and if the a-m signal is not degraded by propagation. By using half the bandwidth for SSB reception (e.g., 3 kilocycles) the noise is reduced 3 db so the 100 watt SSB signal becomes equivalent to a 200 watt carrier a-m signal. It is also possible for the a-m signal to be degraded another 3 db on the average due to narrow band interference and poor propagation conditions, giving a possible 4 to 1 power advantage to the SSB signal.

It should be noted that 3 db signal-to-noise ratio is lost when receiving only one sideband of an a-m signal. The narrower receiving bandwidth reduces the noise by 3 db but the 6 db advantage of coherent detection is lost, leaving a net loss of 3 db. Poor propagation will degrade this "one sideband" reception of an a-m signal less than double sideband reception, however. Also under severe narrow band interference conditions (e.g., an adjacent strong signal) the ability to reject all interference on one side of the carrier is a great advantage.

The Nature of a SSB Signal

The nature of a single sideband signal is easily visualized by noting that the SSB signal components are exactly the same as the original audio components except that the frequency of each is raised by the frequency of the carrier. The relative amplitude of the various components remains the same, however. (The first statement is only true for the upper sideband since the lower sideband frequency components are the difference between the carrier and the original audio signal). Figure 2A, B, and C shows how the audio spectrum is simply moved up into the radio spectrum to give the upper sideband. The lower sideband is the same except inverted, as shown in figure 2C. Either sideband may be used. It is apparent that the carrier frequency

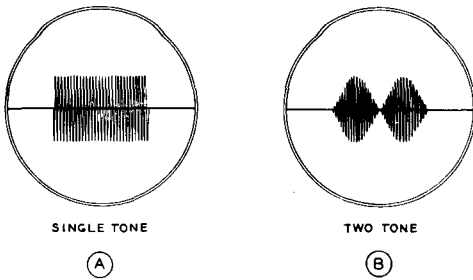

Figure 3
A SINGLE SINE WAVE TONE INPUT TO A SSB TRANSMITTER RESULTS IN A STEADY SINGLE SINE WAVE R-F OUTPUT (A). TWO AUDIO TONES OF EQUAL AMPLITUDE BEAT TOGETHER TO PRODUCE HALF-SINE WAVES AS SHOWN IN (B).

of a SSB signal can only be changed by adding or subtracting to the original carrier frequency. This is done by heterodyning, using converter or mixer circuits similar to those employed in a superheterodyne receiver.

It is noted that a single sine wave tone input to a SSB transmitter results in a single steady sine wave r-f output, as shown in figure 3A. Since it is difficult to measure the performance of a linear amplifier with a single tone, it has become standard practice to use two tones of equal amplitude for test purposes. The two radio frequencies thus produced beat together to give the SSB envelope shown in figure 3B. This figure has the shape of half sine waves, and from one null to the next represents one full cycle of the difference frequency. How this envelope is generated is shown more fully in figures 4A and 4B. f_1 and f_2 represent the two tone signals. When a vector representing the lower frequency tone signal is used as a reference, the other vector rotates around it as shown, and this action

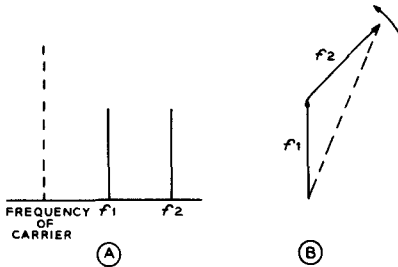

Figure 4
VECTOR REPRESENTATION OF TWO-TONE SSB ENVELOPE

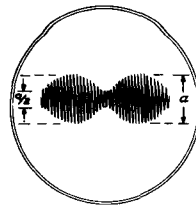

Figure 5
TWO-TONE SSB ENVELOPE WHEN ONE TONE HAS TWICE THE AMPLITUDE OF THE OTHER.

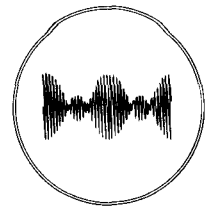

Figure 6
THREE-TONE SSB ENVELOPE WHEN EQUAL TONES OF EQUAL FREQUENCY SPACINGS ARE USED.

generates the SSB envelope. When the two vectors are exactly opposite in phase, the output is zero and this causes the null in the envelope. If one tone has twice the amplitude of the other, the envelope shape is shown in figure 5. Figure 6 shows the SSB envelope of three equal tones of equal frequency spacings and at one particular phase relationship. Figure 7A shows the SSB envelope of four equal tones with equal frequency spacings and at one particular phase relationship. The phase relationships chosen are such that at some instant the vectors representing the several tones are all in phase. Figure 7B shows a SSB envelope of a square wave. A pure square wave requires infinite bandwidth, so its SSB envelope requires infinite amplitude. This emphasizes the point that the SSB envelope shape is not the same as the original audio wave shape, and usually bears no similarity to it. This is because the percentage difference between the radio frequencies is very small, even though one audio tone may be several times the other in terms of frequency. Speech clipping as used

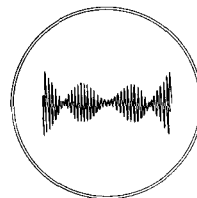

Figure 7A
FOUR TONE SSB ENVELOPE when equal tones with equal frequency spacings are used

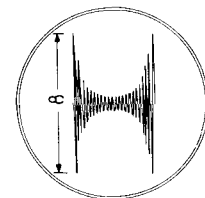

Figure 7B
SSB ENVELOPE OF A SQUARE WAVE. Peak of wave reaches infinite amplitude.

in amplitude modulation is of no practical value in SSB because the SSB r-f envelopes are so different than the audio envelopes. A heavily clipped wave approaches a square wave and a square wave gives a SSB envelope with peaks of infinite amplitude as shown in figure 7B.

Carrier Frequency Stability Requirements Reception of a SSB signal is accomplished by simply heterodyning the carrier down to zero frequency. (The conversion frequency used in the last heterodyne step is often called the *reinserted carrier*). If the SSB signal is not heterodyned down to exactly zero frequency, each frequency component of the detected audio signal will be high or low by the amount of this error. An error of 10 to 20 c.p.s. for speech signals is acceptable from an intelligibility standpoint, but an error of the order of 50 c.p.s. seriously degrades the intelligibility. An error of 20 c.p.s. is not acceptable for the transmission of music, however, because the harmonic relationship of the notes would be destroyed. For example, the harmonics of 220 c.p.s. are 440, 660, 880, etc., but a 10 c.p.s. error gives 230, 450, 670, 890, etc., or 210, 430, 650, 870, etc., if the original error is on the other side. This error would destroy the original sound of the tones, and the harmony between the tones.

Suppression of the carrier is common in amateur SSB work, so the combined frequency stabilities of all oscillators in both the transmitting and receiving equipment add together to give the frequency error found in detection. In order to overcome much of the frequency stability problem, it is common commercial practice to transmit a pilot carrier at a reduced amplitude. This is usually 20 db below one tone of a two-tone signal, or 26 db below the peak envelope power rating of the transmitter. This pilot carrier is filtered out from the other signals at the receiver and either amplified and used for the reinserted carrier or used to control the frequency of a local oscillator. By this means, the frequency drift of the carrier is eliminated as an error in detection.

Advantage of SSB with Selective Fading On long distance communication circuits using a-m, selective fading often causes severe distortion and at times makes the signal unintelligible. When one sideband is weaker than the other, distor-

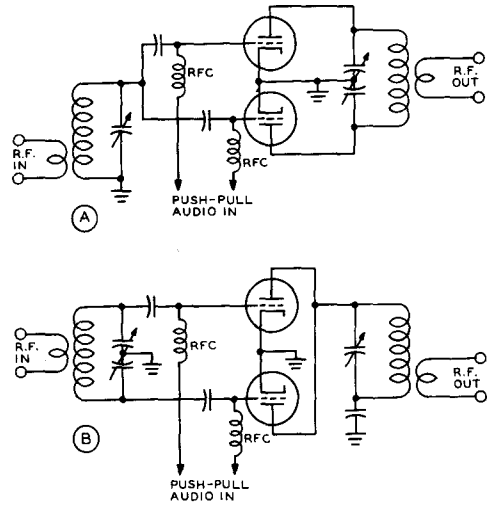

Figure 8
SHOWING TWO COMMON TYPES
OF BALANCED MODULATORS

Notice that a balanced modulator changes the circuit condition from single ended to push-pull, or vice versa. Choice of circuit depends upon external circuit conditions since both the (A) and (B) arrangements can give satisfactory generation of a double-sideband suppressed-carrier signal.

tion results; but when the carrier becomes weak and the sidebands are strong, the distortion is extremely severe and the signal may sound like "monkey chatter." This is because a carrier of at least twice the amplitude of either sideband is necessary to demodulate the signal properly. This can be overcome by using exalted carrier reception in which the carrier is amplified separately and then reinserted before the signal is demodulated or detected. This is a great help, but the reinserted carrier must be very close to the same phase as the original carrier. For example, if the reinserted carrier were 90 degrees from the original source, the a-m signal would be converted to phase modulation and the usual a-m detector would deliver no output.

The phase of the reinserted carrier is of no importance in SSB reception and by using a strong reinserted carrier, exalted carrier reception is in effect realized. Selective fading with one sideband simply changes the amplitude and the frequency response of the system and very seldom causes the signal to become unintelligible. Thus the receiving techniques used with SSB are those which inherently greatly minimize distortion due to selective fading.

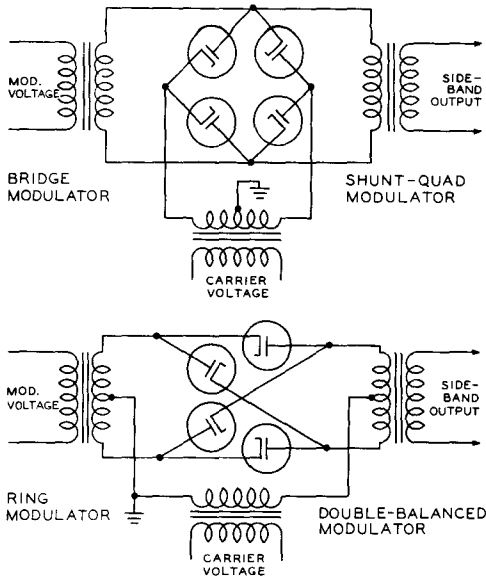

Figure 9
TWO TYPES OF DIODE BALANCED MODULATOR

Such balanced modulator circuits are commonly used in carrier telephone work and in single-sideband systems where the carrier frequency and modulating frequency are relatively close together. Vacuum diodes, copper-oxide rectifiers, or crystal diodes may be used in the circuits.

17-3 Carrier Elimination Circuits

Various circuits may be employed to eliminate the carrier to provide a double sideband signal. A selective filter may follow the carrier elimination circuit to produce a single sideband signal.

Two modulated amplifiers may be connected with the carrier inputs 180° out of phase, and with the carrier outputs in parallel. The car-

rier will be balanced out of the output circuit, leaving only the two sidebands. Such a circuit is called a *balanced modulator*.

Any non-linear element will produce modulation. That is, if two signals are put in, sum and difference frequencies as well as the original frequencies appear in the output. This phenomenon is objectionable in amplifiers and desirable in modulators or mixers.

In addition to the sum and difference frequencies, other outputs (such as twice one frequency plus the other) may appear. All combinations of all harmonics of each input frequency may appear, but in general these are of decreasing amplitude with increasing order of harmonic. These outputs are usually rejected by selective circuits following the modulator. All modulators are not alike in the magnitude of these higher order outputs. Balanced diode rings operating in the square law region are fairly good and pentagrid converters much poorer. Excessive carrier level in tube mixers will increase the relative magnitude of the higher order outputs. Two types of triode balanced modulators are shown in figure 8, and two types of diode modulators in figure 9. Balanced modulators employing vacuum tubes may be made to work very easily to a point. Circuits may be devised wherein both input signals may be applied to a high impedance grid, simplifying isolation and loading problems. The most important difficulties with these vacuum tube modulator circuits are: (1) Balance is not independent of signal level. (2) Balance drifts with time and environment. (3) The carrier level for low "high-order output" is critical, and (4) Such circuits have limited dynamic range.

A number of typical circuits are shown in figure 10. Of the group the most satisfactory performance is to be had from plate modulated triodes.

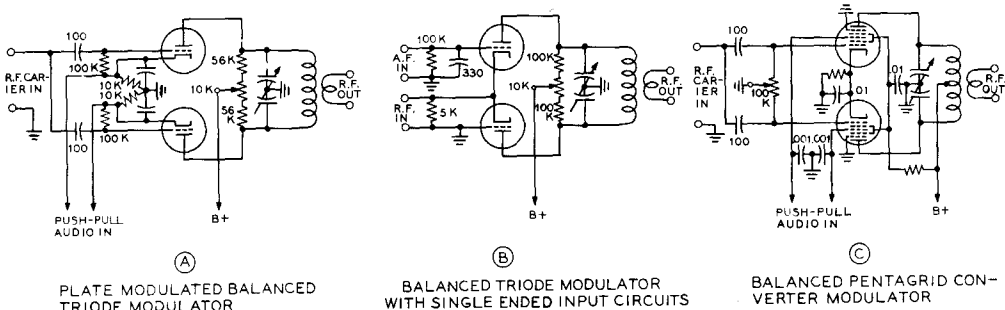

Figure 10
BALANCED MODULATORS

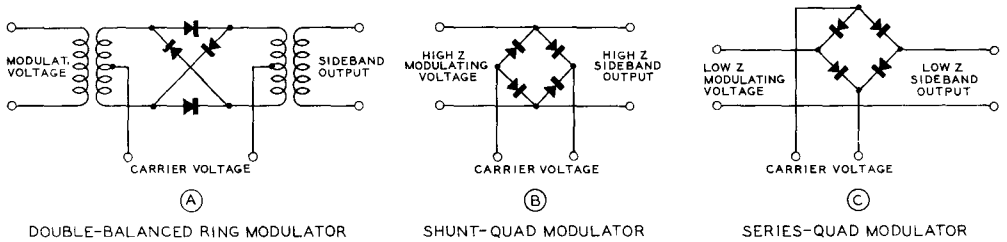

Figure 11
DIODE RING MODULATORS

Diode Ring Modulators

Modulation in telephone carrier equipment has been very successfully accomplished with copper-oxide double balanced ring modulators. More recently, germanium diodes have been applied to similar circuits. The basic diode ring circuits are shown in figure 11. The most widely applied is the double balanced ring (A). Both carrier and input are balanced with respect to the output, which is advantageous when the output frequency is not sufficiently different from the inputs to allow ready separation by filters. It should be noted that the carrier must pass through the balanced input and output transformers. Care must be taken in adapting this circuit to minimize the carrier power that will be lost in these elements. The shunt and series quad circuits are usable when the output frequencies are entirely different (i.e.: audio and r.f.). The shunt quad (B) is used with high source and load impedances and the series quad (C) with low source and load impedances. These two circuits may be adapted to use only two diodes, substituting a balanced transformer for one side of the bridge, as shown in figure 12. It should be noted that these circuits present a half-wave load to the carrier source. In applying any of these circuits, r-f chokes and capacitors must be employed to control the path of signal and carrier currents. In the shunt pair, for example, a blocking capacitor is used to prevent the r-f load from shorting the audio input.

To a first approximation, the source and load impedances should be an arithmetical mean of the forward and back resistances of the diodes employed. A workable rule of thumb is that the source and load impedances be ten to twenty times the forward resistance for semi-conductor rings. The high frequency limit of operation in the case of junction and copper-oxide diodes may be appreciably extended by the use of very low source and load impedances.

Copper-oxide diodes suitable for carrier

work are normally manufactured to order. They offer no particular advantage to the amateur, though their excellent long-term stability is important in commercial applications. Rectifier types intended to be used as meter rectifiers are not likely to have the balance or high frequency response desirable in amateur SSB transmitters.

Vacuum diodes such as the 6AL5 may be used as modulators. Balancing the heater-cathode capacity is a major difficulty except when the 6AL5 is used at low source and load impedance levels. In addition, contact potentials of the order of a few tenths of a volt may also disturb low level applications (figure 13).

The double diode circuits appear attractive, but in general it is more difficult to balance a transformer at carrier frequency than an additional pair of diodes. Balancing potentiometers may be employed, but the actual cause of the unbalance is far more subtle, and cannot be adequately corrected with a single adjustment.

A signal produced by any of the above circuits may be classified as a *double sideband, suppressed-carrier* signal.

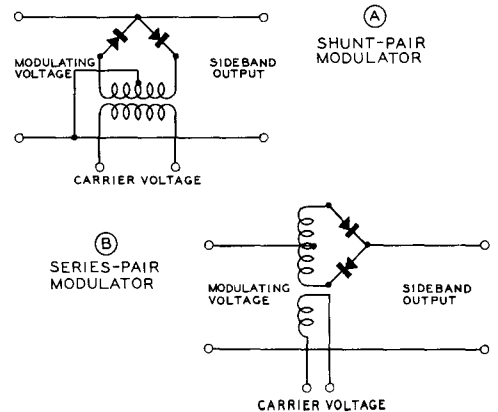
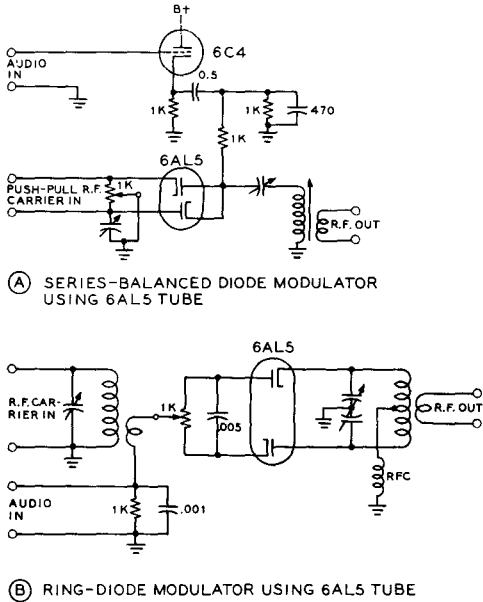

Figure 12
DOUBLE-DIODE PAIRED MODULATORS



(A) SERIES-BALANCED DIODE MODULATOR USING 6AL5 TUBE

(B) RING-DIODE MODULATOR USING 6AL5 TUBE

Figure 13
VACUUM DIODE MODULATOR CIRCUITS

17-4 Generation of Single-Sideband Signals

In general, there are two commonly used methods by which a single-sideband signal may be generated. These systems are: (1) The Filter Method, and (2) The Phasing Method. The systems may be used singly or in combination, and either method, in theory, may be used at the operating frequency of the transmitter or at some other frequency with the signal at the operating frequency being obtained through the use of frequency changers (mixers).

The Filter Method The filter method for obtaining a SSB signal is the classic method which has been in use by the telephone companies for many years both for

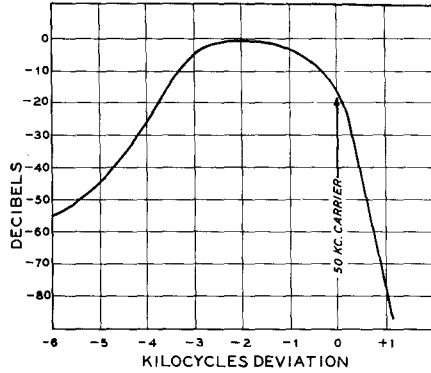

Figure 15
BANDPASS CHARACTERISTIC OF BURNELL S-15000 SINGLE SIDE BAND FILTER

land-line and radio communications. The mode of operation of the filter method is diagrammed in figure 14, in terms of components and filters which normally would be available to the amateur or experimenter. The output of the speech amplifier passes through a conventional speech filter to limit the frequency range of the speech to about 200 to 3000 cycles. This signal then is fed to a balanced modulator along with a 50,000-cycle first carrier from a self-excited oscillator. A low-frequency balanced modulator of this type most conveniently may be made up of four diodes of the vacuum or crystal type cross connected in a balanced bridge or ring modulator circuit. Such a modulator passes only the sideband components resulting from the sum and difference between the two signals being fed to the balanced modulator. The audio signal and the 50-kc. carrier signal from the oscillator both cancel out in the balanced modulator so that a band of frequencies between 47 and 50 kc. and another band of frequencies between 50 and 53 kc. appear in the output.

The signals from the first balanced modulator are then fed through the most critical

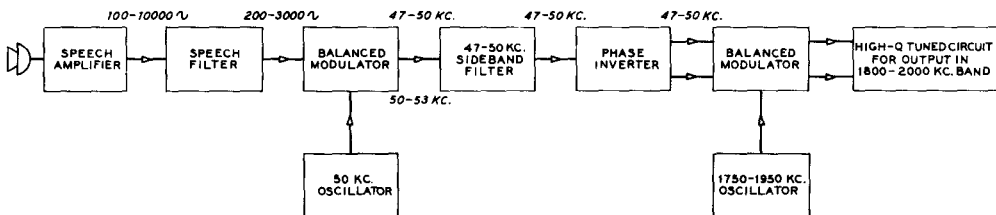

Figure 14
BLOCK DIAGRAM OF FILTER EXCITER EMPLOYING A 50-K.C. SIDEBAND FILTER

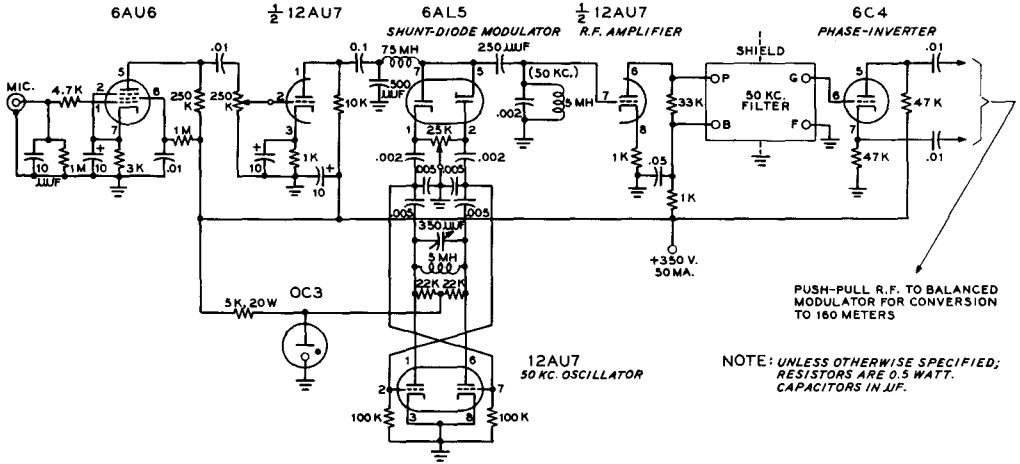

Figure 16
OPERATIONAL CIRCUIT FOR SSB EXCITER USING THE BURNELL
50-KC. SIDEBAND FILTER

component in the whole system—the first sideband filter. It is the function of this first sideband filter to separate the desired 47 to 50 kc. sideband from the unneeded and undesired 50 to 53 kc. sideband. Hence this filter must have low attenuation in the region between 47 and 50 kc., a very rapid slope in the vicinity of 50 kc., and a very high attenuation to the sideband components falling between 50 and 53 kilocycles.

Burnell & Co., Inc., of Yonkers, New York produce such a filter, designated as *Burnell S-15,000*. The passband of this filter is shown in figure 15.

Appearing, then, at the output of the filter is a single sideband of 47 kc. to 50 kc. This sideband may be passed through a phase inverter to obtain a balanced output, and then fed to a balanced mixer. A local oscillator operating in the range of 1750 kc. to 1950 kc. is used as the conversion oscillator. Additional conversion stages may now be added to trans-

late the SSB signal to the desired frequency. Since only linear amplification may be used, it is not possible to use frequency multiplying stages. Any frequency changing must be done by the beating-oscillator technique. An operational circuit of this type of SSB exciter is shown in figure 16.

A second type of filter-exciter for SSB may be built around the *Collins Mechanical Filter*. Such an exciter is diagrammed in figure 17. Voice frequencies in the range of 200-3000 cycles are amplified and fed to a low impedance phase-inverter to furnish balanced audio. This audio, together with a suitably chosen r-f signal, is mixed in a ring modulator, made up of small germanium diodes. Depending upon the choice of frequency of the r-f oscillator, either the upper or lower sideband may be applied to the input of the mechanical filter. The carrier, to some extent, has been rejected by the ring modulator. Additional carrier rejection is afforded by the excellent passband

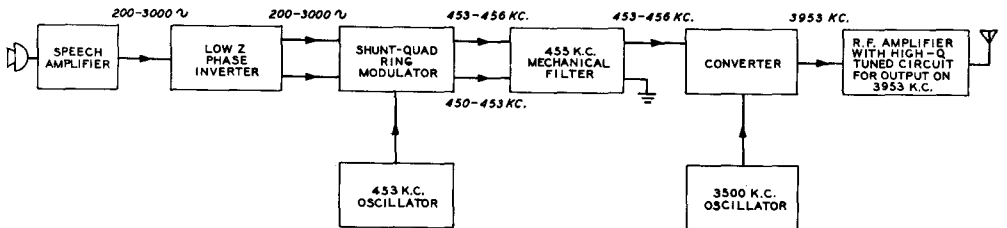
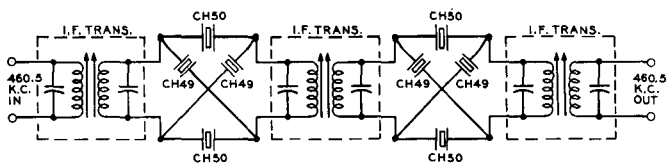
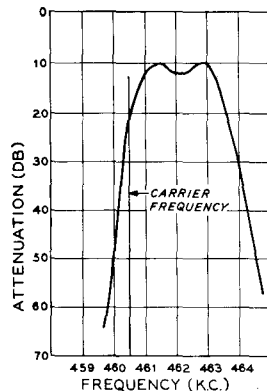

Figure 17
BLOCK DIAGRAM OF FILTER EXCITER EMPLOYING A 455-KC.
MECHANICAL FILTER FOR SIDEBAND SELECTION



FT-241 CHANNEL 49 CRYSTAL = 461.1 KC.
 FT-241 CHANNEL 50 CRYSTAL = 462.9 KC.

Figure 18
 SIMPLE CRYSTAL LATTICE FILTER



characteristics of the mechanical filter. For simplicity, the mixing and filtering operation usually takes place at a frequency of 455 kilocycles. The single-sideband signal appearing at the output of the mechanical filter may be translated directly to a higher operating frequency. Suitable tuned circuits must follow the conversion stage to eliminate the signal from the conversion oscillator.

Wave Filters The heart of a filter-type SSB exciter is the sideband filter. Conventional coils and capacitors may be used to construct a filter based upon standard wave filter techniques. The Q of the filter inductances must be high when compared with the reciprocal of the fractional bandwidth. If a bandwidth of 3 kc. is needed at a carrier frequency of 50 kc., the bandwidth expressed in terms of the carrier frequency is $3/50$ or 6%. This is expressed in terms of fractional bandwidth as $1/16$. For satisfactory operation, the

Q of the filter inductances should be 10 times the reciprocal of this, or 160. Appropriate Q is generally obtained from toroidal inductances, though there is some possibility of using iron core solenoids between 10 kc. and 20 kc. A characteristic impedance below 1000 ohms should be selected to prevent distributed capacity of the inductances from spoiling overall performance. Paper capacitors intended for bypass work may not be trusted for stability or low loss and should not be used in filter circuits. Care should be taken that the levels of both accepted and rejected signals are low enough so that saturation of the filter inductances does not occur.

Crystal Filters The best known filter responses have been obtained with crystal filters. Types designed for program carrier service cut-off 80 db in less than 50 cycles. More than 80 crystals are used in this type of filter. The crystals are cut to control reactance and resistance as well as the resonant frequency. The circuits used are based on full lattices.

The war-surplus low frequency crystals may be adapted to this type of filter with some success. Experimental designs usually synthesize a selectivity curve by grouping sharp notches at the side of the passband. Where the width of the passband is greater than twice the spacing of the series and parallel resonance of the crystals, special circuit techniques must be used. A typical crystal filter using these surplus crystals, and its approximate passband is shown in figure 18.

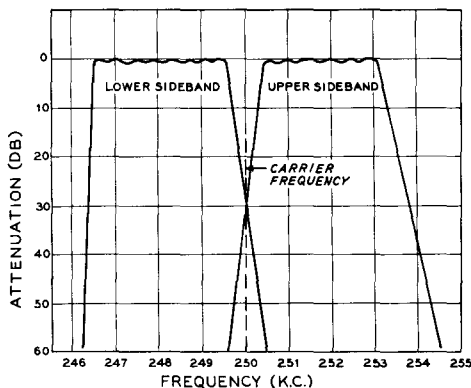

Figure 19
 PASSBAND OF LOWER AND UPPER
 SIDEBAND MECHANICAL FILTER

Mechanical Filters Filters using mechanical resonators have been studied by a number of companies and are offered commercially by the *Collins Radio Co.* They are available in a variety of bandwidths

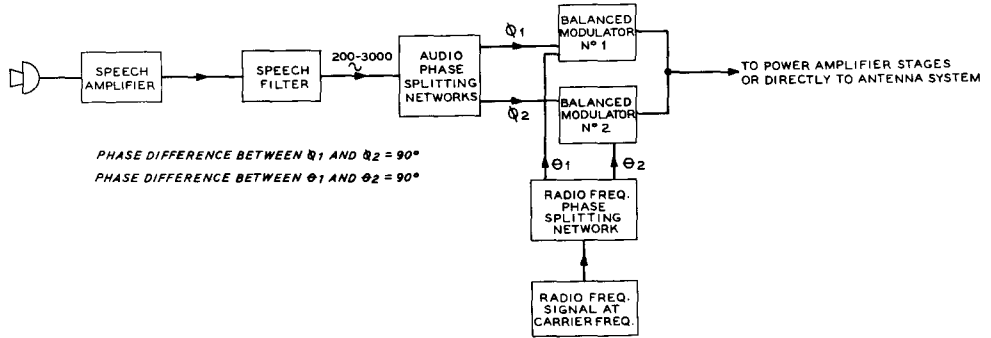

Figure 20
BLOCK DIAGRAM OF THE "PHASING" METHOD

The phasing method of obtaining a single-sideband signal is simpler than the filter system in regard to the number of tubes and circuits required. The system is also less expensive in regard to the components required, but is more critical in regard to adjustments for the transmission of a pure single-sideband signal.

at center frequencies of 250 kc. and 455 kc. The 250 kc. series is specifically intended for sideband selection. The selectivity attained by these filters is intermediate between good LC filters at low center frequencies and engineered quartz crystal filters. A passband of two 250 kc. filters is shown in figure 19. In application of the mechanical filters some special precautions are necessary. The driving and pick-up coils should be carefully resonated to the operating frequency. If circuit capacities are unknown, trimmer capacitors should be used across the coils. Maladjustment of these tuned coils will increase insertion loss and the peak-to-valley ratio. On high impedance filters (ten to twenty thousand ohms) signals greater than 2 volts at the input should be avoided. D-c should be blocked out of the end coils. While the filters are rated for 5 ma. of coil current, they are not rated for d-c plate voltage.

The Phasing System There are a number of points of view from which the operation of the phasing system of SSB generation may be described. We may state that we generate two double-sideband suppressed carrier signals, each in its own balanced modulator, that both the r-f phase and the audio phase of the two signals differ by 90 degrees, and that the outputs of the two balanced modulators are added with the result that one sideband is increased in amplitude and the other one is cancelled. This, of course, is a true description of the action that takes place. But it is much easier to consider the phasing system as a method simply of adding (or of subtracting) the desired modulation frequency and the nominal carrier frequency. The carrier frequency of course is not trans-

mitted, as is the case with all SSB transmissions, but only the sum or the difference of the modulation band from the nominal carrier is transmitted (figure 20).

The phasing system has the obvious advantage that all the electrical circuits which give rise to the single sideband can operate in a practical transmitter at the nominal output frequency of the transmitter. That is to say that if we desire to produce a single sideband whose nominal carrier frequency is 3.9 Mc., the balanced modulators are fed with a 3.9-Mc. signal and with the audio signal from the phase splitters. It is not necessary to go through several frequency conversions in order to obtain a sideband at the desired output frequency, as in the case with the filter method of sideband generation.

Assuming that we feed a speech signal to the balanced modulators along with the 3900-kc. carrier (3.9 Mc.) we will obtain in the output of the balanced modulators a signal which is either the sum of the carrier signal and the speech band, or the difference between the carrier and the speech band. Thus if our speech signal covers the band from 200 to 3000 cycles, we will obtain in the output a band of frequencies from 3900.2 to 3903 kc. (the sum of the two, or the "upper" sideband), or a band from 3897 to 3899.8 kc. (the difference between the two or the "lower" sideband). A further advantage of the phasing system of sideband generation is the fact that it is a very simple matter to select either the upper sideband or the lower sideband for transmission. A simple double-pole double-throw reversing switch in two of the four audio leads to the balanced modulators is all that is required.

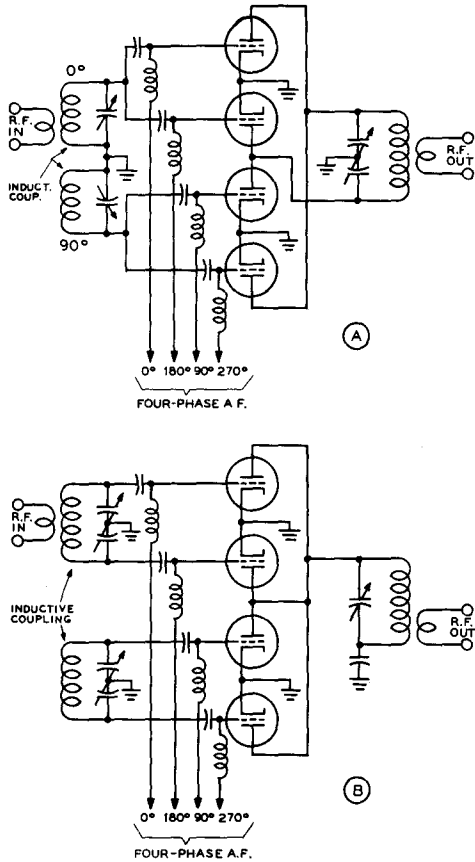

Figure 21
TWO CIRCUITS FOR SINGLE
SIDE BAND GENERATION BY THE
PHASING METHOD.

The circuit of (A) offers the advantages of simplicity in the single-ended input circuits plus a push-pull output circuit. Circuit (B) requires double-ended input circuits but allows all the plates to be connected in parallel for the output circuit.

High-Level Phasing Vs. Low-Level Phasing

The plate-circuit efficiency of the four tubes usually used to make up the two balanced modulators

of the phasing system may run as high as 50 to 70 per cent, depending upon the operating angle of plate current flow. Hence it is possible to operate the double balanced modulator directly into the antenna system as the output stage of the transmitter.

The alternative arrangement is to generate the SSB signal at a lower level and then to amplify this signal to the level desired by means of class A or class B r-f power amplifiers. If the SSB signal is generated at a level

of a few milliwatts it is most common to make the first stage in the amplifier chain a class A amplifier, then to use one or more class B linear amplifiers to bring the output up to the desired level.

Balanced Modulator Circuits

Illustrated in figure 8 are the two basic balanced modulator circuits which give good results with a radio frequency carrier and an audio modulating signal. Note that one push-pull and one single ended tank circuit is required, but that the push-pull circuit may be placed either in the plate or the grid circuit. Also, the audio modulating voltage always is fed into the stage in push-pull, and the tubes normally are operated Class A.

When combining two balanced modulators to make up a double balanced modulator as used in the generation of an SSB signal by the phasing system, only one plate circuit is required for the two balanced modulators. However, separate grid circuits are required since the grid circuits of the two balanced modulators operate at an r-f phase difference of 90 degrees. Shown in figure 21 are the two types of double balanced modulator circuits used for generation of an SSB signal. Note that the circuit of figure 21A is derived from the balanced modulator of figure 8A, and similarly figure 21B is derived from figure 8B.

Another circuit that gives excellent performance and is very easy to adjust is shown in figure 22. The adjustments for carrier balance are made by adjusting the potentiometer for voltage balance and then the small variable capacitor for exact phase balance of the balanced carrier voltage feeding the diode modulator.

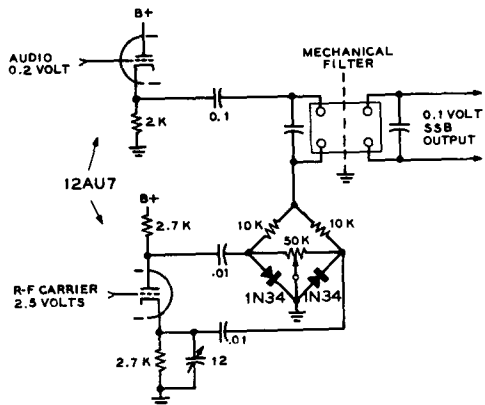

Figure 22
BALANCED MODULATOR FOR USE
WITH MECHANICAL FILTER

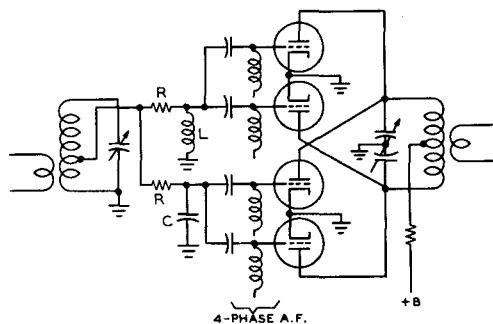

Figure 23
LOW-Q R-F PHASE-SHIFT NETWORK
The r-f phase-shift system illustrated above is convenient in a case where it is desired to make small changes in the operating frequency of the system without the necessity of being precise in the adjustment of two coupled circuits as used for r-f phase shift in the circuit of figure 21.

Radio-Frequency Phasing

A single-sideband generator of the phasing type requires that the two balanced modulators be fed with r-f signals having a 90-degree phase difference. This r-f phase difference may be obtained through the use of two loosely coupled resonant circuits, such as illustrated in figures 21A and 21B. The r-f signal is coupled directly or inductively to one of the tuned circuits, and the coupling between the two circuits is varied until, at resonance of both circuits, the r-f voltages developed across each circuit have the same amplitude and a 90-degree phase difference.

The 90-degree r-f phase difference also may be obtained through the use of a low-Q phase shifting network, such as illustrated in figure 23; or it may be obtained through the use of a lumped-constant quarter-wave line. The low-Q phase-shifting system has proved quite practicable for use in single-sideband systems, particularly on the lower frequencies. In such an arrangement the two resistances R have the same value, usually in the range between 100 and a few thousand ohms. Capacitor C, in shunt with the input capacitances of the tubes and circuit capacitances, has a reactance at the operating frequency equal to the value of the resistor R. Also, inductor L has a net inductive reactance equal in value at the operating frequency to resistance R.

The inductance chosen for use at L must take into account the cancelling effect of the input capacitance of the tubes and the circuit capacitance; hence the inductance should be

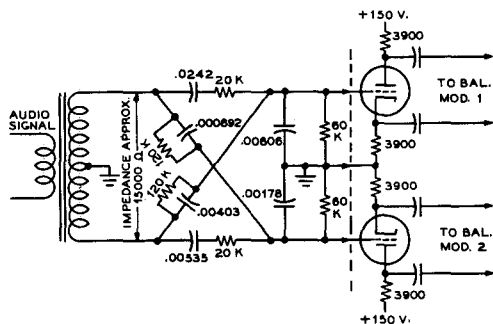

Figure 24
DOMES AUDIO-PHASE-SHIFT NETWORK
This circuit arrangement is convenient for obtaining the audio phase shift when it is desired to use a minimum of circuit components and tube elements.

variable and should have a lower value of inductance than that value of inductance which would have the same reactance as resistor R. Inductor L may be considered as being made up of two values of inductance in parallel; (a) a value of inductance which will resonate at the operating frequency with the circuit and tube capacitances, and (b) the value of inductance which is equal in reactance to the resistance R. In a network such as shown in figure 23, equal and opposite 45-degree phase shifts are provided by the RL and RC circuits, thus providing a 90-degree phase difference between the excitation voltages applied to the two balanced modulators.

Audio-Frequency Phasing

The audio-frequency phase-shifting networks used in generating a single-sideband signal by the phasing method usually are based on those described by Dome in an article in the December, 1946, *Electronics*. A relatively simple network for accomplishing the 90-degree phase shift over the range from 160 to 3500 cycles is illustrated in figure 24. The values of resistance and capacitance must be carefully checked to insure minimum deviation from a 90-degree phase shift over the 200 to 3000 cycle range.

Another version of the Dome network is shown in figure 25. This network employs three 12AU7 tubes and provides balanced output for the two balanced modulators. As with the previous network, values of the resistances within the network must be held to very close tolerances. It is necessary to restrict the speech range to 300 to 3000 cycles with this network. Audio frequencies outside this range will not have the necessary phase-shift at the output

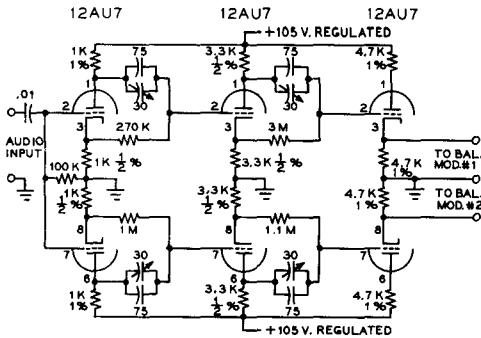

Figure 25
A VERSION OF THE DOME
AUDIO-PHASE-SHIFT
NETWORK

of the network and will show up as spurious emissions on the sideband signal, and also in the region of the rejected sideband. A low-pass 3500 cycle speech filter, such as the *Chicago Transformer Co. LPF-2* should be used ahead of this phase-shift network.

A passive audio phase-shift network that employs no tubes is shown in figure 26. This network has the same type of operating restrictions as those described above. Additional information concerning phase-shift networks will be found in *Single Sideband Techniques* published by the Cowan Publishing Corp., New York, and *The Single Sideband Digest* published by the American Radio Relay League. A comprehensive sideband review is contained in the December, 1956 issue of *Proceedings of the I.R.E.*

Comparison of Filter and Phasing Methods of SSB Generation Either the filter or the phasing method of single-sideband generation is theoretically capable of a high degree of performance.

In general, it may be said that a high degree of unwanted signal rejection may be attained with less expense and circuit complexity with the filter method. The selective circuits for rejection of unwanted frequencies operate at a relatively low frequency, are designed for this one frequency and have a relatively high order of Q. Carrier rejection of the order of 50 db or so may be obtained with a relatively simple filter and a balanced modulator, and unwanted sideband rejection in the region of 60 db is economically possible.

The phasing method of SSB generation exchanges the problems of high-Q circuits and linear amplification for the problems of accurately controlled phase-shift networks. If the

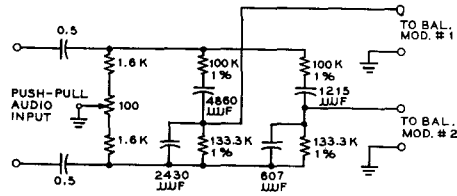

Figure 26
PASSIVE AUDIO-PHASE-SHIFT
NETWORK, USEFUL OVER RANGE
OF 300 TO 3000 CYCLES.

phasing method is employed on the actual transmitting frequency, change of frequency must be accompanied by a corresponding re-balance of the phasing networks. In addition, it is difficult to obtain a phase balance with ordinary equipment within 2% over a band of audio frequencies. This means that carrier suppression is limited to a maximum of 40 db or so. However, when a relatively simple SSB transmitter is needed for spot frequency operation, a phasing unit will perform in a satisfactory manner.

Where a high degree of performance in the SSB exciter is desired, the filter method and the phasing method may be combined. Through the use of the phasing method in the first balanced modulator those undesired sideband components lying within 1000 cycles of the carrier may be given a much higher degree of rejection than is attainable with the filter method alone, with any reasonable amount of complexity in the sideband filter. Then the sideband filter may be used in its normal way to attain very high attenuation of all undesired sideband components lying perhaps further than 500 cycles away from the carrier, and to restrict the sideband width on the *desired* side of the carrier to the specified frequency limit.

17-5 Single Sideband Frequency Conversion Systems

In many instances the band of sideband frequencies generated by a low level SSB transmitter must be heterodyned up to the desired carrier frequency. In receivers the circuits which perform this function are called *converters* or *mixers*. In sideband work they are usually termed *mixers* or *modulators*.

Mixer Stages One circuit which can be used for this purpose employs a receiving-type mixer tube, such as the 6BE6. The output signal from the SSB generator is fed into the #1 grid and the conversion fre-

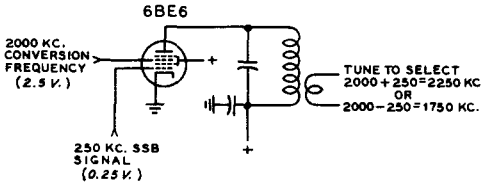

Figure 27
PENTAGRID MIXER CIRCUIT FOR SSB FREQUENCY CONVERSION

quency into the #3 grid. This is the reverse of the usual grid connections, but it offers about 10 db improvement in distortion. The plate circuit is tuned to select the desired output frequency product. Actually, the output of the mixer tube contains all harmonics of the two input signals and all possible combinations of the sum and difference frequencies of all the harmonics. In order to avoid distortion of the SSB signal, it is fed to the mixer at a low level, such as 0.1 to 0.2 volts. The conversion frequency is fed in at a level about 20 db higher, or about 2 volts. By this means, harmonics of the incoming SSB signal generated in the mixer tube will be very low. Usually the desired output frequency is either the sum or the difference of the SSB generator carrier frequency and the conversion frequency. For example, using a SSB generator carrier frequency of 250 kc. and a conversion injection frequency of 2000 kc. as shown in figure 27, the output may be tuned to select either 2250 kc. or 1750 kc.

Not only is it necessary to select the desired mixing product in the mixer output but also the undesired products must be highly attenuated to avoid having spurious output signals from the transmitter. In general, all spurious signals that appear within the assigned frequency channel should be at least 60 db below the desired signal, and those appearing outside of the assigned frequency channel at least 80 db below the signal level.

When mixing 250 kc. with 2000 kc. as in the above example, the desired product is the 2250 kc. signal, but the 2000 kc. injection frequency will appear in the output about 20 db stronger than the desired signal. To reduce it to a level 80 db below the desired signal means that it must be attenuated 100 db.

The principal advantage of using balanced modulator mixer stages is that the injection frequency theoretically does not appear in the output. In practice, when a considerable frequency range must be tuned by the balanced modulator and it is not practical to trim the

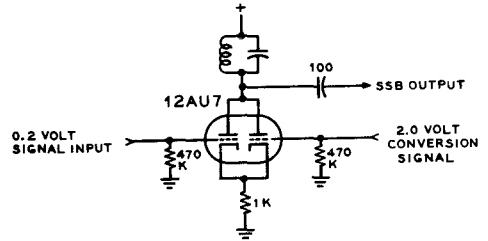

Figure 28
TWIN TRIODE MIXER CIRCUIT FOR SSB FREQUENCY CONVERSION

push-pull circuits and the tubes into exact amplitude and phase balance, about 20 db of injection frequency cancellation is all that can be depended upon. With suitable trimming adjustments the cancellation can be made as high as 40 db, however, in fixed frequency circuits.

The Twin Triode Mixer The mixer circuit shown in figure 28 has about 10 db lower distortion than the conventional 6BE6 converter tube. It has a lower voltage gain of about unity and a lower output impedance which loads the first tuned circuit and reduces its selectivity. In some applications the lower gain is of no consequence but the lower distortion level is important enough to warrant its use in high performance equipment. The signal-to-distortion ratio of this mixer is of the order of 70 db compared to approximately 60 db for a 6BE6 mixer when the level of each of two tone signals is 0.5 volt. With stronger signals, the 6BE6 distortion increases very rapidly, whereas the 12AU7 distortion is much better comparatively.

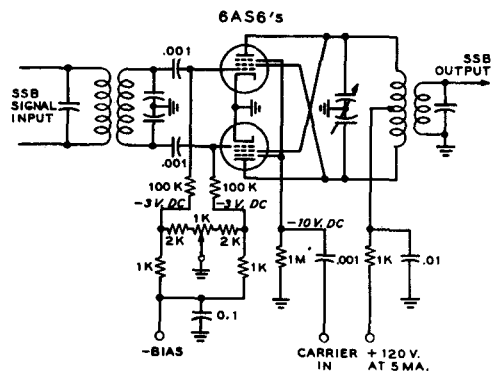

Figure 29
BALANCED MODULATOR CIRCUIT FOR SSB FREQUENCY CONVERSION

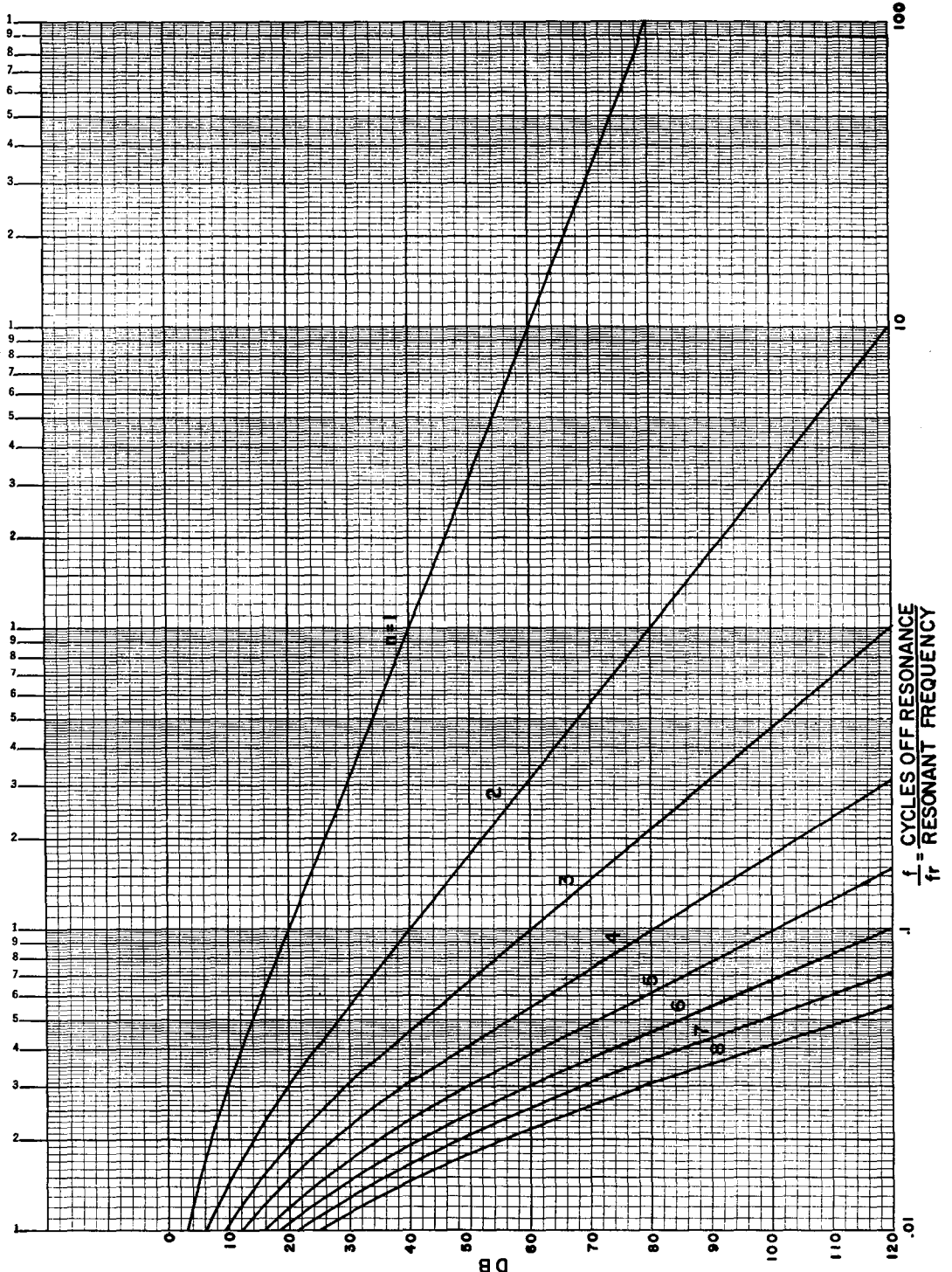

Figure 30
 RESPONSE OF "N" NUMBER OF TUNED CIRCUITS,
 ASSUMING EACH CIRCUIT Q IS 50

In practical equipment where the injection frequency is variable and trimming adjustments and tube selection cannot be used, it may be easier and more economical to obtain this extra 20 db of attenuation by using an extra tuned circuit in the output than by using a balanced modulator circuit. A balanced modulator circuit of interest is shown in figure 29, providing a minimum of 20 db of carrier attenuation with no balancing adjustment.

Selective Tuned Circuits The selectivity requirements of the tuned circuits following a mixer stage often become quite severe. For example, using an input signal at 250 kc. and a conversion injection frequency of 4000 kc. the desired output may be 4250 kc. Passing the 4250 kc. signal and the associated sidebands without attenuation and realizing 100 db of attenuation at 4000 kc. (which is only 250 kc. away) is a practical example. Adding the requirement that this selective circuit must tune from 2250 kc. to 4250 kc. further complicates the basic requirement. The best solution is to cascade a number of tuned circuits. Since a large number of such circuits may be required, the most practical solution is to use permeability tuning, with the circuits tracked together. An example of such circuitry is found in the *Collins KWS-1* sideband transmitter.

If an amplifier tube is placed between each tuned circuit, the overall response will be the sum of one stage multiplied by the number of stages (assuming identical tuned circuits). Figure 30 is a chart which may be used to determine the number of tuned circuits required for a certain degree of attenuation at some nearby frequency. The Q of the circuits is assumed to be 50, which is normally realized in small permeability tuned coils. The number of tuned circuits with a Q of 50 required for providing 100 db of attenuation at 4000 kc. while passing 4250 kc. may be found as follows:

$$\Delta f \text{ is } 4250 - 4000 = 250 \text{ kc.}$$

$$f_r \text{ is the resonant frequency, } 4250 \text{ kc.}$$

$$\text{and } \frac{\Delta f}{f_r} = \frac{250}{4250} = 0.059$$

The point on the chart where .059 intersects 100 db is between the curves for 6 and 7 tuned circuits, so 7 tuned circuits are required.

Another point which must be considered in practice is the tuning and tracking error of the circuits. For example, if the circuits were

actually tuned to 4220 kc. instead of 4250 kc., the $\frac{\Delta f}{f_r}$ would be $\frac{220}{4220}$ or 0.0522. Checking the curves shows that 7 circuits would just barely provide 100 db of attenuation. This illustrates the need for very accurate tuning and tracking in circuits having high attenuation properties.

Coupled Tuned Circuits When as many as 7 tuned circuits are required for proper attenuation, it is not necessary to have the gain that 6 isolating amplifier tubes would provide. Several vacuum tubes can be eliminated by using two or three coupled circuits between the amplifiers. With a coefficient of coupling between circuits 0.5 of critical coupling, the overall response is very nearly the same as isolated circuits. The gain through a pair of circuits having 0.5 coupling is only eight-tenths that of two critically coupled circuits, however. If critical coupling is used between two tuned circuits, the nose of the response curve is broadened and about 6 db is lost on the skirts of each pair of critically coupled circuits. In some cases it may be necessary to broaden the nose of the response curve to avoid adversely affecting the frequency response of the desired passband. Another tuned circuit may be required to make up for the loss of attenuation on the skirts of critically coupled circuits.

Frequency Conversion Problems The example in the previous section shows the difficult selectivity problem encountered when strong undesired signals appear near the desired frequency. A high frequency SSB transmitter may be required to operate at any carrier frequency in the range of 1.75 Mc. to 30 Mc. The problem is to find a practical and economical means of heterodyning the generated SSB frequency to any carrier frequency in this range. There are many modulation products in the output of the mixer and a frequency scheme must be found that will not have undesired output of appreciable amplitude at or near the desired signal. When tuning across a frequency range some products may "cross over" the desired frequency. These undesired crossover frequencies should be at least 60 db below the desired signal to meet modern standards. The amplitude of the undesired products depends upon the particular characteristics of the mixer and the particular order of the product. In general, most products of the 7th order and higher will be at least 60 db down. Thus any cross-

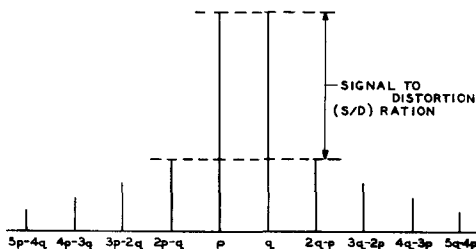

Figure 31
SSB DISTORTION PRODUCTS,
SHOWN UP TO NINTH ORDER

over frequency lower than the 7th must be avoided since there is no way of attenuating them if they appear within the desired pass-band. The *General Electric Ham News*, volume 11 #6 of Nov.-Dec., 1956 covers the subject of spurious products and incorporates a "mix-selector" chart that is useful in determining spurious products for various different mixing schemes.

In general, for most applications when the intelligence bearing frequency is lower than the conversion bearing frequency, it is desirable that the ratio of the two frequencies be between 5 to 1 and 10 to 1. This is a compromise between avoiding low order harmonics of this signal input appearing in the output, and minimizing the selectivity requirements of the circuits following the mixer stage.

17-6 Distortion Products Due to Nonlinearity of R-F Amplifiers

When the SSB envelope of a *voice* signal is distorted, a great many new frequencies are generated. These represent all of the possible combinations of the sum and difference frequencies of all harmonics of the original frequencies. For purposes of test and analysis, two equal amplitude tones are used as the SSB audio source. Since the SSB radio frequency amplifiers use tank circuits, all distortion products are filtered out except those which lie close to the desired frequencies. These are all odd order products; third order, fifth order, etc.. The third order products are 2p-q and 2q-p where p and q represent the two SSB r-f tone frequencies. The fifth order products are 3p-2q and 3q-2p. These and some higher order products are shown in figure 31. It should be noted that the frequency spacings are always equal to the difference frequency of the two original tones. Thus when a SSB amplifier is badly over-

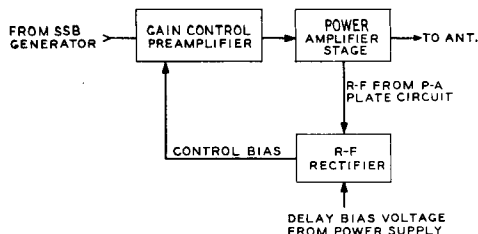

Figure 32
BLOCK DIAGRAM OF AUTOMATIC
LOAD CONTROL (A.L.C.) SYSTEM

loaded, these spurious frequencies can extend far outside the original channel width and cause an unintelligible "splatter" type of interference in adjacent channels. This is usually of far more importance than the distortion of the original tones with regard to intelligibility or fidelity. To avoid interference in another channel, these distortion products should be down at least 40 db below adjacent channel signal. Using a two-tone test, the distortion is given as the ratio of the amplitude of one test tone to the amplitude of a third order product. This is called the *signal-to-distortion ratio* (S/D) and is usually given in decibels. The use of feedback r-f amplifiers make S/D ratios of greater than 40 db possible and practical.

Automatic Load Control

Two means may be used to keep the amplitude of these distortion products down to acceptable levels. One is to design the amplifier for excellent linearity over its amplitude or power range. The other is to employ a means of limiting the amplitude of the SSB envelope to the capabilities of the amplifier. An *automatic load control system* (ALC) may be used to accomplish this result. It should be noted that the r-f wave shapes of the SSB signal are always sine waves because the tank circuits make them so. It is the *change in gain* with signal level in an amplifier that distorts the SSB envelope and generates unwanted distortion products. An ALC system may be used to limit the input signal to an amplifier to prevent a change in gain level caused by excessive input level.

The ALC system is adjusted so the power amplifier is operating near its maximum power capability and at the same time is protected from being over-driven. In amplitude modulated systems it is common to use speech compressors and speech clipping systems to perform this function. These methods are not

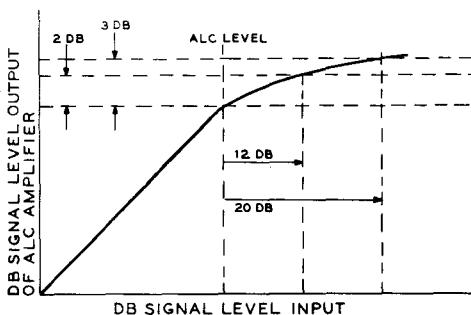

Figure 33
PERFORMANCE CURVE OF
A.L.C. CIRCUIT

equally useful in SSB. The reason for this is that the SSB envelope is different from the audio envelope and the SSB peaks do not necessarily correspond with the audio peaks as explained earlier in this chapter. For this reason a "compressor" of some sort located between the SSB generator and the power amplifier is most effective because it is controlled by SSB envelope peaks rather than audio peaks. Such a "SSB signal compressor" and the means of obtaining its control voltage comprises a satisfactory ALC system.

The ALC Circuit A block diagram of an ALC circuit is shown in figure 32. The compressor or gain control part of this circuit uses one or two stages of remote cutoff tubes such as 6BA6, operating very similarly to the intermediate frequency stages of a receiver having automatic volume control.

The grid bias voltage which controls the gain of the tubes is obtained from a voltage detector circuit connected to the power amplifier tube plate circuit. A large delay bias is used so that no gain reduction takes place until

the signal is nearly up to the full power capability of the amplifier. At this signal level, the rectified output overcomes the delay bias and the gain of the preamplifier is reduced rapidly with increasing signal so that there is very little rise in output power above the threshold of gain control.

When a signal peak arrives that would normally overload the power amplifier, it is desirable that the gain of the ALC amplifier be reduced in a few milliseconds to a value where overloading of the power amplifier is overcome. After the signal peak passes, the gain should return to the normal value in about one-tenth second. These attack and release times are commonly used for voice communications. For this type of work, a dynamic range of at least 10 db is desirable. Input peaks as high as 20 db above the threshold of compression should not cause loss of control although some increase in distortion in the upper range of compression can be tolerated because peaks in this range are infrequent. Another limitation is that the preceding SSB generator must be capable of passing signals above full power output by the amount of compression desired. Since the signal level through the SSB generator should be maintained within a limited range, it is unlikely that more than 12 db ALC action will be useful. If the input signal varies more than this, a speech compressor should be used to limit the range of the signal fed into the SSB generator.

Figure 33 shows the effectiveness of the ALC in limiting the output signal to the capabilities of the power amplifier. An adjustment of the delay bias will place the threshold of compression at the desired power output. Figure 34 shows a simplified schematic of an ALC system. This ALC uses two variable gain am-

Figure 34
SIMPLIFIED SCHEMATIC OF AUTOMATIC
LOAD CONTROL AMPLIFIER. OPERATING
POINT OF ALC
CIRCUIT MAY BE
SET BY VARYING
BLOCKING BIAS ON
CATHODE OF 6X4
SIGNAL RECTIFIER

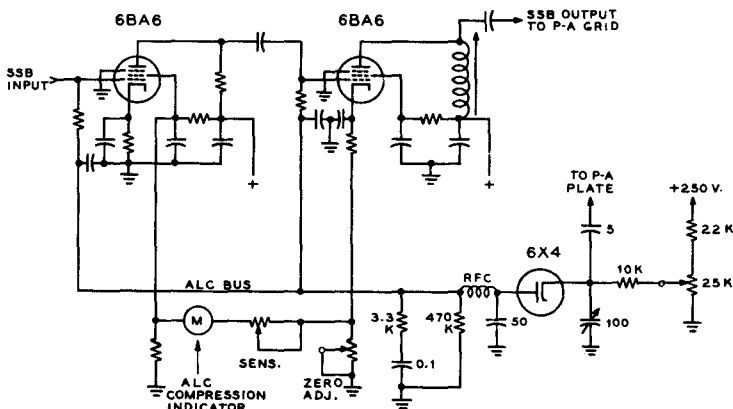

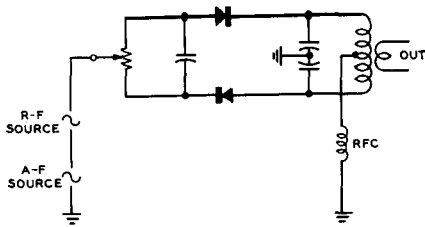

Figure 35
SSB JR. MODULATOR CIRCUIT
R-F and A-F sources are applied in series to balanced modulator.

plifier stages and the maximum overall gain is about 20 db. A meter is incorporated which is calibrated in db of compression. This is useful in adjusting the gain for the desired amount of load control. A capacity voltage divider is used to step down the r-f voltage at the plate of the amplifier tube to about 50 volts for the ALC rectifier. The output of the ALC rectifier passes through R-C networks to obtain the desired attack and release times

and through r-f filter capacitors. The 3.3K resistor and 0.1 μ fd. capacitor across the rectifier output stabilizes the gain around the ALC loop to prevent "motor-boating."

17-7 Sideband Exciters

Some of the most popular sideband exciters in use today are variations of the simple phasing circuit introduced in the November, 1950 issue of *General Electric Ham News*. Called the *SSB, Jr.*, this simple exciter is the basis for many of the phasing transmitters now in use. Employing only three tubes, the *SSB, Jr.* is a classic example of sideband generation reduced to its simplest form.

The SSB, Jr. This phasing exciter employs audio and r-f phasing circuits to produce a SSB signal at one spot frequency. The circuit of one of the balanced modulator stages is shown in figure 35. The audio signal and r-f source are applied in series to two germanium diodes serving as balanced modulators

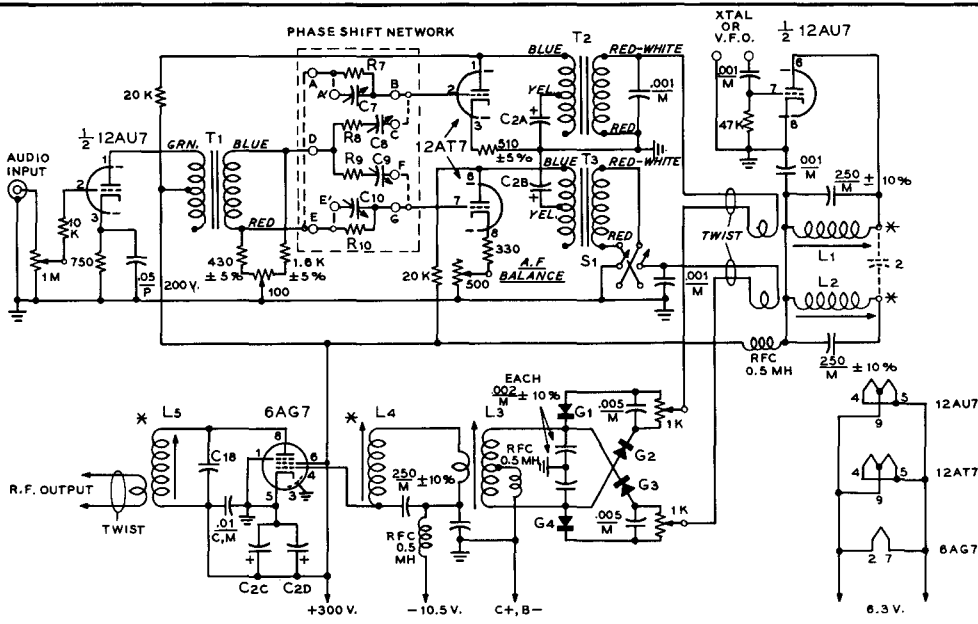

- C2A, B, C, D = EACH SECTION 20 μ F, 450 V. ELECTROLYTIC
- C7 = 2430 μ WFD (.002 μ F MICA $\pm 5\%$ WITH 170-780 μ WFD TRIMMER)
- C8 = 4860 μ WFD (.0043 μ F MICA $\pm 5\%$ WITH 170-780 μ WFD TRIMMER)
- C9 = 1215 μ WFD (.001 μ F MICA $\pm 5\%$ WITH 50-380 μ WFD TRIMMER)
- C10 = 607.5 μ WFD (500 μ WFD MICA $\pm 5\%$ WITH 5-180 μ WFD TRIMMER)
- C18 = 350 μ WFD 600V. MICA $\pm 10\%$ (250 μ WFD AND 100 μ WFD PARALLEL)
- R7, R10 = 133,300 OHMS, 1/2 WATT $\pm 1\%$
- R8, R9 = 100,000 OHMS, 1/2 WATT $\pm 1\%$
- T1 = STANCOR A-53C TRANSFORMER.
- T2, T3 = UTC R-38A TRANSFORMER.
- S1 = DPDT TOGGLE SWITCH
- G1, 2, 3, 4 = 1N52 GERMANIUM DIODE OR EQUIVALENT
- L1, L2 = 33 T. $\# 21$ E. WIRE CLOSEWOUND ON MILLEN $\# 69046$ IRON CORE ADJUSTABLE SLUG COIL FORM. LINK OF 6 TURNS OF HOOKUP WIRE WOUND ON OPEN END.
- L3 = 16 T. $\# 19$ E. WIRE SPACED TO FILL MILLEN $\# 69046$ COIL FORM. TAP AT 8 TURNS. LINK OF 1 TURN AT CENTER.
- L4 = SAME AS L1 EXCEPT NO LINK USED.
- L5 = 28 T. OF $\# 19$ E. WIRE. LINK ON END TO MATCH LOAD. (4 TURN LINK MATCHES 72 OHM LOAD)

Figure 36
SCHEMATIC, SSB, JR.

* = MOUNTING END OF COILS.

having a push-pull output circuit tuned to the r-f "carrier" frequency. The modulator drives a linear amplifier directly at the output frequency. The complete circuit of the exciter is shown in figure 36.

The first tube, a 12AU7, is a twin-triode serving as a speech amplifier and a crystal oscillator. The second tube is a 12AT7, acting as a twin channel audio amplifier following the phase-shift audio network. The linear amplifier stage is a 6AG7, capable of a peak power output of 5 watts.

Sideband switching is accomplished by the reversal of audio polarity in one of the audio channels (switch S_1), and provision is made for equalization of gain in the audio channels (R_{12}). This adjustment is necessary in order to achieve normal sideband cancellation, which may be of the order of 35 db or better. Phase-shift network adjustment may be achieved by adjusting potentiometer R_8 . Stable modulator balance is achieved by the balance potentiometers R_{16} and R_{17} in conjunction with the germanium diodes.

The SSB, Jr. is designed for spot frequency operation. Note that when changing frequency L_1 , L_2 , L_3 , L_4 , and L_5 should be readjusted, since these circuits constitute the tuning adjustments of the rig. The principal effect of mistuning L_3 , L_4 , and L_5 will be lower output. The principal effect of mistuning L_2 , however, will be degraded sideband suppression.

Power requirements of the SSB, Jr. are 300 volts at 60 ma., and -10.5 volts at 1 ma. Under load the total plate current will rise to about 80 ma. at full level with a single tone input. With speech input, the total current will rise from the resting value of 60 ma. to about 70 ma., depending upon the voice waveform.

The "Ten-A" Exciter The *Model 10-A* phasing exciter produced by *Central Electronics, Inc.* is an advanced version of the SSB, Jr. incorporating extra features such as VFO control, voice operation, and multi-band operation. A simplified schematic of the *Model 10A* is shown in figure 37. The 12AX7 two stage speech amplifier excites a transformer coupled $\frac{1}{2}$ -12BH7 low impedance driver stage and a voice operated (VOX) relay system employing a 12AX7 and a 6AL5. A transformer coupled 12AT7 follows the audio phasing network, providing two audio channels having a 90-degree phase difference. A simple 90-degree r-f phase shift network in the plate circuit of the 9 Mc. crys-

tal oscillator stage works into the matched, balanced modulator consisting of four 1N48 diodes.

The resulting 9 Mc. SSB signal may be converted to the desired operating frequency in a 6BA7 mixer stage. Eight volts of r-f from an external v-f-o injected on grid #1 of the 6BA7 is sufficient for good conversion efficiency and low distortion. The plate circuit of the 6BA7 is tuned to the sum or difference mixing frequency and the resulting signal is amplified in a 6AG7 linear amplifier stage. Two "tweet" traps are incorporated in the 6BA7 stage to reduce unwanted responses of the mixer which are apparent when the unit is operating in the 14 Mc. band. Band-changing is accomplished by changing coils L_8 and L_9 and the frequency of the external mixing signal. Maximum power output is of the order of 5 watts at any operating frequency.

A Simple 80 Meter Phasing Exciter A SSB exciter employing r-f and audio phasing circuits is shown in figure 38. Since the r-f phasing circuits are balanced only at one frequency of operation, the phasing exciter is necessarily a single frequency transmitter unless provisions are made to re-balance the phasing circuits every time a frequency shift is made. However for mobile operation, or spot frequency operation a relatively simple phasing exciter may be made to perform in a satisfactory manner.

A 12AU7 is employed as a Pierce crystal oscillator, operating directly on the chosen SSB frequency in the 80 meter band. The second section of this tube is used as an isolation stage, with a tuned plate circuit, L_1 . The output of the oscillator stage is link coupled to a 90° r-f phase-shift network wherein the audio signal from the audio phasing network is combined with the r-f signals. Carrier balance is accomplished by adjustment of the two 1000 ohm potentiometers in the r-f phase network. The output of the r-f phasing network is coupled through L_2 to a single 6CL6 linear amplifier which delivers a 3 watt peak SSB signal on 80 meters.

A cascade 12AT7 and a single 6C4 comprise the speech amplifier used to drive the audio phase shift network. A small inter-stage transformer is used to provide the necessary 180° audio phase shift required by the network. The output of the audio phasing network is coupled to a 12AU7 dual cathode follower which provides the necessary low impedance circuit to match the r-f phasing network. A double-

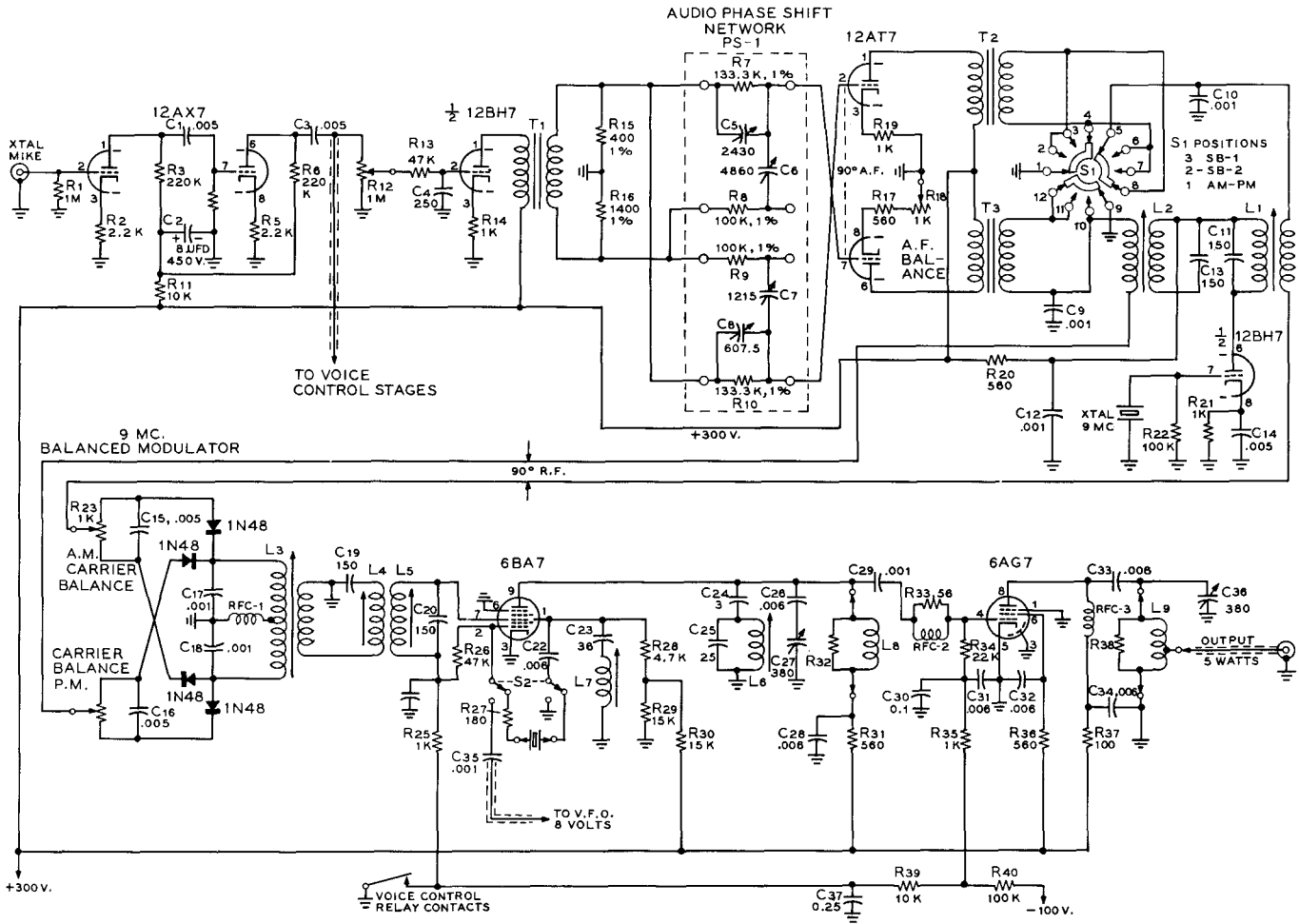

Figure 37
SIMPLIFIED SCHEMATIC OF "TEN-A" EXCITER

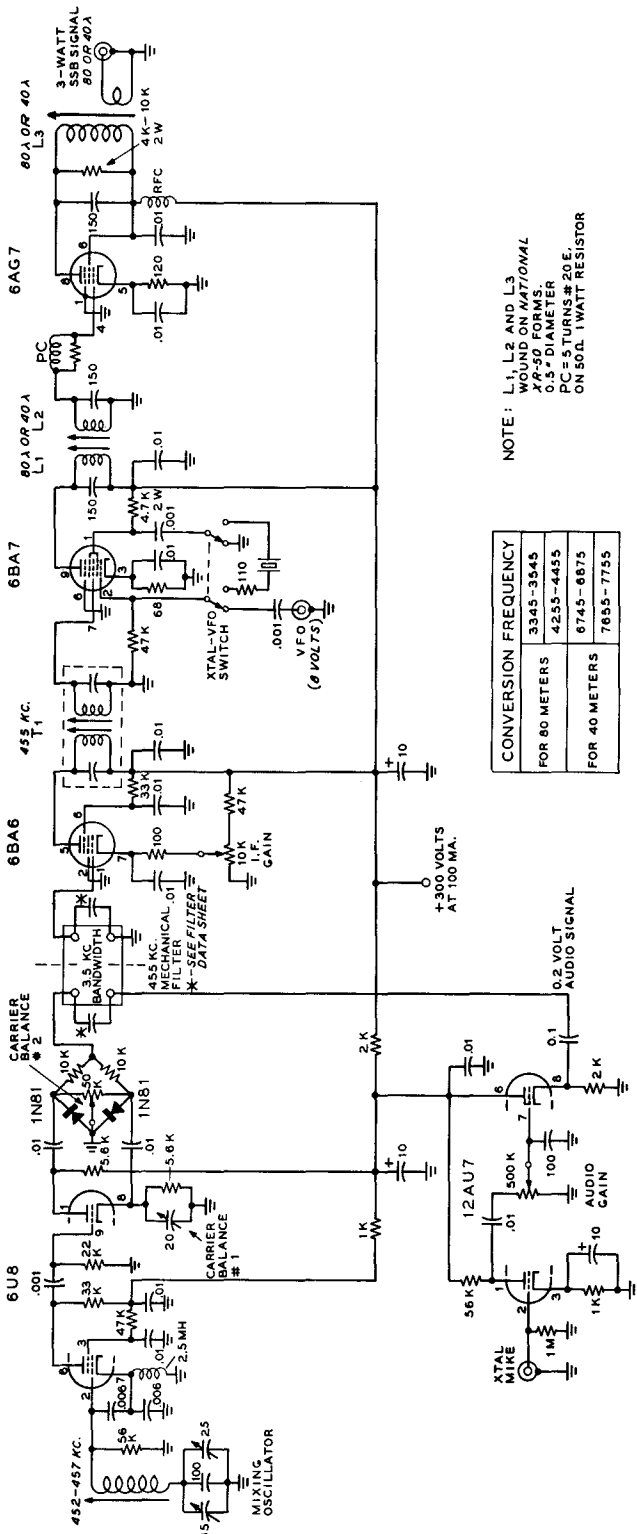

Figure 39
SCHEMATIC, FILTER-TYPE SSB EXCITER
FOR 80 OR 40 METER OPERATION

NOTE: L₁, L₂ AND L₃
 WOUND ON M477/OMAL
 XR-50 FORMS,
 0.5" DIAMETER,
 PC-5 TURNS #20 E,
 ON 50Ω 1 WATT RESISTOR

CONVERSION FREQUENCY
3345-3545
FOR 80 METERS
4255-4455
FOR 40 METERS
6745-6875
7655-7755

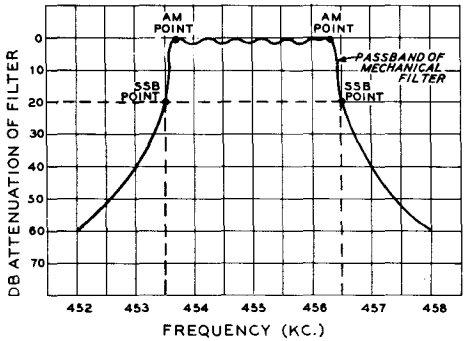

Figure 40
THE "TWENTY DB" CARRIER
POINTS ON THE FILTER CURVE
The beating oscillator should be adjusted so that its frequency corresponds to the 20 db attenuation points of the mechanical filter passband. The carrier of the SSB signal is thus attenuated 20 db in addition to the inherent carrier attenuation of the balanced mixer. A total carrier attenuation of 50 db is achieved. Unwanted sideband rejection is of the same order.

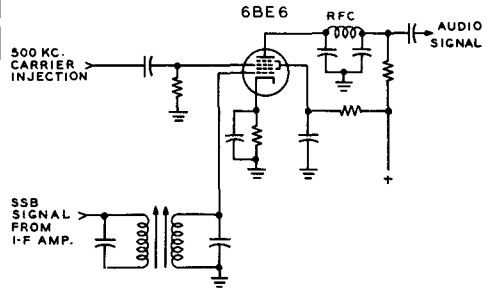
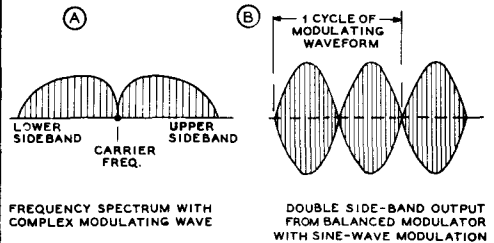

Figure 41
THE PRODUCT DETECTOR
The above configuration resembles pentagrid converter circuit.



FREQUENCY SPECTRUM WITH COMPLEX MODULATING WAVE

DOUBLE SIDE-BAND OUTPUT FROM BALANCED MODULATOR WITH SINE-WAVE MODULATION

Figure 42
DOUBLE-SIDE-BAND
SUPPRESSED-CARRIER SIGNAL
The envelope shown at B also is obtained on the oscilloscope when two audio frequencies of the same amplitude are fed to the input of a single-sideband transmitter.

transformer is placed between the mixer stage and the 6AG7 output stage. A maximum signal of 3 watts may be obtained from the 6AG7 linear amplifier.

Selection of the upper or lower sideband is accomplished by tuning the 6U8 beating oscillator across the passband of the mechanical filter, as shown in figure 40. If the 80 meter conversion oscillator is placed on the low frequency side of the SSB signal, placing the 6U8 beating oscillator on the low frequency side of the passband of the mechanical filter will produce the upper sideband on 80 meters. When the beating oscillator is placed on the high frequency side of the passband of the mechanical filter the lower sideband will be generated on 80 meters. If the 80 meter conversion oscillator is placed on the high frequency side of the SSB signal, the sidebands will be reversed from the above. The variable oscillator should be set at approximately the 20 db suppression point of the passband of the mechanical filter for best operation, as shown in figure 40. If the oscillator is closer in frequency to the filter passband than this, carrier rejection will suffer. If the oscillator is moved farther away in frequency from the passband, the lower voice frequencies will be attenuated, and the SSB signal will sound high-pitched and tinny. A little practice in setting the frequency of the beating oscillator while monitoring the 80 meter SSB signal in the station receiver will quickly acquaint the operator with the proper frequency setting of the beating oscillator control for transmission of either sideband.

If desired, an amplitude modulated signal with full carrier and one sideband may be transmitted by placing the 6U8 low frequency oscillator just inside either edge of the passband of the filter (designated "AM point", figure 40).

After the 6U8 oscillator is operating over the proper frequency range it should be possible to tune the beating oscillator tuning capacitor across the passband of the mechanical filter and obtain a reading on the S-meter of a receiver tuned to the filter frequency and coupled to the input grid of the 6BA6 i-f amplifier tube. The two carrier balance controls of the 6U8 phase inverter section should be adjusted for a null reading of the S-meter when the oscillator is placed in the center of the filter passband. The 6BA6 stage is now checked for operation, and transformed T₁ aligned to the carrier frequency. It may be necessary to unbalance temporarily potentiometer #2 of the 6U8 phase inverter in order to obtain a sufficiently strong signal for proper alignment of T₁.

meter #2 of the 6U8 phase inverter in order to obtain a sufficiently strong signal for proper alignment of T₁.

A conversion crystal is next plugged in the 6BA7 conversion oscillator circuit, and the operation of the oscillator is checked by monitoring the crystal frequency with a nearby receiver. The SSB "carrier" produced by the unbalance of potentiometer #2 should be heard at the proper sideband frequency in either the 80 meter or 40 meter band. The coupled circuit between the 6BA7 and the 6AG7 is resonated for maximum carrier voltage at the grid of the amplifier stage. Care should be taken that this circuit is tuned to the sideband frequency and not to the frequency of the conversion oscillator. Finally, the 6AG7 stage is tuned for maximum output. When these adjustments have been completed, the 455 kc. beating oscillator should be moved just out of the passband of the mechanical filter. The 80 meter "carrier" will disappear. If it does not, there is either energy leaking around the filter, or the amplifier stages are oscillating. Careful attention to shielding (and neutralization) should cure this difficulty.

Audio excitation is now applied to the exciter, and the S-meter of the receiver should kick up with speech, but the audio output of the receiver should be unintelligible. As the frequency of the beating oscillator is adjusted so as to bring the oscillator frequency within the passband of the mechanical filter the modulation should become intelligible. A single sideband a.m. signal is now being generated. The BFO of the receiver should now be turned on, and the beating oscillator of the exciter moved out of the filter passband. When the receiver is correctly tuned, clean, crisp speech should be heard. The oscillator should be set at one of the "20 decibel" points of the filter curve, as shown in figure 40 and all adjustments trimmed for maximum carrier suppression.

17-8 Reception of Single Sideband Signals

Single-sideband signals may be received, after a certain degree of practice in the technique, in a quite adequate and satisfactory manner with a good communications receiver. However, the receiver must have quite good frequency stability both in the high-frequency oscillator and in the beat oscillator. For this reason, receivers which use a crystal-controlled first oscillator are likely to offer a

greater degree of satisfaction than the more common type which uses a self-controlled oscillator.

Beat oscillator stability in most receivers is usually quite adequate, but many receivers do not have a sufficient amplitude of beat oscillator injection to allow reception of strong SSB signals without distortion. In such receivers it is necessary either to increase the amount of beat-oscillator injection into the diode detector, or the manual gain control of the receiver must be turned down quite low.

The tuning procedure for SSB signals is as follows: The SSB signals may first be located by tuning over the band with receiver set for the reception of c-w.; that is, with the manual gain at a moderate level and with the beat oscillator operating. By tuning in this manner SSB signals may be *located* when they are far below the amplitude of conventional AM signals on the frequency band. Then after a signal has been located, the beat oscillator should be turned off and the receiver put on a.v.c. Following this the receiver should be tuned for maximum swing of the S meter with modulation of the SSB signal. It will not be possible to understand the SSB signal at this time, but the receiver may be tuned for maximum deflection. Then the receiver is put back on manual gain control, the beat oscillator is turned on again, the manual gain is turned down until the background noise level is quite low, and the *beat oscillator* control is varied until the signal sounds natural.

The procedure in the preceding paragraph may sound involved, but actually all the steps except the last one can be done in a moment. However, the last step is the one which will require some practice. In the first place, it is not known in advance whether the upper or lower sideband is being transmitted. So it will be best to start tuning the beat oscillator from one side of the pass band of the receiver to the other, rather than starting with the beat oscillator near the center of the pass band as is normal for c-w reception.

With the beat oscillator on the wrong side of the sideband, the speech will sound inverted; that is to say that low-frequency modulation tones will have a high pitch and high-frequency modulation tones will have a low pitch—and the speech will be quite unintelligible. With the beat oscillator on the correct side of the sideband but too far from the correct position, the speech will have some intelligibility but the voice will sound quite high pitched. Then as the correct setting for the beat oscilla-

tor is approached the voice will begin to sound natural but will have a background growl on each syllable. At the correct frequency for the beat oscillator the speech will clear completely and the voice will have a clean, crisp quality. It should also be mentioned that there is a narrow region of tuning of the beat oscillator a small distance on the wrong side of the sideband where the voice will sound quite bassy and difficult to understand.

With a little experience it will be possible to identify the sound associated with improper settings of the beat-oscillator control so that corrections in the setting of the control can be made. Note that the main tuning control of the receiver is not changed after the sideband once is tuned into the pass band of the receiver. All the fine tuning should be done with the beat oscillator control. Also, it is very important that the r-f gain control be turned to quite a low level during the tuning process. Then after the signal has been tuned properly the r-f gain may be increased for good signal level, or until the point is reached where best oscillator injection becomes insufficient and the signal begins to distort.

Single-Sideband Receivers and Adapters

Greatly simplified tuning, coupled with strong attenuation of undesired signals, can be obtained through the use of a single-sideband receiver or receiver adapter. The exalted carrier principle usually is employed in such receivers, with a phase-sensitive system sometimes included for locking the local oscillator to the frequency of the carrier of the incoming signal. In order for the locking system to operate, some carrier must be transmitted along with the SSB signal. Such receivers and adapters include a means for selecting the upper or lower sideband by the simple operation of a switch. For the reception of a single-sideband signal the switch obviously must be placed in the correct position. But for the reception of a conventional AM or phase-modulated signal, either sideband may be selected, allowing the sideband with the least interference to be used.

The Product Detector An unusually satisfactory form of demodulator for SSB service is the *product detector*, shown in one form in figure 41. This circuit is preferred since it reduces intermodulation products and does not require a large local carrier voltage, as contrasted to the more common diode envelope detector. This product detector operates much in the same manner as

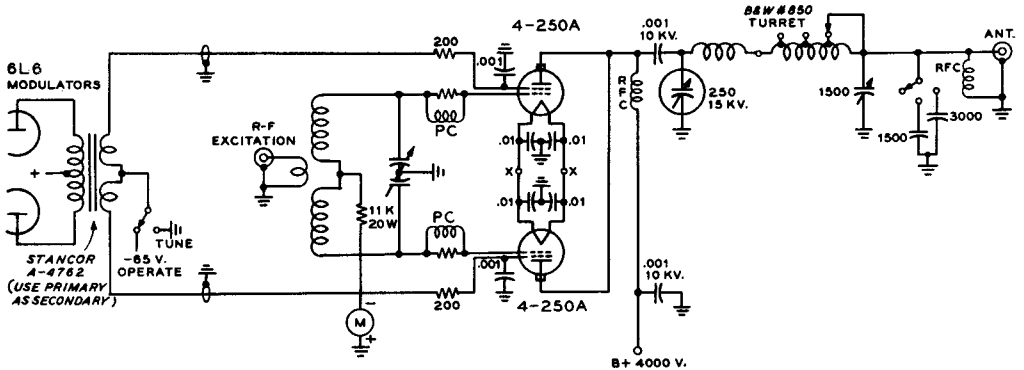

Figure 43
HIGH-LEVEL DSB BALANCED MODULATOR

a multi-grid mixer tube. The SSB signal is applied to the control grid of the tube and the locally generated carrier is impressed upon the other control grid. The desired audio output signal is recovered across the plate resistance of the demodulator tube. Since the cathode current of the tube is controlled by the simultaneous action of the two grids, the current will contain frequencies equal to the sum and difference between the sideband signal and the carrier. Other frequencies are suppressed by the low-pass r-f filter in the plate circuit of the stage, while the audio frequency is recovered from the i-f sideband signal.

17-9 Double Sideband Transmission

Many systems of intelligence transmission lie in the region between amplitude modulation on the one hand and single sideband suppressed-carrier transmission on the other hand. One system of interest to the amateur is the *Synchronous Communications System*, popularly known as "double sideband" (DSB) transmission, wherein a suppressed-carrier double sideband signal is transmitted (figure 42). Reception of such a signal is possible by utilizing a local oscillator phase-control system which derives carrier phase information from the sidebands alone and does not require the use of any pilot carrier.

The DSB Transmitter A balanced modulator of the type shown in figure 8 may be employed to create a DSB signal. For higher operating levels, a pair of class-C type tetrode amplifier tubes may be screen modulated by a push-pull audio system

and excited from a push-pull r-f source. The plates of such a modulator are connected in parallel to the tank circuit, as shown in figure 43. This DSB modulator is capable of 1-kilo-watt peak power output at a plate potential of 4000 volts. The circuit is self-neutralizing and the tune-up process is much the same as with any other class-C amplifier stage. As in the case of SSB, the DSB signal may also be generated at a low level and amplified in linear stages following the modulator.

Synchronous Detection A DSB signal may be received with difficulty on a conventional receiver, and one of the two sidebands may easily be received on a single sideband receiver. For best reception, however, a phase-locked local oscillator and a synchronous detector should be employed. This operation may be performed either at the frequency of reception or at a convenient intermediate frequency. A block dia-

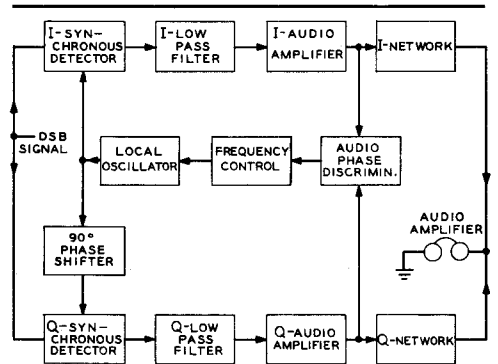

Figure 44
BLOCK DIAGRAM OF DSB RECEIVING ADAPTER

gram of a DSB synchronous receiver is shown in figure 44. The DSB signal is applied to two detectors having their local oscillator conversion voltages in phase quadrature to each other so that the audio contributions of the upper and lower sidebands reinforce one another. The *in-phase* oscillator voltage is adjusted to have the same phase as the suppressed carrier of the transmitted signal. The I-amplifier audio output, therefore, will contain the demodulated audio signal, while the Q-amplifier (supplied with *quadrature* oscillator voltage) will produce no output due to the quadrature null. Any frequency change of the local oscillator will produce some audio output in the Q-amplifier, while the I-amplifier is relatively unaffected. The Q-amplifier audio will have the same polarity as the I-channel audio for one direction of oscillator drift, and opposite polarity for oscillator drift in the opposite direction. The Q-amplifier signal level is proportional to the magnitude of the local oscillator phase angle error (the oscillator drift) for small errors. By combining the I-signal and the Q-signal in the audio phase discriminator a d-c control voltage is developed which automatically corrects for local oscillator phase er-

rors. The reactance tube therefore locks the local oscillator to the correct phase. Phase control information is derived entirely from the sideband component of the signal and the carrier (if present) is not employed. Phase control ceases with no modulation of the signal and is reestablished with the reappearance of modulation.

Interference Rejection Interference falling within the passband of the receiver can be reduced by proper combination of the I- and Q- audio signals. Under phase lock conditions, the I-signal is composed of the audio signal plus the undesired interference, whereas the Q-signal contains only the interference component. Phase cancellation obtained by combining the two signals will reduce the interference while still adding the desired information contained in both side-bands. The degree of interference rejection is dependent upon the ratio of interference falling upon the two sidebands of the received signal and upon the basic design of the audio networks. A schematic and description of a complete DSB receiving adapter is shown in the June, 1957 issue of *CQ* magazine.

E & E TECHNI-SHEET
AIRWOUND INDUCTORS

COIL DIA. INCHES	TURNS PER INCH	B & W	AIR DUX	INDUCTANCE UH	COIL DIA. INCHES	TURNS PER INCH	B & W	AIR DUX	INDUCTANCE UH
1/2	4	3001	404T	0.18	1 1/4	4	—	1004	2.75
	6	—	406T	0.40		6	—	1006	6.30
	8	3002	408T	0.72		8	—	1008	11.2
	10	—	410T	1.12		10	—	1010	17.5
	16	3003	416T	2.90		16	—	1016	42.5
5/8	32	3004	432T	12.0	1 1/2	4	—	1204	3.9
	4	3005	504T	0.28		6	—	1206	8.8
	6	—	506T	0.62		8	—	1208	15.6
	8	3006	508T	1.1		10	—	1210	24.5
	10	—	510T	1.7		16	—	1216	63.0
3/4	16	3007	516T	4.4	1 3/4	4	—	1404	5.2
	32	3008	532T	18.0		6	—	1406	11.8
	4	3009	604T	0.39		8	—	1408	21.0
	6	—	606T	0.87		10	—	1410	33.0
	8	3010	608T	1.57		16	—	1416	85.0
1	10	—	610T	2.45	2	4	—	1604	6.6
	16	3011	616T	6.40		6	—	1606	15.0
	32	3012	632T	26.0		8	3900	1608	26.5
	4	3013	804T	1.0		10	3907-1	1610	42.0
1	6	—	806T	2.3	2 1/2	16	—	1616	108.0
	8	3014	808T	4.2		4	—	2004	10.1
	10	—	810T	6.6		6	3905-1	2006	23.0
	16	3015	816T	16.8		8	3906-1	2008	41.0
	32	3016	832T	68.0		10	—	2010	108.0
NOTE: COIL INDUCTANCE APPROXIMATELY PROPORTIONAL TO LENGTH. I.E., FOR 1/2 INDUCTANCE VALUE, TRIM COIL TO 1/2 LENGTH.					3	4	—	2404	14.0
						6	—	2406	31.5
						8	—	2408	56.0
						10	—	2410	89.0

Transmitter Design

The excellence of a transmitter is a function of the design, and is dependent upon the execution of the design and the proper choice of components. This chapter deals with the study of transmitter circuitry and of the basic components that go to make up this circuitry. Modern components are far from faultless. Resistors have inductance and distributed capacity. Capacitors have inductance and resistance, and inductors have resistance and distributed capacity. None of these residual attributes show up on circuit diagrams, yet they are as much responsible for the success or failure of the transmitter as are the necessary and vital bits of resistance, capacitance and inductance. Because of these unwanted attributes, the job of translating a circuit on paper into a working piece of equipment often becomes an impossible task to those individuals who disregard such important trivia. Rarely do circuit diagrams show such pitfalls as ground loops and residual inductive coupling between stages. Parasitic resonant circuits are rarely visible from a study of the schematic. Too many times radio equipment is rushed into service before it has been entirely checked. The immediate and only too apparent results of this enthusiasm are transmitter instability, difficulty of neutralization, r.f. wandering all over the equipment, and a general "touchiness" of adjustment. Hand in glove with these problems go the more serious ones of TVI, key-clicks, and parasitics. By paying

attention to detail, with a good working knowledge of the limitations of the components, and with a basic conception of the actions of ground currents, the average amateur will be able to build equipment that will work "just like the book says."

The twin problems of TVI and parasitics are an outgrowth of the major problem of overall circuit design. If close attention is paid to the cardinal points of circuitry design, the secondary problems of TVI and parasitics will in themselves be solved.

18-1

Resistors

The resistance of a conductor is a function of the material, the form the material takes, the temperature of operation, and the frequency of the current passing through the resistance. In general, the variation in resistance due to temperature is directly proportional to the temperature change. With most wire-wound resistors, the resistance increases with temperature and returns to its original value when the temperature drops to normal. So-called composition or carbon resistors have less reliable temperature/resistance characteristics. They usually have a positive temperature coefficient, but the retrace curve as the resistor is cooled is often erratic, and in

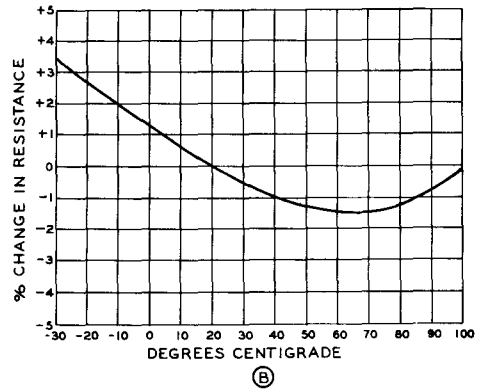
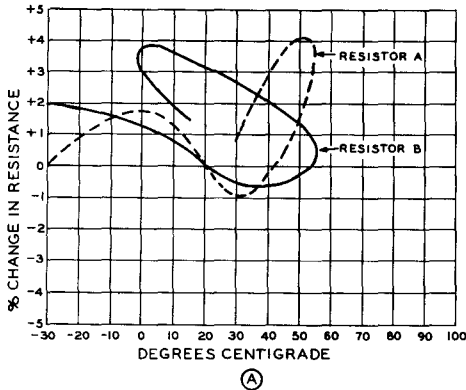

Figure 1

HEAT CYCLE OF UNCONDITIONED COMPOSITION RESISTORS

HEAT CYCLE OF CONDITIONED COMPOSITION RESISTORS

many cases the resistance does not return to its original value after a heat cycle. It is for this reason that care must be taken when soldering composition resistors in circuits that require close control of the resistance value. Matched resistors used in phase-inverter service can be heated out of tolerance by the act of soldering them into the circuit. Long leads should be left on the resistors and a long-nose pliers should grip the lead between the iron and the body of the resistor to act as a heat block. General temperature characteristics of typical carbon resistors are shown in figure 1. The behavior of an individual re-

sistor will vary from these curves depending upon the manufacturer, the size and wattage of the resistor, etc.

Inductance of Resistors Every resistor because of its physical size has in addition to its desired resistance, less desirable amounts of inductance and distributed capacitance. These quantities are illustrated in figure 2A, the general equivalent circuit of a resistor. This circuit represents the actual impedance network of a resistor at any frequency. At a certain specified frequency

Figure 2

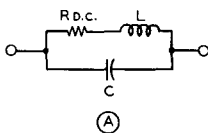

EQUIVALENT CIRCUIT OF A RESISTOR

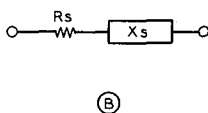

EQUIVALENT CIRCUIT OF A RESISTOR AT A PARTICULAR FREQUENCY

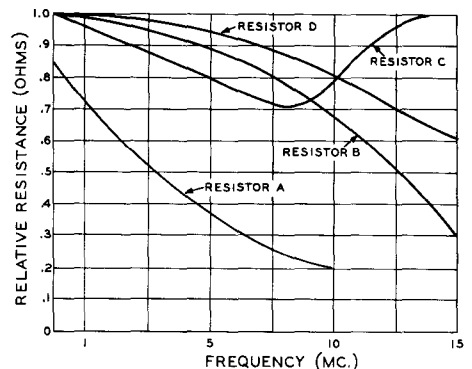

Figure 3
FREQUENCY EFFECTS ON SAMPLE
COMPOSITION RESISTORS

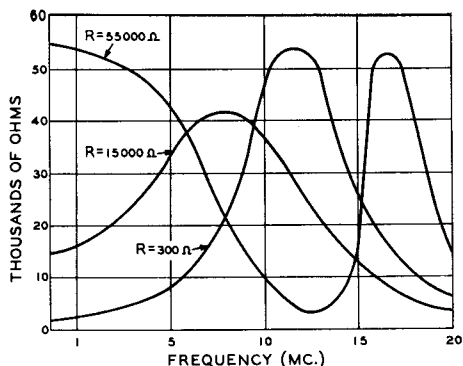

Figure 4

CURVES OF THE IMPEDANCE OF WIRE-WOUND RESISTORS AT RADIO FREQUENCIES

the impedance of the resistor may be thought of as a series reactance (X_s) as shown in figure 2B. This reactance may be either inductive or capacitive depending upon whether the residual inductance or the distributed capacitance of the resistor is the dominating factor. As a rule, skin effect tends to increase the reactance with frequency, while the capacity between turns of a wire-wound resistor, or capacity between the granules of a composition resistor tends to cause the reactance and resistance to drop with frequency. The behavior of various types of composition resistors over a large frequency range is shown in figure 3. By proper component design, non-inductive resistors having a minimum of residual reactance characteristics may be constructed. Even these have reactive effects that cannot be ignored at high frequencies.

Wirewound resistors act as low-Q inductors at radio frequencies. Figure 4 shows typical curves of the high frequency characteristics of cylindrical wirewound resistors. In addition to resistance variations wirewound resistors exhibit both capacitive and inductive reactance, depending upon the type of resistor and the operating frequency. In fact, such resistors perform in a fashion as low-Q r-f chokes below their parallel self-resonant frequency.

18-2

Capacitors

The inherent residual characteristics of capacitors include series resistance, series inductance and shunt resistance, as shown in figure 5. The series resistance and inductance

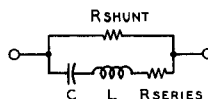

Figure 5
EQUIVALENT CIRCUIT OF A CAPACITOR

depend to a large extent upon the physical configuration of the capacitor and upon the material of which it is made. Of great interest to the amateur constructor is the series inductance of the capacitor. At a certain frequency the series inductive reactance of the capacitor and the capacitive reactance are equal and opposite, and the capacitor is in itself series resonant at this frequency. As the operating frequency of the circuit in which the capacitor is used is increased above the series resonant frequency, the effectiveness of the capacitor as a by-passing element deteriorates until the unit is about as effective as a block of wood.

By-Pass Capacitors The usual forms of by-pass capacitors have dielectrics of paper, mica, or ceramic. For audio work, and low frequency r-f work up to perhaps 2 Mc. or so, the paper capacitors are satisfactory as their relatively high internal inductance has little effect upon the proper operation of the circuit. The actual amount of internal inductance will vary widely with the manufacturing process, and some types of paper capacitors have satisfactory characteristics up to a frequency of 5 Mc. or so.

When considering the design of transmitting equipment, it must be remembered that while the transmitter is operating at some relatively low frequency of, say, 7 Mc., there will be harmonic currents flowing through the various by-pass capacitors of the order of 10 to 20 times the operating frequency. A capacitor that behaves properly at 7 Mc. however, may offer considerable impedance to the flow of these harmonic currents. For minimum harmonic generation and radiation, it is obviously of greatest importance to employ by-pass capacitors having the lowest possible internal inductance.

Mica dielectric capacitors have much less internal inductance than do most paper condensers. Figure 6 lists self-resonant frequencies of various mica capacitors having various lead lengths. It can be seen from inspection of this table that most mica capacitors become self-resonant in the 12-Mc. to 50-Mc. region. The inductive reactance they would offer to harmonic currents of 100 Mc. or so

CONDENSER	LEAD LENGTHS	RESONANT FREQ.
.02 JF MICA	NONE	44.5 MC.
.002 JF MICA	NONE	23.5 MC.
.01 JF MICA	$\frac{1}{4}$ "	10 MC.
.0009 JF MICA	$\frac{1}{4}$ "	55 MC.
.002 JF CERAMIC	$\frac{3}{8}$ "	24 MC.
.001 JF CERAMIC	$\frac{1}{4}$ "	55 MC.
500 JMF BUTTON	NONE	220 MC.
.001 JF CERAMIC	$\frac{1}{4}$ "	90 MC.
.01 JF CERAMIC	$\frac{1}{2}$ "	14.5 MC.

Figure 6
**SELF-RESONANT FREQUENCIES OF
 VARIOUS CAPACITORS WITH
 RANDOM LEAD LENGTH**

would be of considerable magnitude. In certain instances it is possible to deliberately series-resonate a mica capacitor to a certain frequency somewhat below its normal self-resonant frequency by trimming the leads to a critical length. This is sometimes done for maximum by-passing effect in the region of 40 Mc. to 60 Mc.

The recently developed button-mica capacitors shown in figure 7 are especially designed to have extremely low internal inductance. Certain types of button-mica capacitors of small physical size have a self-resonant frequency in the region of 600 Mc.

Ceramic dielectric capacitors in general have the lowest amount of series inductance per unit of capacitance of these three universally used types of by-pass capacitors. Typical resonant frequencies of various ceramic units are listed in figure 6. Ceramic capacitors are available in various voltage and capacity ratings and different physical configurations. Stand-off types such as shown in figure 7 are useful for by-passing socket and transformer terminals. Two of these capacitors may be mounted in close proximity on a chassis and connected together by an r-f choke to form a highly effective r-f filter. The inexpensive "clamshell" type of ceramic capacitor is recommended for general by-passing in r-f circuitry, as it is effective as a by-pass unit to well over 100 Mc.

The large TV "doorknob" capacitors are useful as by-pass units for high voltage lines. These capacitors have a value of 500 micro-microfarads, and are available in voltage ratings up to 40,000 volts. The dielectric of these capacitors is usually titanium-dioxide. This material exhibits piezo-electric effects, and capacitors employing it for a dielectric will tend to "talk-back" when a-c voltages are applied across them. When these capaci-

tors are used as plate bypass units in a modulated transmitter they will cause acoustical noise. Otherwise they are excellent for general r-f work.

A recent addition to the varied line of capacitors is the coaxial or "Hypass" type of capacitor. These capacitors exhibit superior by-passing qualities at frequencies up to 200 Mc. and the bulkhead type are especially effective when used to filter leads passing through partition walls between two stages.

Variable Air Capacitors Even though air is the perfect dielectric, air capacitors exhibit losses because of the inherent resistance of the metallic parts that make up the capacitor. In addition, the leakage loss across the insulating supports may become of some consequence at high frequencies. Of greater concern is the inductance of the capacitor at high frequencies. Since the capacitor must be of finite size, it will have tie-rods and metallic braces and end plates, all of which contribute to the inductance of the unit. The actual amount of the inductance will depend upon the physical size of the capacitor and the method used to make contact to the stator and rotor plates. This inductance may be cut to a minimum value by using as small a capacitor as is practical, by using insulated tie-rods to prevent the formation of closed inductive loops in the frame of the unit, and by making connections to the centers of the plate assemblies rather than to the ends as is com-

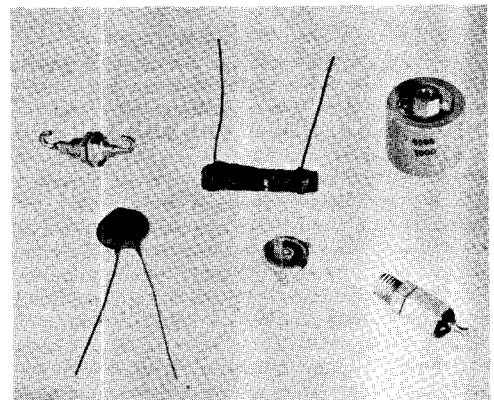

Figure 7
TYPES OF CERAMIC AND MICA CAPACITORS SUITABLE FOR HIGH-FREQUENCY BYPASSING

The Centralab 858S (1000 $\mu\mu\text{fd}$) is recommended for screen and plate circuits of tetrode tubes.

monly done. A large transmitting capacitor may have an inherent inductance as large as 0.1 microhenry, making the capacitor susceptible to parasitic resonances in the 50 Mc. to 150 Mc. range of frequencies.

The question of optimum C/L ratio and capacitor plate spacing is covered in Chapter Thirteen. For all-band operation of a high power stage, it is recommended that a capacitor just large enough for 40-meter phone operation be chosen. (This will have sufficient capacitance for phone operation on all higher frequency bands.) Then use fixed padding capacitors for operation on 80 meters. Such padding capacitors are available in air, ceramic, and vacuum types.

Specialty designed variable capacitors are recommended for u-h-f work; ordinary capacitors often have "loops" in the metal frame which may resonate near the operating frequency.

Variable Vacuum Capacitors Variable vacuum capacitors because of their small physical size have less inherent inductance per unit of capacity than do variable air capacitors. Their losses are extremely low, and their dielectric strength is high. Because of increased production the cost of such units is now within the reach of the designer of amateur equipment, and their use is highly recommended in high power tank circuits.

18-3 Wire and Inductors

Any length of wire, no matter how short, has a certain value of inductance. This property is of great help in making coils and inductors, but may be of great hindrance when it is not taken into account in circuit design and construction. Connecting circuit elements (themselves having residual inductance) together with a conductor possessing additional inductance can often lead to puzzling difficulties. A piece of no. 10 copper wire ten inches long (a not uncommon length for a plate lead in a transmitter) can have a self-inductance of 0.15 microhenries. This inductance and that of the plate tuning capacitor together with the plate-to-ground capacity of the vacuum tube can form a resonant circuit which may lead to parasitic oscillations in the v-h-f regions. To keep the self-inductance at a minimum, all r-f carrying leads should be as short as possible and should be made out of as heavy material as possible.

At the higher frequencies, solid enamelled copper wire is most efficient for r-f leads.

Tinned or stranded wire will show greater losses at these frequencies. Tank coil and tank capacitor leads should be of heavier wire than other r-f leads.

The best type of flexible lead from the envelope of a tube to a terminal is thin copper strip, cut from thin sheet copper. Heavy, rigid leads to these terminals may crack the envelope glass when a tube heats or cools.

Wires carrying only a.f. or d.c. should be chosen with the voltage and current in mind. Some of the low-filament-voltage transmitting tubes draw heavy current, and heavy wire must be used to avoid voltage drop. The voltage is low, and hence not much insulation is required. Filament and heater leads are usually twisted together. An initial check should be made on the filament voltage of all tubes of 25 watts or more plate dissipation rating. This voltage should be measured right at the tube sockets. If it is low, the filament transformer voltage should be raised. If this is impossible, heavier or parallel wires should be used for filament leads, cutting down their length if possible.

Coaxial cable may be used for high voltage leads when it is desirable to shield them from r-f fields. RG-8/U cable may be used at d-c potentials up to 8000 volts, and the lighter RG-17/U may be used to potentials of 3000 volts. Spark-plug type high-tension wire may be used for unshielded leads, and will withstand 10,000 volts.

If this cable is used, the high-voltage leads may be cabled with filament and other low-voltage leads. For high-voltage leads in low-power exciters, where the plate voltage is not over 450 volts, ordinary radio hookup wire of good quality will serve the purpose.

No r-f leads should be cabled; in fact it is better to use enamelled or bare copper wire for r-f leads and rely upon spacing for insulation. All r-f joints should be soldered, and the joint should be a good mechanical junction before solder is applied.

The efficiency and Q of air coils commonly used in amateur equipment is a factor of the shape of the coil, the proximity of the coil to other objects (including the coil form) and the material of which the coil is made. Dielectric losses in so-called "air wound" coils are low and the Q of such coils runs in the neighborhood of 300 to 500 at medium frequencies. Unfortunately, most of the transmitting type plug-in coils on the market designed for link coupling have far too small a pick up link for proper operation at 7 Mc. and 3.5 Mc. The coefficient of coupling of these coils is about 0.5, and additional means must be employed to provide satisfactory coupling at these low frequencies. Additional inductance in series with the pick up link, the whole being reso-

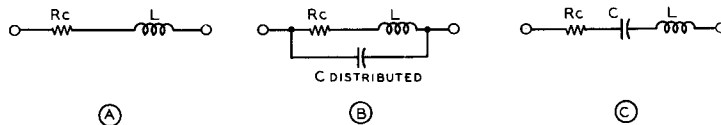

Figure 8

ELECTRICAL EQUIVALENT OF R-F CHOKE AT VARIOUS FREQUENCIES

nated to the operating frequency will often permit satisfactory coupling.

Coil Placement For best Q a coil should be in the form of a solenoid with length from one to two times the diameter. For minimum interstage coupling, coils should be made as small physically as is practicable. The coils should then be placed so that adjoining coils are oriented for minimum mutual coupling. To determine if this condition exists, apply the following test: the axis of one of the two coils must lie in the plane formed by the center turn of the other coil. If this condition is not met, there will be appreciable coupling unless the unshielded coils are very small in diameter or are spaced a considerable distance from each other.

Insulation On frequencies above 7 Mc., ceramic, polystyrene, or Mycalex insulation is to be recommended. Cold flow must be considered when using polystyrene (Amphenol 912, etc.). Bakelite has low losses on the lower frequencies but should never be used in the field of high-frequency tank circuits.

Lucite (or Plexiglas), which is available in rods, sheets, or tubing, is satisfactory for use at all radio frequencies where the r-f voltages are not especially high. It is very easy to work with ordinary tools and is not expensive. The loss factor depends to a considerable extent upon the amount and kind of plasticizer used.

The most important thing to keep in mind regarding insulation is that the best insulation is air. If it is necessary to reinforce air-wound coils to keep turns from vibrating or touching, use strips of Lucite or polystyrene cemented in place with Amphenol 912 coil dope. This will result in lower losses than the commonly used celluloid ribs and Duco cement.

Radio Frequency Chokes R-f chokes may be considered to be special inductances designed to have a

high value of impedance over a large range of frequencies. A practical r-f choke has inductance, distributed capacitance, and resistance.

At low frequencies, the distributed capacity has little effect and the electrical equivalent circuit of the r-f choke is as shown in figure 8A. As the operating frequency of the choke is raised the effect of the distributed capacity becomes more evident until at some particular frequency the distributed capacity resonates with the inductance of the choke and a parallel resonant circuit is formed. This point is shown in figure 8B. As the frequency of operation is further increased the overall reactance of the choke becomes capacitive, and finally a point of series resonance is reached (figure 8C.). This cycle repeats itself as the operating frequency is raised above the series resonant point, the impedance of the choke rapidly becoming lower on each successive cycle. A chart of this action is shown in figure 9. It can be seen that as the r-f choke approaches and leaves a condition of series resonance, the performance of the choke is seriously impaired. The condition of series resonance may easily be found by shorting the terminals of the r-f choke in question with a piece of wire and exploring the windings of the choke with a grid-dip oscillator. Most commercial transmitting type chokes have series resonances in the vicinity of 11 Mc. or 24 Mc.

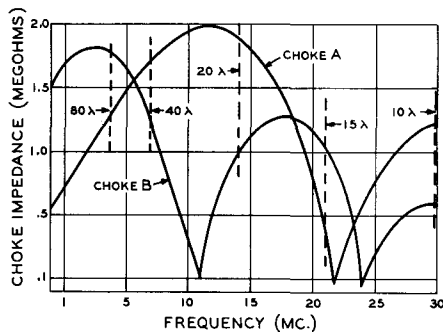

Figure 9

FREQUENCY-IMPEDANCE CHARACTERISTICS FOR TYPICAL PIE-WOUND R-F CHOKES

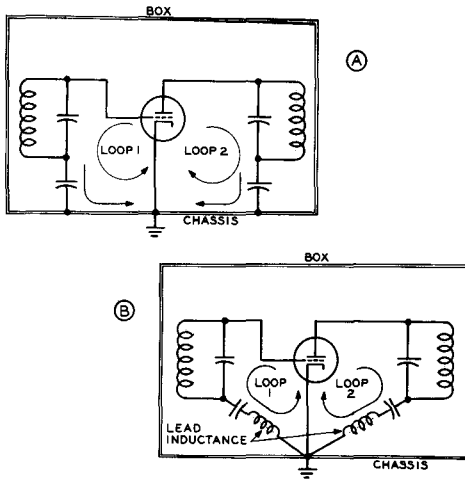

Figure 10

GROUND LOOPS IN AMPLIFIER STAGES

- A. Using chassis return
B. Common ground point

construction the physical size of the components prevent such close grouping. It is necessary to spread the components of such a stage over a fairly large area. In this case it is best to ground items directly to the chassis at the nearest possible point, with short, direct grounding leads. The ground currents will flow from these points through the low inductance chassis to the cathode return of the stage. Components grounded on the top of the chassis have their ground currents flow through holes to the cathode circuit which is usually located on the bottom of the chassis, since such currents travel on the surface of the chassis. The usual "top to bottom" ground path is through the hole cut in the chassis for the tube socket. When the gain per stage is relatively low, or there are only a small number of stages on a chassis this universal grounding system is ideal. It is only in high gain stages (i-f strips) where the "gain per inch" is very high that circulating ground currents will cause operational instability.

Intercoupling of Ground Currents It is important to prevent intercoupling of various different ground currents when the chassis is used as a common ground return. To keep this intercoupling at a minimum, the stage should be completely shielded. This will prevent external fields from generating spurious ground currents, and prevent the ground currents of the stage from upsetting the action of nearby stages. Since the ground currents travel on the surface of the metal, the stage should be enclosed in an electrically tight box. When this is done, all ground currents generated inside the box will remain in the box. The only possible means of escape for fundamental and harmonic currents are imperfections in this electrically tight box. Whenever we bring a wire lead into the box, make a ventilation hole, or bring a control shaft through the box we create an imperfection. It is important that the effect of these imperfections be reduced to a minimum.

18-4

Grounds

At frequencies of 30 Mc. and below, a chassis may be considered as a fixed ground reference, since its dimensions are only a fraction of a wavelength. As the frequency is increased above 30 Mc., the chassis must be considered as a conducting sheet on which there are points of maximum current and potential. However, for the lower amateur frequencies, an object may be assumed to be at ground potential when it is affixed to the chassis.

In transmitter stages, two important current loops exist. One loop consists of the grid circuit and chassis return, and the other loop consists of the plate circuit and chassis return. These two loops are shown in figure 10A. It can be seen that the chassis forms a return for both the grid and plate circuits, and that ground currents flow in the chassis towards the cathode circuit of the stage. For some years the theory has been to separate these ground currents from the chassis by returning all ground leads to one point, usually the cathode of the tube for the stage in question. This is well and good if the ground leads are of minute length and do not introduce cross couplings between the leads. Such a technique is illustrated in figure 10B. wherein all stage components are grounded to the cathode pin of the stage socket. However, in transmitter

18-5 Holes, Leads and Shafts

Large size holes for ventilation may be put in an electrically tight box provided they are properly screened. Perforated metal stock having many small, closely spaced holes is the best screening material. Copper wire screen may be used provided the screen wires are bonded together every few inches. As the wire corrodes, an insulating film prevents contact between the individual wires, and the attenuation of the screening suffers. The screening material should be carefully soldered to the

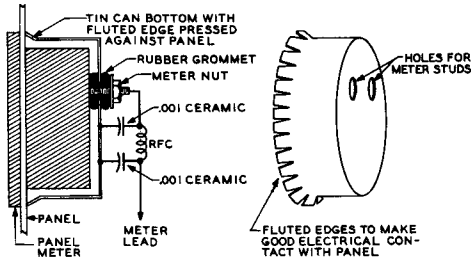

Figure 11A
SIMPLE METER SHIELD

box, or bolted with a spacing of not less than two inches between bolts. Mating surfaces of the box and the screening should be clean.

A screened ventilation opening should be roughly three times the size of an equivalent unshielded opening, since the screening represents about a 70 per cent coverage of the area. Careful attention must be paid to equipment heating when an electrically tight box is used.

Commercially available panels having half-inch ventilating holes may be used as part of the box. These holes have much less attenuation than does screening, but will perform in a satisfactory manner in all but the areas of weakest TV reception. If it is desired to reduce leakage from these panels to a minimum, the back of the grille must be covered with screening tightly bonded to the panel.

Doors may be placed in electrically tight boxes provided there is no r-f leakage around the seams of the door. Electronic weather-stripping or metal "finger stock" may be used to seal these doors. A long, narrow slot in a closed box has the tendency to act as a slot antenna and harmonic energy may pass more readily through such an opening than it would through a much larger circular hole.

Variable capacitor shafts or switch shafts may act as antennas, picking up currents inside the box and re-radiating them outside of the box. It is necessary either to ground the shaft securely as it leaves the box, or else to make the shaft of some insulating material.

A two or three inch panel meter requires a large leakage hole if it is mounted in the wall of an electrically tight box. To minimize leakage, the meter leads should be by-passed and shielded. The meter should be encased with a metal shield that makes contact to the box entirely around the meter. The connecting studs of the meter may project through the back of the metal shield. Such a shield may be made out of the end of a tin can of correct

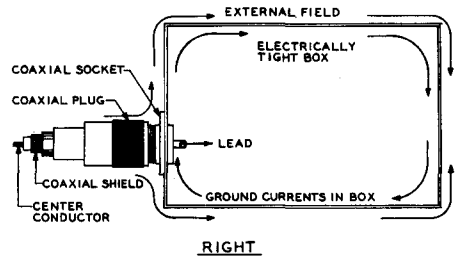

RIGHT

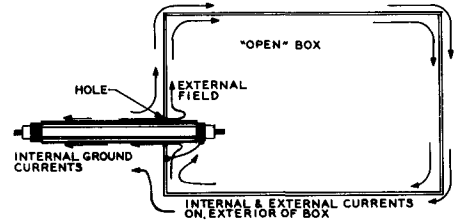

WRONG

Figure 11B

Use of coaxial connectors on electrically tight box prevents escape of ground currents from interior of box. At the same time external fields are not conducted into the interior of the box.

diameter, cut to fit the depth of the meter. This complete shield assembly is shown in figure 11A.

Careful attention should be paid to leads entering and leaving the electrically tight box. Harmonic currents generated within the box can easily flow out of the box on power or control leads, or even on the outer shields of coaxially shielded wires. Figure 11B illustrates the correct method of bringing shielded cables into a box where it is desired to preserve the continuity of the shielding.

Unshielded leads entering the box must be carefully filtered to prevent fundamental and harmonic energy from escaping down the lead. Combinations of r-f chokes and low inductance by-pass capacitors should be used in power leads. If the current in the lead is high, the chokes must be wound of large gauge wire. Composition resistors may be substituted for the r-f chokes in high impedance circuits. Bulkhead or feed-through type capacitors are preferable when passing a lead through a shield partition. A summary of lead leakage with various filter arrangements is shown in figure 12.

Internal Leads Leads that connect two points within an electrically tight box

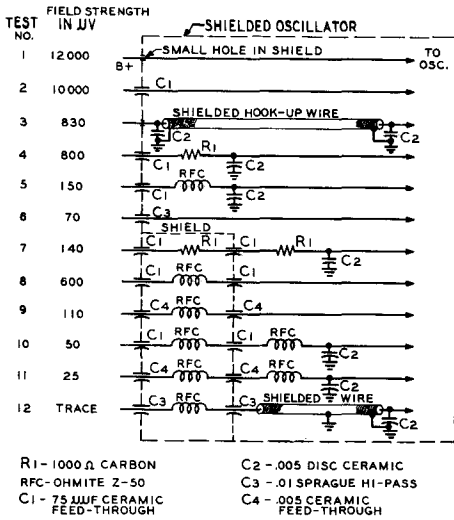

Figure 12
LEAD LEAKAGE WITH VARIOUS
LEAD FILTERING SYSTEMS
(COURTESY WIDBM)

was operated near this frequency marked instability was noted, and the filaments of the 810 tubes increased in brilliance when plate voltage was applied to the amplifier, indicating the presence of r.f. in the filament circuit. Changing the filament by-pass capacitors to .01- μ f. lowered the filament resonance frequency to 2.2 Mc. and cured this effect. A ceramic capacitor of .01- μ f. used as a filament by-pass capacitor on each filament leg seems to be satisfactory from both a resonant and a TVI point of view. Filament by-pass capacitors smaller in value than .01- μ f. should be used with caution.

Various parasitic resonances are also found in plate and grid tank circuits. Push-pull tank circuits are prone to double resonances, as shown in figure 14. The parasitic resonance circuit is usually several megacycles higher than the actual resonant frequency of the full tank circuit. The cure for such a double resonance is the inclusion of an r-f choke in the center tap lead to the split coil.

Chassis Material From a point of view of electrical properties, aluminum is a poor chassis material. It is difficult to make a soldered joint to it, and all grounds must rely upon a pressure joint. These pres-

may pick up fundamental and harmonic currents if they are located in a strong field of flux. Any lead forming a closed loop with itself will pick up such currents, as shown in figure 13. This effect is enhanced if the lead happens to be self-resonant at the frequency at which the exciting energy is supplied. The solution for all of this is to by-pass all internal power leads and control leads at each end, and to shield these leads their entire length. All filament, bias, and meter leads should be so treated. This will make the job of filtering the leads as they leave the box much easier, since normally "cool" leads within the box will not have picked up spurious currents from nearby "hot" leads.

18-6 Parasitic Resonances

Filament leads within vacuum tubes may resonate with the filament by-pass capacitors at some particular frequency and cause instability in an amplifier stage. Large tubes of the 810 and 250TH type are prone to this spurious effect. In particular, a push-pull 810 amplifier using .001- μ f. filament by-pass capacitors had a filament resonant loop that fell in the 7-Mc. amateur band. When the amplifier

Figure 13

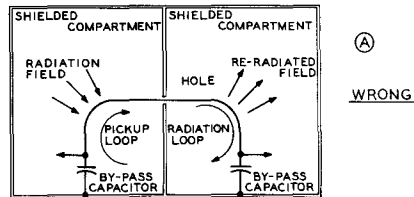

ILLUSTRATION OF HOW A SUPPOSEDLY
GROUNDED POWER LEAD CAN COUPLE
ENERGY FROM ONE COMPARTMENT
TO ANOTHER

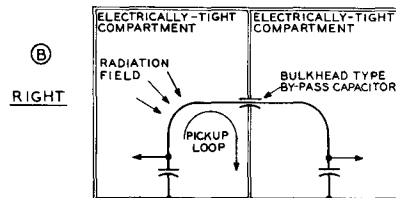

ILLUSTRATION OF LEAD ISOLATION BY
PROPER USE OF BULKHEAD
CAPACITOR

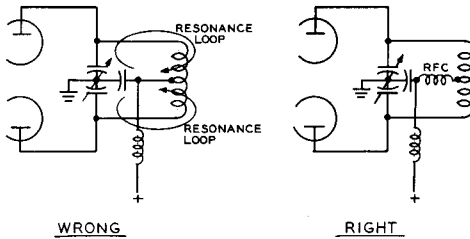

Figure 14
DOUBLE RESONANCE EFFECTS IN PUSH-PULL TANK CIRCUIT MAY BE ELIMINATED BY THE INSERTION OF ANY R-F CHOKE IN THE COIL CENTER TAP LEAD

sure joints are prone to give trouble at a later date because of high resistivity caused by the formation of oxides from electrolytic action in the joint. However, the ease of working and forming the aluminum material far outweighs the electrical shortcomings, and aluminum chassis and shielding may be used with good results provided care is taken in making all grounding connections. Cadmium and zinc plated chassis are preferable from a corrosion standpoint, but are much more difficult to handle in the home workshop.

18-7 Parasitic Oscillation in R-F Amplifiers

Parasitics (as distinguished from *self-oscillation* on the normal tuned frequency of the amplifier) are undesirable oscillations either of very high or very low frequencies which may occur in radio-frequency amplifiers.

They may cause spurious signals (which are often rough in tone) other than normal harmonics, hash on each side of a modulated carrier, key clicks, voltage breakdown or flash-over, instability or inefficiency, and shortened life or failure of the tubes. They may be damped and stop by themselves after keying or modulation peaks, or they may be undamped and build up during ordinary unmodulated transmission, continuing if the excitation is removed. They may result from series or parallel resonant circuits of all types. Due to neutralizing lead length and the nature of most parasitic circuits, the amplifier usually is not neutralized for the parasitic frequency.

Sometimes the fact that the plate supply is keyed will obscure parasitic oscillations in a

final amplifier stage that might be very severe if the plate voltage were left on and the excitation were keyed.

In some cases, an all-wave receiver will prove helpful in locating v-h-f spurious oscillations, but it may be necessary to check from several hundred megacycles downward in frequency to the operating range. A normal harmonic is weaker than the fundamental but of good tone; a strong harmonic or a rough note at any frequency generally indicates a parasitic.

In general, the cure for parasitic oscillation is two-fold: The oscillatory circuit is damped until sustained oscillation is impossible, or it is detuned until oscillation ceases. An examination of the various types of parasitic oscillations and of the parasitic oscillatory circuits will prove handy in applying the correct cure.

Low Frequency Parasitic Oscillations One type of unwanted oscillation often occurs in shunt-fed circuits in which the grid and plate chokes resonate, coupled through the tube's interelectrode capacitance. This also can happen with series feed. This oscillation is generally at a much lower frequency than the operating frequency and will cause additional carriers to appear, spaced from perhaps twenty to a few hundred kilocycles on either side of the main wave. Such a circuit is illustrated in figure 15. In this case, RFC_1 and RFC_2 form the grid and plate inductances of the parasitic oscillator. The neutralizing capacitor, no longer providing out-of-phase feedback to the grid circuit actually enhances the low frequency oscillation. Because of the low Q of the r-f chokes, they will usually run warm when this type of parasitic oscillation is present and may actually char and burn up. A neon bulb held near the oscillatory circuit will glow a bright yellow, the color appearing near the glass of the neon bulb and not between the electrodes.

One cure for this type of oscillation is to change the type of choke in either the plate or the grid circuit. This is a marginal cure, because the amplifier may again break into the same type of oscillation when the plate voltage is raised slightly. The best cure is to remove the grid r-f choke entirely and replace it with a wire-wound resistor of sufficient wattage to carry the amplifier grid current. If the inclusion of such a resistor upsets the operating bias of the stage, an r-f choke may be used, with a 100-ohm 2-watt carbon resistor in series with the choke to lower the operating Q of the choke. If this expedient does not eliminate the condition, and the stage under investigation uses a beam-tetrode tube, negative resistance can exist in the screen circuit

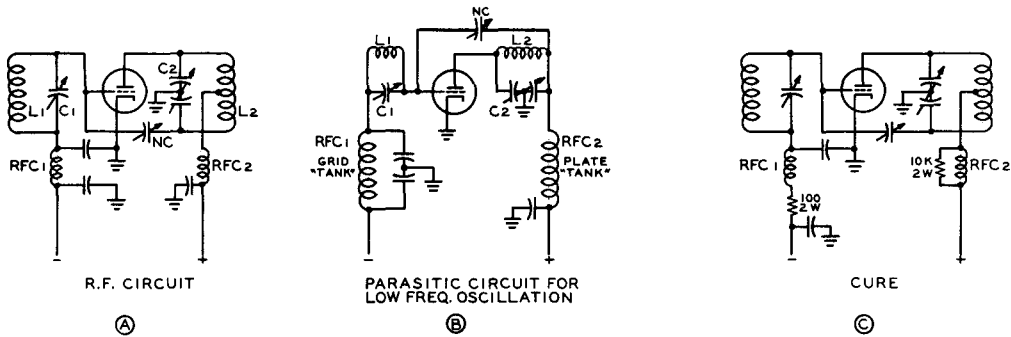

Figure 15

THE CAUSE AND CURE OF LOW FREQUENCY PARASITICS

of such tubes. Try larger and smaller screen by-pass capacitors to determine whether or not they have any effect. If the condition is coming from the screen circuit an audio choke with a resistor across it in series with the screen feed lead will often eliminate the trouble.

Low-frequency parasitic oscillations can often take place in the audio system of an AM transmitter, and their presence will not be known until the transmitter is checked on a receiver. It is easy to determine whether or not the oscillations are coming from the modulator simply by switching off the modulator tubes. If the oscillations are coming from the modulator, the stage in which they are being generated can be determined by removing tubes successively, starting with the first speech amplification stage, until the oscillation stops. When the stage has been found, remedial steps can be taken on that stage.

If the stage causing the oscillation is a low-level speech stage it is possible that the trouble is coming from r-f or power-supply feedback, or it may be coming about as a result of inductive coupling between two transformers. If the oscillation is taking place in a high-level audio stage, it is possible that inductive or capacitive coupling is taking place back to one of the low-level speech stages. It is also possible, in certain cases, that parasitic push-pull oscillation can take place in a Class B or Class AB modulator as a result of the grid-to-plate capacitance within the tubes and in the stage wiring. This condition is more likely to occur if capacitors have been placed across the secondary of the driver transformer and across the primary of the modulation transformer to act in the reduction of the amplitude of the higher audio frequencies. Relocation of wiring or actual neutralization of the audio stage in the manner used for r-f stages may be required.

It may be said in general that the presence of low-frequency parasitics indicates that somewhere in the oscillating circuit there is an impedance which is high at a frequency in the upper audio or low r-f range. This impedance may include one or more r-f chokes of the conventional variety, power supply chokes, modulation components, or the high impedance may be presented simply by an RC circuit such as might be found in the screen-feed circuit of a beam-tetrode amplifier stage.

18-8 Elimination of V-H-F Parasitic Oscillations

V-h-f parasitic oscillations are often difficult to locate and difficult to eliminate since their frequency often is only moderately above the desired frequency of operation. But it may be said that v-h-f parasitics always may be eliminated if the operating frequency is appreciably below the upper frequency limit for the tubes used in the stage. However, the elimination of a persistent parasitic oscillation on a frequency only moderately higher than the desired operating frequency will involve a sacrifice in either the power output or the power sensitivity of the stage, or in both.

Beam-tetrode stages, particularly those using 807 type tubes, will almost invariably have one or more v-h-f parasitic oscillations unless adequate precautions have been taken in advance. Many of the units described in the constructional section of this edition had parasitic oscillations when first constructed. But these oscillations were eliminated in each case; hence, the expedients used in these equipments should be studied. V-h-f parasitics may be readily identified, as they cause a

neon lamp to have a purple glow close to the electrodes when it is excited by the parasitic energy.

Parasitic Oscillations with Triodes

Triode stages are less subject to parasitic oscillations primarily because of the much lower power sensitivity of such tubes as compared to beam tetrodes. But such oscillations can and do take place. Usually, however, it is not necessary to incorporate lossier resistors as normally is the case with beam tetrodes, unless the triodes are operated quite near to their upper frequency limit, or the tubes are characterized by a relatively high transconductance. Triode v-h-f parasitic oscillations normally may be eliminated by adjustment of the lengths and effective inductance of the leads to the elements of the tubes.

In the case of triodes, v-h-f parasitic oscillations often come about as a result of inductance in the neutralizing leads. This is particularly true in the case of push-pull amplifiers. The cure for this effect will usually be found in reducing the length of the neutralizing leads and increasing their diameter. Both the reduction in length and increase in diameter will reduce the inductance of the leads and tend to raise the parasitic oscillation frequency until it is out of the range at which the tubes will oscillate. The use of straightforward circuit design with short leads will assist in forestalling this trouble at the outset. Butterfly-type tank capacitors with the neutralizing capacitors built into the unit (such as the B&W type) are effective in this regard.

V-h-f parasitic oscillations may take place as a result of inadequate by-passing or long by-pass leads in the filament, grid-return and plate-return circuits. Such oscillations also can take place when long leads exist between the grids and the grid tuning capacitor or between the plates and the plate tuning capacitor. The grid and plate leads should be kept short, but the leads from the tuning capacitors to the tank coils can be of any reasonable length insofar as parasitic oscillations are concerned. In an amplifier where oscillations have been traced to the grid or plate leads, their elimination can often be effected by making the grid leads much longer than the plate leads or vice versa. Sometimes parasitic oscillations can be eliminated by using iron or nichrome wire for the grid or plate leads, or for the neutralizing leads. But in any event it will always be found best to make the neutralizing leads as short and of as heavy conductor as is practicable.

In cases where it has been found that increased length in the grid leads for an amplifier is required, this increased length can often be wound into the form of a small coil and still

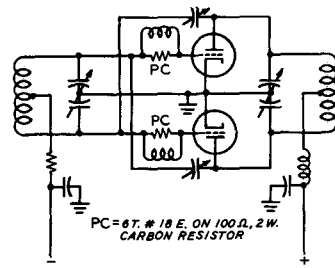

Figure 16
GRID PARASITIC SUPPRESSORS IN PUSH-PULL TRIODE STAGE

obtain the desired effect. Winding these small coils of iron or nichrome wire may sometimes be of assistance.

To increase losses at the parasitic frequency, the parasitic coils may be wound on 100-ohm 2-watt resistors. These "lossy" suppressors should be placed in the grid leads of the tubes close to the grid connection, as shown in figure 16.

Parasitics with Beam Tetrodes Where beam-tetrode tubes are used in the stage which has been found to be generating the parasitic oscillation, all the foregoing suggestions apply in general. However, there are certain additional considerations involved in elimination of parasitics from beam-tetrode amplifier stages. These considerations involve the facts that a beam-tetrode amplifier stage has greater power sensitivity than an equivalent triode amplifier, such a stage has a certain amount of screen-lead inductance which may give rise to trouble, and such stages have a small amount of feedback capacitance.

Beam-tetrode stages often will require the inclusion of a neutralizing circuit to eliminate oscillation on the operating frequency. However, oscillation on the operating frequency normally is not called a parasitic oscillation, and different measures are required to eliminate the condition.

Basically, parasitic oscillations in beam-tetrode amplifier stages fall into two classes: cathode-grid-screen oscillations, and cathode-screen-plate oscillations. Both these types of oscillation can be eliminated through the use of a parasitic suppressor in the lead between the screen terminal of the tube and the screen by-pass suppressor, as shown in figure 17. Such a suppressor has negligible effect on the by-passing effect of the screen at the operating frequency. The method of connecting this

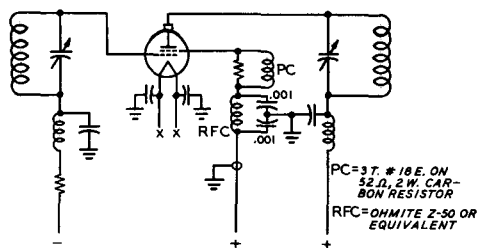

Figure 17

SCREEN PARASITIC SUPPRESSION CIRCUIT FOR TETRODE TUBES

suppressor to tubes having dual screen leads is shown in figure 18. At the higher frequencies at which parasitics occur, the screen is no longer at ground potential. It is therefore necessary to include an r-f choke by-pass condenser filter in the screen lead after the parasitic suppressor. The screen lead, in addition, should be shielded for best results.

During parasitic oscillations, considerable r-f voltage appears on the screen of a tetrode tube, and the screen by-pass condenser can easily be damaged. It is best, therefore, to employ screen by-pass condensers whose d-c working voltage is equal to twice the maximum applied screen voltage.

The grid-screen oscillations may occasionally be eliminated through the use of a parasitic suppressor in series with the grid lead of the tube. The screen plate oscillations may also be eliminated by inclusion of a parasitic suppressor in series with the plate lead of the tube. A suitable grid suppressor may be made of a 22-ohm 2-watt Ohmite or Allen-Bradley resistor wound with 8 turns of no. 18 enameled wire. A plate circuit suppressor is more of a problem, since it must dissipate a quantity of power that is dependent upon just how close the parasitic frequency is to the operating frequency of the tube. If the two frequencies are close, the suppressor will absorb some of the fundamental plate circuit power. For kilowatt stages operating no higher than 30 Mc. a satisfactory plate circuit suppressor may be made of five 570-ohm 2-watt carbon resistors in parallel, shunted by 5 turns of no. 16 enameled wire, $\frac{1}{4}$ inch diameter and $\frac{1}{2}$ inch long (figure 19A and B).

The parasitic suppressor for the plate circuit of a small tube such as the 5763, 2E26, 807, 6146 or similar type normally may consist of a 47-ohm carbon resistor of 2-watt size with 6 turns of no. 18 enameled wire wound around the resistor. However, for operation above 30 Mc., special tailoring of the value

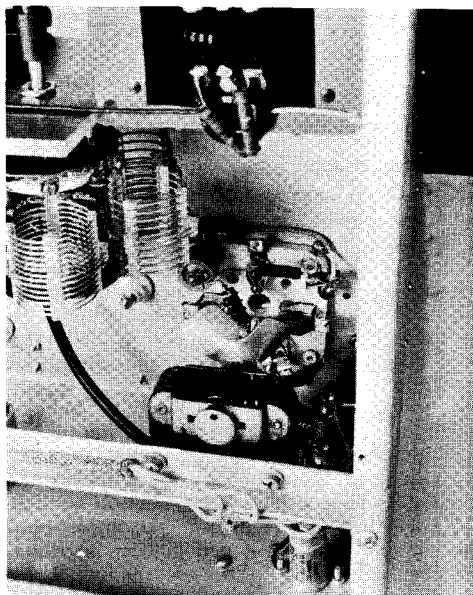

Figure 18

PHOTO OF APPLICATION OF SCREEN PARASITIC SUPPRESSION CIRCUIT OF FIGURE 17

of the resistor and the size of the coil wound around it will be required in order to attain satisfactory parasitic suppression without excessive power loss in the parasitic suppressor.

Tetrode Screening Isolation between the grid and plate circuits of a tetrode tube is not perfect. For maximum stability, it is recommended that the tetrode stage be neutralized. Neutralization is *absolutely necessary* unless the grid and plate circuits of the tetrode stage are each completely isolated from each other in electrically tight boxes. Even when this is done, the stage will show signs of regeneration when the plate and grid tank circuits are tuned to the same frequency. Neutralization will eliminate this regeneration. Any of the neutralization circuits described in the chapter *Generation of R-F Energy* may be used.

18-9 Checking for-Parasitic Oscillations

It is an unusual transmitter which harbors no parasitic oscillations when first constructed

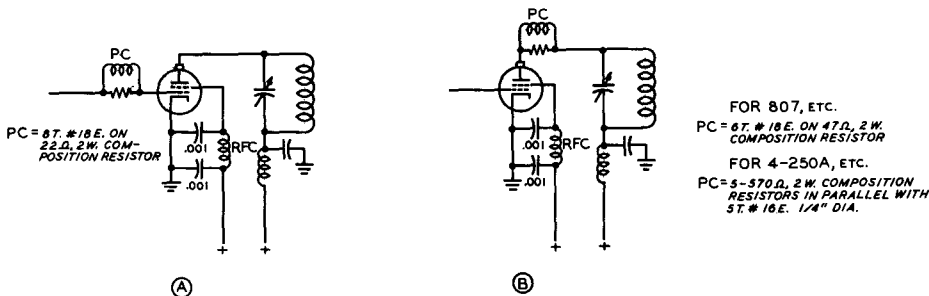

Figure 19

PLATE AND GRID PARASITIC SUPPRESSION IN TETRODE TUBES

and tested. Therefore it is always wise to follow a definite procedure in checking a new transmitter for parasitic oscillations.

Parasitic oscillations of all types are most easily found when the stage in question is running by itself, with full plate (and screen) voltage, sufficient protective bias to limit the plate current to a safe value, and no excitation. One stage should be tested at a time, and the complete transmitter should never be put on the air until all stages have been thoroughly checked for parasitics.

To protect tetrode tubes during tests for parasitics, the screen voltage should be applied through a series resistor which will limit the screen current to a safe value in case the plate voltage of the tetrode is suddenly removed when the screen supply is on. The correct procedure for parasitic testing is as follows (figure 20):

1. The stage in question should be coupled to a dummy load, and tuned up in correct operating shape. Sufficient protective bias should be applied to the tube at all times. For protection of the stage under test, a lamp bulb should be added in series with one leg of the primary circuit of the high voltage power supply. As the plate supply load increases during a period of parasitic oscillation, the voltage drop across the lamp increases, and the effective plate voltage drops. Bulbs of various size may be tried to adjust the voltage under testing conditions to the correct amount. If a Variac or Powerstat is at hand, it may be used in place of the bulbs for smoother voltage control. Don't test for parasitics unless some type of voltage control is used on the high voltage supply! When a stage breaks into parasitic oscillations, the plate current increases violently, and some protection to the tube under test *must* be used.

2. The r-f excitation to the tube should now be removed. When this is done, the grid, screen

and plate currents of the tube should drop to zero. Grid and plate tuning condensers should be tuned to minimum capacity. No change in resting grid, screen or plate current should be observed. If a parasitic is present, grid current will flow, and there will be an abrupt increase in plate current. The size of the lamp bulb in series with the high voltage supply may be varied until the stage can oscillate continuously, without exceeding the rated plate dissipation of the tube.

3. The frequency of the parasitic may now be determined by means of an absorption wave meter, or a neon bulb. Low frequency oscillations will cause a neon bulb to glow yellow. High frequency oscillations will cause the bulb to have a soft, violet glow. Once the frequency of oscillation is determined, the cures suggested in this chapter may be applied to the stage.

4. When the stage can pass the above test with no signs of parasitics, the bias supply of the tube in question should be decreased until the tube is dissipating its full plate rating when full plate voltage is applied, with no r-f

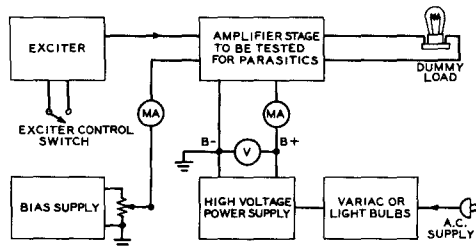

Figure 20

SUGGESTED TEST SETUP FOR PARASITIC TESTS

excitation. Excitation may now be applied and the stage loaded to full input into a dummy load. The signal should now be monitored in a nearby receiver which has the antenna terminals grounded or otherwise shorted out. A series of rapid dots should be sent, and the frequency spectrum for several megacycles each side of the carrier frequency carefully searched. If any vestige of parasitic is left, it will show up as an occasional "pop" on a keyed dot. This "pop" may be enhanced by a slight detuning of either the grid or plate circuit.

5. If such a parasitic shows up, it means that the stage is still not stable, and further measures must be applied to the circuit. Parasitic suppressors may be needed in both screen and grid leads of a tetrode, or perhaps in both grid and neutralizing leads of a triode stage.

As a last resort, a 10,000-ohm 25-watt wirewound resistor may be shunted across the grid coil, or grid tuning condenser of a high powered stage. This strategy removed a keying pop that showed up in a commercial transmitter, operating at a plate voltage of 5000.

Test for Parasitic Tendency in Tetrode Amplifiers It is common experience to develop an engineering model of a new equipment that is apparently free of parasitics and then find troublesome oscillations showing up in production units. The reason for this is that the equipment has a parasitic tendency that remains below the verge of oscillation until some change in a component, tube gain, or operating condition raises the gain of the parasitic circuit enough to start oscillation.

In most high frequency transmitters there are a great many resonances in the tank circuits at frequencies other than the desired

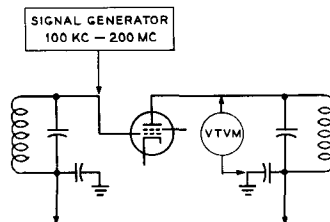

Figure 21

PARASITIC GAIN MEASUREMENT

Grid-dip oscillator and vacuum tube voltmeter may be used to measure parasitic stage gain over 100kc-200mc region.

operating frequency. Most of these parasitic resonant circuits are not coupled to the tube and have no significant tendency to oscillate. A few, however, are coupled to the tube in some form of oscillatory circuit. If the regeneration is great enough, oscillation at the parasitic frequency results. Those spurious circuits existing just below oscillation must be found and suppressed to a safe level.

One test method is to feed a signal from a grid-dip oscillator into the grid of a stage and measure the resulting signal level in the plate circuit of the stage, as shown in figure 21. The test is made with all operating voltages applied to the tubes. Class C stages should have bias reduced so a reasonable amount of static plate current flows. The grid-dip oscillator is tuned over the range of 100 kc to 200 mc, and the relative level of the r-f voltmeter is watched and the frequencies at which voltage peaks occur are noted. Each significant peak in voltage gain in the stage must be investigated. Circuit changes or suppression must then be added to reduce all peaks by 10 db or more in amplitude.

Television and Broadcast Interference

The problem of interference to television reception is best approached by the philosophy discussed in Chapter Eighteen. By correct design procedure, spurious harmonic generation in low frequency transmitters may be held to a minimum. The remaining problem is twofold: to make sure that the residual harmonics generated by the transmitter are not radiated, and to make sure that the fundamental signal of the transmitter does not overload the television receiver by reason of the proximity of one to the other.

In an area of high TV-signal field intensity the TVI problem is capable of complete solution with routine measures both at the amateur transmitter and at the affected receivers. But in fringe areas of low TV-signal field strength the complete elimination of TVI is a difficult and challenging problem. The fundamentals illustrated in Chapter Fifteen must be closely followed, and additional antenna filtering of the transmitter is required.

19-1 Types of Television Interference

There are three main types of TVI which may be caused singly or in combination by the emissions from an amateur transmitter. These types of interference are:

- (1) Overloading of the TV set by the transmitter fundamental
- (2) Impairment of the picture by spurious emissions
- (3) Impairment of the picture by the radiation of harmonics

TV Set Overloading Even if the amateur transmitter were perfect and had no harmonic radiation or spurious emissions whatever, it still would be likely to cause overloading of TV sets whose antennas were within a few hundred feet of the transmitting antenna. This type of overloading is essentially the same as the common type of BCI encountered when operating a medium-power or high-power amateur transmitter within a few hundred feet of the normal type of BCL receiver. The field intensity in the immediate vicinity of the transmitting antenna is sufficiently high that the amateur signal will get into the BC or TV set either through overloading of the front end, or through the i-f, video, or audio system. A characteristic of this type of interference is that it always will be eliminated when the transmitter temporarily is operated into a dummy antenna. Another characteristic of this type of overloading is that its effects will be substantially continuous over the entire frequency coverage of the BC or TV receiver. Channels 2 through 13 will be affected in approximately the same manner.

With the overloading type of interference the problem is simply to keep the *fundamental* of the transmitter out of the affected receiver. Other types of interference may or may not show up when the fundamental is taken out of the TV set (they probably will appear), but at least the fundamental *must* be eliminated first.

The elimination of the transmitter fundamental from the TV set is normally the only operation performed on or in the vicinity of the TV receiver. After the fundamental has been elimi-

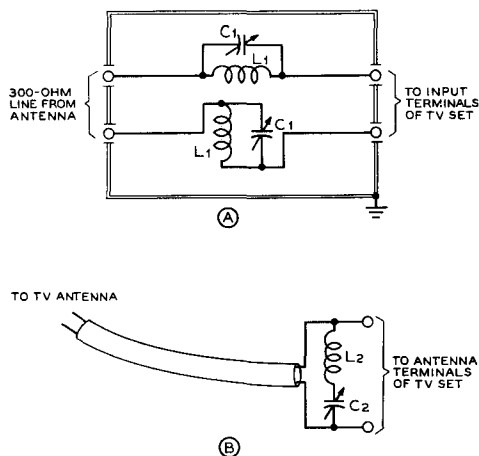

Figure 1

TUNED TRAPS FOR THE TRANSMITTER FUNDAMENTAL

The arrangement at (A) has proven to be effective in eliminating the condition of general blocking as caused by a 28-Mc. transmitter in the vicinity of a TV receiver. The tuned circuits L_1 - C_1 are resonated separately to the frequency of transmission. The adjustment may be done at the station, or it may be accomplished at the TV receiver by tuning for minimum interference on the TV screen.

Shown at (B) is an alternative arrangement with a series-tuned circuit across the antenna terminals of the TV set. The tuned circuit should be resonated to the operating frequency of the transmitter. This arrangement gives less attenuation of the interfering signal than that at (A); the circuit has proven effective with interference from transmitters on the 50-Mc. band, and with low-power 28-Mc. transmitters.

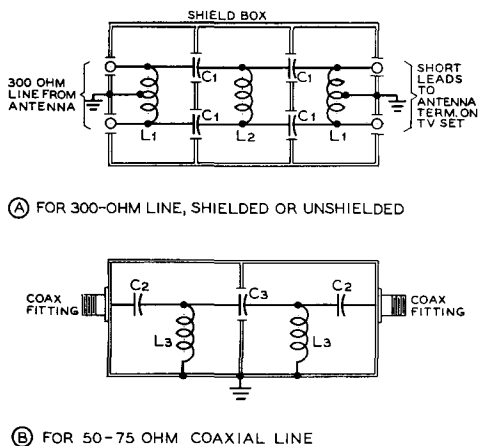

Figure 2

HIGH-PASS TRANSMISSION LINE FILTERS

The arrangement at (A) will stop the passing of all signals below about 45 Mc. from the antenna transmission line into the TV set. Coils L_1 are each 1.2 microhenrys (17 turns no. 24 enam. closewound on $\frac{1}{4}$ -inch dia. polystyrene rod) with the center tap grounded. It will be found best to scrape, twist, and solder the center tap before winding the coil. The number of turns each side of the tap may then be varied until the tap is in the exact center of the winding. Coil L_2 is 0.6 microhenry (12 turns no. 24 enam. closewound on $\frac{1}{4}$ -inch dia. polystyrene rod). The capacitors should be about $16.5 \mu\text{fd.}$, but either 15 or $20 \mu\text{fd.}$ ceramic capacitors will give satisfactory results. A similar filter for coaxial antenna transmission line is shown at (B). Both coils should be 0.12 microhenry (7 turns no. 18 enam. spaced to $\frac{1}{2}$ inch on $\frac{1}{4}$ -inch dia. polystyrene rod). Capacitors C_2 should be $75 \mu\text{fd.}$ midget ceramics, while C_3 should be a $40\text{-}\mu\text{fd.}$ ceramic.

nated as a source of interference to reception, work may then be begun on or in the vicinity of the transmitter toward eliminating the other two types of interference.

Taking Out the Fundamental More or less standard BCI-type practice is most commonly used in taking out fundamental interference. Wavetraps and filters are installed, and the antenna system may or may not be modified so as to offer less response to the signal from the amateur transmitter. In regard to a comparison between wavetraps and filters, the same considerations apply as have been effective in regard to BCI for many years; wavetraps are quite effective when properly installed and adjusted, but they

must be readjusted whenever the band of operation is changed, or even when moving from one extreme end of a band to the other. Hence, wavetraps are not recommended except when operation will be confined to a relatively narrow portion of one amateur band. However, figure 1 shows two of the most common signal trapping arrangements.

High-Pass Filters High-pass filters in the antenna lead of the TV set have proven to be quite satisfactory as a means of eliminating TVI of the overloading type. In many cases when the interfering transmitter is operated only on the bands below 7.3 Mc., the use of a high-pass filter in the antenna lead has completely eliminated all

TVI. In some cases the installation of a high-pass filter in the antenna transmission line and an a-c line filter of a standard variety has proven to be completely effective in eliminating the interference from a transmitter operating in one of the lower frequency amateur bands.

In general, it is suggested that commercially manufactured high-pass filters be purchased. Such units are available from a number of manufacturers at a relatively moderate cost. However, such units may be home constructed; suggested designs are given in figures 2 and 3. Types for use both with coaxial and with balanced transmission lines have been shown. In most cases the filters may be constructed in one of the small shield boxes which are now on the market. Input and output terminals may be standard connectors, or the inexpensive type of terminal strips usually used on BC and TV sets may be employed. Coaxial terminals should of course be employed when a coaxial feed line is used to the antenna. In any event the leads from the filter box to the TV set should be very short, including both the antenna lead and the ground lead to the box itself. If the leads from the box to the set have much length, they may pick up enough signal to nullify the effects of the high-pass filter.

Blocking from 50-Mc. Signals Operation on the 50-Mc. amateur band in an area where channel 2 is in use for TV imposes a special problem in the matter of blocking. The input circuits of most TV sets are sufficiently broad so that an amateur signal on the 50-Mc. band will ride through with little attenuation. Also, the normal TV antenna will have a quite large response to a signal in the 50-Mc. band since the lower limit of channel 2 is 54 Mc.

High-pass filters of the normal type simply are not capable of giving sufficient attenuation to a signal whose frequency is so close to the necessary pass band of the filter. Hence, a resonant circuit element, as illustrated in figure 1, must be used to trap out the amateur field at the input of the TV set. The trap must be tuned or the section of transmission line cut, if a section of line is to be used for a particular frequency in the 50-Mc. band. This frequency will have to be near the lower frequency limit of the 50-Mc. band to obtain adequate rejection of the amateur signal while still not materially affecting the response of the receiver to channel 2.

Elimination of Spurious Emissions All spurious emissions from amateur transmitters (ignoring harmonic signals for the time being) must be eliminated to com-

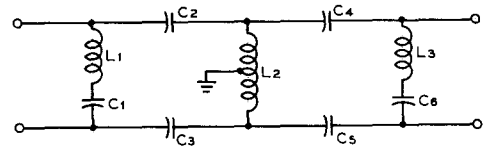

Figure 3
SERIES-DERIVED HIGH-PASS FILTER

This filter is designed for use in the 300-ohm transmission line from the TV antenna to the TV receiver. Nominal cut-off frequency is 36 Mc. and maximum rejection is at about 29 Mc.

- C₁, C₆—15- μ fd. zero-coefficient ceramic
- C₂, C₃, C₄, C₅—20- μ fd. zero-coefficient ceramic
- L₁, L₃—2.0 μ h. About 24 turns no. 28 d.c.c. wound to $\frac{5}{8}$ " on $\frac{1}{4}$ " diameter polystyrene rod. Turns should be adjusted until the coil resonates to 29 Mc. with the associated 15- μ fd. capacitor.
- L₂—0.66 μ h. 14 turns no. 28 d.c.c. wound to $\frac{5}{8}$ " on $\frac{1}{4}$ " dia. polystyrene rod. Adjust turns to resonate externally to 20 Mc. with an auxiliary 100- μ fd. capacitor whose value is accurately known.

ply with FCC regulations. But in the past many amateur transmitters have emitted spurious signals as a result of key clicks, parasitics, and overmodulation transients. In most cases the operators of the transmitters were not aware of these emissions since they were radiated only for a short distance and hence were not brought to his attention. But with one or more TV sets in the neighborhood it is probable that such spurious signals will be brought quickly to his attention.

19-2 Harmonic Radiation

After any condition of blocking at the TV receiver has been eliminated, and when the transmitter is completely free of transients and parasitic oscillations, it is probable that TVI will be eliminated in certain cases. Certainly general interference should be eliminated, particularly if the transmitter is a well designed affair operated on one of the lower frequency bands, and the station is in a high-signal TV area. But when the transmitter is to be operated on one of the higher frequency bands, and particularly in a marginal TV area, the job of TVI-proofing will just have begun. The elimination of harmonic radiation from the transmitter is a difficult and tedious job which must be done in an orderly manner if completely satisfactory results are to be obtained.

TRANSMITTER FUNDAMENTAL	2ND	3RD	4TH	5TH	6TH	7TH	8TH	9TH	10TH
7.0 7.3		21-21.9 TV I.F.			42-44 NEW TV I.F.		56-58.4 CHANNEL (2)	63-65.7 CHANNEL (3)	70-73 CHANNEL (4)
14.0 14.4		42-43 NEW TV I.F.	56-57.6 CHANNEL (2)	70-72 CHANNEL (4)	84-86.4 CHANNEL (6)		98-100.8 FM BROAD- CAST		
21.0 21.45 (TV I.F.)		63-64.35 CHANNEL (3)	84-85.8 CHANNEL (6)	105-107.25 FM BROAD- CAST				189-193 CHANNELS (9) (10)	210-214.5 CHANNEL (5)
26.96 27.23	53.92- 54.48 CHANNEL (2) ABOVE 27 MC. ONLY	80.85- 81.69 CHANNEL (5)	107.84- 108.92 FM BROAD- CAST			189 CHANNEL (7)	216 CHANNEL (3)		
28.0 29.7	56-59.4 CHANNEL (2)	84-89.1 CHANNEL (6)			168-178.2 CHANNEL (7)	196-207.9 CHANNELS (10) (11) (12)			
50.0 54.0	100-108 FM BROAD- CAST		200-216 CHANNELS (11) (12) (13)					450-486	500-540

Figure 4
HARMONICS OF THE AMATEUR BANDS

Shown are the harmonic frequency ranges of the amateur bands between 7 and 54 Mc., with the TV channels (and TV i-f systems) which are most likely to receive interference from these harmonics. Under certain conditions amateur signals in the 1.8 and 3.5 Mc. bands can cause interference as a result of direct pickup in the video systems of TV receivers which are not adequately shielded.

First it is well to become familiar with the TV channels presently assigned, with the TV intermediate frequencies commonly used, and with the channels which will receive interference from harmonics of the various amateur bands. Figures 4 and 5 give this information.

Even a short inspection of figures 4 and 5 will make obvious the seriousness of the interference which can be caused by harmonics of amateur signals in the higher frequency bands. With any sort of reasonable precautions in the design and shielding of the transmitter it is not likely that harmonics higher than the 6th will be encountered. Hence the main offenders in the way of harmonic interference will be those bands above 14-Mc.

Nature of Harmonic Interference

Investigations into the nature of the interference caused by amateur signals on the TV screen, assuming that blocking has been eliminated as described earlier in this chapter, have revealed the following facts:

1. An unmodulated carrier, such as a c-w signal with the key down or an AM signal without modulation, will give a

cross-hatch or herringbone pattern on the TV screen. This same general type of picture also will occur in the case of a narrow-band FM signal either with or without modulation.

2. A relatively strong AM signal will give in addition to the herringbone a very serious succession of light and dark bands across the TV picture.
3. A moderate strength c-w signal without transients, in the absence of overloading of the TV set, will result merely in the turning on and off of the herringbone on the picture.

To discuss condition (1) above, the herringbone is a result of the beat note between the TV video carrier and the amateur harmonic. Hence the higher the beat note the less obvious will be the resulting cross-hatch. Further, it has been shown that a much stronger signal is required to produce a discernible herringbone when the interfering harmonic is as far away as possible from the video carrier, without running into the sound carrier. Thus, as a last resort, or to eliminate the last vestige of interference after all corrective measures have been taken, operate the transmitter on a frequency such that the interfer-

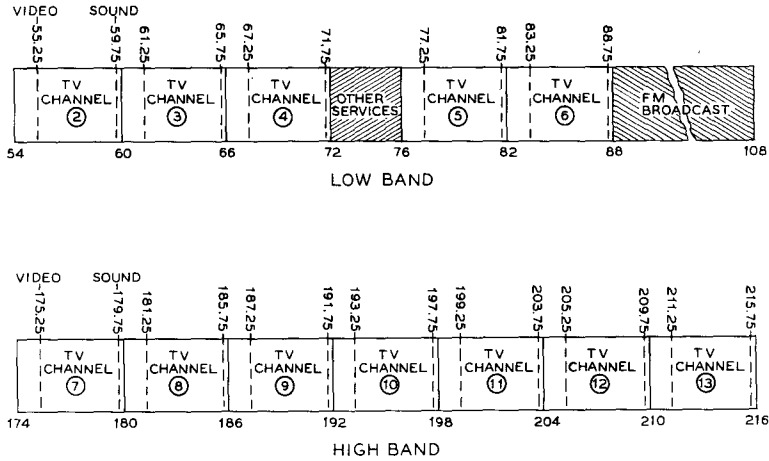

Figure 5
FREQUENCIES OF THE V-H-F TV CHANNELS.

Showing the frequency ranges of TV channels 2 through 13, with the picture carrier and sound carrier frequencies also shown.

ing harmonic will fall as far as possible from the picture carrier. The worst possible interference to the picture from a continuous carrier will be obtained when the interfering signal is very close in frequency to the video carrier.

Isolating the Source of the Interference Throughout the testing procedure it will be necessary to have some sort of indicating device as a means of determining harmonic field intensities. The best indicator for field intensities some distance from the transmitting antenna will probably be the TV receiver of some neighbor with whom friendly relations are still maintained. This person will then be able to give a check, occasionally, on the relative nature of the interference. But it will probably be necessary to go and check yourself periodically the results obtained, since the neighbor probably will not be able to give any sort of a quantitative analysis of the progress which has been made.

An additional device for checking relatively high field intensities in the vicinity of the transmitter will be almost a necessity. A simple crystal diode wavemeter, shown in figure 6 will accomplish this function. Also, it will be very helpful to have a receiver, with an S meter, capable of covering at least the 50 to 100 Mc. range and preferably the range to 216 Mc. This device may consist merely of the station receiver and a simple converter using the two halves of a 6J6 as oscillator and mixer.

The first check can best be made with the neighbor who is receiving the most serious or the most general interference. Turn on the transmitter and check all channels to determine the extent of the interference and the number of channels affected. Then disconnect the antenna and substitute a group of 100-watt lamps as a dummy load for the transmitter. Experience has shown that 8 100-watt lamps connected in two series groups of four in parallel will take the output of a kilowatt transmitter on 28 Mc. if connections are made symmetrically to the group of lamps. Then note the interference. Now remove plate voltage from the final amplifier and determine the extent of interference caused by the exciter stages.

In the average case, when the final amplifier is a beam tetrode stage and the exciter is

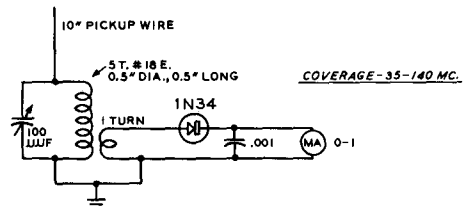

Figure 6
Crystal-diode wavemeter suitable for checking high-intensity harmonics in TV region.

relatively low powered and adequately shielded, it will be found that the interference drops materially when the antenna is removed and a dummy load substituted. It will also be found in such an average case that the interference will stop when the exciter only is operating.

Transmitter Power Level It should be made clear at this point that the level of power used at the transmitter is not of

great significance in the basic harmonic reduction problem. The difference in power level between a 20-watt transmitter and one rated at a kilowatt is only a matter of about 17 db. Yet the degree of harmonic attenuation required to eliminate interference caused by harmonic radiation is from 80 to 120 db, depending upon the TV signal strength in the vicinity. This is not to say that it is not a simpler job to eliminate harmonic interference from a low-power transmitter than from a kilowatt equipment. It is simpler to suppress harmonic radiation from a low-power transmitter simply because it is a much easier problem to shield a low-power unit, and the filters for the leads which enter the transmitter enclosure may be constructed less expensively and smaller for a low-power unit.

19-3 Low-Pass Filters

After the transmitter has been shielded, and all power leads have been filtered in such a manner that the transmitter shielding has not been rendered ineffective, the only remaining available exit for harmonic energy lies in the antenna transmission line. Hence the main burden of harmonic attenuation will fall on the low-pass filter installed between the output of the transmitter and the antenna system.

Experience has shown that the low-pass filter can best be installed externally to the main transmitter enclosure, and that the transmission line from the transmitter to the low-pass filter should be of the coaxial type. Hence the majority of low-pass filters are designed for a characteristic impedance of 52 ohms, so that RG-8/U cable (or RG-58/U for a small transmitter) may be used between the output of the transmitter and the antenna transmission line or the antenna tuner.

Transmitting-type low-pass filters for amateur use usually are designed in such a manner as to pass frequencies up to about 30 Mc. without attenuation. The nominal cutoff frequency of the filters is usually between 38 and 45 Mc., and m -derived sections with maximum attenuation in channel 2 usually are included. Well-designed filters capable of carrying any power level up to one kilowatt are

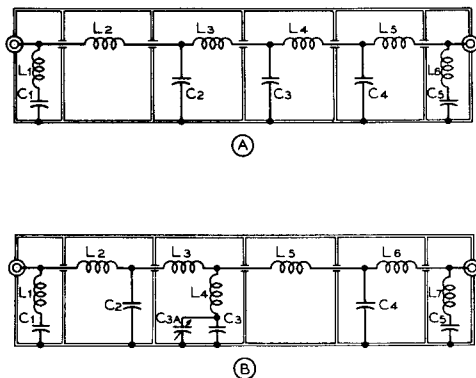

Figure 7

LOW-PASS FILTER SCHEMATIC DIAGRAMS

The filter illustrated at (A) uses m -derived terminating half sections at each end, with three constant- k mid-sections. The filter at (B) is essentially the same except that the center section has been changed to act as an m -derived section which can be designed to offer maximum attenuation to channels 2, 4, 5, or 6 in accordance with the constants given below. Cutoff frequency is 45 Mc. in all cases. All coils, except L_4 in (B) above, are wound $\frac{1}{2}$ " i.d. with 8 turns per inch.

The (A) Filter

C_1, C_5 —41.5 μ fd. (40 μ fd. will be found suitable.)

C_2, C_3, C_4 —136 μ fd. (130 to 140 μ fd. may be used.)

L_1, L_6 —0.2 μ h; 3 $\frac{1}{2}$ t. no. 14

L_2, L_5 —0.3 μ h; 5 t. no. 12

L_3, L_4 —0.37 μ h; 6 $\frac{1}{2}$ t. no. 12

The (B) Filter with Mid-Section tuned to Channel 2 (58 Mc.)

C_1, C_5 —41.5 μ fd.

C_2, C_4 —136 μ fd.

C_3 —87 μ fd. (50 μ fd. fixed and 75 μ fd. variable in parallel.)

L_1, L_7 —0.2 μ h; 3 $\frac{1}{2}$ t. no. 14

L_2, L_3, L_5, L_6 —0.3 μ h; 5 t. no. 12

L_4 —0.09 μ h; 2 t. no. 14 $\frac{1}{2}$ " dia. by $\frac{1}{4}$ " long

The (B) Filter with Mid-Section tuned to Channel 4 (71 Mc.). All components same except that:

C_3 —106 μ fd.

L_3, L_5 —0.33 μ h; 6 t. no. 12

L_4 —0.05 μ h; 1 $\frac{1}{2}$ t. no. 14, $\frac{3}{8}$ " dia. by $\frac{3}{8}$ " long.

The (B) Filter with Mid-Section tuned to Channel 5 (81 Mc.). Change the following:

C_3 —113 μ fd.

L_3, L_5 —0.34 μ h; 6 t. no. 12

L_4 —0.033 μ h; 1 t. no. 14 $\frac{3}{8}$ " dia.

The (B) Filter with Mid-Section tuned to Channel 6 (86 Mc.). All components are essentially the same except that the theoretical value of L_4 is changed to 0.03 μ h., and the capacitance of C_3 is changed to 117 μ fd.

available commercially from several manufacturers. Alternatively, filters in kit form are available from several manufacturers at a somewhat lower price. Effective filters may be home constructed, if the test equipment is available and if sufficient care is taken in the construction of the assembly.

Construction of Low-Pass Filters Figures 7, 8 and 9 illustrate high-performance low-pass filters which are suitable for home construction. All are constructed in slip-cover aluminum boxes (ICA no. 29110) with dimensions of 17 by 3 by 2 1/4 inches. Five aluminum baffle plates have been installed in the chassis to make six shielded sections within the enclosure. Feed-through bushings between the shielded sections are Johnson no. 135-55.

Both the (A) and (B) filter types are designed for a nominal cut-off frequency of 45 Mc., with a frequency of maximum rejection at about 57 Mc. as established by the terminating half-sections at each end. Characteristic impedance is 52 ohms in all cases. The alternative filter designs diagrammed in figure 7B have provision for an additional rejection trap in the center of the filter unit which may be designed to offer maximum rejection in channel 2, 4, 5, or 6, depending upon which channel is likely to be received in the area in question. The only components which must be changed when changing the frequency of the maximum rejection notch in the center of the filter unit are inductors L_3 , L_4 , and L_5 , and capacitor C_3 . A trimmer capacitor has been included as a portion of C_3 , so that the frequency of maximum rejection can be tuned accurately to the desired value. Reference to figures 5 and 6 will show the amateur bands which are

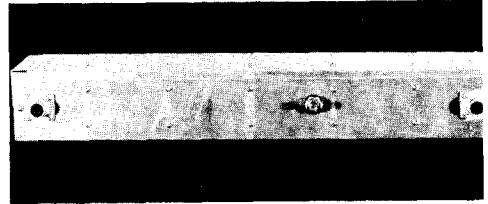

Figure 8
PHOTOGRAPH OF THE (B) FILTER WITH THE COVER IN PLACE

most likely to cause interference to specific TV channels.

Either high-power or low-power components may be used in the filters diagrammed in figure 7. With the small Centralab TCZ zero-coefficient ceramic capacitors used in the filter units of figure 7A or figure 7B, power levels up to 200 watts output may be used without danger of damage to the capacitors, *provided* the filter is feeding a 52-ohm resistive load. It may be practicable to use higher levels of power with this type of ceramic capacitor in the filter, but at a power level of 200 watts on the 28-Mc. band the capacitors run just perceptibly warm to the touch. As a point of interest, it is the current rating which is of significance to the capacitors used in filters such as illustrated. Since current ratings for small capacitors such as these are not readily available, it is not possible to establish an accurate power rating for such a unit. The high-power unit illustrated in figure 9, which uses Centralab type 850S and 854S capacitors,

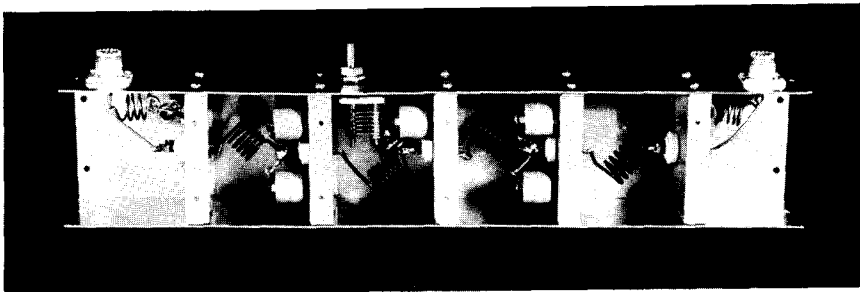

Figure 9
PHOTOGRAPH OF THE (B) FILTER WITH COVER REMOVED

The mid-section in this filter is adjusted for maximum rejection of channel 4. Note that the main coils of the filter are mounted at an angle of about 45 degrees so that there will be minimum inductive coupling from one section to the next through the holes in the aluminum partitions. Mounting the coils in this manner was found to give a measurable improvement in the attenuation characteristics of the filter.

has proven quite suitable for power levels up to one kilowatt.

Capacitors C_1 , C_2 , C_4 , and C_5 can be standard manufactured units with normal 5 per cent tolerance. The coils for the end sections can be wound to the dimensions given (L_1 , L_6 , and L_7). Then the resonant frequency of the series resonant end sections should be checked with a grid-dip meter, after the adjacent input or output terminal has been shorted with a very short lead. The coils should be squeezed or spread until resonance occurs at 57 Mc.

The intermediate m -derived section in the filter of figure 7B may also be checked with a grid-dip meter for resonance at the correct rejection frequency, after the hot end of L_4 has been temporarily grounded with a low-inductance lead. The variable capacitor portion of C_3 can be tuned until resonance at the correct frequency has been obtained. Note that there is so little difference between the constants of this intermediate section for channels 5 and 6 that variation in the setting of C_3 will tune to either channel without materially changing the operation of the filter.

The coils in the intermediate sections of the filter (L_2 , L_3 , L_4 , and L_5 in figure 7A, and L_2 , L_3 , L_5 , and L_6 in figure 7B) may be checked most conveniently outside the filter unit with the aid of a small ceramic capacitor of known value and a grid-dip meter. The ceramic capacitor is paralleled across the small coil with the shortest possible leads. Then the assembly is placed atop a cardboard box and the resonant frequency checked with a grid-dip meter. A *Shure reactance slide rule* may be used to ascertain the correct resonant frequency for the desired L-C combination and the coil altered until the desired resonant frequency is attained. The coil may then be installed in the filter unit, making sure that it is not squeezed or compressed as it is being installed. However, if the coils are wound exactly as given under figure 10, the filter may be assembled with reasonable assurance that it will operate as designed.

Using Low-Pass Filters The low-pass filter connected in the output transmission line of the transmitter is capable of affording an enormous degree of harmonic attenuation. However, the filter must be operated in the correct manner or the results obtained will not be up to expectations.

In the first place, all direct radiation from the transmitter and its control and power leads must be suppressed. This subject has been discussed in the previous section. Secondly, the filter must be operated into a load impedance approximately equal to its design characteristic impedance. The filter itself will

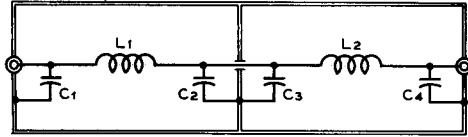

Figure 10
SCHEMATIC OF THE SINGLE-SECTION
HALF-WAVE FILTER

The constants given below are for a characteristic impedance of 52 ohms, for use with RG-8/U and RG-58/U cable. Coil L_1 should be checked for resonance at the operating frequency with C_1 , and the same with L_2 and C_4 . This check can be made by soldering a low-inductance grounding strap to the lead between L_1 and L_2 where it passes through the shield. When the coils have been trimmed to resonance with a grid-dip meter, the grounding strap should of course be removed. This filter type will give an attenuation of about 30 db to the second harmonic, about 48 db to the third, about 60 db to the fourth, 67 to the fifth, and so on increasing at a rate of about 30 db per octave.

C_1, C_2, C_3, C_4 —Silver mica or small ceramic for low power, transmitting type ceramic for high power. Capacitance for different bands is given below:

160 meters	—1700 $\mu\mu\text{fd}$.
80 meters	—850 $\mu\mu\text{fd}$.
40 meters	—440 $\mu\mu\text{fd}$.
20 meters	—220 $\mu\mu\text{fd}$.
10 meters	—110 $\mu\mu\text{fd}$.
6 meters	—60 $\mu\mu\text{fd}$.

L_1, L_2 —May be made up of sections of B&W Mini-inductor for power levels below 250 watts, or of no. 12 enam. for power up to one kilowatt. Approximate dimensions for the coils are given below, but the coils should be trimmed to resonate at the proper frequency with a grid-dip meter as discussed above. All coils except the ones for 160 meters are wound 8 turns per inch.

160 meters	—4.2 μh ; 22 turns no. 16 enam., 1" dia. 2" long
80 meters	—2.1 μh ; 13 t. 1" dia. (No. 3014 Mini-inductor or no. 12)
40 meters	—1.1 μh ; 8 t. 1" dia. (No. 3014 or no. 12 at 8 t.p.i.)
20 meters	—0.55 μh ; 7 t. $\frac{3}{4}$ " dia. (No. 3010 or no. 12 at 8 t.p.i.)
10 meters	—0.3 μh ; 6 t. $\frac{1}{2}$ " dia. (No. 3002 or no. 12 at 8 t.p.i.)
6 meters	—0.17 μh ; 4 t. $\frac{1}{2}$ " dia. (No. 3002 or no. 12 at 8 t.p.i.)

have very low losses (usually less than 0.5 db) when operated into its nominal value of resistive load. But if the filter is mis-terminated its losses will become excessive, and it will not present the correct value of load impedance to the transmitter.

If a filter, being fed from a high-power transmitter, is operated into an incorrect termination it may be damaged; the coils may be overheated and the capacitors destroyed as a result of excessive r-f currents. Hence it is wise, when first installing a low-pass filter,

Figure 11
**HALF-WAVE FILTER
 FOR THE 28-MC. BAND**
*Showing one possible type
 of construction of a 52-ohm
 half-wave filter for relative-
 ly low power operation on
 the 28-Mc. band.*

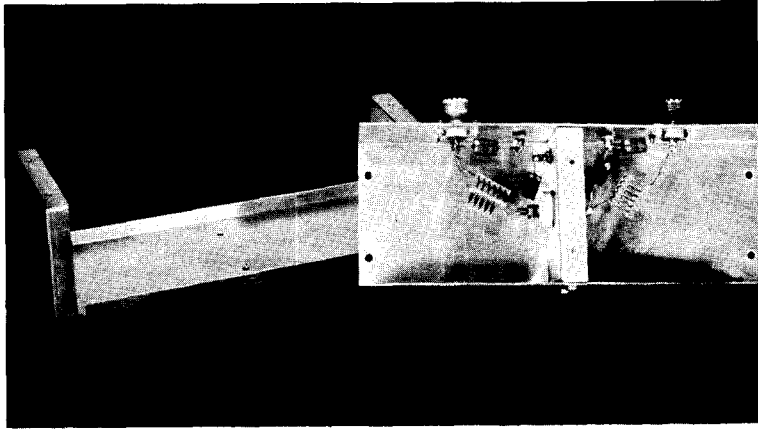

to check the standing-wave ratio of the load being presented to the output of the filter with a standing-wave meter of any of the conventional types. Then the antenna termination or the antenna coupled should be adjusted, with low power on the transmitter, until the s.w.r. of the load being presented to the filter is less than 2.0, and preferably below 1.5.

Half-Wave Filters Half-wave filters ("Harmonikers") have been discussed in various publications including the Nov.-Dec. 1949 *GE Ham News*. Such filters are relatively simple and offer the advantage that they present the same value of impedance at their input terminals as appears as load across their output terminals. Such filters normally are used as one-band affairs, and they offer high attenuation only to the third and higher harmonics. Design data on the half-wave filter is given in figure 10. Construction of half-wave filters is illustrated in figure 11.

19-4 **Broadcast Interference**

Interference to the reception of signals in the broadcast band (540 to 1600 kc.) or in the FM broadcast band (88 to 108 Mc.) by amateur transmissions is a serious matter to those amateurs living in densely populated areas. Although broadcast interference has recently been overshadowed by the seriousness of television interference, the condition of BCI is still present.

In general, signals from a transmitter operating properly are not picked up by receivers tuned to other frequencies unless the receiver is of inferior design, or is in poor condition. Therefore, if the receiver is of good design

and is in good repair, the burden of rectifying the trouble rests with the owner of the interfering station. Phone and c-w stations both are capable of causing broadcast interference, key-click annoyance from the code transmitters being particularly objectionable.

A knowledge of each of the several types of broadcast interference, their cause, and methods of eliminating them is necessary for the successful disposition of this trouble. An effective method of combating one variety of interference is often of no value whatever in the correction of another type. Broadcast interference seldom can be cured by "rule of thumb" procedure.

Broadcast interference, as covered in this section refers primarily to standard (amplitude modulated, 550-1600 kc.) broadcast. Interference with FM broadcast reception is much less common, due to the wide separation in frequency between the FM broadcast band and the more popular amateur bands, and due also to the limiting action which exists in all types of FM receivers. Occasional interference with FM broadcast by a harmonic of an amateur transmitter has been reported; if this condition is encountered, it may be eliminated by the procedures discussed in the first portion of this chapter under Television Interference.

The use of frequency-modulation transmission by an amateur station is likely to result in much less interference to broadcast reception than either amplitude-modulated telephony or straight keyed c.w. This is true because, insofar as the broadcast receiver is concerned, the amateur FM transmission will consist of a plain unmodulated carrier. There will be no key clicks or voice reception picked up by the b-c-l set (unless it happens to be an FM receiver which might pick up a harmonic of the signal), although there might be a slight click when the transmitter is put on or taken

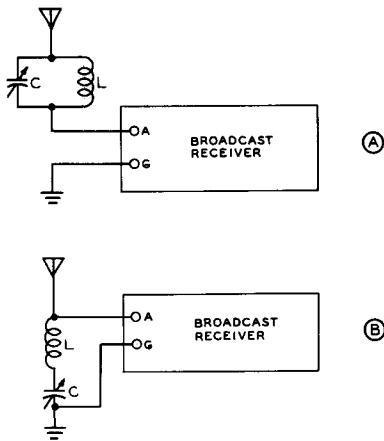

Figure 12

WAVE-TRAP CIRCUITS

The circuit at (A) is the most common arrangement, but the circuit at (B) may give improved results under certain conditions. Manufactured wave traps for the desired band of operation may be purchased or the traps may be assembled from the data given in figure 14.

off the air. This is one reason why narrow-band FM has become so popular with phone enthusiasts who reside in densely populated areas.

Interference Classifications Depending upon whether it is traceable directly to causes within the station or within the receiver, broadcast interference may be divided into two main classes. For example, that type of interference due to transmitter over-modulation is at once listed as being caused by improper operation, while an interfering signal that tunes in and out with a broadcast station is probably an indication of cross modulation or image response in the receiver, and the poorly-designed input stage of the receiver is held liable. The various types of interference and recommended cures will be discussed in the following paragraphs.

Blanketing This is not a tunable effect, but a total blocking of the receiver. A more or less complete "washout" covers the entire receiver range when the carrier is switched on. This produces either a complete blotting out of all broadcast stations, or else knocks down their volume several decibels—depending upon the severity of the interference. Voice modulation of the carrier causing the blanketing will be highly distorted or even

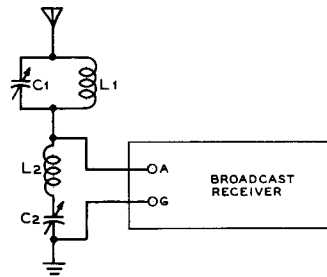

Figure 13
HIGH-ATTENUATION WAVE-TRAP
CIRCUIT

The two circuits may be tuned to the same frequency for highest attenuation of a strong signal, or the two traps may be tuned separately for different bands of operation.

unintelligible. Keying of the carrier which produces the blanketing will cause an annoying fluctuation in the volume of the broadcast signals.

Blanketing generally occurs in the immediate neighborhood (inductive field) of a powerful transmitter, the affected area being directly proportional to the power of the transmitter. Also it is more prevalent with transmitters which operate in the 160-meter and 80-meter bands, as compared to those on the higher frequencies.

The remedies are to (1) shorten the receiving antenna and thereby shift its resonant frequency, or (2) remove it to the interior of the building, (3) change the direction of either the receiving or transmitting antenna to minimize their mutual coupling, or (4) keep the interfering signal from entering the receiver input circuit by installing a wavetrapped to the signal frequency (see figure 12) or a low-pass filter as shown in figure 21.

A suitable wave-trap is quite simple in construction, consisting only of a coil and midget variable capacitor. When the trap circuit is tuned to the frequency of the interfering signal, little of the interfering voltage reaches the grid of the first tube. Commercially manufactured wave-traps are available from several concerns, including the J. W. Miller Co. in Los Angeles. However, the majority of amateurs prefer to construct the traps from spare components selected from the "junk box."

The circuit shown in figure 13 is particularly effective because it consists of two traps. The shunt trap blocks or rejects the frequency to which it is tuned, while the series trap across the antenna and ground terminals of the receiver provides a very low impedance path to ground at the frequency to

BAND	COIL, L	CAPACITOR, C
1.8 Mc.	1 inch no. 30 enam. closewound on 1" form	75- μ fd. var.
3.5 Mc.	42 turns no. 30 enam. closewound on 1" form	50- μ fd. var.
7.0 Mc.	23 turns no. 24 enam. closewound on 1" form	50- μ fd. var.
14 Mc.	10 turns no. 24 enam. closewound on 1" form	50- μ fd. var.
21 Mc.	7 turns no. 24 enam. closewound on 1" form	50- μ fd. var.
28 Mc.	4 turns no. 24 enam. closewound on 1" form	25- μ fd. var.
50 Mc.	3 turns no. 24 enam. spaced 1/2" on 1" form	25- μ fd. var.

Figure 14
COIL AND CAPACITOR TABLE FOR AMATEUR-BAND WAVETRAPS

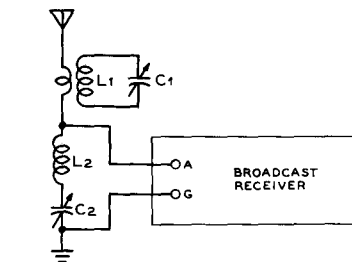

Figure 15
MODIFICATION OF THE FIGURE 13 CIRCUIT

In this circuit arrangement the parallel-tuned tank is inductively coupled to the antenna lead with a 3 to 6 turn link instead of being placed directly in series with the antenna lead.

which it is tuned and by-passes the signal to ground. In moderate interference cases, either the shunt or series trap may be used alone, while similarly, one trap may be tuned to one of the frequencies of the interfering transmitter and the other trap to a different interfering frequency. In either case, each trap is effective over but a small frequency range and must be readjusted for other frequencies.

The wave-trap must be installed as close to the receiver antenna terminal as practicable, hence it should be as small in size as possible. The variable capacitor may be a midget air-tuned trimmer type, and the coil may be wound on a 1-inch dia. form. The table of figure 14 gives winding data for wave-traps built around standard variable capacitors. For best results, both a shunt and a series trap should be employed as shown.

Figure 15 shows a two-circuit coupled wave-trap that is somewhat sharper in tuning and more efficacious. The specifications for the secondary coil L_1 may be obtained from the table of figure 14. The primary coil of the shunt trap consists of 3 to 5 closewound turns of the same size wire wound in the same direction on the same form as L_1 and separated from the latter by 1/2 of an inch.

Overmodulation A carrier modulated in excess of 100 per cent acquires sharp cutoff periods which give rise to transients. These transients create a broad signal and generate spurious responses. Transients caused by overmodulation of a radio-telephone signal may at the same time bring about impact or shock excitation of nearby receiving antennas and power lines, generating interfering signals in that manner.

Broadcast interference due to overmodulation is frequently encountered. The remedy is to reduce the modulation percentage or to use a clipper-filter system or a high-level splatter suppressor in the speech circuit of the transmitter.

Cross Modulation Cross modulation or *cross talk* is characterized by the amateur signal riding in on top of a strong broadcast signal. There is usually no heterodyne note, the amateur signal being tuned in and out with the program carriers.

This effect is due frequently to a faulty input stage in the affected receiver. Modulation of the interfering carrier will swing the operating point of the input tube. This type of trouble is seldom experienced when a variable- μ tube is used in the input stage.

Where the receiver is too ancient to incorporate such a tube, and is probably poorly shielded at the same time, it will be better to attach a wave-trap of the type shown in figure 12 rather than to attempt rebuilding of the receiver. The addition of a good ground and a shield can over the input tube often adds to the effectiveness of the wave-trap.

Transmission via Capacitive Coupling A small amount of capacitive coupling is now widely used in receiver r.f. and antenna transformers as a gain booster at the high-frequency end of the tuning range. The coupling capacitance is obtained by means of a small loop of wire cemented close to the grid end of the secondary winding, with one end directly connected to the plate or antenna end of the primary winding. (See figure 16.)

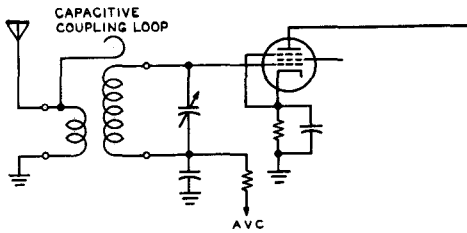

Figure 16
CAPACITIVE BOOST COUPLING
CIRCUIT

Such circuits, included within the broadcast receiver to bring up the stage gain at the high-frequency end of the tuning range, have a tendency to increase the susceptibility of the receiver to interference from amateur-band transmissions.

It is easily seen that a small capacitor at this position will favor the coupling of the higher frequencies. This type of capacitive coupling in the receiver coils will tend to pass amateur high-frequency signals into a receiver tuned to broadcast frequencies.

The amount of capacitive coupling may be reduced to eliminate interference by moving the coupling turn further away from the secondary coil. However, a simple wave-trap of the type shown in figure 12, inserted at the antenna input terminal, will generally accomplish the same result and is more to be recommended than reducing the amount of capacitive coupling (which lowers the receiver gain at the high-frequency end of the broadcast band). Should the wave-trap alone not suffice, it will be necessary to resort to a reduction in the coupling capacitance.

In some simple broadcast receivers, capacitive coupling is obtained by closely coupled primary and secondary coils, or as a result of running a long primary or antenna lead close to the secondary coil of an unshielded antenna coupler.

Phantoms With two strong local carriers applied to a non-linear impedance, the beat note resulting from cross-modulation between them may fall on some frequency within the broadcast band and will be audible at that point. If such a "phantom" signal falls on a local broadcast frequency, there will be heterodyne interference as well. This is a common occurrence with broadcast receivers in the neighborhood of two amateur stations, or an amateur and a police station. It also sometimes occurs when only one of the stations is located in the immediate vicinity.

As an example; an amateur signal on 3514 kc. might beat with a local 2414-kc. police carrier to produce a 1100-kc. phantom. If the two carriers are strong enough in the vicinity of a circuit which can cause rectification, the 1100-kc. phantom will be heard in the broadcast band. A poor contact between two oxidized wires can produce rectification.

Two stations must be transmitting simultaneously to produce a phantom signal; when either station goes off the air the phantom disappears. Hence, this type of interference is apt to be reported as highly intermittent and might be difficult to duplicate unless a test oscillator is used "on location" to simulate the missing station. Such interference cannot be remedied at the transmitter, and often the rectification takes place some distance from the receivers. In such occurrences it is most difficult to locate the source of the trouble.

It will also be apparent that a phantom might fall on the intermediate frequency of a simple superhet receiver and cause interference of the untunable variety if the manufacturer has not provided an i-f wave-trap in the antenna circuit.

This particular type of phantom may, in addition to causing i-f interference, generate harmonics which may be tuned in and out with heterodyne whistles from one end of the receiver dial to the other. It is in this manner that *birdies* often result from the operation of nearby amateur stations.

When one component of a phantom is a steady, unmodulated carrier, only the intelligence present on the other carrier is conveyed to the broadcast receiver.

Phantom signals almost always may be identified by the suddenness with which they are interrupted, signaling withdrawal of one party to the union. This is especially baffling to the inexperienced interference-locator, who observes that the interference suddenly disappears, even though his own transmitter remains in operation.

If the mixing or rectification is taking place in the receiver itself, a phantom signal may be eliminated by removing either one of the contributing signals from the receiver input circuit. A wave-trap of the type shown in figure 12, tuned to either signal, will do the trick. If the rectification is taking place outside the receiver, the wave-trap should be tuned to the frequency of the phantom, instead of to one of its components. I-f wave-traps may be built around a 2.5-millihenry r-f choke as the inductor, and a compression-type mica padding capacitor. The capacitor should have a capacitance range of 250-525 $\mu\text{fd.}$ for the 175- and 206-kc. intermediate frequencies; 65-175 $\mu\text{fd.}$ for 260-kc. and other intermedi-

ates lying between 250- and 400-kc; and 17–80 $\mu\text{fd.}$ for 456-, 465-, 495-, and 500-kc. Slightly more capacitance will be required for resonance with a 2.1 millihenry choke.

Spurious Emissions This sort of interference arises from the transmitter itself. The radiation of any signal (other than the intended carrier frequency) by an amateur station is prohibited by FCC regulations. Spurious radiation may be traced to imperfect neutralization, parasitic oscillations in the r-f or modulator stages, or to "broadcast-band" variable-frequency oscillators or e.c.o.'s.

Low-frequency parasitics may actually occur on broadcast frequencies or their near subharmonics, causing direct interference to programs. An all-wave monitor operated in the vicinity of the transmitter will detect these spurious signals.

The remedy will be obvious in individual cases. Elsewhere in this book are discussed methods of complete neutralization and the suppression of parasitic oscillations in r-f and audio stages.

A-c/d-c Receivers Inexpensive table-model a-c/d-c receivers are particularly susceptible to interference from amateur transmissions. In fact, it may be said with a fair degree of assurance that the majority of BCI encountered by amateurs operating in the 1.8-Mc. to 29-Mc. range is a result of these inexpensive receivers. In most cases the receivers are at fault; but this does not absolve the amateur of his responsibility in attempting to eliminate the interference.

Stray Receiver Rectification In most cases of interference to inexpensive receivers, particularly those of the a-c/d-c type, it will be found that stray receiver rectification is causing the trouble. The offending stage usually will be found to be a high-mu triode as the first audio stage following the second detector. Tubes of this type are quite non-linear in their grid characteristic, and hence will readily rectify any r-f signal appearing between grid and cathode. The r-f signal may get to the tube as a result of direct signal pickup due to the lack of shielding, but more commonly will be fed to the tube from the power line as a result of the series heater string.

The remedy for this condition is simply to insure that the cathode and grid of the high-mu audio tube (usually a 12SQ7 or equivalent) are at the same r-f potential. This is accomplished by placing an r-f by-pass capacitor with the shortest possible leads directly from grid to cathode, and then adding an impedance in the lead from the volume control to the grid of the

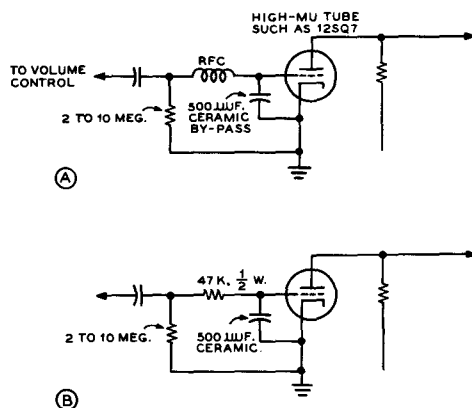

Figure 17
CIRCUITS FOR ELIMINATING AUDIO-STAGE RECTIFICATION

audio tube. The impedance may be an amateur band r-f choke (such as a National R-100U) for best results, but for a majority of cases it will be found that a 47,000-ohm $\frac{1}{2}$ -watt resistor in series with this lead will give satisfactory operation. Suitable circuits for such an operation on the receiver are given in figure 17.

In many a-c-d-c receivers there is no r-f by-pass included across the plate supply rectifier for the set. If there is an appreciable level of r-f signal on the power line feeding the receiver, r-f rectification in the power rectifier of the receiver can cause a particularly bad type of interference which may be received on other broadcast receivers in the vicinity in addition to the one causing the rectification. The soldering of a 0.01- $\mu\text{fd.}$ disc ceramic capacitor directly from anode to cathode of the power rectifier (whether it is of the vacuum-tube or selenium-rectifier type) usually will by-pass the r-f signal across the rectifier and thus eliminate the difficulty.

"Floating" Volume Control Shafts Several sets have been encountered where there was only a slightly interfering signal; but, upon placing one's hand up to the volume control, the signal would greatly increase. Investigation revealed that the volume control was installed with its shaft insulated from ground. The control itself was connected to a critical part of a circuit, in many instances to the grid of a high-gain audio stage. The cure is to install a volume control with *all* the terminals insulated from the shaft, and then to ground the shaft.

BAND	COIL, L	CAPACITOR, C
3.5 Mc.	17 turns no. 14 enameled 3-inch diameter 2¼-inch length	100- μ fd. variable
7.0 Mc.	11 turns no. 14 enameled 2½-inch diameter 1½-inch length	100- μ fd. variable
14 and 21 Mc.	4 turns no. 10 enameled 3-inch diameter 1⅝-inch length	100- μ fd. variable
27 and 28 Mc.	3 turns ¼-inch o.d. copper tubing 2-inch diameter 1-inch length	100- μ fd. variable

Figure 18
COIL AND CAPACITOR TABLE
FOR A-C LINE TRAPS

Power-Line Pickup When radio-frequency energy from a radio transmitter enters a broadcast receiver through the a-c power lines, it has either been fed back into the lighting system by the offending transmitter, or picked up from the air by over-head power lines. Underground lines are seldom responsible for spreading this interference.

To check the path whereby the interfering signals reach the line, it is only necessary to replace the transmitting antenna with a dummy antenna and adjust the transmitter for maximum output. If the interference then ceases, overhead lines have been picking up the energy. The trouble can be cleared up by installing a wave-trap or a commercial line filter in the power lines at the receiver. If the receiver is reasonably close to the transmitter, it is very doubtful that changing the direction of the transmitting antenna to right angles with the overhead lines will eliminate the trouble.

If, on the contrary, the interference continues when the transmitter is connected to the dummy antenna, radio-frequency energy is being fed directly into the power line by the transmitter, and the station must be inspected to determine the cause.

One of the following reasons for the trouble will usually be found: (1) the r-f stages are not sufficiently bypassed and/or choked, (2) the antenna coupling system is not performing efficiently, (3) the power transformers have no electrostatic shields; or, if shields are present, they are ungrounded, (4) power lines are running too close to an antenna or r-f circuits carrying high currents. If none of these causes

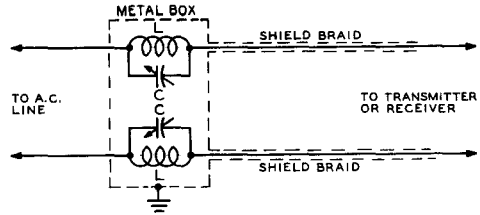

Figure 19
RESONANT POWER-LINE
WAVE-TRAP CIRCUIT

The resonant type of power-line filter is more effective than the more conventional "brute force" type of line filter, but requires tuning to the operating frequency of the transmitter.

apply, wave-traps must be installed in the power lines at the transmitter to remove r-f energy passing back into the lighting system.

The wave-traps used in the power lines at transmitter or receiver must be capable of passing relatively high current. The coils are accordingly wound with heavy wire. Figure 18 lists the specifications for power line wave-trap coils, while figure 19 illustrates the method of connecting these wave-traps. Observe that these traps are enclosed in a shield box of heavy iron or steel, well grounded.

All-Wave Receivers Each complete-coverage home receiver is a potential source of annoyance to the transmitting amateur. The novice short-wave broadcast-listener who tunes in an amateur station often considers it an interfering signal, and complains accordingly.

Neither selectivity nor image rejection in most of these sets is comparable to those properties in a communication receiver. The result is that an amateur signal will occupy too much dial space and appear at more than one point, giving rise to interference on adjacent channels and distant channels as well.

If carrier-frequency harmonics are present in the amateur transmission, serious interference will result at the all-wave receiver. The harmonics may, if the carrier frequency has been so unfortunately chosen, fall directly upon a favorite short-wave broadcast station and arouse warranted objection.

The amateur is apt to be blamed, too, for transmissions for which he is not responsible, so great is the public ignorance of short-wave allocations and signals. Owners of all-wave receivers have been quick to ascribe to amateur stations all signals they hear from tape machines and V-wheels, as well as stray tones and heterodyne flutters.

The amateur cannot be held responsible when his carrier is deliberately tuned in on an all-wave receiver. Neither is he accountable for the width of his signal on the receiver dial, or for the strength of image repeat points, if it can be proven that the receiver design does not afford good selectivity and image rejection.

If he so desires, the amateur (or the owner of the receiver) might sharpen up the received signal somewhat by shortening the receiving antenna. Set retailers often supply quite a sizeable antenna with all-wave receivers, but most of the time these sets perform almost as well with a few feet of inside antenna.

The amateur is accountable for harmonics of his carrier frequency. Such emissions are unlawful in the first place, and he must take all steps necessary to their suppression. Practical suggestions for the elimination of harmonics have been given earlier in this chapter under Television Interference.

Image Interference In addition to those types of interference already discussed, there are two more which are common to superhet receivers. The prevalence of these types is of great concern to the amateur, although the responsibility for their existence more properly rests with the broadcast receiver.

The mechanism whereby image production takes place may be explained in the following manner: when the first detector is set to the frequency of an incoming signal, the high-frequency oscillator is operating on another frequency which differs from the signal by the number of kilocycles of the intermediate frequency. Now, with the setting of these two stages undisturbed, there is another signal which will beat with the high-frequency oscillator to produce an i-f signal. This other signal is the so-called *image*, which is separated from the desired signal by twice the intermediate frequency.

Thus, in a receiver with 175-kc. i.f., tuned to 1000 kc.: the h-f oscillator is operating on 1175 kc., and a signal on 1350 kc. (1000 kc. plus 2 x 175 kc.) will beat with this 1175 kc. oscillator frequency to produce the 175-kc. i-f signal. Similarly, when the same receiver is tuned to 1400 kc., an amateur signal on 1750 kc. can come through.

If the image appears only a few cycles or kilocycles from a broadcast carrier, heterodyne interference will be present as well. Otherwise, it will be tuned in and out in the manner of a station operating in the broadcast band. Sharpness of tuning will be comparable to that of broadcast stations producing the same a-v-c voltage at the receiver.

The second variety of superhet interference is the result of harmonics of the receiver h-f oscillator beating with amateur carriers to produce the intermediate frequency of the receiver. The amateur transmitter will always be found to be on a frequency equal to some harmonic of the receiver h-f oscillator, *plus or minus the intermediate frequency*.

As an example: when a broadcast superhet with 465-kc. i.f. is tuned to 1000 kc., its high-frequency oscillator operates on 1465 kc. The third harmonic of this oscillator frequency is 4395 kc., which will beat with an amateur signal on 3930 kc. to send a signal through the i-f amplifier. The 3930 kc. signal would be tuned in at the 1000-kc. point on the dial.

Some oscillator harmonics are so related to amateur frequencies that more than one point of interference will occur on the receiver dial. Thus, a 3500-kc. signal may be tuned in at six points on the dial of a nearby broadcast superhet having 175 kc. i.f. and no r-f stage.

Insofar as remedies for image and harmonic superhet interference are concerned, it is well to remember that *if* the amateur signal did not in the first place reach the input stage of the receiver, the annoyance would not have been created. It is therefore good policy to try to eliminate it by means of a wave-trap or low-pass filter. Broadcast superhets are not always the acme of good shielding, however, and the amateur signal is apt to enter the circuit through channels other than the input circuit. If a wave-trap or filter will not cure the trouble, the only alternative will be to attempt

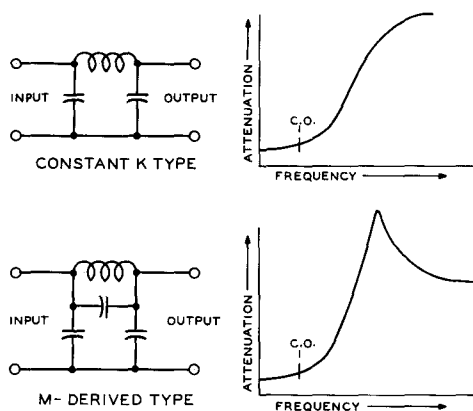

Figure 20

TYPES OF LOW-PASS FILTERS

Filters such as these may be used in the circuit between the antenna and the input of the receiver.

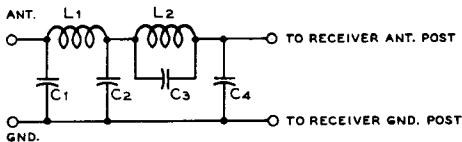

Figure 21
COMPOSITE LOW-PASS FILTER
CIRCUIT

This filter is highly effective in reducing broadcast interference from all high frequency stations, and requires no tuning. Constants for 400 ohm terminal impedance and 1600 kc. cutoff are as follows: L_1 , 65 turns no. 22 d.c.c. closewound on 1½ in. dia. form. L_2 , 41 turns ditto, not coupled to L_1 . C_1 , 250 μfd . fixed mica capacitor. C_2 , 400 μfd . fixed mica capacitor. C_3 and C_4 , 150 μfd . fixed mica capacitors, former of 5% tolerance. With some receivers, better results will be obtained with a 200 ohm carbon resistor inserted between the filter and antenna post on the receiver. With other receivers the effectiveness will be improved with a 600 ohm carbon resistor placed between the antenna post to the ground post on the receiver. The filter should be placed as close to the receiver terminals as possible.

to select a transmitter frequency such that neither image nor harmonic interference will be set up on favorite stations in the susceptible receivers. The equation given earlier may be used to determine the proper frequencies.

Low Pass Filters The greatest drawback of the wave-trap is the fact that it is a single-frequency device; i.e.—it may be set to reject at one time only one frequency (or, at best, an extremely narrow band of frequencies). Each time the frequency of the interfering transmitter is changed, every wave-trap tuned to it must be retuned. A much more satisfactory device is the *wave filter* which requires no tuning. One type, the low-pass filter, passes all frequencies below one critical frequency, and eliminates all higher frequencies. It is this property that makes the device ideal for the task of removing amateur frequencies from broadcast receivers.

A good low-pass filter designed for maximum attenuation around 1700 kc. will pass all broadcast carriers, but will reject signals originating in any amateur band. Naturally such a device should be installed only in standard broadcast receivers, never in all-wave sets.

Two types of low-pass filter sections are shown in figure 20. A composite arrangement comprising a section of each type is more effective than either type operating alone. A composite filter composed of one K-section and one shunt-derived M-section is shown in figure 21, and is highly recommended. The M-section is designed to have maximum attenuation at 1700 kc., and for that reason C_3 should be of the "close tolerance" variety. Likewise, C_3 should not be stuffed down inside L_2 in the interest of compactness, as this will alter the inductance of the coil appreciably, and likewise the resonant frequency.

If a fixed 150 μfd . mica capacitor of 5 per cent tolerance is not available for C_1 , a compression trimmer covering the range of 125–175 μfd . may be substituted and adjusted to give maximum attenuation at about 1700 kc.

19-5 HI-FI Interference

The rapid growth of high-fidelity sound systems in the home has brought about many cases of interference from a nearby amateur transmitter. In most cases, the interference is caused by stray pickup of the r-f signal by the interconnecting leads of the hi-fi system and audio rectification in the low level stages of the amplifier. The solution to this difficulty, in general, is to bypass and filter all speaker and power leads to the hi-fi amplifier and preamplifier. A combination of a VHF choke and 500 μfd ceramic disc capacitors in each power and speaker lead will eliminate r-f pickup in the high level section of the amplifier. A filter such as shown in figure 17A placed in the input circuit of the first audio stage of the preamplifier will reduce the level of the r-f signal reaching the input circuit of the amplifier. To prevent loss of the higher audio frequencies it may be necessary to decrease the value of the grid bypass capacitor to 50 μfd or so.

Shielded leads should be employed between the amplifier and the turntable or f-m tuner. The shield should be grounded at both ends of the line to the chassis of the equipment, and care should be taken to see that the line does not approach an electrical half-wavelength of the radio signal causing the interference. In some instances, shielding the power cable to the hi-fi equipment will aid in reducing interference. The framework of the phonograph turntable should be grounded to the chassis of the amplifier to reduce stray r-f pickup in the turntable equipment.

Transmitter Keying and Control

20-1 Power Systems

It is probable that the average amateur station that has been in operation for a number of years will have at least two transmitters available for operation on different frequency bands, at least two receivers or one receiver and a converter, at least one item of monitoring or frequency measuring equipment and probably two, a v.f.o., a speech amplifier, a desk light, and a clock. In addition to the above 8 or 10 items, there must be an outlet available for a soldering iron and there should be one or two additional outlets available for plugging in one or two pieces of equipment which are being worked upon.

It thus becomes obvious that 10 or 12 outlets connected to the 115-volt a-c line should be available at the operating desk. It may be practicable to have this number of outlets installed as an outlet strip along the baseboard at the time a new home is being planned and constructed. Or it might be well to install the outlet strip on the operating desk so as to have the flexibility of moving the operating desk from one position to another. Alternatively, the outlet strip might be wall mounted just below the desk top.

Power Drain Per Outlet When the power drain of all the items of equipment, other than transmitters, used at the operating position is totalled, you probably will find that 350 to 600 watts will be required.

Since the usual home outlet is designed to handle only about 600 watts maximum, the transmitter, unless it is of relatively low power, should be powered from another source. This procedure is desirable in any event so that the voltage supplied to the receiver, frequency control, and frequency monitor will be substantially constant with the transmitter on or off the air.

So we come to two general alternative plans with their variations. Plan (A) is the more desirable and also the most expensive since it involves the installation of two separate lines from the meter box to the operating position either when the house is constructed or as an alteration. One line, with its switch, is for the transmitters and the other line and switch is for receivers and auxiliary equipment. Plan (B) is the more practicable for the average amateur, but its use requires that all cords be removed from the outlets whenever the station is not in use in order to comply with the electrical codes.

Figure 1 shows a suggested arrangement for carrying out Plan (A). In most cases an installation such as this will require approval of the plans by the city or county electrical inspector. Then the installation itself will also require inspection after it has been completed. It will be necessary to use approved outlet boxes at the rear of the transmitter where the cable is connected, and also at the operating bench where the other BX cable connects to the outlet strip. Also, the connectors at the rear of the transmitter will have to be of an approved

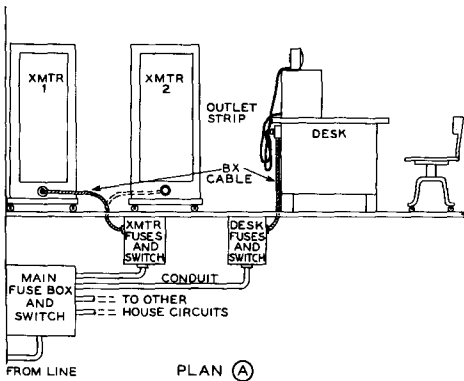

Figure 1

THE PLAN (A) POWER SYSTEM

A-c line power from the main fuse box in the house is run separately to the receiving equipment and to the transmitting equipment. Separate switches and fuse blocks then are available for the transmitters and for the auxiliary equipment. Since the fuses in the boxes at the operating room will be in series with those at the main fuse box, those in the operating room should have a lower rating than those at the main fuse box. Then it will always be possible to replace blown fuses without leaving the operating room. The fuse boxes can conveniently be located alongside one another on the wall of the operating room.

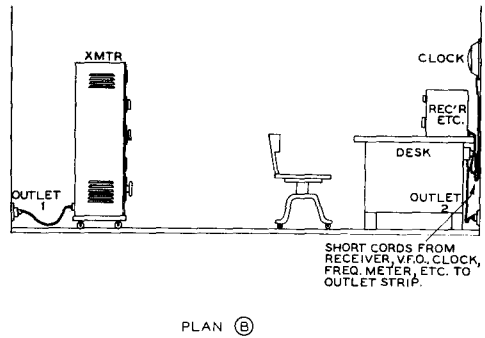

Figure 2

THE PLAN (B) POWER SYSTEM

This system is less convenient than the (A) system, but does not require extensive re-wiring of the electrical system within the house to accommodate the arrangement. Thus it is better for a temporary or semi-permanent installation. In most cases it will be necessary to run an extra conduit from the main fuse box to the outlet from which the transmitter is powered, since the standard arrangement in most houses is to run all the outlets in one room (and sometimes all in the house) from a single pair of fuses and leads.

type. It is possible also that the BX cable will have to be permanently affixed to the transmitter with the connector at the fuse-box end. These details may be worked out in advance with the electrical inspector for your area.

The general aspects of Plan (B) are shown in figure 2. The basic difference between the two plans is that (A) represents a *permanent* installation even though a degree of mobility is allowed through the use of BX for power leads, while plan (B) is definitely a *temporary* type of installation as far as the electrical inspector is concerned. While it will be permissible in most areas to leave the transmitter cord plugged into the outlet even though it is turned off, the Fire Insurance Underwriters codes will make it necessary that the cord which runs to the group of outlets at the back of the operating desk be removed whenever the equipment is not actually in use.

Whether the general aspects of plans (A) or (B) are used it will be necessary to run a number of control wires, keying and audio leads, and an excitation cable from the operating desk

to the transmitter. Control and keying wires can best be grouped into a multiple-wire rubber-covered cable between the desk and the transmitter. Such an arrangement gives a good appearance, and is particularly practical if cable connectors are used at each end. High-level audio at a moderate impedance level (600 ohms or below) may be run in the same control cable as the other leads. However, low-level audio can best be run in a small coaxial cable. Small coaxial cable such as RG-58/U or RG-59/U also is quite satisfactory and quite convenient for the signal from the v.f.o. to the r-f stages in the transmitter. Coaxial-cable connectors of the UG series are quite satisfactory for the terminations both for the v-f-o lead and for any low-level audio cables.

Checking an Outlet with a Heavy Load To make sure that an outlet will stand the full load of the entire transmitter, plug in an electric heater rated at about 50 per cent greater wattage than the power you expect to draw from the line. If the line voltage does

not drop more than 5 volts (assuming a 117-volt line) under load and the wiring does not overheat, the wiring is adequate to supply the transmitter. About 600 watts total drain is the maximum that should be drawn from a 117-volt *lighting* outlet or circuit. For greater power, a separate pair of heavy conductors should be run right from the meter box. For a 1-kw. phone transmitter the total drain is so great that a 230-volt "split" system ordinarily will be required. Most of the newer homes are wired with this system, as are homes utilizing electricity for cooking and heating.

With a three-wire system, be sure there is no fuse in the neutral wire at the fuse box. A neutral fuse is not required if both "hot" legs are fused, and, should a neutral fuse blow, there is a chance that damage to the radio transmitter will result.

If you have a high power transmitter and do a lot of operating, it is a good idea to check on your local power rates if you are on a straight *lighting* rate. In some cities a lower rate can be obtained (but with a higher "minimum") if electrical equipment such as an electric heater drawing a specified amount of current is permanently wired in. It is not required that you use this equipment, merely that it be permanently wired into the electrical system. Naturally, however, there would be no saving unless you expect to occupy the same dwelling for a considerable length of time.

Outlet Strips The *outlet strips* which have been suggested for installation in the baseboard or for use on the rear of a desk are obtainable from the large electrical supply houses. If such a house is not in the vicinity it is probable that a local electrical contractor can order a suitable type of strip from one of the supply house catalogs. These strips are quite convenient in that they are available in varying lengths with provision for inserting a-c line plugs throughout their length. The a-c plugs from the various items of equipment on the operating desk then may be inserted in the outlet strip throughout its length. In many cases it will be desirable to reduce the equipment cord lengths so that they will plug neatly into the outlet strip without an excess to dangle behind the desk.

Contactors and Relays The use of power-control contactors and relays often will add considerably to the operating convenience of the station installation. The most practicable arrangement usually is to have a main a-c line switch on the front of the transmitter to apply power to the filament transformers and to the power control circuits. It also will be found quite convenient to have a single a-c line switch on the operating desk

to energize or cut the power from the outlet strip on the rear of the operating desk. Through the use of such a switch it is not necessary to remember to switch off a large number of separate switches on each of the items of equipment on the operating desk. The alternative arrangement, and that which is approved by the Underwriters, is to remove the plugs from the wall both for the transmitter and for the operating-desk outlet strip when a period of operation has been completed.

While the insertion of plugs or operation of switches usually will be found best for applying the a-c line power to the equipment, the changing over between transmit and receive can best be accomplished through the use of relays. Such a system usually involves three relays, or three groups of relays. The relays and their functions are: (1) power control relay for the transmitter—applies 115-volt line to the primary of the high-voltage transformer and turns on the exciter; (2) control relay for the receiver—makes the receiver inoperative by any one of a number of methods when closed, also may apply power to the v.f.o. and to a keying or a phone monitor; and (3) the antenna changeover relay—connects the antenna to the transmitter when the transmitter is energized and to the receiver when the transmitter is not operating. Several circuits illustrating the application of relays to such control arrangements are discussed in the paragraphs to follow in this chapter.

Controlling Transmitter Power Output It is necessary, in order to comply with FCC regulations, that transmitter power output be limited to the minimum amount necessary to sustain communication. This requirement may be met in several ways. Many amateurs have two transmitters; one is capable of relatively high power output for use when calling, or when interference is severe, and the other is capable of considerably less power output. In many cases the lower powered transmitter acts as the exciter for the higher powered stage when full power output is required. But the majority of the amateurs using a high powered equipment have some provision for reducing the plate voltage on the high-level stages when reduced power output is desired.

One of the most common arrangements for obtaining two levels of power output involves the use of a plate transformer having a double primary for the high-voltage power supply. The majority of the high-power plate transformers of standard manufacture have just such a dual-primary arrangement. The two primaries are designed for use with either a 115-volt or 230-volt line. When such a transformer is to be operated from a 115-volt line, operation of both

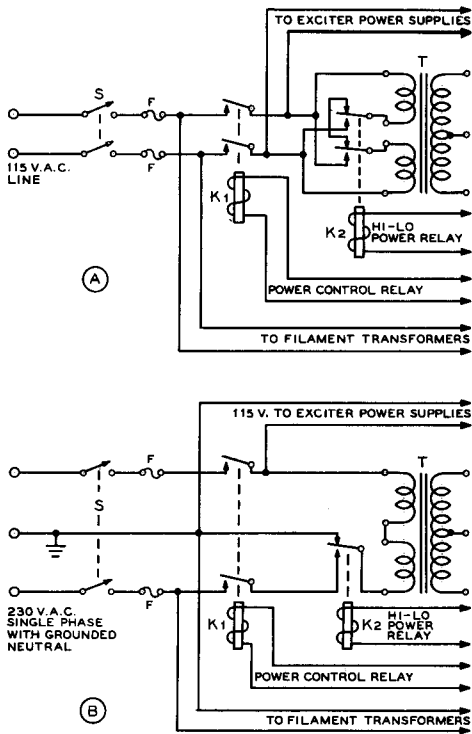

Figure 3

FULL-VOLTAGE/HALF-VOLTAGE POWER CONTROL SYSTEMS

The circuit at (A) is for use with a 115-volt a-c line. Transformer T is of the standard type having two 115-volt primaries; these primaries are connected in series for half-voltage output when the power control relay K_1 is energized but the hi-lo relay K_2 is not operated. When both relays are energized the full output voltage is obtained. At (B) is a circuit for use with a standard 230-volt residence line with grounded neutral. The two relays control the output of the power supplies the same as at (A).

low-voltage power supplies from the other side, and the primaries of the high-voltage transformer across the whole line for full power output. Then when reduced power output is required, the primary of the high-voltage plate transformer is operated from one side to center tap rather than across the whole line. This procedure places 115 volts across the 230-volt winding the same as in the case discussed in the previous paragraph. Figure 3 illustrates the two standard methods of power reduction with a plate transformer having a double primary; (A) shows the connections for use with a 115-volt line and (B) shows the arrangement for a 230-volt a-c power line to the transmitter.

The full-voltage/half-voltage methods for controlling the power input to the transmitter, as just discussed, are subject to the limitation that only two levels of power input (full power and quarter power) are obtainable. In many cases this will be found to be a limitation to flexibility. When tuning the transmitter, the antenna coupling network, or the antenna system itself it is desirable to be able to reduce the power input to the final stage to a relatively low value. And it is further convenient to be able to vary the power input continuously from this relatively low input up to the full power capabilities of the transmitter. The use of a variable-ratio auto-transformer in the circuit from the line to the primary of the plate transformer will allow a continuous variation in power input from zero to the full capability of the transmitter.

Variable-Ratio Auto-Transformers There are several types of variable-ratio auto-transformers available on the market. Of these, the most common are the *Variac* manufactured by the General Radio Company, and the *Powerstat* manufactured by the Superior Electric Company. Both these types of variable-ratio transformers are excellently constructed and are available in a wide range of power capabilities. Each is capable of controlling the line voltage from zero to about 15 per cent above the nominal line voltage. Each manufacturer makes a single-phase unit capable of handling an output power of about 175 watts, one capable of about 750 to 800 watts, and a unit capable of about 1500 to 1800 watts. The maximum power-output capability of these units is available only at approximately the nominal line voltage, and must be reduced to a maximum current limitation when the output voltage is somewhat above or below the input line voltage. This, however, is not an important limitation for this type of application since the output voltage seldom will be raised above the line voltage, and when the output voltage is reduced below the line voltage the input to the transmitter is reduced accordingly.

primaries in parallel will deliver full output from the plate supply. Then when the two primaries are connected in series and still operated from the 115-volt line the output voltage from the supply will be reduced approximately to one half. In the case of the normal class C amplifier, a reduction in plate voltage to one half will reduce the power input to the stage to one quarter.

If the transmitter is to be operated from a 230-volt line, the usual procedure is to operate the filaments from one side of the line, the

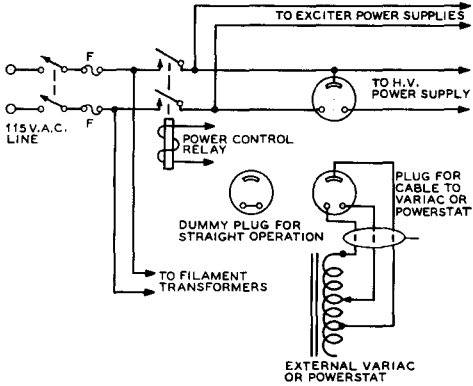

Figure 4
CIRCUIT WITH VARIABLE-RATIO AUTO-TRANSFORMER

When the dummy plug is inserted into the receptacle on the equipment, closing of the power control relay will apply full voltage to the primaries. With the cable from the Variac or Powerstat plugged into the socket the voltage output of the high-voltage power supply may be varied from zero to about 15 per cent above normal.

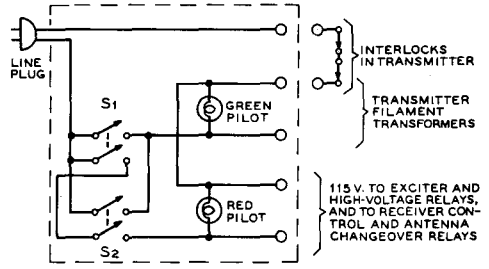

Figure 5
PROTECTIVE CONTROL CIRCUIT

With this circuit arrangement either switch may be closed first to light the heaters of all tubes and the filament pilot light. Then when the second switch is closed the high voltage will be applied to the transmitter and the red pilot will light. With a 30-second delay between the closing of the first switch and the closing of the second, the rectifier tubes will be adequately protected. Similarly, the opening of either switch will remove plate voltage from the rectifiers while the heaters remain lighted.

One convenient arrangement for using a Variac or Powerstat in conjunction with the high-voltage transformer of a transmitter is illustrated in figure 4. In this circuit a heavy three-wire cable is run from a plug on the transmitter to the Variac or Powerstat. The Variac or Powerstat then is installed so that it is accessible from the operating desk so that the input power to the transmitter may be controlled during operation. If desired, the cable to the Variac or Powerstat may be unplugged from the transmitter and a dummy plug inserted in its place. With the dummy plug in place the transmitter will operate at normal plate voltage. This arrangement allows the transmitter to be wired in such a manner that an external Variac or Powerstat may be used if desired, even though the unit is not available at the time that the transmitter is constructed.

Notes on the Use of the Variac or Powerstat Plate voltage to the modulators may be controlled at the same time as the plate voltage to the final amplifier is varied if the modulator stage uses beam tetrode tubes; variation in the plate voltage on such tubes used as modulators causes only a moderate change in the standing plate current. Since the final amplifier plate voltage is being controlled simultaneously with the modulator

plate voltage, the conditions of impedance match will not be seriously upset. In several high power transmitters using this system, and using beam-tetrode modulator tubes, it is possible to vary the plate input from about 50 watts to one kilowatt without a change other than a slight increase in audio distortion at the adjustment which gives the lowest power output from the transmitter.

With triode tubes as modulators it usually will be found necessary to vary the grid bias at the same time that the plate voltage is changed. This will allow the tubes to be operated at approximately the same relative point on their operating characteristic when the plate voltage is varied. When the modulator tubes are operated with zero bias at full plate voltage, it will usually be possible to reduce the modulator voltage along with the voltage on the modulated stage, with no apparent change in the voice quality. However, it will be necessary to reduce the audio gain at the same time that the plate voltage is reduced.

20-2 Transmitter Control Methods

Almost everyone, when getting a new trans-

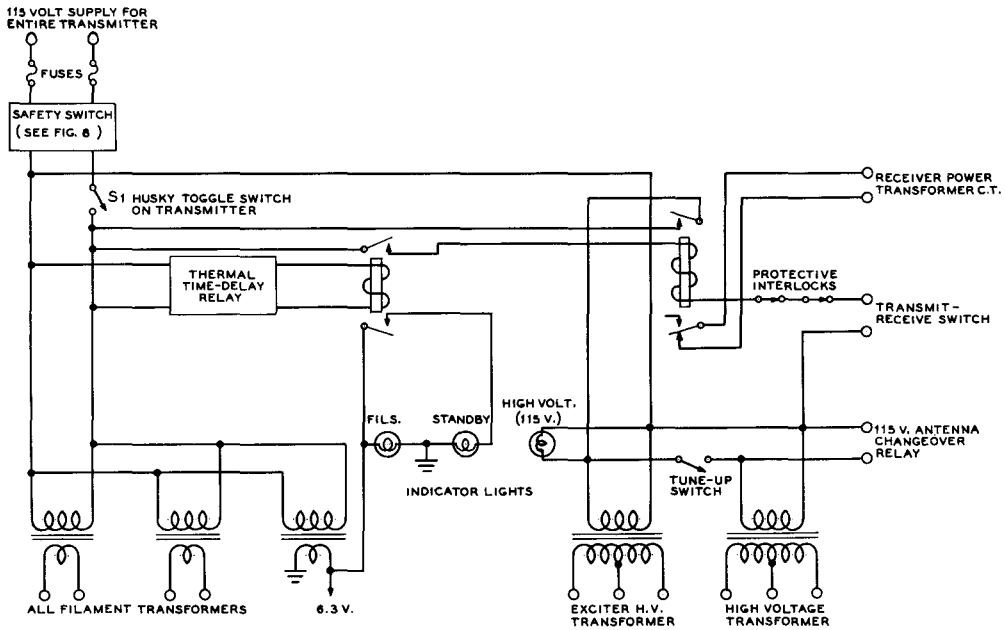

Figure 6
TRANSMITTER CONTROL CIRCUIT

Closing S_1 lights all filaments in the transmitter and starts the time-delay relay in its cycle. When the time-delay relay has operated, closing the transmit-receive switch at the operating position will apply plate power to the transmitter and disable the receiver. A tune-up switch has been provided so that the exciter stages may be tuned without plate voltage on the final amplifier.

mitter on the air, has had the experience of having to throw several switches and pull or insert a few plugs when changing from receive to transmit. This is one extreme in the direction of how *not* to control a transmitter. At the other extreme we find systems where it is only necessary to speak into the microphone or touch the key to change both transmitter and receiver over to the transmit condition. Most amateur stations are intermediate between the two extremes in the control provisions and use some relatively simple system for transmitter control.

In figure 5 is shown an arrangement which protects mercury-vapor rectifiers against premature application of plate voltage without resorting to a time-delay relay. No matter which switch is thrown first, the filaments will be turned on first and off last. However, double-pole switches are required in place of the usual single-pole switches.

When assured time delay of the proper interval and greater operating convenience are desired, a group of inexpensive a-c relays may

be incorporated into the circuit to give a control circuit such as is shown in figure 6. This arrangement uses a 115-volt thermal (or motor-operated) time-delay relay and a d-p-d-t 115-volt control relay. Note that the protective interlocks are connected in series with the coil of the relay which applies high voltage to the transmitter. A tune-up switch has been included so that the transmitter may be tuned up as far as the grid circuit of the final stage is concerned before application of high voltage to the final amplifier. Provisions for operating an antenna-changeover relay and for cutting the plate voltage to the receiver when the transmitter is operating have been included.

A circuit similar to that of figure 6 but incorporating push-button control of the transmitter is shown in figure 7. The circuit features a set of START-STOP and TRANSMIT-RECEIVE buttons at the transmitter and a separate set at the operating position. The control push buttons operate independently so that either set may be used to control the transmitter. It is only necessary to push the START

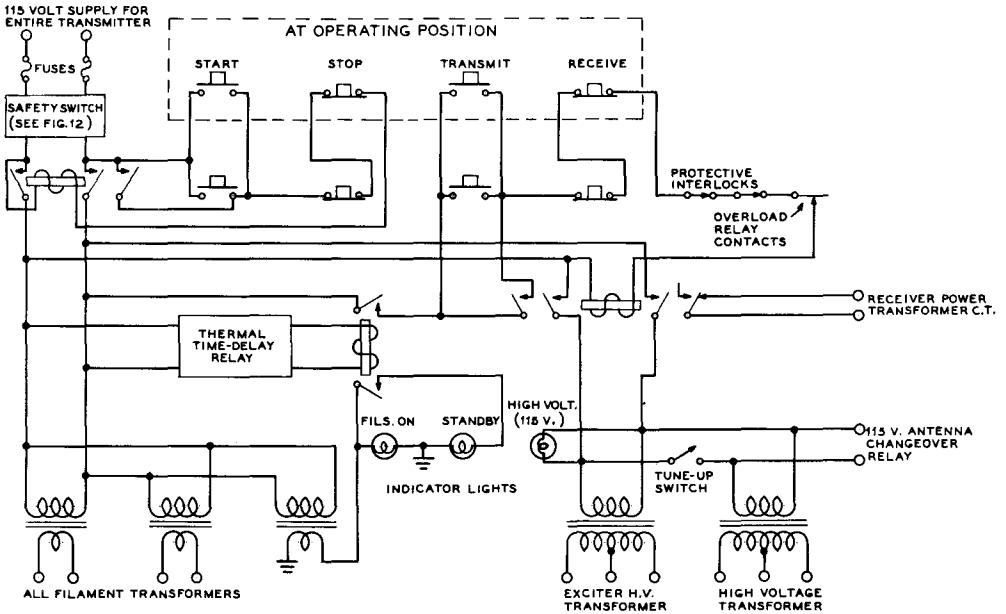

Figure 7
PUSH-BUTTON TRANSMITTER-CONTROL CIRCUIT

Pushing the **START** button either at the transmitter or at the operating position will light all filaments and start the time-delay relay in its cycle. When the cycle has been completed, a touch of the **TRANSMIT** button will put the transmitter on the air and disable the receiver. Pushing the **RECEIVE** button will disable the transmitter and restore the receiver. Pushing the **STOP** button will instantly drop the entire transmitter from the a-c line. If desired, a switch may be placed in series with the lead from the **RECEIVE** button to the protective interlocks; opening the switch will make it impossible for any person accidentally to put the transmitter on the air. Various other safety provisions, such as the protective-interlock arrangement described in the text have been incorporated.

With the circuit arrangement shown for the overload-relay contacts, it is only necessary to use a simple normally-closed d-c relay with a variable shunt across the coil of the relay. When the current through the coil becomes great enough to open the normally-closed contacts the hold-circuit on the plate-voltage relay will be broken and the plate voltage will be removed. If the overload is only momentary, such as a modulation peak or a tank flashover, merely pushing the **TRANSMIT** button will again put the transmitter on the air. This simple circuit provision eliminates the requirement for expensive overload relays of the mechanically-latching type, but still gives excellent overload protection.

button momentarily to light the transmitter filaments and start the time-delay relay in its cycle. When the standby light comes on it is only necessary to touch the **TRANSMIT** button to put the transmitter on the air and disable the receiver. Touching the **RECEIVE** button will turn off the transmitter and restore the receiver. After a period of operation it is only necessary to touch the **STOP** button at either the transmitter or the operating position to shut down the transmitter. This type of control arrangement is called an electrically-locking push-to-

transmit control system. Such systems are frequently used in industrial electronic control.

20-3 Safety Precautions

The best way for an operator to avoid serious accidents from the high voltage supplies of a transmitter is for him to use his head, act only with deliberation, and not take unneces-

sary chances. However, no one is infallible, and chances of an accident are greatly lessened if certain factors are taken into consideration in the design of a transmitter, in order to protect the operator in the event of a lapse of caution. If there are too many things one must "watch out for" or keep in mind there is a good chance that sooner or later there will be a mishap; and it only takes *one*. When designing or constructing a transmitter, the following safety considerations should be given attention.

Grounds For the utmost in protection, everything of metal on the front panel of a transmitter capable of being touched by the operator should be at ground potential. This includes dial set screws, meter zero adjuster screws, meter cases if of metal, meter jacks, *everything* of metal protruding through the front panel or capable of being touched or *nearly* touched by the operator. This applies whether or not the panel itself is of metal. Do not rely upon the insulation of meter cases or tuning knobs for protection.

The B negative or chassis of all plate power supplies should be connected together, and to an external ground such as a waterpipe.

Exposed Wires and Components It is not necessary to resort to rack and panel construction in order to provide complete enclosure of all components and wiring of the transmitter. Even with metal-chassis construction it is possible to arrange things so as to incorporate a protective shielding housing which will not interfere with ventilation yet will prevent contact with all wires and components carrying high voltage d.c. or a.c., in addition to offering shielding action.

If everything on the front panel is at ground potential (with respect to external ground) and all units are effectively housed with protective covers, then there is no danger except when the operator must reach into the interior part of the transmitter, as when changing coils, neutralizing, adjusting coupling, or shooting trouble. The latter procedure can be made safe by making it possible for the operator to be *absolutely certain* that all voltages have been turned off and that they cannot be turned on either by short circuit or accident. This can be done by incorporation of the following system of main primary switch and safety signal lights.

Combined Safety Signal and Switch The common method of using red pilot lights to show when a circuit is on is useless except from an ornamental standpoint. When the red pilot is not lit it *usually* means that the circuit is turned off, but it *can*

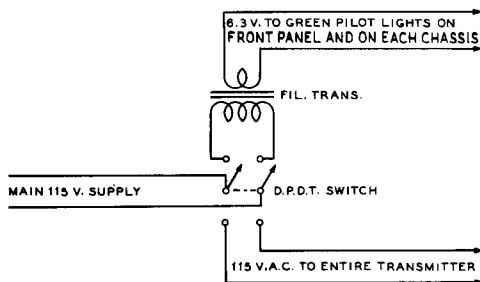

Figure 8
COMBINED MAIN SWITCH AND
SAFETY SIGNAL

When shutting down the transmitter, throw the main switch to neutral. If work is to be done on the transmitter, throw the switch all the way to "pilot," thus turning on the green pilot lights on the panel and on each chassis, and insuring that no voltage can exist on the primary of any transformer, even by virtue of a short or accidental ground.

mean that the circuit is on but the lamp is burned out or not making contact.

To enable you to touch the tank coils in your transmitter with absolute assurance that it is impossible for you to obtain a shock except from possible undischarged filter condensers (see following topic for elimination of this hazard), it is only necessary to incorporate a device similar to that of figure 8. It is placed near the point where the main 110-volt leads enter the room (preferably near the door) and in such a position as to be inaccessible to small children. Notice that this switch breaks *both* leads; switches that open just one lead do not afford complete protection, as it is sometimes possible to complete a primary circuit through a short or accidental ground. Breaking just one side of the line may be all right for turning the transmitter on and off, but when you are going to place an arm inside the transmitter, *both* 110-volt leads should be broken.

When you are all through working your transmitter for the time being, simply throw the main switch to neutral.

When you find it necessary to work on the transmitter or change coils, throw the switch so that the green pilots light up. These can be ordinary 6.3-volt pilot lamps behind green bezels or dipped in green lacquer. One should be placed on the front panel of the transmitter; others should be placed so as to be easily visible when changing coils or making adjustments requiring the operator to reach inside the transmitter.

For 100 per cent protection, just obey the following rule: *never work on the transmitter or reach inside any protective cover except when the green pilots are glowing.* To avoid confusion, no other green pilots should be used on the transmitter; if you want an indicator jewel to show when the filaments are lighted, use amber instead of green.

Safety Bleeders Filter capacitors of good quality hold their charge for some time, and when the voltage is more than 1000 volts it is just about as dangerous to get across an undischarged 4- μ f. filter capacitor as it is to get across a high-voltage supply that is turned on. Most power supplies incorporate bleeders to improve regulation, but as these are generally wire-wound resistors, and as wire-wound resistors occasionally open up without apparent cause, it is desirable to incorporate an auxiliary safety bleeder across each heavy-duty bleeder. Carbon resistors will not stand much dissipation and sometimes change in value slightly with age. However, the chance of their opening up when run well within their dissipation rating is very small.

To make sure that all capacitors are bled, it is best to short each one with an insulated screwdriver. However, this is sometimes awkward and always inconvenient. One can be virtually sure by connecting auxiliary carbon bleeders across all wire-wound bleeders used on supplies of 1000 volts or more. For every 500 volts, connect in series a 500,000-ohm 1-watt carbon resistor. The drain will be negligible (1 ma.) and each resistor will have to dissipate only 0.5 watt. Under these conditions the resistors will last indefinitely with little chance of opening up. For a 1500-volt supply, connect three 500,000-ohm resistors in series. If the voltage exceeds an integral number of 500 volt divisions, assume it is the next higher integral value; for instance, assume 1800 volts as 2000 volts and use four resistors.

Do *not* attempt to use fewer resistors by using a higher value for the resistors; not over 500 volts should appear across any single 1-watt resistor.

In the event that the regular bleeder opens up, it will take several seconds for the auxiliary bleeder to drain the capacitors down to a safe voltage, because of the very high resistance. Therefore, it is best to allow 10 or 15 seconds after turning off the plate supply before attempting to work on the transmitter.

If a 0-1 d-c milliammeter is at hand, it may be connected in series with the auxiliary bleeder to act as a high voltage voltmeter.

"Hot" Adjustments Some amateurs contend that it is almost impossible

to make certain adjustments, such as coupling and neutralizing, unless the transmitter is running. The best thing to do is to make all neutralizing and coupling devices adjustable from the front panel by means of flexible control shafts which are broken with insulated couplings to permit grounding of the panel bearing.

If your particular transmitter layout is such that this is impracticable and you refuse to throw the main switch to make an adjustment—throw the main switch—take a reading—throw the main switch—make an adjustment—and so on, then protect yourself by making use of long adjusting rods made from $\frac{1}{2}$ -inch dowel sticks which have been wiped with oil when perfectly free from moisture.

If you are addicted to the use of pickup loop and flashlight bulb as a resonance and neutralizing indicator, then fasten it to the end of a long dowel stick and use it in that manner.

Protective Interlocks With the increasing tendency toward construction of transmitters in enclosed steel cabinets a transmitter becomes a particularly lethal device unless adequate safety provisions have been incorporated. Even with a combined safety signal and switch as shown in figure 8 it is still conceivable that some person unfamiliar with the transmitter could come in contact with high voltage. It is therefore recommended that the transmitter, wherever possible, be built into a complete metal housing or cabinet and that all doors or access covers be provided with protective interlocks (all interlocks must be connected in *series*) to remove the high voltage whenever these doors or covers are opened. The term "high voltage" should mean any voltage above approximately 150 volts, although it is still possible to obtain a serious burn from a 150-volt circuit under certain circumstances. The 150-volt limit usually will mean that grid-bias packs as well as high-voltage packs should have their primary circuits opened when any interlock is opened.

20-4 Transmitter Keying

The carrier from a c-w telegraph transmitter must be broken into dots and dashes for the transmission of code characters. The carrier signal is of constant amplitude while the key is closed, and is entirely removed when the key is open. When code characters are being transmitted, the carrier may be considered as being modulated by the keying. If the change from the no-output condition to full-output, or vice versa, occurs too rapidly, the rectangular pulses which form the keying characters contain high-frequency components which take up

a wide frequency band as sidebands and are heard as clicks.

The cure for transient key clicks is relatively simple, although one would not believe it, judging from the hordes of clicky, "snappy" signals heard on the air.

To be capable of transmitting code characters and at the same time not splitting the eardrums of neighboring amateurs, the c-w transmitter MUST meet two important specifications.

- 1- It must have no parasitic oscillations either in the stage being keyed or in any succeeding stage.
- 2- It must have some device in the keying circuit capable of shaping the leading and trailing edge of the waveform.

Both these specifications must be met before the transmitter is capable of c-w operation. Merely turning a transmitter on and off by the haphazard insertion of a telegraph key in some power lead is an invitation to trouble.

The two general methods of keying a transmitter are those which control the excitation to the keyed amplifier, and those which control the plate or screen voltage applied to the keyed amplifier.

Key-Click Elimination Key-click elimination is accomplished by preventing a too-rapid make-and-break of power to the antenna circuit, rounding off the keying characters so as to limit the sidebands to a value which does not cause interference to adjacent channels. Too much lag will prevent fast keying, but fortunately key clicks can be practically eliminated without limiting the speed of manual (hand) keying. Some circuits which eliminate key clicks introduce too much time-lag and thereby add *tails* to the dots. These tails may cause the signals to be difficult to copy at high speeds.

Location of Keyed Stage Considerable thought should be given as to which stage in a transmitter is the proper one to key. If the transmitter is keyed in a stage close to the oscillator, the change in r-f loading of the oscillator will cause the oscillator to shift frequency with keying. This will cause the signal to have a distinct chirp. The chirp will be multiplied as many times as the frequency of the oscillator is multiplied. A chirpy oscillator that would be passable on 80 meters would be unusable on 28 Mc. c.w.

Keying the oscillator itself is an excellent way to run into keying difficulties. If no key click filter is used in the keying circuit, the transmitter will have bad key clicks. If a key click filter is used, the slow rise and decay of oscillator voltage induced by the filter action will cause a keying chirp. This action is

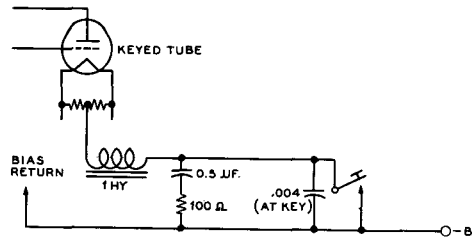

Figure 9
CENTER-TAP KEYING WITH CLICK
FILTER

The constants shown above are suggested as starting values; considerable variation in these values can be expected for optimum keying of amplifiers of different operating conditions. It is suggested that a keying relay be substituted for the key in the circuit above wherever practicable.

true of all oscillators, whether electron coupled or crystal controlled.

The more amplifier or doubler stages that follow the keyed stage, the more difficult it is to hold control of the shape of the keyed waveform. A heavily excited doubler stage or class C stage acts as a peak clipper, tending to square up a rounded keying impulse, and the cumulative effect of several such stages cascaded is sufficient to square up the keyed waveform to the point where bad clicks are reimposed on a clean signal.

A good rule of thumb is to never key back farther than one stage removed from the final amplifier stage, and never key closer than one stage removed from the frequency controlling oscillator of the transmitter. Thus there will always be one isolating stage between the keyed stage and the oscillator, and one isolating stage between the keyed stage and the antenna. At this point the waveform of the keyed signal may be most easily controlled.

Keyer Circuit Requirements In the first place it may be established that the majority of new design transmitters, and many of those of older design as well, use a medium power beam tetrode tube either as the output stage or as the exciter for the output stage of a high power transmitter. Thus the transmitter usually will end up with a tube such as type 2E26, 807, 6146, 813, 4-65A, 4E27/257B, 4-125A or similar, or one of these tubes will be used as the stage just ahead of the output stage.

Second, it may be established that it is undesirable to key further down in the transmitter chain than the stage just ahead of the final

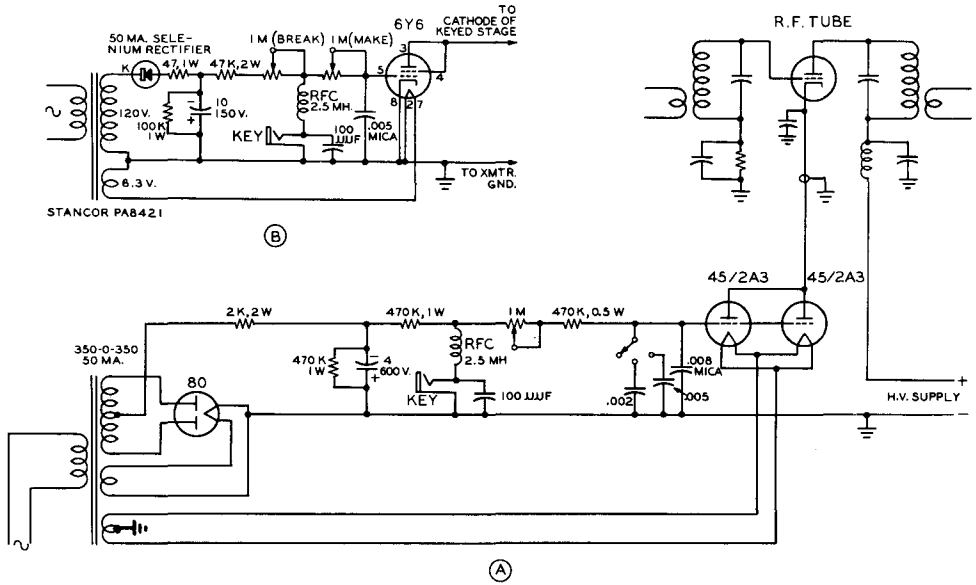

Figure 10
VACUUM TUBE KEYERS FOR CENTER-TAP KEYING CIRCUITS

The type A keyer is suitable for keying stages running up to 1250 volts on the plate. Two 2A3 or 6A3 tubes can safely key 160 milliamperes of cathode current. The simple 6Y6 keyer in figure B is for keying stages running up to 650 volts on the plate. A single 6Y6 can key 80 milliamperes. Two in parallel may be used for plate currents under 160 ma. If softer keying is desired, the 500-μfd. mica condenser should be increased to .001 μfd.

amplifier. If a low-level stage, which is followed by a series of class C amplifiers, is keyed, serious transients will be generated in the output of the transmitter even though the keyed stage is being turned on and off very smoothly. This condition arises as a result of *pulse sharpening*, which has been discussed previously.

Third, the output from the stage should be completely cut off when the key is up, and the time constant of the rise and decay of the keying wave should be easily controllable.

Fourth, it should be possible to make the rise period and the decay period of the keying wave approximately equal. This type of keying envelope is the only one tolerable for commercial work, and is equally desirable for obtaining clean cut and easily readable signals in amateur work.

Fifth, it is desirable that the keying circuit be usable without a keying relay, even when a high-power stage is being keyed.

Last, for the sake of simplicity and safety, it should be possible to ground the frame of the key, and yet the circuit should be such

that placing the fingers across the key will not result in an electrical shock. In other words, the keying circuit should be inherently safe.

All these requirements have been met in the keying circuits to be described.

20-5 Cathode Keying

The lead from the cathode or center-tap connection of the filament of an r-f amplifier can be opened and closed for a keying circuit. Such a keying system opens the plate voltage circuit and at the same time opens the grid bias return lead. For this reason, the grid circuit is blocked at the same time the plate circuit is opened. This helps to reduce the backwave that might otherwise leak through the keyed stage.

The simplest cathode keying circuit is illustrated in figure 9, where a key-click filter is employed, and a hand key is used to break the circuit. This simple keying circuit is not

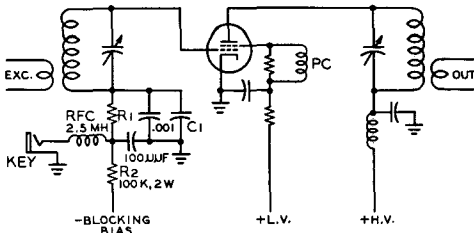

Figure 11
SIMPLE BLOCKED-GRID KEYING SYSTEM

The blocking bias must be sufficient to cut-off plate current to the amplifier stage in the presence of the excitation voltage. R_1 is normal bias resistor for the tube. R_2 and C_1 should be adjusted for correct keying waveform.

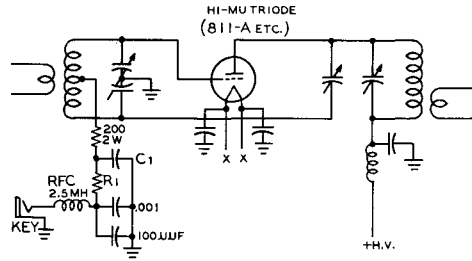

Figure 12
SELF-BLOCKING KEYING SYSTEM FOR HIGH-MU TRIODE

R_1 and C_1 adjusted for correct keying waveform. R_1 is bias resistor of tube.

recommended for general use, as considerable voltage will be developed across the key when it is open.

An electronic switch can take the place of the hand key. This will remove the danger of shock. At the same time, the opening and closing characteristics of the electronic switch may easily be altered to suit the particular need at hand. Such an electronic switch is called a *vacuum tube keyer*. Low internal resistance triode tubes such as the 45, 6A3, or 6AS7 are used in the keyer. These tubes act as a very high resistance when sufficient

blocking bias is applied to them, and as a very low resistance when the bias is removed. The desired amount of lag or *cushioning effect* can be obtained by employing suitable resistance and capacitance values in the grid of the keyer tube(s). Because very little spark is produced at the key, due to the small amount of power in the key circuit, sparking clicks are easily suppressed.

One type 45 tube should be used for every 50 ma. of plate current. Type 6B4G or 2A3 tubes may also be used; allow one 6B4G tube for every 80 ma. of plate current.

Because of the series resistance of the keyer tubes, the plate voltage at the keyed tube will be from 30 to 60 volts less than the power supply voltage. This voltage appears as cathode bias on the keyed tube, assuming the bias return is made to ground, and should be taken into consideration when providing bias.

Some typical cathode circuit vacuum tube keying units are shown in figure 10.

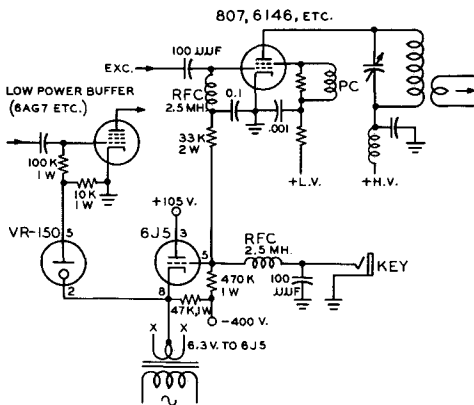

Figure 13
TWO-STAGE BLOCKED-GRID KEYER
A separate filament transformer must be used for the 6J5, as its filament is at a potential of -400 volts.

20-6 Grid Circuit Keying

Grid circuit, or blocked grid keying is another effective method of keying a c-w transmitter. A basic blocked grid keying circuit is shown in figure 11. The time constant of the keying is determined by the RC circuit, which also forms part of the bias circuit of the tube. When the key is closed, operating bias is developed by the flow of grid current through R_1 . When the key is open, sufficient fixed bias is applied to the tube to block it, preventing the stage from functioning. If an un-neutralized

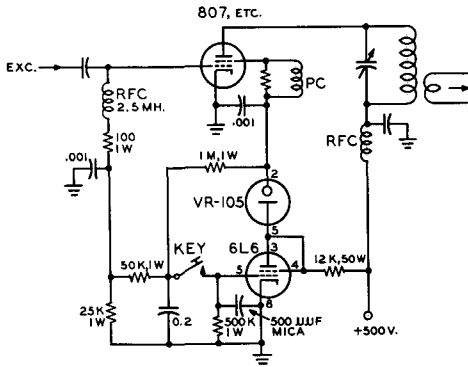

Figure 14
SINGLE-STAGE SCREEN GRID KEYS
FOR TETRODE TUBES

tetrode is keyed by this method, there is the possibility of a considerable backwave caused by r-f leakage through the grid-plate capacity of the tube.

Certain hi- μ triode tubes, such as the 811-A and the 805, automatically block themselves when the grid return circuit is opened. It is merely necessary to insert a key and associated key click filter in the grid return lead of these tubes. No blocking bias supply is needed. This circuit is shown in figure 12.

A more elaborate blocked-grid keying system has been developed by WIDX, and was shown in the February, 1954 issue of QST magazine. This highly recommended circuit is shown in figure 13. Two stages are keyed,

preventing any backwave emission. The first keyed stage may be the oscillator, or a low powered buffer. The last keyed stage may be the driver stage to the power amplifier, or the amplifier itself. Since the circuit is so proportioned that the lower powered stage comes on *first* and goes off *last*, any keying chirp in the oscillator is not emitted on the air. Keying lag is applied to the high powered keyed stage only.

20-7 Screen Grid Keying

The screen circuit of a tetrode tube may be keyed for c-w operation. Unfortunately, when the screen grid of a tetrode tube is brought to zero potential, the tube still delivers considerable output. Thus it is necessary to place a negative blocking voltage on the screen grid to reduce the backwave through the tube. A suitable keyer circuit that will achieve this was developed by W6DTY, and was described in the February, 1953 issue of CQ magazine. This circuit is shown in figure 14. A 6L6 is used as a combined clamper tube and keying tube. When the key is closed, the 6L6 tube has blocking bias applied to its control grid. This bias is obtained from the rectified grid bias of the keyed tube. Screen voltage is applied to the keyed stage through a screen dropping resistor and a VR-105 regulator tube. When the key is open, the 6L6 is no longer cut-off, and conducts heavily. The voltage drop across the dropping resistor caused by the heavy plate current of the 6L6 lowers the voltage on the VR-105 tube until it is extin-

Figure 15
TOP VIEW OF SCREEN
GRID KEYS SHOWN IN
FIGURE 16

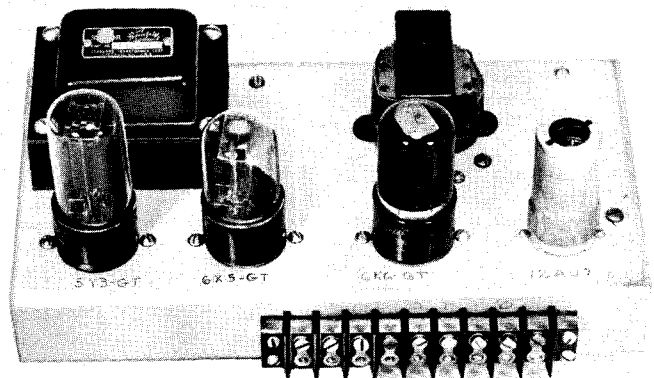

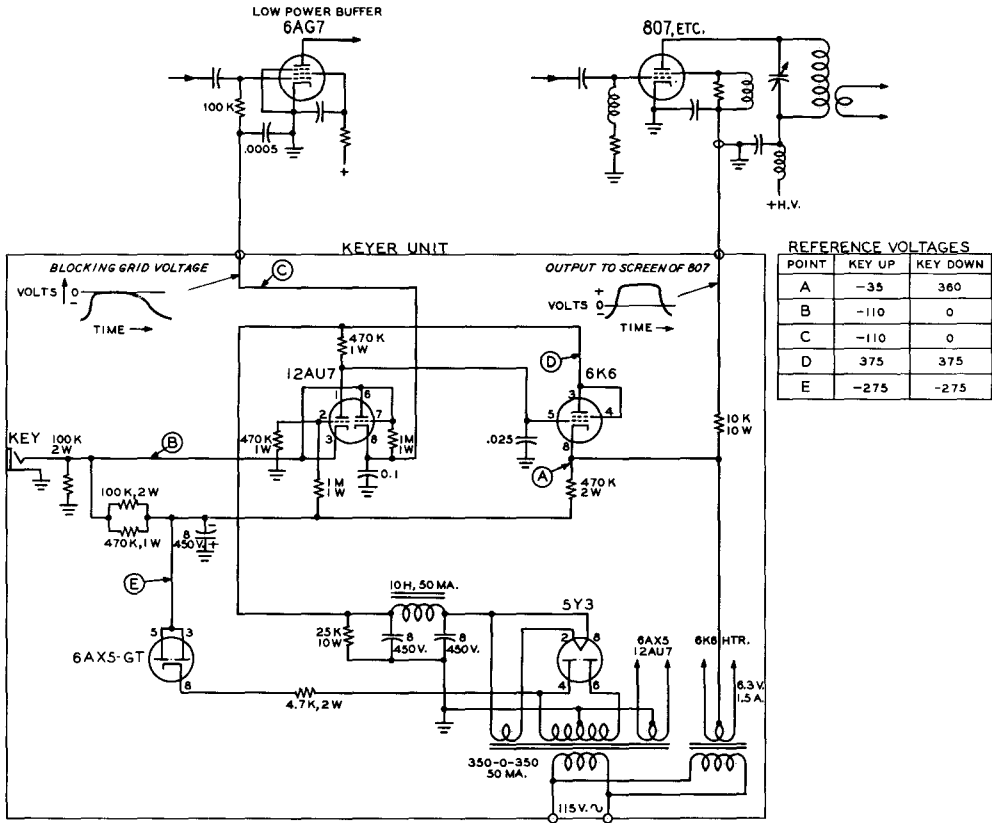

Figure 16
TWO-STAGE SCREEN GRID KEYER UNIT

guished, removing the screen voltage from the tetrode r-f tube. At the same time, rectified grid bias is applied to the screen of the tetrode through the 1 megohm resistor between screen and key. This voltage effectively cuts off the screen of the tetrode until the key is closed again. The RC circuit in the grid of the 6L6 tube determines the keying characteristic of the tetrode tube.

A more elaborate screen grid keyer is shown in figures 15 and 16. This keyer is designed to block-grid key the oscillator or a low powered buffer stage, and to screen key a medium powered tetrode tube such as an 807, 2E26 or 6146. The unit described includes a simple dual voltage power supply for the positive screen voltage of the tetrode, and a negative supply for the keyer stages. A 6K6 is used as the screen keyer, and a 12AU7 is used as a cathode follower and grid block keyer. As in

the WIDX keyer, this keyer turns on the exciter a moment before the tetrode stage is turned on. The tetrode stage goes off an instant before the exciter does. Thus any keying chirp of the oscillator is effectively removed from the keyed signal.

By listening in the receiver one can hear the exciter stop operating a fraction of a second after the tetrode stage goes off. In fact, during rapid keying, the exciter may be heard as a steady signal in the receiver, as it has appreciable time lag in the keying circuit. The clipping effect of following stages has a definite hardening effect on this, however.

20-8 Differential Keying Circuits

Excellent waveshaping may be obtained by a *differential keying* system whereby the master oscillator of the transmitter is turned

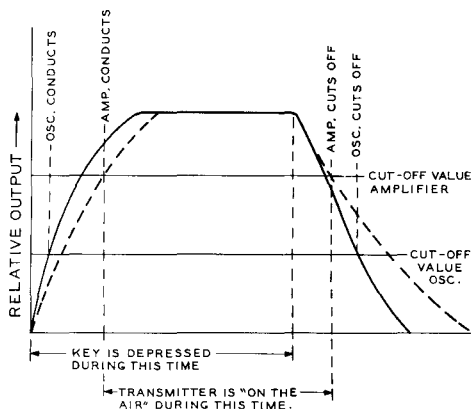

Figure 17

TIME SEQUENCE OF A DIFFERENTIAL KEYSER

on a moment before the rest of the stages are energized, and remains on a moment longer than the other stages. The "chirp" or frequency shift associated with abrupt switching of the oscillator is thus removed from the emitted signal. In addition, the differential keyer can apply waveshaping to the amplifier section of the transmitter, eliminating the "click" caused by rapid keying of the latter stages.

The ideal keying system would perform as illustrated in figure 17. When the key is closed, the oscillator reaches maximum output almost instantaneously. The following stages reach maximum output in a fashion determined by the waveshaping circuits of the keyer. When the key is released, the output of the amplifier stages starts to decay in a predetermined manner, followed shortly thereafter by cessation of the oscillator. The overall result of these actions is to provide relatively soft "make" and "break" to the keyed signal, meanwhile preventing oscillator frequency shift during the keying sequence.

The rates of charge and decay in a typical R-C keying circuit may be varied independently of each other by the blocking diode system of figure 18. Each diode permits the charging current of the timing capacitor to flow through only one of the two variable potentiometers, thus permitting independent adjustment of the "make" and "break" characteristics of the keying system.

A practical differential keying system de-

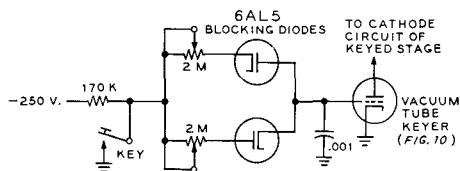

Figure 18

BLOCKING DIODES EMPLOYED TO VARY TIME CONSTANT OF "MAKE" AND "BREAK" CHARACTERISTICS OF VACUUM TUBE KEYSER

veloped by WIICP (Feb., 1956 *QST*) is shown in figure 19. A 6AL5 switch tube turns the oscillator on before the keying action starts, and holds it on until after the keying sequence is completed. Time constant of the keying cycle is determined by values of C and R. When the key is open, a cut-off bias of about -110 volts is applied to the screen grid circuits of the keyed stages. When the key is closed, the screen grid voltage rises to the normal value at a rate determined by the time constant R-C. Upon opening the key again, the screen voltage returns to cut-off value at the predetermined rate.

The potentiometer R1 serves as an output control, varying the minimum internal resistance of the 12BH7 keyer tube, and is a useful device to limit power input during tune-up periods. Excitation to the final amplifier stage may be controlled by the screen potentiometer R3 in the second buffer stage. An external bias source of approximately -120 volts at 10 milliamperes is required for operation of the keyer, in addition to the 300-volt screen supply.

Blocking voltage may be removed from the oscillator for "zeroing" purposes by closing switch S1, rendering the diode switch inoperative.

A second popular keying system is shown in figure 20, and is widely used in many *Johnson* transmitters. Grid block keying is used on tubes V2 and V3. A waveshaping filter consisting of R2, R3, and C1 is used in the keying control circuit of V2 and V3. To avoid chirp when the oscillator (V1) is keyed, the keyer tube V4 allows the oscillator to start quickly—before V2 and V3 start

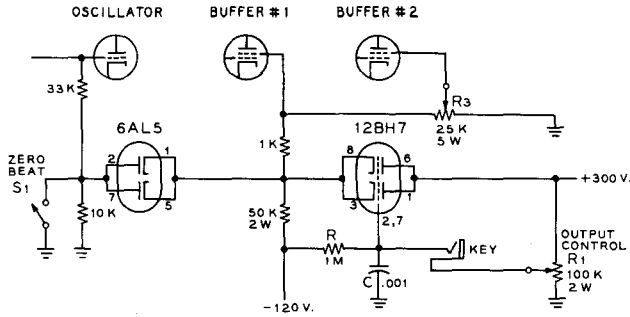

Figure 19
DIFFERENTIAL KEYING SYSTEM WITH
OSCILLATOR SWITCHING DIODE

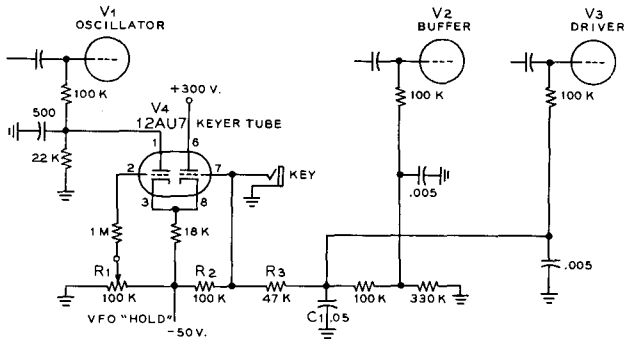

Figure 20
DIFFERENTIAL KEYER EMPLOYED IN
"JOHNSON" TRANSMITTERS

conducting—and then continue operating until after V2 and V3 have stopped conducting. Potentiometer R1 adjusts the "hold" time for VFO operation after the key is opened.

This may be adjusted to cut off the VFO between marks of keyed characters, thus allowing rapid break-in operation.

Radiation, Propagation and Transmission Lines

Radio waves are electromagnetic waves similar in nature but much lower in frequency than light waves or heat waves. Such waves represent electric energy traveling through space. Radio waves travel in free space with the velocity of light and can be reflected and refracted much the same as light waves.

21-1 Radiation from an Antenna

Alternating current passing through a conductor creates an alternating electromagnetic field around that conductor. Energy is alternately stored in the field, and then returned to the conductor. As the frequency is raised, more and more of the energy does not return to the conductor, but instead is radiated off into space in the form of electromagnetic waves, called radio waves. Radiation from a wire, or wires, is materially increased whenever there is a sudden *change* in the *electrical constants* of the line. These sudden changes produce reflection, which places *standing waves* on the line.

When a wire in space is fed radio frequency energy having a wavelength of approximately 2.1 times the length of the wire in meters, the wire *resonates* as a *half-wave dipole* antenna at that wavelength or frequency. The greatest

possible change in the electrical constants of a line is that which occurs at the open end of a wire. Therefore, a dipole has a great mismatch at each end, producing a high degree of reflection. We say that the ends of a dipole are terminated in an infinite impedance.

A returning wave which has been reflected meets the next incident wave, and the voltage and current at any point along the antenna are the vector sum of the two waves. At the ends of the dipole, the voltages add, while the currents of the two waves cancel, thus producing *high voltage* and *low current* at the *ends* of the dipole or half wave section of wire. In the same manner, it is found that the currents add while the voltages cancel at the center of the dipole. Thus, at the *center* there is *high current* but *low voltage*.

Inspection of figure 1 will show that the current in a dipole decreases sinusoidally towards either end, while the voltage similarly increases. The voltages at the two ends of the antenna are 180° out of phase, which means that the polarities are opposite, one being plus while the other is minus at any instant. A curve representing either the voltage or current on a dipole represents a *standing wave* on the wire.

Radiation from Sources other than Antennas

Radiation can and does take place from sources other than antennas. Undesired radiation can take place from open-wire

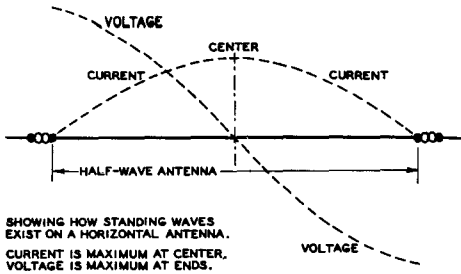

Figure 1
STANDING WAVES ON A RESONANT
ANTENNA

transmission lines, both from single-wire lines and from lines comprised of more than one wire. In addition, radiation can be made to take place in a very efficient manner from electromagnetic horns, from plastic lenses or from electromagnetic lenses made up of spaced conducting planes, from slots cut in a piece of metal, from dielectric wires, or from the open end of a wave guide.

Directivity of Radiation The radiation from any physically practicable radiating system is directive to a certain degree. The degree of directivity can be enhanced or altered when desirable through the combination of radiating elements in a prescribed manner, through the use of reflecting planes or curved surfaces, or through the use of such systems as mentioned in the preceding paragraph. The construction of directive antenna arrays is covered in detail in the chapters which follow.

Polarization Like light waves, radio waves can have a definite polarization. In fact, while light waves ordinarily have to be reflected or passed through a polarizing medium before they have a definite polarization, a radio wave leaving a simple radiator will have a definite polarization, the polarization being indicated by the orientation of the electric-field component of the wave. This, in turn, is determined by the orientation of the radiator itself, as the magnetic-field component is always at right angles to a linear radiator, and the electric-field component is always in the same plane as the radiator. Thus we see that an antenna that is vertical with respect to the earth will transmit a vertically polarized wave, as the electrostatic lines of force will be vertical. Likewise, a simple horizontal antenna will radiate horizontally polarized waves.

Because the orientation of a simple linear radiator is the same as the polarization of the waves emitted by it, the radiator itself is referred to as being either vertically or horizontally polarized. Thus, we say that a horizontal antenna is horizontally polarized.

Figure 2A illustrates the fact that the polarization of the electric field of the radiation from a vertical dipole is vertical. Figure 2B, on the other hand, shows that the polarization of electric-field radiation from a vertical slot radiator is horizontal. This fact has been utilized in certain commercial FM antennas where it is desired to have horizontally polarized radiation but where it is more convenient to use an array of vertically stacked slot arrays. If the metallic sheet is bent into a cylinder with the slot on one side, substantially omnidirectional horizontal coverage is obtained with horizontally-polarized radiation when the cylinder with the slot in one side is oriented vertically. An arrangement of this type is shown in figure 2C. Several such cylinders may be stacked vertically to reduce high-angle radiation and to concentrate the radiated energy at the useful low radiation angles.

In any event the polarization of radiation from a radiating system is parallel to the electric field as it is set up inside or in the vicinity of the radiating system.

21-2 General Characteristics of Antennas

All antennas have certain general characteristics to be enumerated. It is the result of differences in these general characteristics which makes one type of antenna system most suitable for one type of application and another type best for a different application. Six of the more important characteristics are: (1) polarization, (2) radiation resistance, (3) horizontal directivity, (4) vertical directivity, (5) bandwidth, and (6) effective power gain.

The *polarization* of an antenna or radiating system is the direction of the electric field and has been defined in Section 21-1.

The *radiation resistance* of an antenna system is normally referred to the feed point in an antenna fed at a current loop, or it is referred to a current loop in an antenna system fed at another point. The radiation resistance is that value of resistance which, if inserted in series with the antenna at a current loop, would dissipate the same energy as is actually radiated by the antenna if the antenna current at the feed point were to remain the same.

The *horizontal* and *vertical directivity* can best be expressed as a *directive pattern* which

Figure 2

ANTENNA POLARIZATION

The polarization (electric field) of the radiation from a resonant dipole such as shown at (A) above is parallel to the length of the radiator. In the case of a resonant slot cut in a sheet of metal and used as a radiator, the polarization (of the electric field) is perpendicular to the length of the slot. In both cases, however, the polarization of the radiated field is parallel to the potential gradient of the radiator; in the case of the dipole the electric lines of force are from end to end, while in the case of the slot the field is across the sides of the slot. The metallic sheet containing the slot may be formed into a cylinder to make up the radiator shown at (C). With this type of radiator the radiated field will be horizontally polarized even though the radiator is mounted vertically.

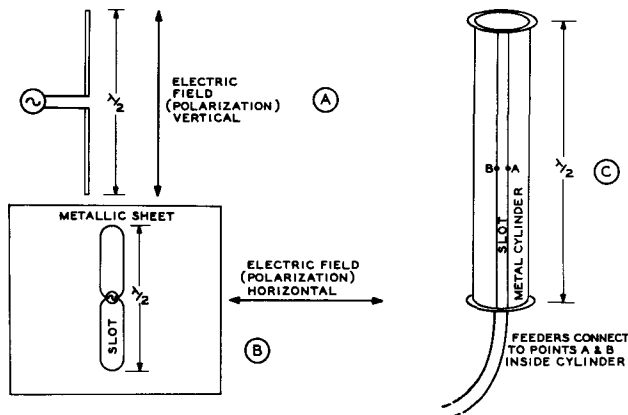

is a graph showing the relative radiated field intensity against *azimuth* angle for horizontal directivity and field intensity against *elevation* angle for vertical directivity.

The *bandwidth* of an antenna is a measure of its ability to operate within specified limits over a range of frequencies. Bandwidth can be expressed either "operating frequency plus-or-minus a specified per cent of operating frequency" or "operating frequency plus-or-minus a specified number of megacycles" for a certain standing-wave-ratio limit on the transmission line feeding the antenna system.

The *effective power gain* or *directive gain* of an antenna is the ratio between the power required in the specified antenna and the power required in a reference antenna (usually a half-wave dipole) to attain the same field strength in the favored direction of the antenna under measurement. Directive gain may be expressed either as an actual power ratio, or as is more common, the power ratio may be expressed in decibels.

Physical Length of a Half-Wave Antenna If the cross section of the conductor which makes up the antenna is kept very small with respect to the antenna length, an electrical half wave is a fixed percentage shorter than a physical half-wavelength. This percentage is approximately 5 per cent. Therefore, most linear half-wave antennas are close to 95 per cent of a half wavelength long physically. Thus, a half-wave antenna resonant at exactly 80 meters would be one-half of 0.95 times 80 meters in length. Another way of saying the same thing is that a

wire resonates at a wavelength of about 2.1 times its length in meters. If the diameter of the conductor begins to be an appreciable fraction of a wavelength, as when tubing is used as a v-h-f radiator, the factor becomes slightly less than 0.95. For the use of wire and not tubing on frequencies below 30 Mc., however, the figure of 0.95 may be taken as accurate. This assumes a radiator removed from surrounding objects, and with *no bends*.

Simple conversion into feet can be obtained by using the factor 1.56. To find the physical length of a half-wave 80-meter antenna, we multiply 80 times 1.56, and get 124.8 feet for the length of the radiator.

It is more common to use frequency than wavelength when indicating a specific spot in the radio spectrum. For this reason, the relationship between wavelength and frequency must be kept in mind. As the velocity of radio waves through space is constant at the speed of light, it will be seen that the more waves that pass a point per second (higher frequency), the closer together the peaks of those waves must be (shorter wavelength). Therefore, the higher the frequency, the lower will be the wavelength.

A radio wave in space can be compared to a wave in water. The wave, in either case, has peaks and troughs. One peak and one trough constitute a *full wave*, or *one wavelength*.

Frequency describes the number of wave cycles or peaks passing a point per second. Wavelength describes the distance the wave travels through space during one cycle or oscillation of the antenna current; it is the

distance in meters between adjacent peaks or adjacent troughs of a wave train.

As a radio wave travels 300,000,000 meters a second (speed of light), a frequency of 1 cycle per second corresponds to a wavelength of 300,000,000 meters. So, if the frequency is multiplied by a million, the wavelength must be divided by a million, in order to maintain their correct ratio.

A frequency of 1,000,000 cycles per second (1,000 kc.) equals a wavelength of 300 meters. Multiplying frequency by 10 and dividing wavelength by 10, we find: a frequency of 10,000 kc. equals a wavelength of 30 meters. Multiplying and dividing by 10 again, we get: a frequency of 100,000 kc. equals 3 meters wavelength. Therefore, to change wavelength to frequency (in kilocycles), simply divide 300,000 by the wavelength in meters (λ).

$$F \text{ kc} = \frac{300,000}{\lambda}$$

$$\lambda = \frac{300,000}{F \text{ kc}}$$

Now that we have a simple conversion formula for converting wavelength to frequency and vice versa, we can combine it with our wavelength versus antenna length formula, and we have the following:

Length of a half-wave radiator made from wire (no. 14 to no. 10):

3.5-Mc. to 30-Mc. bands

$$\text{Length in feet} = \frac{468}{\text{Freq. in Mc.}}$$

50-Mc. band

$$\text{Length in feet} = \frac{460}{\text{Freq. in Mc.}}$$

$$\text{Length in inches} = \frac{5600}{\text{Freq. in Mc.}}$$

144-Mc. band

$$\text{Length in inches} = \frac{5500}{\text{Freq. in Mc.}}$$

Length-to-Diameter Ratio When a half-wave radiator is constructed from tubing or rod whose diameter is an appreciable fraction of the length of the radiator, the resonant length of a half-wave antenna will be shortened. The amount of

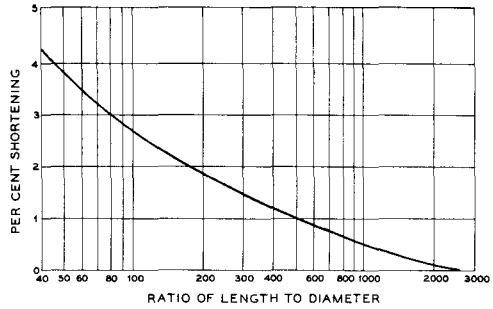

Figure 3
CHART SHOWING SHORTENING OF A RESONANT ELEMENT IN TERMS OF RATIO OF LENGTH TO DIAMETER

The use of this chart is based on the basic formula where radiator length in feet is equal to 468/frequency in Mc. This formula applies to frequencies below perhaps 30 Mc. when the radiator is made from wire. On higher frequencies, or on 14 and 28 Mc. when the radiator is made of large-diameter tubing, the radiator is shortened from the value obtained with the above formula by an amount determined by the ratio of length to diameter of the radiator. The amount of this shortening is obtainable from the chart shown above.

shortening can be determined with the aid of the chart of figure 3. In this chart the amount of additional shortening over the values given in the previous paragraph is plotted against the ratio of the length to the diameter of the half-wave radiator.

The length of a wave in free space is somewhat longer than the length of an antenna for the same frequency. The actual free-space half-wavelength is given by the following expressions:

$$\text{Half-wavelength} = \frac{492}{\text{Freq. in Mc.}} \text{ in feet}$$

$$\text{Half-wavelength} = \frac{5905}{\text{Freq. in Mc.}} \text{ in inches}$$

Harmonic Resonance A wire in space can resonate more than one frequency. The lowest frequency at which it resonates is called its *fundamental* frequency, and at that frequency it is approximately a half wavelength long. A wire can have two, three, four, five, or more standing waves on it, and thus it resonates at approximately the integral harmonics of its fundamental frequency. However, the higher harmonics are not exactly integral multiples of the lowest resonant frequency as a result of *end effects*.

A harmonic operated antenna is somewhat longer than the corresponding integral number of dipoles, and for this reason, the dipole length formula cannot be used simply by multiplying by the corresponding harmonic. The intermediate half wave sections do not have *end effects*. Also, the current distribution is disturbed by the fact that power can reach some of the half wave sections only by flowing through other sections, the latter then acting not only as radiators, but also as transmission lines. For the latter reason, the resonant length will be dependent to an extent upon the method of feed, as there will be less attenuation of the current along the antenna if it is fed at or near the center than if fed towards or at one end. Thus, the antenna would have to be somewhat longer if fed near one end than if fed near the center. The difference would be small, however, unless the antenna were many wavelengths long.

The length of a center fed harmonically operated doublet may be found from the formula:

$$L = \frac{(K-.05) \times 492}{\text{Freq. in Mc.}}$$

where K = number of $\frac{1}{2}$ waves on antenna

L = length in feet

Under conditions of severe current attenuation, it is possible for some of the nodes, or loops, actually to be slightly greater than a physical half wavelength apart. Practice has shown that the most practical method of resonating a harmonically operated antenna accurately is by cut and try, or by using a feed system in which both the feed line and antenna are resonated at the station end as an integral system.

A dipole or half-wave antenna is said to operate on its fundamental or first harmonic. A full wave antenna, 1 wavelength long, operates on its second harmonic. An antenna with five half-wavelengths on it would be operating on its fifth harmonic. Observe that the fifth harmonic antenna is $2\frac{1}{2}$ wavelengths long, not 5 wavelengths.

Antenna Resonance Most types of antennas operate most efficiently when tuned or resonated to the frequency of operation. This consideration of course does not apply to the rhombic antenna and to the parasitic elements of arrays employing parasitically excited elements. However, in practically every other case it will be found that increased efficiency results when the entire antenna system is resonant, whether it be a simple dipole or an elaborate array. The radiation efficiency of a resonant wire is many times that of a wire which is not resonant.

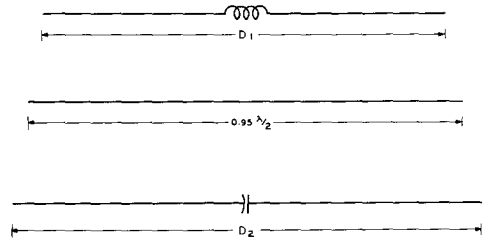

Figure 4
EFFECT OF SERIES INDUCTANCE AND CAPACITANCE ON THE LENGTH OF A HALF-WAVE RADIATOR

The top antenna has been electrically lengthened by placing a coil in series with the center. In other words, an antenna with a lumped inductance in its center can be made shorter for a given frequency than a plain wire radiator. The bottom antenna has been capacitively shortened electrically. In other words, an antenna with a capacitor in series with it must be made longer for a given frequency since its effective electrical length as compared to plain wire is shorter.

If an antenna is slightly too long, it can be resonated by series insertion of a variable capacitor at a high current point. If it is slightly too short, it can be resonated by means of a variable inductance. These two methods, illustrated schematically in figure 4, are generally employed when part of the antenna is brought into the operating room.

With an antenna array, or an antenna fed by means of a transmission line, it is more common to cut the elements to exact resonant length by "cut and try" procedure. Exact antenna resonance is more important when the antenna system has low radiation resistance; an antenna with low radiation resistance has higher Q (tunes sharper) than an antenna with high radiation resistance. The higher Q does not indicate greater efficiency; it simply indicates a sharper resonance curve.

21-3 Radiation Resistance and Feed-Point Impedance

In many ways, a half-wave antenna is like a tuned tank circuit. The main difference lies in the fact that the elements of inductance, capacitance, and resistance are lumped in the tank circuit, and are distributed throughout the length of an antenna. The center of a half-wave radiator is effectively at ground potential as far as r-f voltage is concerned, although the current is highest at that point.

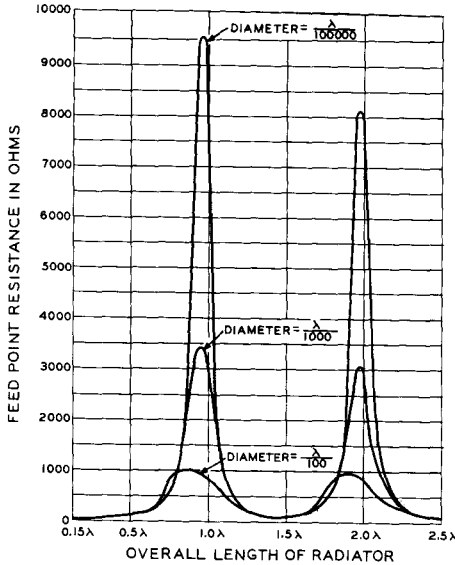

Figure 5
FEED POINT RESISTANCE OF A CENTER DRIVEN RADIATOR AS A FUNCTION OF PHYSICAL LENGTH IN TERMS OF FREE SPACE WAVELENGTH

When the antenna is resonant, and it always should be for best results, the impedance at the center is substantially resistive, and is termed the radiation resistance. Radiation resistance is a fictitious term; it is that value of resistance (referred to the current loop) which would dissipate the same amount of power as being radiated by the antenna, when fed with the current flowing at the current loop.

The radiation resistance depends on the antenna length and its proximity to nearby objects which either absorb or re-radiate power, such as the ground, other wires, etc.

The Marconi Antenna Before going too far with the discussion of radiation resistance, an explanation of the Marconi (grounded quarter wave) antenna is in order. The Marconi antenna is a special type of Hertz antenna in which the earth acts as the "other half" of the dipole. In other words, the current flows into the earth instead of into a similar quarter-wave section. Thus, the current loop of a Marconi antenna is at the *base* rather than in the *center*. In either case it is a quarter wavelength from the end.

A half-wave dipole far from ground and other reflecting objects has a radiation resistance at the center of about 73 ohms. A Marconi an-

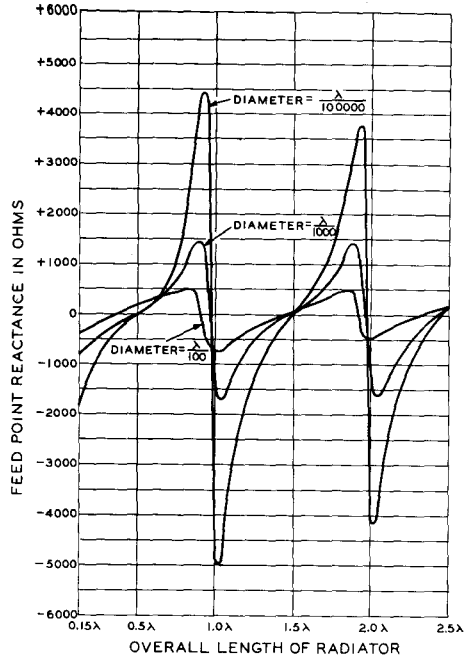

Figure 6
REACTIVE COMPONENT OF THE FEED POINT IMPEDANCE OF A CENTER DRIVEN RADIATOR AS A FUNCTION OF PHYSICAL LENGTH IN TERMS OF FREE SPACE WAVELENGTH

tenna is simply one-half of a dipole. For that reason, the radiation resistance is roughly half the 73-ohm impedance of the dipole or 36.5 ohms. The radiation resistance of a Marconi antenna such as a mobile whip will be lowered by the proximity of the automobile body.

Antenna Impedance Because the power throughout the antenna is the same, the *impedance* of a resonant antenna at any point along its length merely expresses the ratio between voltage and current at that point. Thus, the lowest impedance occurs where the current is highest, namely, at the center of a dipole, or a quarter wave from the end of a Marconi. The impedance rises uniformly toward each end, where it is about 2000 ohms for a dipole remote from ground, and about twice as high for a vertical Marconi.

If a vertical half-wave antenna is set up so that its lower end is at the ground level, the effect of the ground reflection is to increase

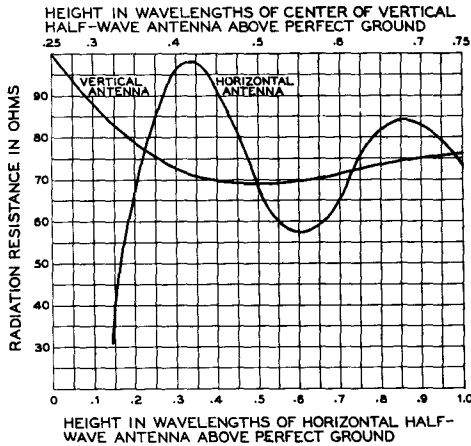

Figure 7
EFFECT OF HEIGHT ON THE RADIATION RESISTANCE OF A DIPOLE SUSPENDED ABOVE PERFECT GROUND

the radiation resistance to approximately 100 ohms. When a horizontal half-wave antenna is used, the radiation resistance (and, of course, the amount of energy radiated for a given antenna current) depends on the height of the antenna above ground, since the height determines the phase and amplitude of the wave reflected from the ground back to the antenna. Thus the resultant current in the antenna for a given power is a function of antenna height.

Center-fed Feed Point Impedance When a linear radiator is series fed at the center, the resistive and reactive components of the driving point impedance are dependent upon both the length and diameter of the radiator in wavelengths. The manner in which the resistive component varies with the physical dimensions of the radiator is illustrated in figure 5. The manner in which the reactive component varies is illustrated in figure 6.

Several interesting things will be noted with respect to these curves. The reactive component disappears when the overall physical length is slightly less than any number of half waves long, the differential increasing with conductor diameter. For overall lengths in the vicinity of an odd number of half wavelengths, the center feed point looks to the generator or transmission line like a series-resonant lumped circuit, while for overall lengths in the vicinity of an even number of half wavelengths, it looks like a parallel-resonant or anti-resonant lumped circuit. Both the feed point resistance

and the feed point reactance *change more slowly* with overall radiator length (or with frequency with a fixed length) as the conductor diameter is increased, indicating that the effective "Q" is lowered as the diameter is increased. However, in view of the fact that the damping resistance is nearly all "radiation resistance" rather than loss resistance, the lower Q does not represent lower efficiency. Therefore, the lower Q is desirable, because it permits use of the radiator over a wider frequency range without resorting to means for eliminating the reactive component. Thus, the use of a large diameter conductor makes the overall system less frequency sensitive. If the diameter is made sufficiently large in terms of wavelengths, the Q will be low enough to qualify the radiator as a "broad-band" antenna.

The curves of figure 7 indicate the theoretical center-point radiation resistance of a half-wave antenna for various heights above perfect ground. These values are of importance in matching untuned radio-frequency feeders to the antenna, in order to obtain a good impedance match and an absence of standing waves on the feeders.

Ground Losses Above average ground, the actual radiation resistance of a dipole will vary from the exact value of figure 7 since the latter assumes a hypothetical, perfect ground having no loss and perfect reflection. Fortunately, the curves for the radiation resistance over most types of earth will correspond rather closely with those of the chart, except that the radiation resistance for a horizontal dipole does not fall off as rapidly as is indicated for heights below an eighth wavelength. However, with the antenna so close to the ground and the soil in a strong field, much of the radiation resistance is actually represented by ground loss; this means that a good portion of the antenna power is being dissipated in the earth, which, unlike the hypothetical perfect ground, has resistance. In this case, an appreciable portion of the radiation resistance actually is loss resistance. The type of soil also has an effect upon the radiation pattern, especially in the vertical plane, as will be seen later.

The radiation resistance of an antenna generally increases with length, although this increase varies up and down about a constantly increasing average. The peaks and dips are caused by the reactance of the antenna, when its length does not allow it to resonate at the operating frequency.

Antenna Efficiency Antennas have a certain loss resistance as well as a radiation resistance. The loss resistance defines the power lost in the antenna due to ohm-

ic resistance of the wire, ground resistance (in the case of a Marconi), corona discharge, and insulator losses.

The approximate effective radiation efficiency (expressed as a decimal) is equal to: $N_r = R_a / (R_a + R_L)$ where R_a is equal to the radiation resistance and R_L is equal to the effective loss resistance of the antenna. The loss resistance will be of the order of 0.25 ohm for large-diameter tubing conductors such as are most commonly used in multi-element parasitic arrays, and will be of the order of 0.5 to 2.0 ohms for arrays of normal construction using copper wire.

When the radiation resistance of an antenna or array is very low, the current at a voltage node will be quite high for a given power. Likewise, the voltage at a current node will be very high. Even with a heavy conductor and excellent insulation, the losses due to the high voltage and current will be appreciable if the radiation resistance is sufficiently low.

Usually, it is not considered desirable to use an antenna or array with a radiation resistance of less than approximately 5 ohms unless there is sufficient directivity, compactness, or other advantage to offset the losses resulting from the low radiation resistance.

Ground Resistance The radiation resistance of a Marconi antenna, especially, should be kept as high as possible. This will reduce the antenna current for a given power, thus minimizing loss resulting from the series resistance offered by the earth connection. The radiation resistance can be kept high by making the Marconi radiator somewhat longer than a quarter wave, and shortening it by series capacitance to an electrical quarter wave. This reduces the current flowing in the earth connection. It also should be removed from ground as much as possible (vertical being ideal). Methods of minimizing the resistance of the earth connection will be found in the discussion of the Marconi antenna.

21-4 Antenna Directivity

All practical antennas radiate better in some directions than others. This characteristic is called *directivity*. The more *directive* an antenna is, the more it concentrates the radiation in a certain direction, or directions. The more the radiation is concentrated in a certain direction, the greater will be the field strength produced in that direction for a given amount of total radiated power. Thus the use of a directional antenna or *array* produces the same result in the favored direction as an increase in the power of the transmitter.

The increase in radiated power in a certain

direction with respect to an antenna in free space as a result of inherent directivity is called the *free space directivity power gain* or just *space directivity gain* of the antenna (referred to a hypothetical *isotropic radiator* which is assumed to radiate equally well in all directions). Because the fictitious isotropic radiator is a purely academic antenna, not physically realizable, it is common practice to use as a reference antenna the simplest ungrounded resonant radiator, the half-wave *Hertz*, or resonant doublet. As a half-wave doublet has a space directivity gain of 2.15 db over an isotropic radiator, the use of a resonant dipole as the comparison antenna reduces the *gain figure* of an array by 2.15 db. However, it should be understood that power gain can be expressed with regard to *any* antenna, just so long as it is specified.

As a matter of interest, the directivity of an *infinitesimal dipole* provides a free space directivity power gain of 1.5 (or 1.76 db) over an isotropic radiator. This means that in the *direction of maximum radiation* the infinitesimal dipole will produce the same field of strength as an isotropic radiator which is radiating 1.5 times as much total power.

A half-wave resonant doublet, because of its different current distribution and significant length, exhibits slightly more free space power gain as a result of directivity than does the infinitesimal dipole, for reasons which will be explained in a later section. The space directivity power gain of a half-wave resonant doublet is 1.63 (or 2.15 db) referred to an isotropic radiator.

Horizontal Directivity When choosing and orienting an antenna system, the radiation patterns of the various common types of antennas should be given careful consideration. The directional characteristics are of still greater importance when a directive antenna array is used.

Horizontal directivity is always desirable on any frequency for point-to-point work. However, it is not always attainable with reasonable antenna dimensions on the lower frequencies. Further, when it is attainable, as on the frequencies above perhaps 7 Mc., with reasonable antenna dimensions, operating convenience is greatly furthered if the maximum lobe of the horizontal directivity is controllable. It is for this reason that rotatable antenna arrays have come into such common usage.

Considerable horizontal directivity can be used to advantage when: (1) only point-to-point work is necessary, (2) several arrays are available so that directivity may be changed by selecting or reversing antennas, (3) a single rotatable array is in use. Signals follow the

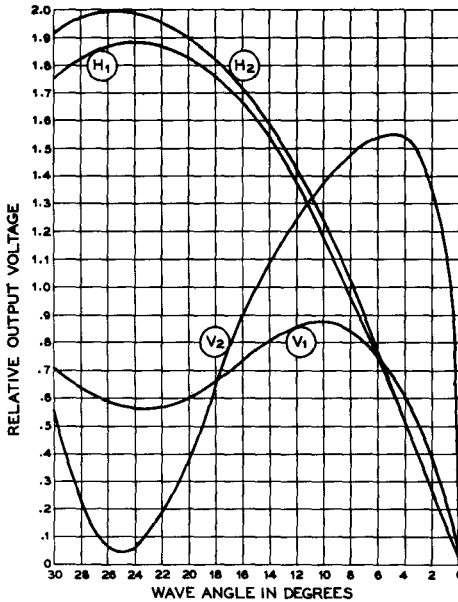

Figure 8
VERTICAL-PLANE DIRECTIONAL CHARACTERISTICS OF HORIZONTAL AND VERTICAL DOUBLETS ELEVATED 0.6 WAVELENGTH AND ABOVE TWO TYPES OF GROUND

H₁ represents a horizontal doublet over typical farmland, H₂ over salt water. V₁ is a vertical pattern of radiation from a vertical doublet over typical farmland, V₂ over salt water. A salt water ground is the closest approach to an extensive ideally perfect ground that will be met in actual practice.

great-circle path, or within 2 or 3 degrees of that path under all normal propagation conditions. However, under turbulent ionosphere conditions, or when unusual propagation conditions exist, the deviation from the great-circle path for greatest signal intensity may be as great as 90°. Making the array rotatable overcomes these difficulties, but arrays having extremely high horizontal directivity become too cumbersome to be rotated, except perhaps when designed for operation on frequencies above 50 Mc.

Vertical Directivity Vertical directivity is of the greatest importance in obtaining satisfactory communication above 14 Mc. whether or not horizontal directivity is used. This is true simply because *only* the energy radiated between certain definite *elevation* angles is useful for communication. Ener-

gy radiated at other elevation angles is lost and performs no useful function.

Optimum Angle of Radiation The optimum angle of radiation for propagation of signals between two points is dependent upon a number of variables. Among these significant variables are: (1) height of the ionosphere layer which is providing the reflection, (2) distance between the two stations, (3) number of hops for propagation between the two stations. For communication on the 14-Mc. band it is often possible for different modes of propagation to provide signals between two points. This means, of course, that more than one angle of radiation can be used. If *no* elevation directivity is being used under this condition of propagation, selective fading will take place because of interference between the waves arriving over the different paths.

On the 28-Mc. band it is by far the most common condition that only one mode of propagation will be possible between two points at any one time. This explains, of course, the reason why rapid fading in general and selective fading in particular are almost absent from signals heard on the 28-Mc. band (except for fading caused by local effects).

Measurements have shown that the angles useful for communication on the 14-Mc. band are from 3° to about 30°; angles above about 15° being useful only for local work. On the 28-Mc. band measurements have shown that the useful angles range from about 3° to 18°; angles above about 12° being useful only for local (less than 3000 miles) work. These figures assume normal propagation by virtue of the *F₂* layer.

Angle of Radiation of Typical Antennas and Arrays It now becomes of interest to determine the amount of radiation available

at these useful low-angles of radiation from commonly used antennas and antenna arrays. Figure 8 shows relative output voltage plotted against elevation angle (wave angle) in degrees above the horizontal, for horizontal and vertical doublets elevated 0.6 wavelength above two types of ground. It is obvious by inspection of the curves that a horizontal dipole mounted at this height above ground (20 feet on the 28-Mc. band) is radiating only a small amount of energy at angles useful for communication on the 28-Mc. band. Most of the energy is being radiated uselessly upward. The vertical antenna above a good reflecting surface appears much better in this respect—and this fact has been proven many times by actual installations.

It might immediately be thought that the amount of radiation from a horizontal or vertical

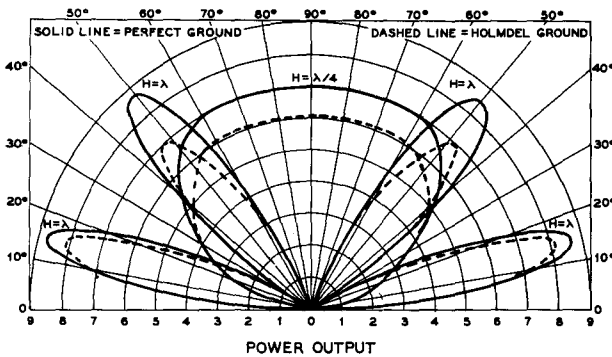

Figure 9
VERTICAL RADIATION
PATTERNS

Showing the vertical radiation patterns for half-wave antennas (or colinear half-wave or extended half-wave antennas) at different heights above average ground and perfect ground. Note that such antennas one-quarter wave above ground concentrate most radiation at the very high angles which are useful for communication only on the lower frequency bands. Antennas one-half wave above ground are not shown, but the elevation pattern shows one lobe at 30° above horizontal.

dipole could be increased by raising the antenna higher above the ground. This is true to an extent in the case of the horizontal dipole; the low-angle radiation does increase *slowly* after a height of 0.6 wavelength is reached but at the expense of greatly increased high-angle radiation and the formation of a number of nulls in the elevation pattern. No signal can be transmitted or received at the elevation angles where these nulls have been formed. Tests have shown that a center height of 0.6 wavelength for a vertical dipole (0.35 wavelength to the bottom end) is about optimum for this type of array.

Figure 9 shows the effect of placing a horizontal dipole at various heights above ground. It is easily seen by reference to figure 9 (and figure 10 which shows the radiation from a dipole at $\frac{3}{4}$ wave height) that a large percentage of the total radiation from the dipole is being radiated at relatively high angles which are useless for communication on the 14-Mc. and 28-Mc. bands. Thus we see that in order to obtain a worthwhile increase in the ratio of low-angle radiation to high-angle radiation it is necessary to place the antenna high above ground, *and in addition* it is necessary to use

additional means for suppressing high-angle radiation.

Suppression of High-angle Radiation can be suppressed, and this radiation can be added to that going out at low angles, only through the

use of some sort of *directive* antenna system. There are three general types of antenna arrays composed of dipole elements commonly used which concentrate radiation at the lower more effective angles for high-frequency communication. These types are: (1) The close-spaced out-of-phase system as exemplified by the "flat-top" beam or W8JK array. Such configurations are classified as *end fire arrays*. (2) The wide-spaced in-phase arrays, as exemplified by the "Lazy H" antenna. These configurations are classified as *broadside arrays*. (3) The close-spaced parasitic systems, as exemplified by the three element rotary beam.

A comparison between the radiation from a dipole, a "flat-top beam" and a pair of dipoles stacked one above the other (half of a "lazy H"), in each case with the top of the antenna at a height of $\frac{3}{4}$ wavelength is shown in figure 11. The improvement in the amplitude of low-

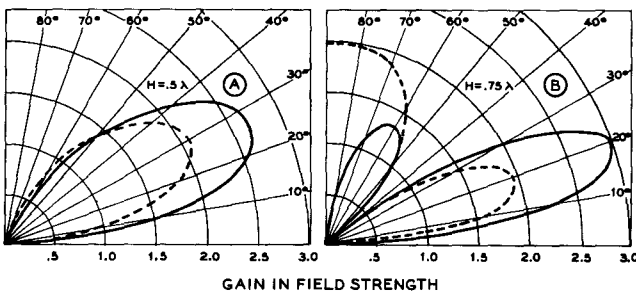
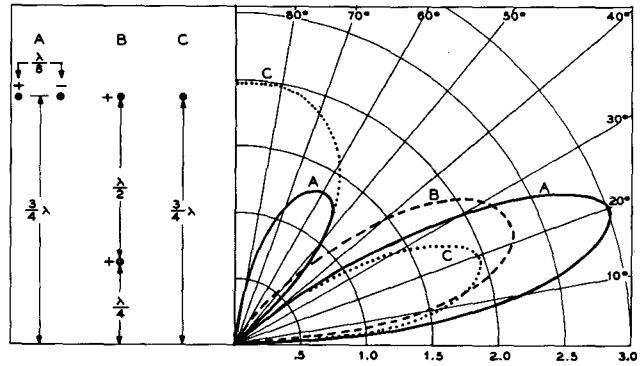

Figure 10
VERTICAL RADIATION
PATTERNS

Showing vertical-plane radiation patterns of a horizontal single-section flat-top beam with one-eighth wave spacing (solid curves) and a horizontal half-wave antenna (dashed curves) when both are 0.5 wavelength (A) and 0.75 wavelength (B) above ground.

Figure 11
COMPARATIVE VERTICAL RADIATION PATTERNS

Showing the vertical radiation patterns of a horizontal single-section flat-top beam (A), an array of two stacked horizontal in-phase half-wave elements—half of a "Lazy H"—(B), and a horizontal dipole (C). In each case the top of the antenna system is 0.75 wavelength above ground, as shown to the left of the curves.



angle radiation at the expense of the useless high-angle radiation with these simple arrays as contrasted to the dipole is quite marked.

Figure 12 compares the patterns of a 3 element beam and a dipole radiator at a height of 0.75 wavelength. It will be noticed that although there is more energy in the lobe of the beam as compared to the dipole, the axis of the beam is at the same angle above the horizontal. Thus, although more radiated energy is provided by the beam at low angles, the average angle of radiation of the beam is no lower than the average angle of radiation of the dipole.

21-6 Propagation of Radio Waves

The preceding sections have discussed the manner in which an electromagnetic-wave or radio-wave field may be set up by a radiating system. However, for this field to be useful for communication it must be propagated to some distant point where it may be received, or where it may be reflected so that it may be received at some other point. Radio waves may be propagated to a remote point by either or both of two general methods. Propagation

21-5 Bandwidth

The bandwidth of an antenna or an antenna array is a function primarily of the radiation resistance and of the shape of the conductors which make up the antenna system. For arrays of essentially similar construction the bandwidth (or the deviation in frequency which the system can handle without mismatch) is increased with increasing radiation resistance, and the bandwidth is increased with the use of conductors of larger diameter (smaller ratio of length to diameter). This is to say that if an array of any type is constructed of large diameter tubing or spaced wires, its bandwidth will be greater than that of a similar array constructed of single wires.

The radiation resistance of antenna arrays of the types mentioned in the previous paragraphs may be increased through the use of wider spacing between elements. With increased radiation resistance in such arrays the radiation efficiency increases since the ohmic losses within the conductors become a smaller percentage of the radiation resistance, and the bandwidth is increased proportionately.

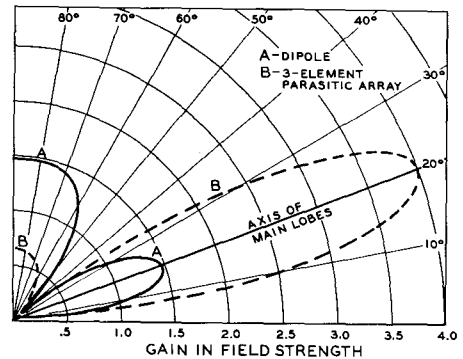

Figure 12
VERTICAL RADIATION PATTERNS

Showing vertical radiation patterns of a horizontal dipole (A) and a horizontal 3-element parasitic array (B) at a height above ground of 0.75 wavelength. Note that the axis of the main radiation lobes are at the same angle above the horizontal. Note also the suppression of high angle radiation by the parasitic array.

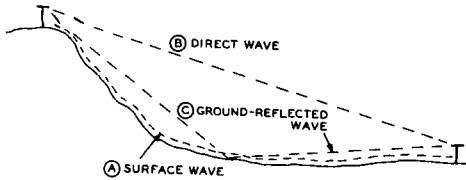

Figure 13

GROUND-WAVE SIGNAL PROPAGATION

The illustration above shows the three components of the ground wave: (A), the surface wave; (B), the direct wave; and (C), the ground-reflected wave. The direct wave and the ground-reflected wave combine at the receiving antenna to make up the space wave.

may take place as a result of the *ground wave*, or as a result of the *sky wave* or *ionospheric wave*.

The Ground Wave The term *ground wave* actually includes several different types of waves which usually are called: (1) the *surface wave*, (2) the *direct wave*, and (3) the *ground-reflected wave*. The latter two waves combine at the receiving antenna to form the *resultant wave* or the *space wave*. The distinguishing characteristic of the components of the ground wave is that all travel along or over the surface of the earth, so that they are affected by the conductivity and terrain of the earth's surface.

The Ionospheric Wave or Sky Wave Intense bombardment of the upper regions of the atmosphere by radiations from the sun results in the formation of ionized layers. These ionized layers, which form the *ionosphere*, have the capability of reflecting or refracting radio waves which impinge upon them. A radio wave which has been propagated as a result of one or more reflections from the ionosphere is known as an *ionospheric wave* or a *sky wave*. Such waves make possible long distance radio communication. Propagation of radio signals by ionospheric waves is discussed in detail in Section 21-8.

21-7 Ground-Wave Communication

As stated in the preceding paragraph, the term *ground wave* applies both to the *surface wave* and to the *space wave* (the resultant wave from the combination of the direct wave and the ground-reflected wave) or to a com-

bination of the two. The three waves which may combine to make up the ground wave are illustrated in figure 13.

The Surface Wave The surface wave is that wave which we normally receive from a standard broadcast station. It travels directly along the ground and terminates on the earth's surface. Since the earth is a relatively poor conductor, the surface wave is attenuated quite rapidly. The surface wave is attenuated less rapidly as it passes over sea water, and the attenuation decreases for a specific distance as the frequency is decreased. The rate of attenuation with distance becomes so large as the frequency is increased above about 3 Mc. that the surface wave becomes of little value for communication.

The Space Wave The resultant wave or space wave is illustrated in figure 13 by the combination of (B) and (C). It is this wave path, which consists of the combination of the direct wave and the ground-reflected wave at the receiving antenna, which is the *normal* path of signal propagation for line-of-sight or near line-of-sight communication or FM and TV reception on frequencies above about 40 Mc.

Below line-of-sight over plane earth or water, when the signal source is effectively at the horizon, the ground-reflected wave does not exist, so that the *direct wave* is the only component which goes to make up the space wave. But when both the signal source and the receiving antenna are elevated with respect to the intervening terrain, the ground-reflected wave is present and adds vectorially to the direct wave at the receiving antenna. The vectorial addition of the two waves, which travel over different path lengths (since one of the waves has been reflected from the ground) results in an interference pattern. The interference between the two waves brings about a cyclic variation in signal strength as the receiving antenna is raised above the ground. This effect is illustrated in figure 14. From this figure it can be seen that best space-wave reception of a v-h-f signal often will be obtained with the receiving antenna quite close to the ground. This subject, along with other aspects of v-h-f signal propagation and reception, are discussed in considerable detail in a book on fringe-area TV reception.*

The distance from an elevated point to the geometrical horizon is given by the approximate equation: $d = 1.22\sqrt{H}$ where the distance

* "Better TV Reception," by W. W. Smith and R. L. Dawley, published by Editors and Engineers, Ltd., Summerland, Calif.

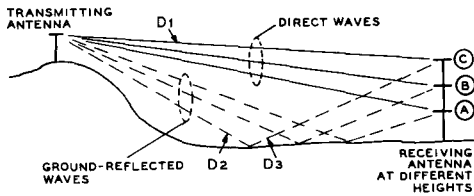

Figure 14

WAVE INTERFERENCE WITH HEIGHT

When the source of a horizontally-polarized space-wave signal is above the horizon, the received signal at a distant location will go through a cyclic variation as the antenna height is progressively raised. This is due to the difference in total path length between the direct wave and the ground-reflected wave, and to the fact that this path length difference changes with antenna height. When the path length difference is such that the two waves arrive at the receiving antenna with a phase difference of 360° or some multiple of 360° , the two waves will appear to be in phase as far as the antenna is concerned and maximum signal will be obtained. On the other hand, when the antenna height is such that the path length difference for the two waves causes the waves to arrive with a phase difference of an odd multiple of 180° the two waves will substantially cancel, and a null will be obtained at that antenna height. The difference between D_1 and D_2 plus D_3 is the path-length difference. Note also that there is an additional 180° phase shift in the ground-reflected wave at the point where it is reflected from the ground. It is this latter phase shift which causes the space-wave field intensity of a horizontally polarized wave to be zero with the receiving antenna at ground level.

d is in miles and the antenna height H is in feet. This equation must be applied separately to the transmitting and receiving antennas and the results added. However, refraction and diffraction of the signal around the spherical earth cause a smaller reduction in field strength than would occur in the absence of such bending, so that the average radio horizon is somewhat beyond the geometrical horizon. The equation $d = 1.4 \sqrt{H}$ is sometimes used for determining the radio horizon.

Tropospheric Propagation Propagation by signal bending in the lower atmosphere, called *tropospheric propagation*, can result in the reception of signals over a much greater distance than would be the case if the lower atmosphere were homogeneous. In a homogeneous or well-mixed lower atmosphere, called a *normal* or *standard* atmosphere, there is a gradual and uniform decrease in index of refraction with height. This effect is due to

the combined effects of a decrease in temperature, pressure, and water-vapor content with height.

This gradual decrease in refractive index with height causes waves radiated at very low angles with respect to the horizontal to be bent downward slightly in a curved path. The result of this effect is that such waves will be propagated beyond the *true* or *geometrical* horizon. In a so-called standard atmosphere the effect of the curved path is the same as though the radius of the earth were increased by approximately one third. This condition extends the horizon by approximately 30 per cent for normal propagation, and the extended-horizon is known as the *radio path horizon*, mentioned before.

Conditions Leading to Tropospheric Stratification When the temperature, pressure, or water-vapor content of the atmosphere does not change smoothly with rising altitude, the discontinuity or stratification will result in the reflection or refraction of incident v-h-f signals. Ordinarily this condition is more prevalent at night and in the summer. In certain areas, such as along the west coast of North America, it is frequent enough to be considered normal. Signal strength decreases slowly with distance and, if the favorable condition in the lower atmosphere covers sufficient area, the range is limited only by the transmitter power, antenna gain, receiver sensitivity, and signal-to-noise ratio. There is no skip distance. Usually, transmission due to this condition is accompanied by slow fading, although fading can be violent at a point where direct waves of about the same strength are also received.

Bending in the troposphere, which refers to the region from the earth's surface up to about 10 kilometers, is more likely to occur on days when there are stratus clouds than on clear, cool days with a deep blue sky. The temperature or humidity discontinuities may be broken up by vertical convection currents over land in the daytime but are more likely to continue during the day over water. This condition is in some degree predictable from weather information several days in advance. It does not depend on the sunspot cycle. Like direct communication, best results require similar antenna polarization or orientation at both the transmitting and receiving ends, whereas in transmission via reflection in the ionosphere (that part of the atmosphere between about 50 and 500 kilometers high) it makes little difference whether antennas are similarly polarized.

Duct Formation When bending conditions are particularly favorable they

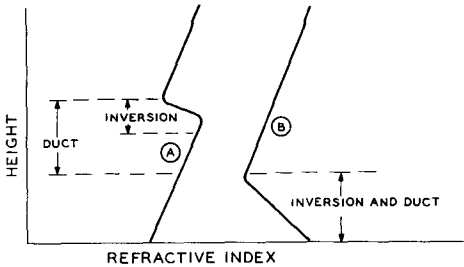

Figure 15

ILLUSTRATING DUCT TYPES

Showing two types of variation in refractive index with height which will give rise to the formation of a duct. An elevated duct is shown at (A), and a ground-based duct is shown at (B). Such ducts can propagate ground-wave signals far beyond their normal range.

may give rise to the formation of a *duct* which can propagate waves with very little attenuation over great distances in a manner similar to the propagation of waves through a wave guide. *Guided propagation* through a duct in the atmosphere can give quite remarkable transmission conditions (figure 15). However, such ducts usually are formed only on an over-water path. The depth of the duct over the water's surface may be only 20 to 50 feet, or it may be 1000 feet deep or more. Ducts exhibit a low-frequency cutoff characteristic similar to a wave guide. The cutoff frequency is determined by depth of the duct and by the strength of the discontinuity in refractive index at the upper surface of the duct. The lowest frequency that can be propagated by such a duct seldom goes below 50 Mc., and usually will be greater than 100 Mc. even along the Pacific Coast.

Stratospheric Reflection Communication by virtue of stratospheric reflection can be brought about during magnetic storms, aurora borealis displays, and during meteor showers. Dx communication during extensive meteor showers is characterized by frequent bursts of great signal strength followed by a rapid decline in strength of the received signal. The motion of the meteor forms an ionized trail of considerable extent which can bring about effective reflection of signals. However, the ionized region persists only for a matter of seconds so that a shower of meteors is necessary before communication becomes possible.

The type of communication which is possible during visible displays of the aurora borealis

and during magnetic storms has been called *aurora-type dx*. These conditions reach a maximum somewhat after the sunspot cycle peak, possibly because the spots on the sun are nearer to its equator (and more directly in line with the earth) in the latter part of the cycle. Ionospheric storms generally accompany magnetic storms. The normal layers of the ionosphere may be churned or broken up, making radio transmission over long distances difficult or impossible on high frequencies. Unusual conditions in the ionosphere sometimes modulate v-h-f waves so that a definite tone or noise modulation is noticed even on transmitters located only a few miles away.

A peculiarity of this type of auroral propagation of v-h-f signals in the northern hemisphere is that directional antennas usually must be pointed in a northerly direction for best results for transmission or reception, regardless of the direction of the other station being contacted. Distances out to 700 or 800 miles have been covered during magnetic storms, using 30 and 50 Mc. transmitters, with little evidence of any silent zone between the stations communicating with each other. Generally, voice-modulated transmissions are difficult or impossible due to the tone or noise modulation on the signal. Most of the communication of this type has taken place by c.w. or by tone modulated waves with a keyed carrier.

21-8

Ionospheric Propagation

Propagation of radio waves for communication on frequencies between perhaps 3 and 30 Mc. is normally carried out by virtue of *ionospheric reflection* or *refraction*. Under conditions of abnormally high ionization in the ionosphere, communication has been known to have taken place by ionospheric reflection on frequencies higher than 50 Mc.

The ionosphere consists of layers of ionized gas located above the stratosphere, and extending up to possibly 300 miles above the earth. Thus we see that high-frequency radio waves may travel over short distances in a direct line from the transmitter to the receiver, or they can be radiated upward into the ionosphere to be bent downward in an indirect ray, returning to earth at considerable distance from the transmitter. The wave reaching a receiver via the ionosphere route is termed a *sky wave*. The wave reaching a receiver by traveling in a direct line from the transmitting antenna to the receiving antenna is commonly called a *ground wave*.

The amount of bending at the ionosphere

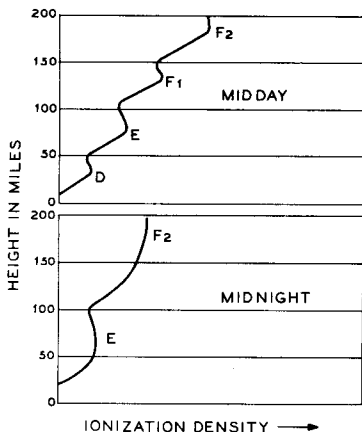

Figure 16

IONIZATION DENSITY IN THE IONOSPHERE

Showing typical ionization density of the ionosphere in mid-summer. Note that the F_1 and D layers disappear at night, and that the density of the E layer falls to such a low value that it is ineffective.

which the sky wave can undergo depends upon its frequency, and the amount of ionization in the ionosphere, which is in turn dependent upon radiation from the sun. The sun increases the density of the ionosphere layers (figure 16) and lowers their effective height. For this reason, the ionosphere acts very differently at different times of day, and at different times of the year.

The higher the frequency of a radio wave, the farther it penetrates the ionosphere, and the less it tends to be bent back toward the earth. The lower the frequency, the more easily the waves are bent, and the less they penetrate the ionosphere. 160-meter and 80-meter signals will usually be bent back to earth even when sent straight up, and may be considered as being *reflected* rather than *refracted*. As the frequency is raised beyond about 5,000 kc. (dependent upon the critical frequency of the ionosphere at the moment), it is found that waves transmitted at angles higher than a certain critical angle *never return to earth*. Thus, on the higher frequencies, it is necessary to confine radiation to low angles, since the high angle waves simply penetrate the ionosphere and are lost.

The F_2 Layer The higher of the two major reflection regions of the ionosphere is called the F_2 layer. This layer has

a virtual height of approximately 175 miles at night, and in the daytime it splits up into two layers, the upper one being called the F_2 layer and the lower being called the F_1 layer. The height of the F_2 layer during daylight hours is normally about 250 miles on the average and the F_1 layer often has a height of as low as 140 miles. It is the F_2 layer which supports all nighttime dx communication and nearly all daytime dx propagation.

The E Layer Below the F_2 layer is another layer, called the E layer, which is of importance in daytime communication over moderate distances in the frequency range between 3 and 8 Mc. This layer has an almost constant height at about 70 miles. Since the re-combination time of the ions at this height is rather short, the E layer disappears almost completely a short time after local sunset.

The D Layer Below the E layer at a height of about 35 miles is an *absorbing* layer, called the D layer, which exists in the middle of the day in the summertime. The layer also exists during midday in the winter time during periods of high solar activity, but the layer disappears completely at night. It is this layer which causes high absorption of signals in the medium and high-frequency range during the middle of the day.

Critical Frequency The *critical frequency* of an ionospheric layer is the highest frequency which will be reflected when the wave strikes the layer at vertical incidence. The critical frequency of the most highly ionized layer of the ionosphere may be as low as 2 Mc. at night and as high as 12 to 13 Mc. in the middle of the day. The critical frequency is directly of interest in that a *skip-distance zone* will exist on all frequencies *greater* than the highest critical frequency at that time. The critical frequency is a measure of the density of ionization of the reflecting layers. The higher the critical frequency the greater the density of ionization.

Maximum Usable Frequency The *maximum usable frequency* or *m.u.f.* is of great importance in long-distance communication since this frequency is the highest that can be used for communication *between any two specified areas*. The m.u.f. is the highest frequency at which a wave projected into space in a certain direction will be returned to earth in a specified region by ionospheric reflection. The m.u.f. is highest at noon or in the early afternoon and is highest in periods of greatest sunspot activity, often going to frequencies higher than 50 Mc. (figure 17).

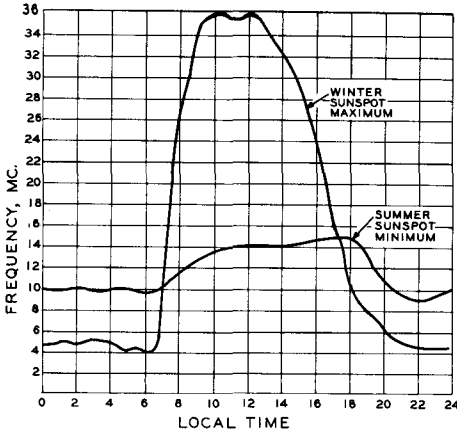

Figure 17
TYPICAL CURVES SHOWING CHANGE IN
M.U.F. AT MAXIMUM AND MINIMUM
POINTS IN SUNSPOT CYCLE

The m.u.f. often drops to frequencies below 10 Mc. in the early morning hours. The high m.u.f. in the middle of the day is brought about by reflection from the F_2 layer. M.u.f. data is published periodically in the magazines devoted to amateur work, and the m.u.f. can be calculated with the aid of *Basic Radio Propagation Predictions*, CRPL-D, published monthly by the Government Printing Office, Washington, D.C.

Absorption and Optimum Working Frequency The optimum working frequency for any particular direction and distance is usually about 15 per cent less than the m.u.f. for contact with that particular location. The absorption by the ionosphere becomes greater and greater as the operating frequency is progressively lowered below the m.u.f. It is this condition which causes signals to increase tremendously in strength on the 14-Mc. and 28-Mc. bands just before the signals drop completely out. At the time when the signals are greatest in amplitude the operating frequency is equal to the m.u.f. Then as the signals drop out the m.u.f. has become lower than the operating frequency.

Skip Distance The shortest distance from a transmitting location at which signals reflected from the ionosphere can be returned to the earth is called the *skip distance*. As was mentioned above under *Critical Frequency* there is no skip distance for a frequency below the critical frequency of the

most highly ionized layer of the ionosphere at the time of transmission. However, the skip distance is always present on the 14-Mc. band and is almost always present on the 3.5-Mc. and 7-Mc. bands at night. The actual measure of the skip distance is the distance between the point where the ground wave falls to zero and the point where the sky wave begins to return to earth. This distance may vary from 40 to 50 miles on the 3.5-Mc. band to thousands of miles on the 28-Mc. band.

The Sporadic-E Layer Occasional patches of extremely high ionization density appear at intervals throughout the year at a height approximately equal to that of the E layer. These patches, called the *sporadic-E* layer may be very small or may be up to several hundred miles in extent. The critical frequency of the *sporadic-E* layer may be greater than twice that of the normal ionosphere layers which exist at the same time.

It is this *sporadic-E* condition which provides "short-skip" contacts from 400 to perhaps 1200 miles on the 28-Mc. band in the evening. It is also the *sporadic-E* condition which provides the more common type of "band opening" experienced on the 50-Mc. band when very loud signals are received from stations from 400 to 1200 miles distant.

Cycles in Ionosphere Activity The ionization density of the ionosphere is determined by the amount of radiation (probably ultra violet) which is being received from the sun. Consequently, ionosphere activity is a function of the amount of radiation of the proper character being emitted by the sun and is also a function of the relative aspect of the regions in the vicinity of the location under discussion to the sun. There are four main cycles in ionosphere activity. These cycles are: the daily cycle which is brought about by the rotation of the earth, the 27-day cycle which is caused by the rotation of the sun, the seasonal cycle which is caused by the movement of the earth in its orbit, and the 11-year cycle which is a cycle in sunspot activity. The effects of these cycles are superimposed insofar as ionosphere activity is concerned. Also, the cycles are subject to short term variations as a result of magnetic storms and similar terrestrial disturbances.

The most recent minimum of the 11-year sunspot cycle occurred during the winter of 1954-1955, and we are currently moving up the slope of a new cycle, the maximum of which will probably occur during the year 1958. The current cycle is pictured in figure 18.

Fading The lower the angle of radiation of the wave, with respect to the hori-

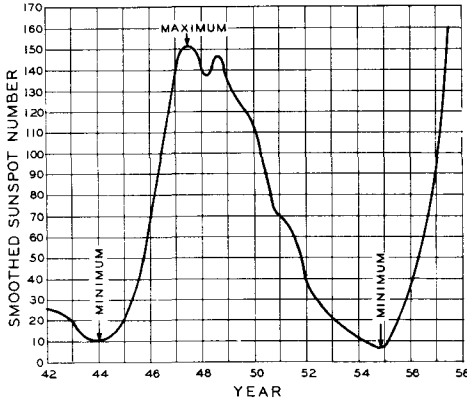

Figure 18
THE YEARLY TREND OF THE 11-YEAR SUNSPOT CYCLE. RADIO CONDITIONS IN GENERAL WILL IMPROVE DURING 1955-1958 AS THE CYCLE ADVANCES

zon, the farther away will the wave return to earth, and the greater the skip distance. The wave can be reflected back up into the ionosphere by the earth, and then be reflected back down again, causing a second skip distance area. The drawing of figure 19 shows the multiple reflections possible. When the receiver receives signals which have traveled over more than one path between transmitter and receiver, the signal impulses will not all arrive at the same instant, as they do not all travel the same distance. When two or more signals arrive in the same phase at the receiving antenna, the resulting signal in the receiver will be quite strong. On the other hand, if the signals arrive 180° out of phase, so they tend to cancel each other, the received signal will drop—perhaps to zero if perfect cancellation occurs. This explains why high-frequency signals are subject to fading.

Fading can be greatly reduced on the high frequencies by using a transmitting antenna with sharp vertical directivity, thus cutting down the number of possible paths of signal arrival. A receiving antenna with similar characteristics (sharp vertical directivity) will further reduce fading. It is desirable, when using antennas with sharp vertical directivity, to use the lowest vertical angle consistent with good signal strength for the frequency used.

Scattered Reflections Scattered reflections are random, diffused, substantially isotropic reflections which are partly re-

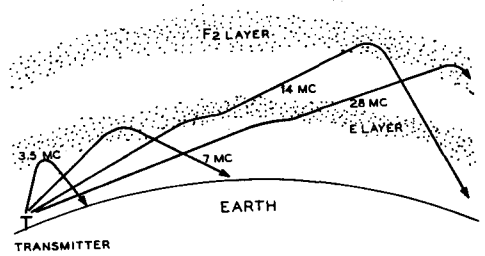

Figure 19
IONOSPHERE-REFLECTION WAVE PATHS

Showing typical ionosphere-reflection wave paths during daylight hours when ionization density is such that frequencies as high as 28 Mc. will be returned to earth. The distance between ground-wave range and that range where the ionosphere-reflected wave of a specific frequency first will be returned to earth is called the skip distance.

sponsible for reception within the skip zone, and for reception of signals from directions off the great circle path.

In a heavy fog or mist, it is difficult to see the road at night because of the bright glare caused by scattered reflection of the headlight beam by the minute droplets. In fact, the road directly to the side of the car will be weakly illuminated under these conditions, whereas it would not on a clear night (assuming flat, open country). This is a good example of propagation of waves by scattered reflections into a zone which otherwise would not be illuminated.

Scattering occurs in the ionosphere at all times, because of irregularities in the medium (which result in "patches" corresponding to the water droplets) and because of random-phase radiation due to the collision or recombination of free electrons. However, the nature of the scattering varies widely with time, in a random fashion. Scattering is particularly prevalent in the E region, but scattered reflections may occur at any height, even well out beyond the virtual height of the F_2 layer.

There is no "critical frequency" or "lowest perforating frequency" involved in the scattering mechanism, though the intensity of the scattered reflections due to typical scattering in the E region of the ionosphere decreases with frequency.

When the received signal is due primarily to scattered reflections, as is the case in the skip zone or where the great circle path does not provide a direct sky wave (due to low critical or perforation frequency, or to an ionosphere storm) very bad distortion will be evi-

dent, particularly a "flutter fade" and a characteristic "hollow" or echo effect.

Deviations from a great circle path are especially noticeable in the case of great circle paths which cross or pass near the auroral zones, because in such cases there often is complete or nearly complete absorption of the direct sky wave, leaving off-path scattered reflections the only mechanism of propagation. Under such conditions the predominant wave will appear to arrive from a direction closer to the equator, and the signal will be noticeably if not considerably weaker than a direct sky wave which is received under favorable conditions.

Irregular reflection of radio waves from "scattering patches" is divided into two categories: "short scatter" and "long scatter".

Short scatter is the scattering that occurs when a radio wave first reaches the scattering patches or media. Ordinarily it is of no particular benefit, as in most cases it only serves to fill in the inner portion of the skip zone with a weak, distorted signal.

Long scatter occurs when a wave has been refracted from the F_2 layer and strikes scattering patches or media on the way down. When the skip distance exceeds several hundred miles, long scatter is primarily responsible for reception within the skip zone, particularly the outer portion of the skip zone. Distortion is much less severe than in the case of short scatter, and while the signal is likewise weak, it sometimes can be utilized for satisfactory communication.

During a severe ionosphere disturbance in the north auroral zone, it sometimes is possible to maintain communication between the Eastern United States and Northern Europe by the following mechanism: That portion of the energy which is radiated in the direction of the great circle path is completely absorbed upon reaching the auroral zone. However, the portion of the wave leaving the United States in a *southeasterly* direction is refracted downward from the F_2 layer and encounters scattering patches or media on its downward trip at a distance of approximately 2000 miles from the transmitter. There it is reflected by "long scatter" in all directions, this scattering region acting like an isotropic radiator fed with a very small fraction of the original transmitter power. The great circle path from this southerly point to northern Europe does not encounter unfavorable ionosphere conditions, and the wave is propagated the rest of the trip as though it had been radiated from the scattering region.

Another type of scatter is produced when a sky wave strikes certain areas of the earth. Upon striking a comparatively smooth surface such as the sea, there is little scattering, the wave being shot up again by what could be

considered specular or mirror reflection. But upon striking a mountain range, for instance, the reradiation or reflected energy is scattered, some of it being directed back towards the transmitter, thus providing another mechanism for producing a signal within the skip zone.

Meteors and "Bursts" When a meteor strikes the earth's atmosphere, a cylindrical region of free electrons is formed at approximately the height of the E layer. This slender ionized column is quite long, and when first formed is sufficiently dense to reflect radio waves back to earth most readily, *including v-b-f waves which are not ordinarily returned by the F_2 layer.*

The effect of a single meteor, of normal size, shows up as a sudden "burst" of signal of short duration at points not ordinarily reached by the transmitter. After a period of from 10 to 40 seconds, recombination and diffusion have progressed to the point where the effect of a *single* fairly large meteor is not perceptible. However, there are many *small* meteors impinging upon earth's atmosphere every minute, and the *aggregate* effect of their transient ionized trails, including the small amount of residual ionization that exists for several minutes after the original flash but is too weak and dispersed to prolong a "burst", is believed to contribute to the existence of the "nighttime E" layer, and perhaps also to sporadic E patches.

While there are many of these very small meteors striking the earth's atmosphere every minute, meteors of normal size (sufficiently large to produce individual "bursts") do not strike nearly so frequently except during some of the comparatively rare meteor "showers". During one of these displays a "quivering" ionized layer is produced which is intense enough to return signals in the lower v-h-f range with good strength, but with a type of "flutter" distortion which is characteristic of this type of propagation.

21-9 Transmission Lines

For many reasons it is desirable to place an antenna or radiating system as high and in the clear as is physically possible, utilizing some form of nonradiating transmission line to carry energy with as little loss as possible from the transmitter to the radiating antenna, and conversely from the antenna to the receiver.

There are many different types of transmission lines and, generally speaking, practically any type of transmission line or feeder system may be used with any type of antenna. How-

ever, mechanical or electrical considerations often make one type of transmission line better adapted for use to feed a particular type of antenna than any other type.

Transmission lines for carrying r-f energy are of two general types: *non-resonant* and *resonant*. A non-resonant transmission line is one on which a successful effort has been made to eliminate reflections from the termination (the antenna in the transmitting case and the receiver for a receiving antenna) and hence one on which standing waves do not exist or are relatively small in magnitude. A resonant line, on the other hand, is a transmission line on which standing waves of appreciable magnitude do appear, either through inability to match the characteristic impedance of the line to the termination or through intentional design.

The principal types of transmission line in use or available at this time include the open-wire line (two-wire and four-wire types), two-wire solid-dielectric line ("Twin-Lead" and similar ribbon or tubular types), two-wire polyethylene-filled shielded line, coaxial line of the solid-dielectric, beaded, stub-supported, or pressurized type, rectangular and cylindrical wave guide, and the single-wire feeder operated against ground. The significant characteristics of the more popular types of transmission line available at this time are given in the chart of figure 21.

21-10 Non-Resonant Transmission Lines

A non-resonant or untuned transmission line is a line with negligible standing waves. Hence, a non-resonant line is a line carrying r-f power only in one direction—from the source of energy to the load.

Physically, the line itself should be *identical throughout its length*. There will be a smooth distribution of voltage and current throughout its length, both tapering off very slightly towards the load end of the line as a result of line losses. The attenuation (loss) in certain types of untuned lines can be kept very low for line lengths up to several thousand feet. In other types, particularly where the dielectric is not air (such as in the twisted-pair line), the losses may become excessive at the higher frequencies, unless the line is relatively short.

Transmission-Line Impedance All transmission lines have distributed inductance, capacitance and resistance. Neglecting the resistance, as it is of minor importance in short lines, it is found

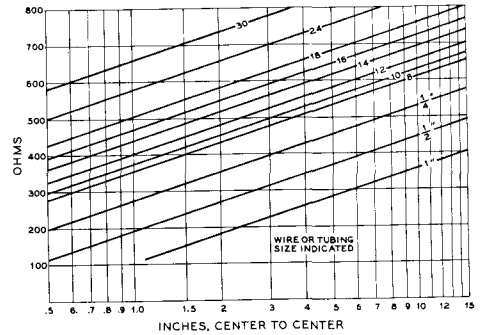

Figure 20
CHARACTERISTIC IMPEDANCE OF TYPICAL TWO-WIRE OPEN LINES

that the *inductance and capacitance per unit length* determine the characteristic or surge impedance of the line. Thus, the surge impedance depends upon the nature and spacing of the conductors, and the dielectric separating them.

Speaking in electrical terms, the characteristic impedance of a transmission line is simply the ratio of the voltage across the line to the current which is flowing, the same as is the case with a simple resistor: $Z_0 = E/I$. Also, in a substantially loss-less line (one whose attenuation per wavelength is small) the energy stored in the line will be equally divided between the capacitive field and the inductive field which serve to propagate the energy along the line. Hence the characteristic impedance of a line may be expressed as:

$$Z_0 = \sqrt{L/C}$$

Two-Wire Open Line A two-wire transmission system is easy to construct. Its surge impedance can be calculated quite easily, and when properly adjusted and balanced to ground, with a conductor spacing which is negligible in terms of the wavelength of the signal carried, undesirable feeder radiation is minimized; the current flow in the adjacent wires is in opposite directions, and the magnetic fields of the two wires are in opposition to each other. When a two-wire line is terminated with the equivalent of a pure resistance equal to the characteristic impedance of the line, the line becomes a non-resonant line.

Expressed in physical terms, the characteristic impedance of a two-wire open line is equal to:

CHARACTERISTICS OF COMMON TRANSMISSION LINES

	ATTENUATION db/100 FEET VSWR = 1.0			VELO- CITY FACTOR V	WJJD PER FT.	REMARKS
	30 MC	100 MC	300 MC			
OPEN WIRE LINE, N° 12 COPPER.	0.15	0.3	0.8	0.96-0.99	—	BASED UPON 4" SPACING BELOW 50 MC.; 2" SPACING ABOVE 50 MC. RADIATION LOSSES INCLUDED. CLEAN, LOW LOSS CERAMIC INSULATION ASSUMED. RADIATION HIGH ABOVE 150 MC.
RIBBON LINE, REC. TYPE 300 OHMS (7/28 CONDUCTORS)	0.66	2.2	5.3	0.82	8	FOR CLEAN, DRY LINE. WET WEATHER PERFORMANCE RATHER POOR. BEST LINE IS SLIGHTLY CONVEX. AVOID LINE THAT HAS CONCAVE DIELECTRIC. SUITABLE FOR LOW POWER TRANSMITTING APPLICATIONS. LOSSES INCREASE AS LINE WEATHERS. HANDLES 400 WATTS AT 30 MC. IF VSWR IS LOW.
TUBULAR "TWIN-LEAD" REC. TYPE, 300 OHMS, 5/16" O.D., (AMPHENOL TYPE 14-271)	—	—	—	—	—	CHARACTERISTICS SIMILAR TO RECEIVING TYPE RIBBON LINE EXCEPT FOR MUCH BETTER WET WEATHER PERFORMANCE.
RIBBON LINE, TRANS. TYPE, 300 OHMS.	—	—	—	—	—	CHARACTERISTICS VARY SOMEWHAT WITH MANUFACTURER, BUT APPROXIMATE THOSE OF RECEIVING TYPE RIBBON EXCEPT FOR GREATER POWER HANDLING CAPABILITY AND SLIGHTLY BETTER WET WEATHER PERFORMANCE.
TUBULAR "TWIN-LEAD" TRANS. TYPE, 7/16 O.D. (AMPHENOL 14-076)	0.65	2.3	5.4	0.79	6.1	FOR USE WHERE RECEIVING TYPE TUBULAR "TWIN-LEAD" DOES NOT HAVE SUFFICIENT POWER HANDLING CAPABILITY. WILL HANDLE 1 KW AT 30 MC. IF VSWR IS LOW.
RIBBON LINE, RECEIVE. TYPE, 150 OHMS.	1.1	2.7	6.0	0.77	10	USEFUL FOR QUARTER WAVE MATCHING SECTIONS. NO LONGER WIDELY USED AS A LINE.
RIBBON LINE, RECEIVE. TYPE, 75 OHMS.	2.0	5.0	11.0	0.66	19	USEFUL MAINLY IN THE H-F RANGE BECAUSE OF EXCESSIVE LOSSES AT V-H-F AND U-H-F. LESS AFFECTED BY WEATHER THAN 300 OHM RIBBON.
RIBBON LINE, TRANS. TYPE, 75 OHMS.	1.5	3.9	8.0	0.71	18	VERY SATISFACTORY FOR TRANSMITTING APPLICATIONS BELOW 30 MC. AT POWERS UP TO 1 KW. NOT SIGNIFICANTLY AFFECTED BY WET WEATHER.
RG-8/U COAX (52 OHMS)	1.0	2.1	4.2	0.66	29.5	WILL HANDLE 2 KW AT 30 MC. IF VSWR IS LOW. 0.4" O.D. 7/21 CONDUCTOR.
RG-11/U COAX (75 OHMS)	0.94	1.9	3.8	0.66	20.5	WILL HANDLE 1.4 KW AT 30 MC. IF VSWR IS LOW. 0.4" O.D. 7/28 CONDUCTOR.
RG-17/U COAX (52 OHMS)	0.38	0.65	1.6	0.66	29.5	WILL HANDLE 7.6 KW. AT 30 MC. IF VSWR IS LOW. 0.87" O.D. 0.19" DIA. CONDUCTOR
RG-58/U COAX (53 OHMS)	1.95	4.1	8.0	0.66	28.5	WILL HANDLE 430 WATTS AT 30 MC. IF VSWR IS LOW. 0.2" O.D. N° 20 CONDUCTOR.
RG-59/U COAX (73 OHMS)	1.9	3.8	7.0	0.66	21	WILL HANDLE 680 WATTS AT 30 MC. IF VSWR IS LOW. 0.24" O.D. N° 22 CONDUCTOR.
TV-59 COAX (72 OHMS)	2.0	4.0	7.0	0.66	22	*COMMERCIAL* VERSION OF RG-59/U FOR LESS EXACTING APPLICATIONS. LESS EXPENSIVE.
RG-22/U SHIELDED PAIR (93 OHMS)	1.7	3.0	5.5	0.66	16	FOR SHIELDED, BALANCED-TO-GROUND APPLICATIONS. VERY LOW NOISE PICK UP. 0.4" O.D.
K-111 SHIELDED PAIR (300 OHMS)	2.0	3.5	6.1	—	4	DESIGNED FOR TV LEAD-IN IN NOISY LOCATIONS. LOSSES HIGHER THAN REGULAR 300 OHM RIBBON, BUT DO NOT INCREASE AS MUCH FROM WEATHERING.

∇ APPROXIMATE. EXACT FIGURE VARIES SLIGHTLY WITH MANUFACTURER.

FIGURE 21

$$Z_0 = 276 \log_{10} \frac{2S}{d}$$

Where:

S is the exact distance between wire centers in some convenient unit of measurement, and d is the diameter of the wire measured in the same units as the wire spacing, S.

Since $\frac{2S}{d}$ expresses a ratio only, the units of measurement may be centimeters, millimeters, or inches. This makes no difference in the answer, so long as the substituted values for S and d are in the same units.

The equation is accurate so long as the wire spacing is relatively large as compared to the wire diameter.

Surge impedance values of less than 200 ohms are seldom used in the open-type two-wire line, and, even at this rather high value of Z_0 the wire spacing S is uncomfortably close, being only 5.3 times the wire diameter d.

Figure 20 gives in graphical form the surge impedance of practicable two-wire lines. The chart is self-explanatory, and is sufficiently accurate for practical purposes.

Ribbon and Tubular Transmission Line Instead of using spacer insulators placed periodically along the transmission line it is possible to mold the line conductors into a ribbon or tube of flexible low-loss dielectric material. Such line, with polyethylene dielectric, is used in enormous quantities as the lead-in transmission line for FM and TV receivers. The line is available from several manufacturers in the

ribbon and tubular configuration, with characteristic impedance values from 75 to 300 ohms. Receiving types, and transmitting types for power levels up to one kilowatt in the h-f range, are listed with their pertinent characteristics, in the table of figure 21.

Coaxial Line Several types of coaxial cable have come into wide use for feeding power to an antenna system. A cross-sectional view of a coaxial cable (sometimes called concentric cable or line) is shown in figure 22.

As in the parallel-wire line, the power lost in a properly terminated coaxial line is the sum of the effective resistance losses along the length of the cable and the dielectric losses between the two conductors.

Of the two losses, the effective resistance loss is the greater; since it is largely due to the skin effect, the line loss (all other conditions the same) will increase directly as the square root of the frequency.

Figure 22 shows that, instead of having two conductors running side by side, one of the conductors is placed *inside* of the other. Since the outside conductor completely shields the inner one, no radiation takes place. The conductors may both be tubes, one within the other; the line may consist of a solid wire within a tube, or it may consist of a stranded or solid inner conductor with the outer conductor made up of one or two wraps of copper shielding braid.

In the type of cable most popular for military and non-commercial use the inner conductor consists of a heavy stranded wire, the outer conductor consists of a braid of copper wire, and the inner conductor is supported within the outer by means of a semi-solid dielectric of exceedingly low loss characteristics called polyethylene. The Army-Navy designation on one size of this cable suitable for power levels up to one kilowatt at frequencies as high as 30 Mc. is AN/RG-8/U. The outside diameter of this type of cable is approximately one-half inch. The characteristic impedance of this cable type is 52 ohms, but other similar types of greater and smaller power-handling capacity are available in impedances of 52, 75, and 95 ohms.

When using solid dielectric coaxial cable it is necessary that precautions be taken to insure that moisture cannot enter the line. If the better grade of connectors manufactured for the line are employed as terminations, this condition is automatically satisfied. If connectors are not used, it is necessary that some type of moisture-proof sealing compound be applied to the end of the cable where it will be exposed to the weather.

Nearby metallic objects cause no loss, and coaxial cable may be run up air ducts or ele-

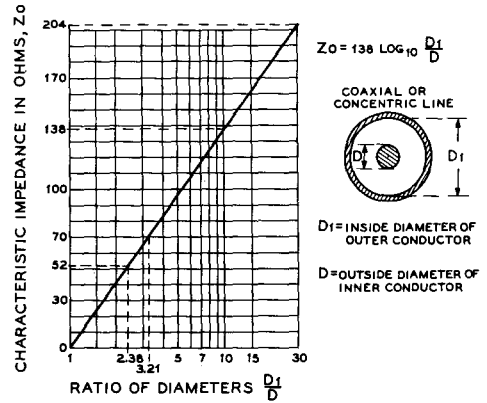

Figure 22
CHARACTERISTIC IMPEDANCE OF AIR-FILLED COAXIAL LINES

If the filling of the line is a dielectric material other than air, the characteristic impedance of the line will be reduced by a factor proportional to the square-root of the dielectric constant of the material used as a dielectric within the line.

vator shafts, inside walls, or through metal conduit. Insulation troubles can be forgotten. The coaxial cable may be buried in the ground or suspended above ground.

Standing Waves Standing waves on a transmission line *always* are the result of the reflection of energy. The only significant reflection which takes place in a normal installation is that at the load end of the line. But reflection can take place from discontinuities in the line, such as caused by insulators, bends, or metallic objects adjacent to an unshielded line.

When a uniform transmission line is terminated in an impedance equal to its surge impedance, reflection of energy does not occur, and no standing waves are present. When the load termination is exactly the same as the line impedance, it simply means that the load takes energy from the line just as fast as the line delivers it, no slower and no faster.

Thus, for proper operation of an untuned line (with standing waves eliminated), some form of impedance-matching arrangement must be used between the transmission line and the antenna, so that the radiation resistance of the antenna is reflected back into the line as a nonreactive impedance equal to the line impedance.

The termination at the antenna end is the only critical characteristic about the untuned

line fed by a transmitter. It is the reflection from the antenna end which starts waves moving back toward the transmitter end. When waves moving in both directions along a conductor meet, standing waves are set up.

Semi-Resonant Parallel-Wire Lines A well-constructed open wire line has acceptably low losses when its length is less than about two wavelengths even when the voltage standing-wave ratio is as high as 10 to 1. A transmission line constructed of ribbon or tubular line, however, should have the standing-wave ratio kept down to not more than about 3 to 1 both to reduce power loss and because the energy dissipation on the line will be localized, causing overheating of the line at the points of maximum current.

Because moderate standing waves can be tolerated on open-wire lines without much loss, a standing-wave ratio of 2/1 or 3/1 is considered acceptable with this type of line, *even when used in an untuned system*. Strictly speaking, a line is untuned, or non-resonant, only when it is perfectly flat, with a standing-wave ratio of 1 (no standing waves). However, some mismatch can be tolerated with open-wire untuned lines, so long as the reactance is not objectionable, or is eliminated by cutting the line to approximately resonant length.

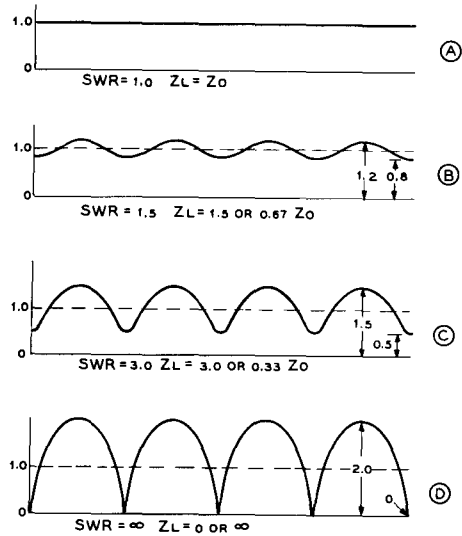
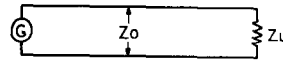

Figure 23
STANDING WAVES ON A TRANSMISSION LINE

As shown at (A), the voltage and current are constant on a transmission line which is terminated in its characteristic impedance, assuming that losses are small enough so that they may be neglected. (B) shows the variation in current or in voltage on a line terminated in a load with a reflection coefficient of 0.2 so that a standing wave ratio of 1.5 to 1 is set up. At (C) the reflection coefficient has been increased to 0.5, with the formation of a 3 to 1 standing-wave ratio on the line. At (D) the line has been terminated in a load which has a reflection coefficient of 1.0 (short, open circuit, or a pure reactance) so that all the energy is reflected with the formation of an infinite standing-wave ratio.

21-11 Tuned or Resonant Lines

If a transmission line is terminated in its *characteristic surge impedance*, there will be no reflection at the end of the line, and the current and voltage distribution will be uniform along the line. If the end of the line is either open-circuited or short-circuited, the reflection at the end of the line will be 100 per cent, and *standing waves* of very great amplitude will appear on the line. There will still be practically no radiation from the line if it is closely spaced, but voltage nodes will be found every half wavelength, the voltage loops corresponding to current nodes (figure 23).

If the line is terminated in some value of resistance other than the characteristic surge impedance, there will be some reflection, the amount being determined by the amount of mismatch. With reflection, there will be standing waves (excursions of current and voltage) along the line, though not to the same extent as with an open-circuited or short-circuited line. The current and voltage loops will occur at the same *points* along the line as with the open or short-circuited line, and as the terminating impedance is made to approach the characteristic impedance of the line, the cur-

rent and voltage along the line will become more uniform. The foregoing assumes, of course, a purely resistive (non-reactive) load. If the load is reactive, standing waves also will be formed. But with a reactive load the nodes will occur at different locations from the node locations encountered with wrong-value resistive termination.

A well built 500- to 600-ohm transmission line may be used as a resonant feeder for lengths up to several hundred feet with very low loss, so long as the amplitude of the standing waves (ratio of maximum to minimum voltage along the line) is *not too great*. The

amplitude, in turn, depends upon the mismatch at the line termination. A line of no. 12 wire, spaced 6 inches with good ceramic or plastic spreaders, has a surge impedance of approximately 600 ohms, and makes an excellent tuned feeder for feeding anything between 60 and 6000 ohms (at frequencies below 30 Mc.). If used to feed a load of higher or lower impedance than this, the standing waves become great enough in amplitude that some loss will occur unless the feeder is kept short. At frequencies above 30 Mc., the spacing becomes an appreciable fraction of a wavelength, and radiation from the line no longer is negligible. Hence, coaxial line or close-spaced parallel-wire line is recommended for v-h-f work.

If a transmission line is not perfectly matched, it should be made *resonant*, even though the amplitude of the standing waves (voltage variation) is not particularly great. This prevents reactance from being coupled into the final amplifier. A feed system having moderate standing waves may be made to present a non-reactive load to the amplifier either by tuning or by pruning the feeders to approximate resonance.

Usually it is preferable with tuned feeders to have a current loop (voltage minimum) at the transmitter end of the line. This means that when voltage-feeding an antenna, the tuned feeders should be made an odd number of quarter wavelengths long, and when current-feeding an antenna, the feeders should be made an even number of quarter wavelengths long. Actually, the feeders are made about 10 per cent of a quarter wave longer than the calculated value (the value given in the tables) when they are to be series tuned to resonance by means of a capacitor, instead of being trimmed and pruned to resonance.

When tuned feeders are used to feed an antenna on more than one band, it is necessary to compromise and make provision for both series and parallel tuning, inasmuch as it is impossible to cut a feeder to a length that will be optimum for several bands. If a voltage loop appears at the transmitter end of the line on certain bands, parallel tuning of the feeders will be required in order to get a transfer of energy. It is impossible to transfer energy by inductive coupling unless current is flowing. This is effected at a voltage loop by the

presence of the resonant tank circuit formed by parallel tuning of the antenna coil.

21-12 Line Discontinuities

In the previous discussion we have assumed a transmission line which was uniform throughout its length. In actual practice, this is usually not the case.

Whenever there is any sudden change in the characteristic impedance of the line, partial reflection will occur at the point of discontinuity. Some of the energy will be transmitted and some reflected, which is essentially the same as having some of the energy absorbed and some reflected in so far as the effect upon the line from the generator to that point is concerned. The discontinuity can be ascribed a reflection coefficient just as in the case of an unmatched load.

In a simple case, such as a finite length of uniform line having a characteristic impedance of 500 ohms feeding into an infinite length of uniform line having a characteristic impedance of 100 ohms, the behavior is easily predicted. The infinite 100 ohm line will have no standing waves and will accept the same power from the 500 ohm line as would a 100 ohm resistor, and the rest of the energy will be reflected at the discontinuity to produce standing waves from there back to the generator. However, in the case of a complex discontinuity placed at an odd distance down a line terminated in a complex impedance, the picture becomes complicated, especially when the discontinuity is neither sudden nor gradual, but intermediate between the two. This is the usual case with amateur lines that must be erected around buildings and trees.

In any case, when a discontinuity exists somewhere on a line and is not a smooth, gradual change embracing several wavelengths, it is not possible to avoid standing waves throughout the entire length of the line. If the discontinuity is sharp enough and is great enough to be significant, standing waves must exist on one side of the discontinuity, and may exist on both sides in many cases.

Antennas and Antenna Matching

Antennas for the lower frequency portion of the h-f spectrum (perhaps from 1.8 to 7.0 Mc.), and temporary or limited use antennas for the upper portion of the h-f range, usually are of a relatively simple type in which directivity is not a prime consideration. Also, it often is desirable, in amateur work, that a single antenna system be capable of operation at least on the 3.5-Mc. and 7.0-Mc. range, and preferably on other frequency ranges. Consequently, the first portion of this chapter will be devoted to a discussion of such antenna systems. The latter portion of the chapter is devoted to the general problem of matching the antenna transmission line to antenna systems of the fixed type. Matching the antenna transmission line to the rotatable directive array is discussed in Chapter Twenty-five.

22-1 End-Fed Half-Wave Horizontal Antennas

The half-wave horizontal dipole is the most common and the most practical antenna for the 3.5-Mc. and 7-Mc. amateur bands. The form of the dipole, and the manner in which it is fed are capable of a large number of variations. Figure 2 shows a number of practicable forms of the simple dipole antenna along with methods of feed.

Usually a high-frequency doublet is mounted as high and as much in the clear as possible, for obvious reasons. However, it is sometimes justifiable to bring part of the radiating system directly to the transmitter, feeding the antenna without benefit of a transmission line. This is permissible when (1) there is insufficient room to erect a 75- or 80-meter horizontal dipole and feed line, (2) when a long wire is also to be operated on one of the higher frequency bands on a harmonic. In either case, it is usually possible to get the main portion of the antenna in the clear because of its length. This means that the power lost by bringing the antenna directly to the transmitter is relatively small.

Even so, it is not best practice to bring the high-voltage end of an antenna into the operating room because of the increased difficulty in eliminating BCI and TVI. For this reason one should dispense with a feed line in conjunction with a Hertz antenna only as a last resort.

End-Fed Antennas The end-fed antenna has no form of transmission line to couple it to the transmitter, but brings the radiating portion of the antenna right down to the transmitter, where some form of coupling system is used to transfer energy to the antenna.

Figure 1 shows two common methods of feeding the *Fuchs antenna* or *end-fed Hertz*.

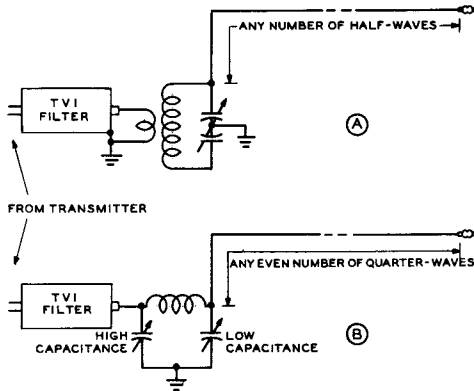

Figure 1

THE END-FED HERTZ ANTENNA

Showing the manner in which an end-fed Hertz antenna may be fed through a low-impedance line and low-pass filter by using a resonant tank circuit as at (A), or through the use of a reverse-connected pi network as at (B).

Some harmonic-attenuating provision (in addition to the usual low-pass TVI filter) must be included in the coupling system, as an end-fed antenna itself offers no discrimination against harmonics, either odd or even.

The end-fed Hertz antenna has rather high losses unless at least three-quarters of the radiator can be placed outside the operating room and in the clear. As there is r-f voltage at the point where the antenna enters the operating room, the insulation at that point should be several times as effective as the insulation commonly used with low-voltage feeder systems. This antenna can be operated on all of its higher harmonics with good efficiency, and can be operated at half frequency against ground as a quarter-wave Marconi.

As the frequency of an antenna is raised slightly when it is bent anywhere except at a voltage or current loop, an end-fed Hertz antenna usually is a few per cent longer than a straight half-wave doublet for the same frequency, because, ordinarily, it is impractical to bring a wire in to the transmitter without making several bends.

The Zepp Antenna System The *zeppelin* or *zepp antenna system*, illustrated in figure 2A is very convenient when it is desired to operate a single radiating wire on a number of harmonically related frequencies.

The zepp antenna system is easy to tune, and can be used on several bands by merely

retuning the feeders. The overall efficiency of the zepp antenna system is not quite as high for long feeder lengths as for some of the antenna systems which employ non-resonant transmission lines, but where space is limited and where operation on more than one band is desired, the zepp has some decided advantages.

As the radiating portion of the zepp antenna system must always be some multiple of a half wave long, there is always high voltage present at the point where the live zepp feeder attaches to the end of the radiating portion of the antenna. Thus, this type of zepp antenna system is *voltage fed*.

Stub-Fed Zepp-Type Radiator Figure 2C shows a modification of the zepp-type antenna system to allow the use of a non-resonant transmission line between the radiating portion of the antenna and the transmitter. The *zepp* portion of the antenna is resonated as a quarter-wave stub and the non-resonant feeders are connected to the stub at a point where standing waves on the feeder are minimized. The procedure for making these adjustments is described in detail in Section 22-8 This type of antenna system is quite satisfactory when it is necessary physically to end feed the antenna, but where it is necessary also to use non-resonant feeder between the transmitter and the radiating system.

22-2 Center-Fed Half-Wave Horizontal Antennas

The center feeding of a half-wave antenna system is usually to be desired over an end-fed system since the center-fed system is inherently balanced to ground and is therefore less likely to be troubled by feeder radiation. A number of center-fed systems are illustrated in figure 2.

The Tuned Doublet The current-fed doublet with spaced feeders, sometimes called a *center-fed zepp*, is an inherently balanced system if the two legs of the radiator are electrically equal. This fact holds true regardless of the frequency, or of the harmonic, on which the system is operated. The system can successfully be operated over a wide range of frequencies if the system as a whole (both tuned feeders and the center-fed flat top) can be resonated to the operating frequency. It is usually possible to tune such an antenna system to resonance with the aid of a tapped coil and a tuning capacitor that can optionally be placed either

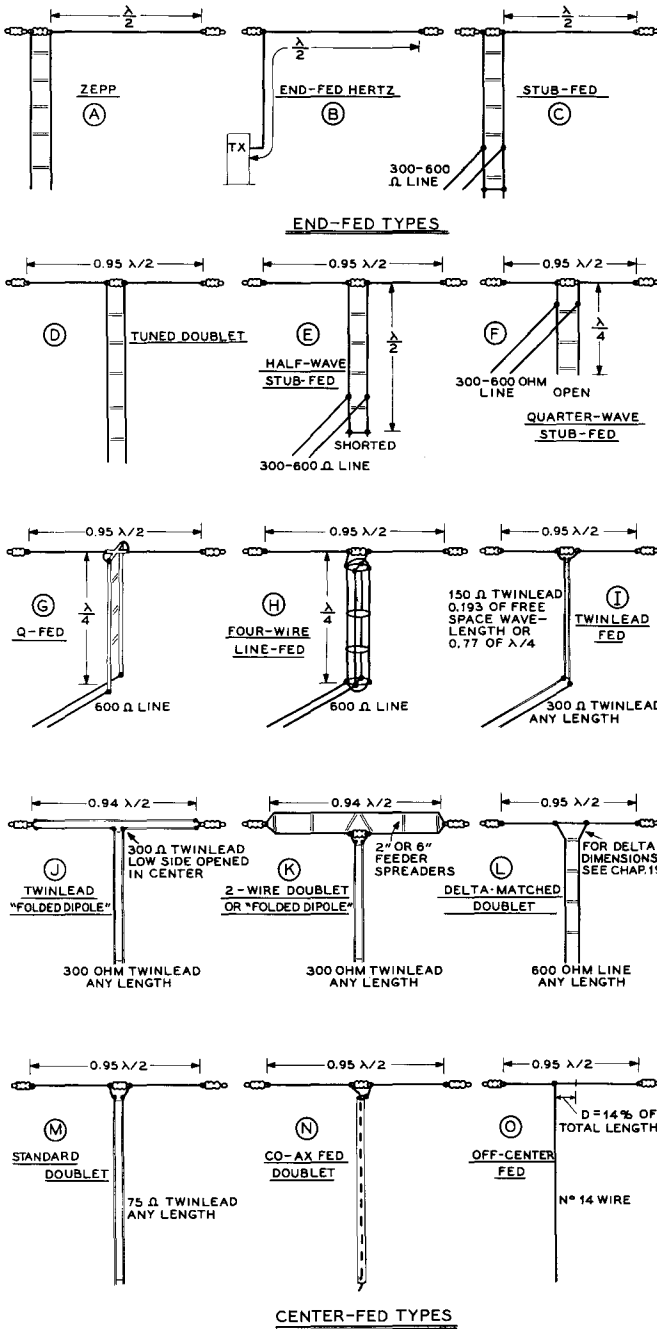

Figure 2
ALTERNATIVE
METHODS OF
FEEDING A
HALF-WAVE DIPOLE

in series with the antenna coil or in parallel with it. A series tuning capacitor can be placed in series with one feeder leg without unbalancing the system.

The tuned-doublet antenna is shown in figure 2D. The antenna is a current-fed system when the radiating wire is a half wave long electrically, or when the system is operated on its odd harmonics, but becomes a voltage-fed radiator when operated on its even harmonics.

The antenna has a different radiation pattern when operated on its harmonics, as would be expected. The arrangement used on the second harmonic is better known as the *Franklin colinear array* and is described in Chapter Twenty-three. The pattern is similar to a $\frac{1}{2}$ -wave dipole except that it is sharper in the broadside direction. On higher harmonics of operation there will be multiple lobes of radiation from the system.

Figures 2E and 2F show alternative arrangements for using an untuned transmission line between the transmitter and the tuned-doublet radiator. In figure 2E a half-wave shorted line is used to resonate the radiating system, while in figure 2F a quarter-wave open line is utilized. The adjustment of quarter-wave and half-wave stubs is discussed in Section 19-8.

Doublets with Quarter-Wave Transformers The average value of feed impedance for a center-fed half-wave doublet is 75 ohms. The actual value varies with height and is shown in Chapter Twenty-one. Other methods of matching this rather low value of impedance to a medium-impedance transmission line are shown in (G), (H), and (I) of figure 2. Each of these three systems uses a quarter-wave transformer to accomplish the impedance transformation. The only difference between the three systems lies in the type of transmission line used in the quarter-wave transformer. (G) shows the *Johnson Q system* whereby a line made up of $\frac{1}{2}$ -inch dural tubing is used for the low-impedance linear transformer. A line made up in this manner is frequently called a set of *Q bars*. Illustration (H) shows the use of a four-wire line as the linear transformer, and (I) shows the use of a piece of 150-ohm Twin-Lead electrically $\frac{1}{4}$ -wave in length as the transformer between the center of the dipole and a piece of 300-ohm Twin-Lead. In any case the impedance of the quarter-wave transformer will be of the order of 150 to 200 ohms. The use of sections of transmission line as linear transformers is discussed in detail in Section 22-8.

Multi-Wire Doublets An alternative method for increasing the feed-point impedance of a dipole so that a medium-imped-

ance transmission line may be used is shown in figures 2J and 2K. This system utilizes more than one wire in parallel for the radiating element, but only one of the wires is broken for attachment of the feeder. The most common arrangement uses two wires in the flat top of the antenna so that an impedance multiplication of four is obtained.

The antenna shown in figure 2J is the so-called *Twin-Lead folded dipole* which is a commonly used antenna system on the medium-frequency amateur bands. In this arrangement both the antenna and the transmission line to the transmitter are constructed of 300-ohm Twin-Lead. The flat top of the antenna is made slightly less than the conventional length ($462/F_{Mc}$, instead of $468/F_{Mc}$, for a single-wire flat top) and the two ends of the Twin-Lead are joined together at each end. The center of one of the conductors of the Twin-Lead flat top is broken and the two ends of the Twin-Lead feeder are spliced into the flat top leads. As a protection against moisture pieces of flat polyethylene taken from another piece of 300-ohm Twin-Lead may be molded over the joint between conductors with the aid of an electric iron or soldering iron.

Better bandwidth characteristics can be obtained with a folded dipole made of ribbon line if the two conductors of the ribbon line are shorted a distance of 0.82 (the velocity factor of ribbon line) of a free-space quarter wavelength from the center or feed point. This procedure is illustrated in figure 3A. An alternative arrangement for a Twin-Lead folded dipole is illustrated in figure 3B. This type of half-wave antenna system is convenient for use on the 3.5-Mc. band when the 116 to 132 foot distance required for a full half-wave is not quite available in a straight line, since the single-wire end pieces may be bent away or downward from the direction of the main section of the antenna.

Figure 2K shows the basic type of 2-wire doublet or *folded dipole* wherein the radiating section of the system is made up of standard antenna wire spaced by means of feeder spreaders. The feeder again is made of 300-ohm Twin-Lead since the feed-point impedance is approximately 300 ohms, the same as that of the Twin-Lead folded dipole.

The folded-dipole type of antenna has the broadest response characteristic (greatest bandwidth) of any of the conventional half-wave antenna systems constructed of small wires or conductors. Hence such an antenna may be operated over the greatest frequency range without serious standing waves of any common half-wave antenna type.

The increased bandwidth of the multi-wire doublet type of radiator, and the fact that the feed-point resistance is increased several

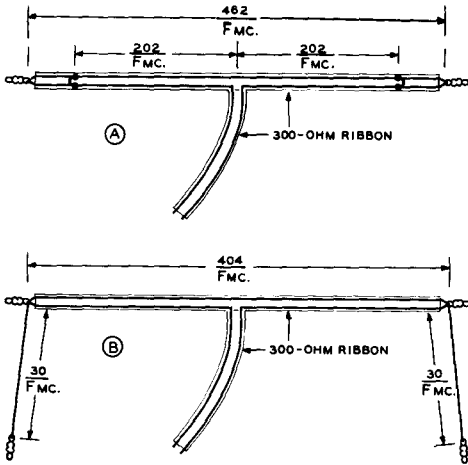

Figure 3
FOLDED DIPOLE WITH SHORTING STRAPS

The impedance match and bandwidth characteristics of a folded dipole may be improved by shorting the two wires of the ribbon a distance out from the center equal to the velocity factor of the ribbon times the half-length of the dipole as shown at (A). An alternative arrangement with bent down ends for space conservation is illustrated at (B).

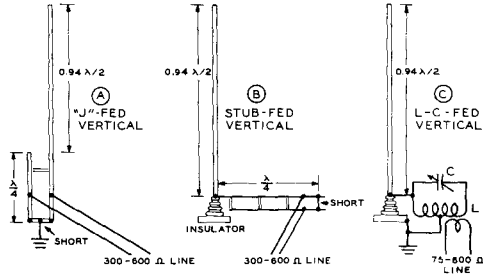

Figure 4
HALF-WAVE VERTICAL ANTENNA SHOWING ALTERNATIVE METHODS OF FEED

will give a somewhat better impedance match at normal antenna heights. Due to the asymmetry of the coaxial feed system difficulty may be encountered with waves traveling on the outside of the coaxial cable. For this reason the use of Twin-Lead is normally to be preferred over the use of coaxial cable for feeding the center of a half-wave dipole.

Off-Center Fed Doublet The system shown in figure 2 (O) is sometimes used to

feed a half-wave dipole, especially when it is desired to use the same antenna on a number of harmonically-related frequencies. The feeder wire (no. 14 enamelled wire should be used) is tapped a distance of 14 per cent of the total length of the antenna either side of center. The feeder wire, operating against ground for the return current, has an impedance of approximately 600 ohms. The system works well over highly conducting ground, but will introduce rather high losses when the antenna is located above rocky or poorly conducting soil. The off-center fed antenna has a further disadvantage that it is highly responsive to harmonics fed to it from the transmitter.

The effectiveness of the antenna system in radiating harmonics is of course an advantage when operation of the antenna on a number of frequency bands is desired. But it is necessary to use a harmonic filter to insure that only the desired frequency is fed from the transmitter to the antenna.

times over the radiation resistance of the element, have both contributed to the frequent use of the multi-wire radiator as the driven element in a parasitic antenna array.

Delta-Matched Doublet and Standard Doublet These two types of radiating elements are shown in figure 2L and figure 2M. The delta-matched doublet is described in detail in Section 22-8 of this chapter. The standard doublet, shown in figure 2M, is fed in the center by means of 75-ohm Twin-Lead, either the transmitting or the receiving type, or it may be fed by means of twisted-pair feeder or by means of parallel-wire lamp-cord. Any of these types of feed line will give an approximate match to the center impedance of the dipole, but the 75-ohm Twin-Lead is far to be preferred over the other types of low-impedance feeder due to the much lower losses of the polyethylene-dielectric transmission line.

The coaxial-cable-fed doublet shown in figure 2N is a variation on the system shown in figure 2M. Either 52-ohm coaxial cable or 75-ohm coaxial cable may be used to feed the center of the dipole, although the 75-ohm type

22-3 The Half-Wave Vertical Antenna

The half-wave vertical antenna with its bottom end from 0.1 to 0.2 wavelength above

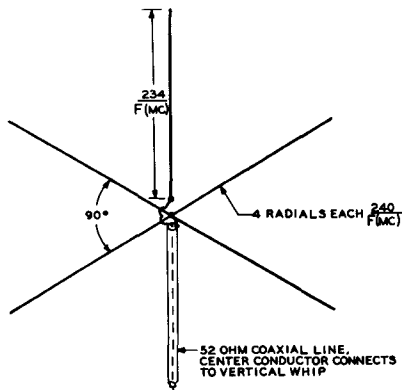

Figure 5

THE LOW-FREQUENCY GROUND PLANE ANTENNA

The radials of the ground plane antenna should lie in a horizontal plane, although slight departures from this caused by nearby objects is allowable. The whip may be mounted on a short post, or on the roof of a building. The wire radials may slope downwards towards their tips, acting as guy wires for the installation.

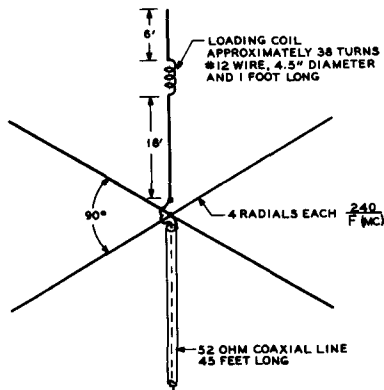

Figure 6

80 METER LOADED GROUND PLANE ANTENNA

Number of turns in loading coil to be adjusted until antenna system resonates at desired frequency in 80 meter band.

ground is an effective transmitting antenna for low-angle radiation, where ground conditions in the vicinity of the antenna are good. Such an antenna is not good for short-range sky-wave communication, such as is the normal usage of the 3.5-Mc. amateur band, but is excellent for short-range ground-wave communication such as on the standard broadcast band and on the amateur 1.8-Mc. band. The vertical antenna normally will cause greater BCI than an equivalent horizontal antenna, due to the much greater ground-wave field intensity. Also, the vertical antenna is poor for receiving under conditions where man-made interference is severe, since such interference is predominantly vertically polarized.

Three ways of feeding a half-wave vertical antenna from an untuned transmission line are illustrated in figure 4. The J-fed system shown in figure 4A is obviously not practicable except on the higher frequencies where the extra length for the stub may easily be obtained. However, in the normal case the ground-plane vertical antenna is to be recommended over the J-fed system for high frequency work.

22-4 The Ground Plane Antenna

An effective low angle radiator for any ama-

teur band is the *ground-plane antenna*, shown in figure 5. So called because of the radial ground wires, the ground-plane antenna is not affected by soil conditions in its vicinity due to the creation of an artificial ground system by the radial wires. The base impedance of the ground plane is of the order of 30 to 35 ohms, and it may be fed with 52-ohm coaxial line with only a slight impedance mis-match. For a more exact match, the ground-plane antenna may be fed with a 72-ohm coaxial line and a quarter-wave matching section made of 52-ohm coaxial line.

The angle of radiation of the ground-plane antenna is quite low, and the antenna will be found less effective for contacts under 1000 miles or so on the 80 and 40 meter bands than a high angle radiator, such as a dipole. However, for DX contacts of 1000 miles or more, the ground-plane antenna will prove to be highly effective.

The 80-Meter Loaded Ground-Plane A vertical antenna of 66 feet in height presents quite a problem on a small lot, as the supporting guy wires will tend to take up quite a large portion of the lot. Under such conditions, it is possible to shorten the length of the vertical radiator of the ground-plane by the inclusion of a loading coil in the vertical whip section. The ground-plane antenna may be artificially loaded in this manner so that a 25-foot vertical whip may be

used for the radiator. Such an antenna is shown in figure 6. The loaded ground-plane tends to have a rather high operating Q and operates only over a narrow band of frequencies. An operating range of about 100 kilocycles with a low SWR is possible on 80 meters. Operation over a larger frequency range is possible if a higher standing wave ratio is tolerated on the transmission line. The radiation resistance of a loaded 80-meter ground-plane is about 15 ohms. A quarter wavelength (45 feet) of 52-ohm coaxial line will act as an efficient feed line, presenting a load of approximately 180 ohms to the transmitter.

22-5 The Marconi Antenna

A grounded quarter-wave Marconi antenna, widely used on frequencies below 3 Mc., is sometimes used on the 3.5-Mc. band, and is also used in v-h-f mobile services where a compact antenna is required. The Marconi type antenna allows the use of half the length of wire that would be required for a half-wave Hertz radiator. The ground acts as a mirror, in effect, and takes the place of the additional quarter-wave of wire that would be required to reach resonance if the end of the wire were not returned to ground.

The fundamental practical form of the Marconi antenna system is shown in figure 7. Other Marconi antennas differ from this type primarily in regard to the method of feeding the energy to the radiator. The feed method shown in figure 7B can often be used to advantage, particularly in mobile work.

Variations on the basic Marconi antenna are shown in the illustrations of figure 8. Figures 8B and 8C show the "L"-type and "T"-type Marconi antennas. These arrangements have been more or less superseded by the top-loaded forms of the Marconi antenna shown in figures 8D, 8E, and 8F. In each of these latter three figures an antenna somewhat less than one quarter wave in length has been *loaded* to increase its effective length by the insertion of a *loading coil* at or near the top of the radiator. The arrangement shown at figure 8D gives the least loading but is the most practical mechanically. The system shown at figure 8E gives an intermediate amount of loading, while that shown at figure 8F, utilizing a "hat" just above the loading coil, gives the greatest amount of loading. The object of all the top-loading methods shown is to produce an increase in the effective length of the radiator, and thus to raise the point of maximum current in the radiator as far as pos-

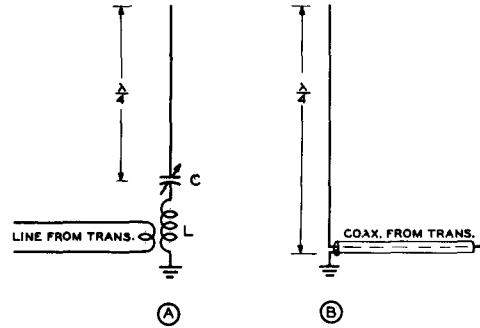

Figure 7
FEEDING A QUARTER-WAVE MARCONI ANTENNA

When an open-wire line is to be used, it may be link coupled to a series-resonant circuit between the bottom end of the Marconi and ground, as at (A). Alternatively, a reasonably good impedance match may be obtained between 52-ohm coaxial line and the bottom of a resonant quarter-wave antenna, as illustrated at (B) above.

sible above ground. Raising the maximum-current point in the radiator above ground has two desirable results: The percentage of low-angle radiation is increased and the amount of ground current at the base of the radiator is reduced, thus reducing the ground losses.

To estimate whether a loading coil will probably be required, it is necessary only to note if the length of the antenna wire and ground lead is over a quarter wavelength; if so, no loading coil is needed, provided the series tuning capacitor has a high maximum capacitance.

Amateurs primarily interested in the higher frequency bands, but who like to work 80 meters occasionally, can usually manage to resonate one of their antennas as a Marconi by working the whole system, feeders and all, against a water pipe ground, and resorting to a loading coil if necessary. A high-frequency-rotary, zepp, doublet, or single-wire-fed antenna will make quite a good 80-meter Marconi if high and in the clear, with a rather long feed line to act as a radiator on 80 meters. Where two-wire feeders are used, the feeders should be tied together for Marconi operation.

Importance of Ground Connection With a quarter-wave antenna and a ground, the antenna current generally is measured with a meter placed in the antenna circuit close to the ground connection. If this

Figure 8
LOADING THE
MARCONI ANTENNA
The various loading systems
are discussed in the accom-
panying text.

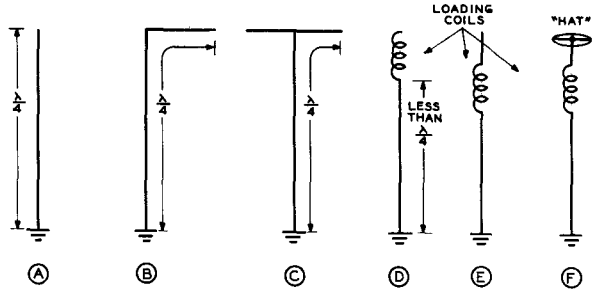

current flows through a resistor, or if the ground itself presents some resistance, there will be a power loss in the form of heat. Improving the ground connection, therefore, provides a definite means of reducing this power loss, and thus increasing the radiated power.

The best possible ground consists of as many wires as possible, each at least a quarter wave long, buried just below the surface of the earth, and extending out from a common point in the form of radials. Copper wire of any size larger than no. 16 is satisfactory, though the larger sizes will take longer to disintegrate. In fact, the radials need not even be buried; they may be supported just above the earth, and insulated from it. This arrangement is called a *counterpoise*, and operates by virtue of its high capacitance to ground.

If the antenna is physically shorter than a quarter wavelength, the antenna current is higher, due to lower radiation resistance. Consequently, the power lost in resistive soil is greater. The importance of a good ground with short, inductive-loaded Marconi radiators is, therefore, quite obvious. With a good ground system, even very short (one-eighth wavelength) antennas can be expected to give a high percentage of the efficiency of a quarter-wave antenna used with the same ground system. This is especially true when the short radiator is *top loaded* with a high Q (low loss) coil.

Water-Pipe Grounds Water pipe, because of its comparatively large surface and cross section, has a relatively low r-f resistance. If it is possible to attach to a junction of several water pipes (where they branch in several directions and run for some distance under ground), a satisfactory ground connection will be obtained. If one of the pipes attaches to a lawn or garden sprinkler system in the immediate vicinity of the antenna, the effectiveness of the system will approach that of buried copper radials.

The main objection to water-pipe grounds

is the possibility of high resistance joints in the pipe, due to the "dope" put on the coupling threads. By attaching the ground wire to a junction with three or more legs, the possibility of requiring the main portion of the r-f current to flow through a high resistance connection is greatly reduced.

The presence of water in the pipe adds nothing to the conductivity; therefore it does not relieve the problem of high resistance joints. Bonding the joints is the best insurance, but this is, of course, impracticable where the pipe is buried. Bonding together with copper wire the various water faucets above the surface of the ground will improve the effectiveness of a water-pipe ground system hampered by high-resistance pipe couplings.

Marconi Dimensions A Marconi antenna is an odd number of electrical quarter waves long (usually only one quarter wave in length), and is always resonated to the operating frequency. The correct loading of the final amplifier is accomplished by varying the coupling, *rather than by detuning the antenna from resonance.*

Physically, a quarter-wave Marconi may be made anywhere from one-eighth to three-eighths wavelength overall, meaning the total length of the antenna wire and ground lead from the end of the antenna to the point where the ground lead attaches to the junction of the radials or counterpoise wires, or where the water pipe enters the ground. The longer the antenna is made physically, the lower will be the current flowing in the ground connection, and the greater will be the overall radiation efficiency. However, when the antenna length exceeds three-eighths wavelength, the antenna becomes difficult to resonate by means of a series capacitor, and it begins to take shape as an end-fed Hertz, requiring a method of feed such as a pi network.

A radiator physically much shorter than a

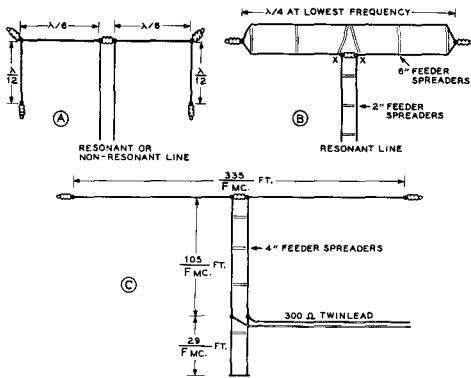

Figure 9

THREE EFFECTIVE SPACE CONSERVING ANTENNAS

The arrangements shown at (A) and (B) are satisfactory where resonant feed line can be used. However, non-resonant 75-ohm feed line may be used in the arrangement at (A) when the dimensions in wavelengths are as shown. In the arrangement shown at (B) low standing waves will be obtained on the feed line when the overall length of the antenna is a half wave. The arrangement shown at (C) may be tuned for any reasonable length of flat top to give a minimum of standing waves on the transmission line.

quarter wavelength can be lengthened electrically by means of a series loading coil, and used as a quarter-wave Marconi. However, if the wire is made shorter than approximately one-eighth wavelength, the radiation resistance will be quite low. This is a special problem in mobile work below about 20-Mc.

22-6 Space-Conserving Antennas

In many cases it is desired to undertake a considerable amount of operation on the 80-meter or 40-meter band, but sufficient space is simply not available for the installation of a half-wave radiator for the desired frequency of operation. This is a common experience of apartment dwellers. The shortened Marconi antenna operated against a good ground can be used under certain conditions, but the shortened Marconi is notorious for the production of broadcast interference, and a good ground connection is usually completely unobtainable in an apartment house.

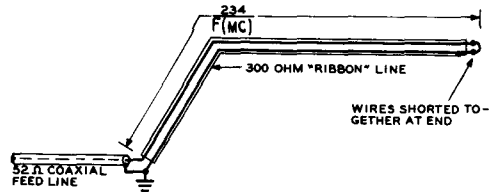
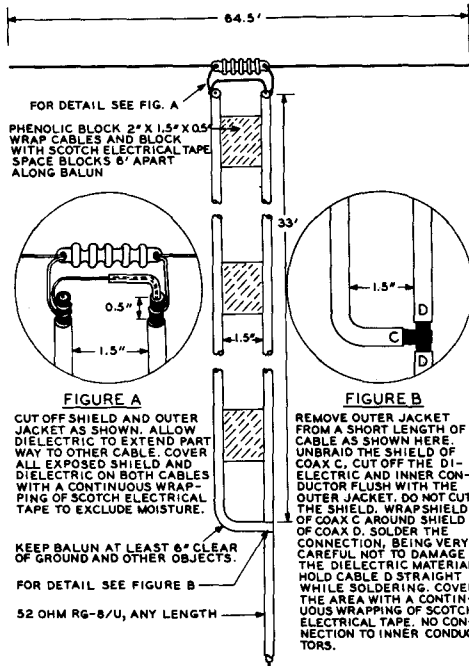

Figure 10
TWIN-LEAD MARCONI ANTENNA FOR THE
80 AND 160 METER BANDS

Essentially, the problem in producing an antenna for lower frequency operation in restricted space is to erect a short radiator which is balanced with respect to ground and which is therefore independent of ground for its operation. Several antenna types meeting this set of conditions are shown in figure 9. Figure 9A shows a conventional center-fed doublet with bent-down ends. This type of antenna can be fed with 75-ohm Twin-Lead in the center, or it may be fed with a resonant line for operation on several bands. The overall length of the radiating wire will be a few per cent greater than the normal length for such an antenna since the wire is bent at a position intermediate between a current loop and a voltage loop. The actual length will have to be determined by the cut-and-try process because of the increased effect of interfering objects on the effective electrical length of an antenna of this type.

Figure 9B shows a method for using a two-wire doublet on one half of its normal operating frequency. It is recommended that spaced open conductor be used both for the radiating portion of the folded dipole and for the feed line. The reason for this recommendation lies in the fact that the two wires of the flat top are *not* at the same potential throughout their length when the antenna is operated on one-half frequency. Twin-Lead may be used for the feed line if operation on the frequency where the flat top is one-half wave in length is most common, and operation on one-half frequency is infrequent. However, if the antenna is to be used primarily on one-half frequency as shown, it should be fed by means of an open-wire line. If it is desired to feed the antenna with a non-resonant line, a quarter-wave stub may be connected to the antenna at the points X, X in figure 9B. The stub should be tuned and the transmission line connected to it in the normal manner.

The antenna system shown in figure 9C may be used when not quite enough length is available for a full half-wave radiator. The dimen-



DIMENSIONS SHOWN HERE ARE FOR THE 40 METER BAND. THIS ANTENNA MAY BE BUILT FOR OTHER BANDS BY USING DIMENSIONS THAT ARE MULTIPLES OR SUBMULTIPLES OF THE DIMENSIONS SHOWN. BALUN SPACING IS 1.5\"/>

Figure 11

HALF-WAVE ANTENNA WITH QUARTER-WAVE UNBALANCED TO BALANCED TRANSFORMER (BALUN) FEED SYSTEM FOR 40-METER OPERATION

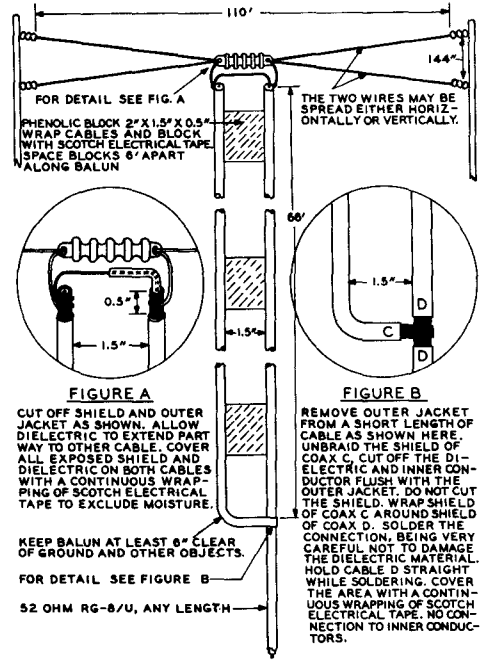

DIMENSIONS SHOWN HERE ARE FOR THE 80 METER BAND. THIS ANTENNA MAY BE BUILT FOR OTHER BANDS BY USING DIMENSIONS THAT ARE MULTIPLES OR SUBMULTIPLES OF THE DIMENSIONS SHOWN. BALUN SPACING IS 1.5\"/>

Figure 12

BROADBAND ANTENNA WITH QUARTER-WAVE UNBALANCED TO BALANCED TRANSFORMER (BALUN) FEED SYSTEM FOR 80-METER OPERATION

sions in terms of frequency are given on the drawing. An antenna of this type is 93 feet long for operation on 3600 kc. and 86 feet long for operation on 3900 kc. This type of antenna has the additional advantage that it may be operated on the 7-Mc. and 14-Mc. bands, when the flat top has been cut for the 3.5-Mc. band, simply by changing the position of the shorting bar and the feeder line on the stub.

A sacrifice which must be made when using a shortened radiating system, as for example the types shown in figure 9, is in the bandwidth of the radiating system. The frequency range which may be covered by a shortened antenna system is approximately in proportion to the amount of shortening which has been employed. For example, the antenna system shown in figure 9C may be operated over the range from 3800 kc. to 4000 kc. without serious standing waves on the feed line. If the

antenna had been made full length it would be possible to cover about half again as much frequency range for the same amount of mismatch on the extremes of the frequency range.

The Twin-Lead Marconi Antenna Much of the power loss in the Marconi antenna is a result of low radiation resistance and high ground resistance. In some cases, the ground resistance may even be higher than the radiation resistance, causing a loss of 50 per cent or more of the transmitter power output. If the radiation resistance of the Marconi antenna is raised, the amount of power lost in the ground resistance is proportionately less. If a Marconi antenna is made out of 300 ohm TV-type ribbon line, as shown in figure 10, the radiation resistance of the antenna is raised from a low value of 10 or 15 ohms to a more reasonable value of 40 to 60

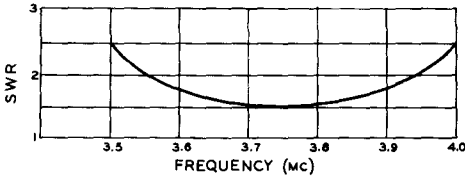

Figure 13

SWR CURVE OF 80-METER BROAD-BAND DIPOLE

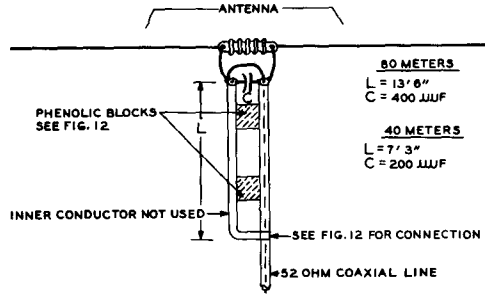

Figure 14

SHORT BALUN FOR 40 AND 80 METERS

ohms. The ground losses are now reduced by a factor of 4. In addition, the antenna may be directly fed from a 50-ohm coaxial line, or directly from the unbalanced output of a pi-network transmitter.

Since a certain amount of power may still be lost in the ground connection, it is still of greatest importance that a good, low resistance ground be used with this antenna.

The Collins Broad-band Dipole System Shown in figures 11 and 12 are broad-band dipoles for the 40 and 80 meter amateur bands, designed by Collins Radio Co. for use with the Collins 32V-3 and KW-1 transmitters. These fan-type dipoles have excellent broad-band response, and are designed to be fed with a 52-ohm unbalanced coaxial line, making them suitable for use with many of the other modern transmitters, such as the Barker and Williamson 5100, Johnson Ranger, and Viking. The antenna system consists of a fan-type dipole, a balun matching section, and a suitable coaxial feedline. The Q of the half-wave 80 meter doublet is lowered by decreasing the effective length-to-diameter ratio. The frequency range of operation of the doublet is increased considerably by this change. A typical SWR curve for the 80 meter doublet is shown in figure 13.

The balanced doublet is matched to the unbalanced coaxial line by the one-quarter wave balun. If desired, a shortened balun may be used (figure 14). The short balun is capacity loaded at the junction between the balun and the broad-band dipole.

22-7 Multi-Band Antennas

The availability of a multi-band antenna is a great operating convenience to an amateur station. In most cases it will be found best to install an antenna which is optimum for the band which is used for the majority of the

available operating time, and then to have an additional multi-band antenna which may be pressed into service for operation on another band when propagation conditions on the most frequently used band are not suitable. Most amateurs use, or plan to install, at least one directive array for one of the higher-frequency bands, but find that an additional antenna which may be used on the 3.5-Mc. and 7.0-Mc. band, or even up through the 28-Mc. band is almost indispensable.

The choice of a multi-band antenna depends upon a number of factors such as the amount of space available, the band which is to be used for the majority of operating with the antenna, the radiation efficiency which is desired, and the type of antenna tuning network to be used at the transmitter. A number of recommended types are shown in the next pages.

The ¼-Wave Folded Doublet

Figure 15 shows an antenna type which will be found to be very effective when a moderate amount of space is available, when most of the operating will be done on one band with occasional operation on the second harmonic. The system is quite satisfactory for use with high-power transmitters since a 600-ohm non-resonant line is used from the antenna to the transmitter and since the antenna system is balanced with respect to ground. With operation on the fundamental frequency of the antenna where the flat top is ¼ wave long the switch SW is left open. The system affords a very close match between the 600-ohm line and the feed point of the antenna. Kraus has reported a standing-wave ratio of approximately 1.2 to 1 over the 14-Mc. band when the antenna was located approximately one-half wave above ground.

For operation on the second harmonic the switch SW is closed. The antenna is still an

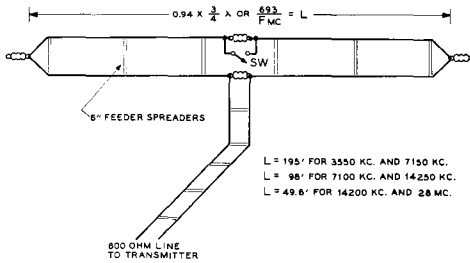

Figure 15
THE THREE-QUARTER WAVE FOLDED DOUBLET

This antenna arrangement will give very satisfactory operation with a 600-ohm feed line for operation with the switch open on the fundamental frequency and with the switch closed on twice frequency.

effective radiator on the second harmonic but the pattern of radiation will be different from that on the fundamental, and the standing-wave ratio on the feed line will be greater. The flat top of the antenna must be made of open wire rather than ribbon or tubular line.

For greater operating convenience, the shorting switch may be replaced with a section of transmission line. If this transmission line is made one-quarter wavelength long for the fundamental frequency, and the free end of the line is shorted, it will act as an open circuit across the center insulator. At the second harmonic, the transmission line is one-half wavelength long, and reflects the low impedance of the shorted end across the center insulator. Thus the switching action is automatic as the frequency of operation is changed. Such an installation is shown in figure 16.

The End-Fed Hertz The end-fed Hertz antenna shown in figure 17 is not as effective a radiating system as

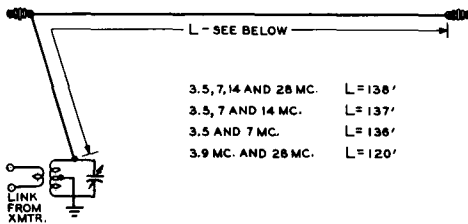

3.5, 7, 14 AND 28 MC.	L = 138'
3.5, 7 AND 14 MC.	L = 137'
3.5 AND 7 MC.	L = 136'
3.9 MC. AND 28 MC.	L = 120'

Figure 17
RECOMMENDED LENGTHS FOR THE END-FED HERTZ

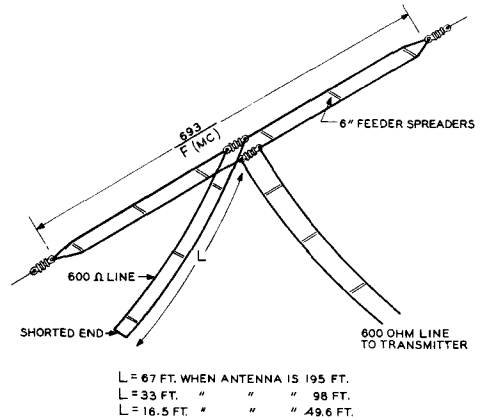

L = 67 FT. WHEN ANTENNA IS 195 FT.
L = 33 FT. " " " 98 FT.
L = 16.5 FT. " " " 49.6 FT.

Figure 16
AUTOMATIC BANDSWITCHING STUB FOR THE THREE-QUARTER WAVE FOLDED DOUBLET

The antenna of Figure 15 may be used with a shorted stub line in place of the switch normally used for second harmonic operation.

many other antenna types, but it is particularly convenient when it is desired to install an antenna in a hurry for a test, or for field-day work. The flat top of the radiator should be as high and in the clear as possible. In any event at least three quarters of the total wire length should be in the clear. Dimensions for optimum operation on various amateur bands are given in addition in figure 17.

The End-Fed Zepp The end-fed Zepp has long been a favorite for multi-band operation. It is shown in figure 18 along with recommended dimensions for operation on various amateur band groups.

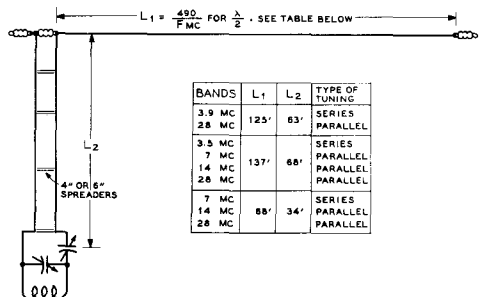

BANDS	L1	L2	TYPE OF TUNING
3.9 MC	125'	83'	SERIES
28 MC			PARALLEL
3.5 MC	137'	88'	SERIES
7 MC			PARALLEL
14 MC AND 28 MC			PARALLEL
7 MC	88'	34'	SERIES
14 MC			PARALLEL
28 MC			PARALLEL

END-FED ZEPP

FIGURE 18

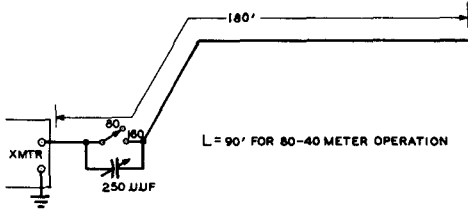

Figure 19

A TWO-BAND MARCONI ANTENNA FOR 160-80 METER OPERATION

Since this antenna type is an unbalanced radiating system, its use is not recommended with high-power transmitters where interference to broadcast listeners is likely to be encountered. The r-f voltages encountered at the end of zepp feeders and at points an electrical half wave from the end are likely to be quite high. Hence the feeders should be supported an adequate distance from surrounding objects and sufficiently in the clear so that a chance encounter between a passerby and the feeder is unlikely.

The coupling coil at the transmitter end of the feeder system should be link coupled to the output of the low-pass TVI filter in order to reduce harmonic radiation.

The Two-Band Marconi Antenna A three-eighths wavelength Marconi antenna may be operated on its harmonic frequency, providing good two band performance from a simple wire. Such an arrangement for operation on 160-80 meters, and 80-40 meters is shown in figure 19. On the fundamental (lowest) frequency, the antenna acts as a three-eighths wavelength series-tuned Marconi. On the second harmonic, the antenna is a current-fed three-quarter wavelength antenna operating against ground. For proper operation, the antenna should be resonated on its second harmonic by means of a grid-dip oscillator to the operating frequency most used on this particular band. The Q of the antenna is relatively low, and the antenna will perform well over a frequency range of several hundred kilocycles.

The overall length of the antenna may be varied slightly to place its self-resonant frequency in the desired region. Bends or turns in the antenna tend to make it resonate higher in frequency, and it may be necessary to lengthen it a bit to resonate it at the chosen frequency. For fundamental operation, the series condenser is inserted in the circuit, and the antenna may be resonated to any point in the lower frequency band. As with any Marconi

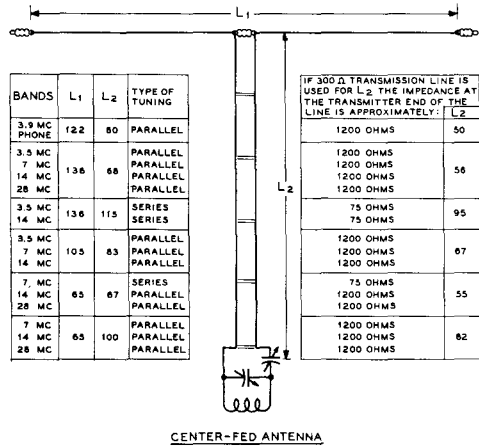

Figure 20

DIMENSIONS FOR CENTER-FED MULTI-BAND ANTENNA

type antenna, the use of a good ground is essential. This antenna works well with transmitters employing coaxial antenna feed, since its transmitting impedance on both bands is in the neighborhood of 40 to 60 ohms. It may be attached directly to the output terminal of such transmitters as the Collins 32V and the Viking II. The use of a low-pass TVI filter is of course recommended.

The Center-Fed Multi-Band Antenna For multi-band operation, the center fed antenna is without doubt the best compromise. It is a balanced system on all bands, it requires no ground return, and when properly tuned has good rejection properties for the higher harmonics generated in the transmitter. It is well suited for use with the various multi-band 150-watt transmitters that are currently so popular. For proper operation with these transmitters, an antenna tuning unit *must* be used with the center-fed antenna. In fact, some sort of tuning unit is necessary for any type of efficient, multi-band antenna. The use of such questionable antennas as the "off-center fed" doublet is an invitation to TVI troubles and improper operation of the transmitter. A properly balanced antenna is the best solution to multi-band operation. When used in conjunction with an antenna tuning unit, it will perform with top efficiency on all of the major amateur bands.

Several types of center-fed antenna systems are shown in figure 20. If the feed line is made up in the conventional manner of no. 12 or no.

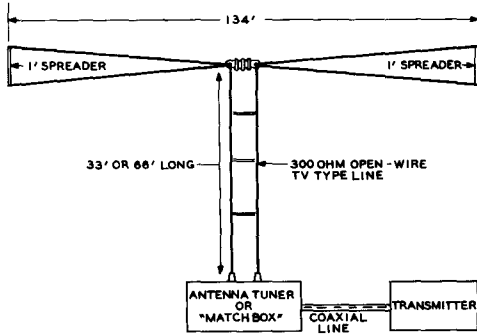

Figure 21
MULTI-BAND ANTENNA USING FAN-DIPOLE TO LIMIT IMPEDANCE EXCURSIONS ON HARMONIC FREQUENCIES

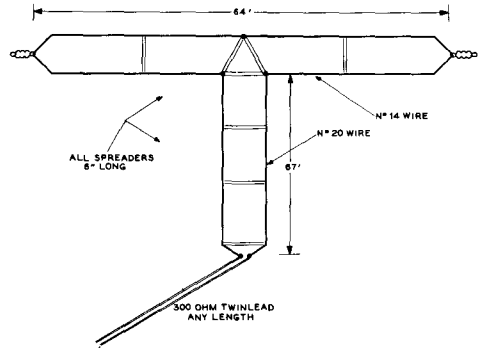

Figure 22
FOLDED-TOP DUAL-BAND ANTENNA

14 wire spaced 4 to 6 inches the antenna system is sometimes called a center-fed zepp. With this type of feeder the impedance at the transmitter end of the feeder varies from about 70 ohms to approximately 5000 ohms, the same as is encountered in an end-fed zepp antenna. This great impedance ratio requires provision for either series or parallel tuning of the feeders at the transmitter, and involves quite high r-f voltages at various points along the feed line.

If the feed line between the transmitter and the antenna is made to have a characteristic impedance of approximately 300 ohms the excursions in end-of-feeder impedance are greatly reduced. In fact the impedance then varies from approximately 75 ohms to 1200 ohms. With this much lowered impedance variation it is usually possible to use series tuning on all bands, or merely to couple the antenna directly to the output tank circuit or the harmonic reduction circuit without any separate feeder tuning provision.

There are several practicable types of transmission line which can give an impedance of approximately 300 ohms. The first is, obviously, 300-ohm Twin-Lead. Twin-Lead of the receiving type may be used as a resonant feed line in this case, but its use is not recommended with power levels greater than perhaps 150 watts, and it should not be used when lowest loss in the transmission line is desired.

For power levels up to 250 watts or so, the transmitting type tubular 300-ohm line may be used, or the open-wire 300-ohm line may be employed. For power levels higher than this, a 4-wire transmission line, or a line built of one-quarter inch tubing should be used.

Even when a 300-ohm transmission line is used, the end-of-feeder impedance may reach a high value, particularly on the second harmonic of the antenna. To limit the impedance excursions, a two-wire flat-top may be employed for the radiator, as shown in figure 21. The use of such a radiator will limit the impedance excursions on the harmonic frequencies of the antenna and make the operation of the antenna matching unit much less critical. The use of a two-wire radiator is highly recommended for any center-fed multi-band antenna.

Folded Flat-Top Dual-Band Antenna As has been mentioned earlier, there is an increasing tendency among amateur operators to utilize rotary or fixed arrays for the 14-Mc. band and those higher in frequency. In order to afford complete coverage of the amateur bands it is then desirable to have an additional system which will operate with equal effectiveness on the 3.5-Mc. and 7-Mc. bands, but this low-frequency antenna system will not be required to operate on any bands higher in frequency than the 7-Mc. band. The antenna system shown in figure 22 has been developed to fill this need.

This system consists essentially of an open-line folded dipole for the 7-Mc. band with a special feed system which allows the antenna to be fed with minimum standing waves on the feed line on both the 7-Mc. and 3.5-Mc. bands. The feed-point impedance of a folded dipole on its fundamental frequency is approximately 300 ohms. Hence the 300-ohm Twin-Lead shown in figure 22 can be connected directly into the center of the system for operation only on the 7-Mc. band and standing waves on the feeder will be very small. However, it is possible to insert an electrical half-wave

of transmission line of any characteristic impedance into a feeder system such as this and the impedance at the far end of the line will be exactly the same value of impedance which the half-wave line sees at its termination. Hence this has been done in the antenna system shown in figure 22; an electrical half wave of line has been inserted between the feed point of the antenna and the 300-ohm transmission line to the transmitter.

The characteristic impedance of this additional half-wave section of transmission line has been made about 715 ohms (no. 20 wire spaced 6 inches), but since it is an electrical half wave long at 7 Mc. and operates into a load of 300 ohms at the antenna the 300-ohm Twin-Lead at the bottom of the half-wave section still sees an impedance of 300 ohms. The additional half-wave section of transmission line introduces a negligible amount of loss since the current flowing in the section of line is the same which would flow in a 300-ohm line at each end of the half-wave section, and at all other points it is less than the current which would flow in a 300-ohm line since the effective impedance is greater than 300 ohms in the center of the half-wave section. This means that the loss is less than it would be in an equivalent length of 300-ohm Twin-Lead since this type of manufactured transmission line is made up of conductors which are equivalent to no. 20 wire.

So we see that the added section of 715-ohm line has substantially no effect on the operation of the antenna system on the 7-Mc. band. However, when the flat top of the antenna is operated on the 3.5-Mc. band the feed-point impedance of the flat top is approximately 3500 ohms. Since the section of 715-ohm transmission line is an electrical *quarter-wave* in length on the 3.5-Mc. band, this section of line will have the effect of transforming the approximately 3500 ohms feed-point impedance of the antenna down to an impedance of about 150 ohms which will result in a 2:1 standing-wave ratio on the 300-ohm Twin-Lead transmission line from the transmitter to the antenna system.

The antenna system of figure 22 operates with very low standing waves over the entire 7-Mc. band, and it will operate with moderate standing waves from 3500 to 3800 kc. in the 3.5-Mc. band and with sufficiently low standing-wave ratio so that it is quite usable over the entire 3.5-Mc. band.

This antenna system, as well as all other types of multi-band antenna systems, must be used in conjunction with some type of harmonic-reducing antenna tuning network even though the system does present a convenient impedance value on both bands.

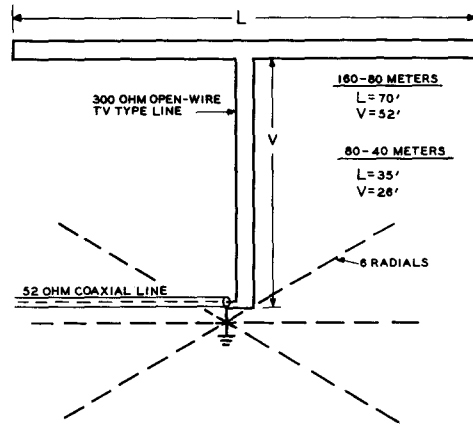

Figure 23

THE MULTEE TWO-BAND ANTENNA

This compact antenna can be used with excellent results on 160/80 and 80/40 meters. The feedline should be held as vertical as possible, since it radiates when the antenna is operated on its fundamental frequency.

The "Multee" Antenna An antenna that works well on 160 and 80 meters, or 80 and 40 meters and is sufficiently compact to permit erection on the average city lot is the *W6BCX Multee* antenna, illustrated in figure 23. The antenna evolves from a vertical two wire radiator, fed on one leg only. On the low frequency band the top portion does little radiating, so it is folded down to form a radiator for the higher frequency band. On the lower frequency band, the antenna acts as a top loaded vertical radiator, while on the higher frequency band, the flat-top does the radiating rather than the vertical portion. The vertical portion acts as a quarter-wave linear transformer, matching the 6000 ohm antenna impedance to the 50 ohm impedance of the coaxial transmission line.

The earth below a vertical radiator must be of good conductivity not only to provide a low resistance ground connection, but also to provide a good reflecting surface for the waves radiated downward towards the ground. For best results, a radial system should be installed beneath the antenna. For 160-80 meter operation, six radials 50 feet in length, made of no. 16 copper wire should be buried just below the surface of the ground. While an ordinary water pipe ground system with no radials may be used, a system of radials will provide a worthwhile increase in signal strength. For 80-40 meter operation, the length

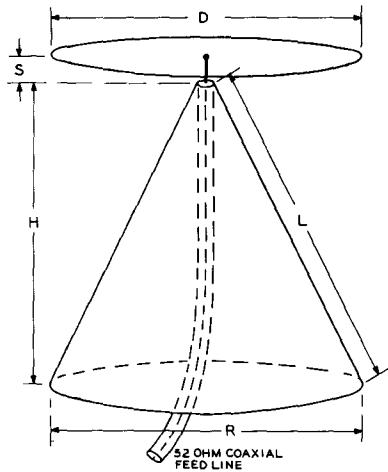

20, 15, 11, 10, 6 METERS		15, 11, 10, 6 METERS		11, 10, 6, 2 METERS	
D=12'	L=18'	D=8'	L=12'	D=6'	L=9'6"
S=10"	R=18'	S=6"	R=12'	S=4"	R=9'6"
H=15'7"		H=10'5"		H=8'3"	

Figure 24

DIMENSIONS OF LOW-FREQUENCY DISCONE ANTENNA FOR LOW FREQUENCY CUTOFF AT 13.2 MC., 20.1 MC., AND 26 MC.

The Discone is a vertically polarized radiator, producing an omnidirectional pattern similar to a ground plane. Operation on several amateur bands with low SWR on the coaxial feed line is possible. Additional information on L-F Discone by W2RYI in July, 1950 CQ magazine.

of the radials may be reduced to 25 feet. As with all multi-band antennas that employ no lumped tuned circuits, this antenna offers no attenuation to harmonics of the transmitter. When operating on the lower frequency band, it would be wise to check the transmitter for second harmonic emission, since this antenna will effectively radiate this harmonic.

The Low-Frequency Discone The discone antenna is widely used on the v-h-f bands, but until recently

it has not been put to any great use on the lower frequency bands. Since the discone is a broad-band device, it may be used on several harmonically related amateur bands. Size is the limiting factor in the use of a discone, and the 20 meter band is about the lowest practical frequency for a discone of reasonable dimensions. A discone designed for 20 meter operation may be used on 20, 15, 11, 10 and

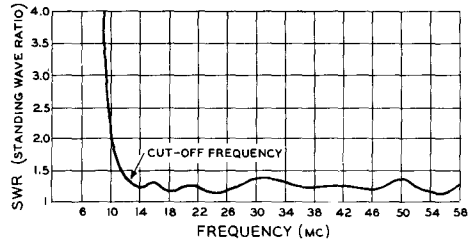

Figure 25

SWR CURVE FOR A 13.2 MC. DISCONE ANTENNA. SWR IS BELOW 1.5 TO 1 FROM 13.0 MC. TO 58 MC.

6 meters with excellent results. It affords a good match to a 50 ohm coaxial feed system on all of these bands. A practical discone antenna is shown in figure 24, with a SWR curve for its operation over the frequency range of 13-55 Mc. shown in figure 25. The discone antenna radiates a vertically polarized wave and has a very low angle of radiation. For v-h-f work the discone is constructed of sheet metal, but for low frequency work it may be made of copper wire and aluminum angle stock. A suitable mechanical layout for a low frequency discone is shown in figure 26. Smaller versions of this antenna may be constructed for 15, 11, 10 and 6 meters, or for 11, 10, 6 and 2 meters as shown in the chart of figure 24.

For minimum wind resistance, the top "hat" of the discone is constructed from three-quarter inch aluminum angle stock, the rods being bolted to an aluminum plate at the center of the structure. The tips of the rods are all connected together by lengths of no. 12 enamelled copper wire. The cone elements are made of no. 12 copper wire and act as guy wires for the discone structure. A very rigid arrangement may be made from this design; one that will give no trouble in high winds. A 4" x 4" post can be used to support the discone structure.

The discone antenna may be fed by a length of 50-ohm coaxial cable directly from the transmitter, with a very low SWR on all bands.

The Single-Wire-Fed Antenna The old favorite single-wire fed antenna system is quite satisfactory for an impromptu all band antenna system. It is widely used for portable installations and "Field Day" contests where a simple, multi-band antenna is required. A single wire feeder has a characteristic impedance of some 500 ohms, de-

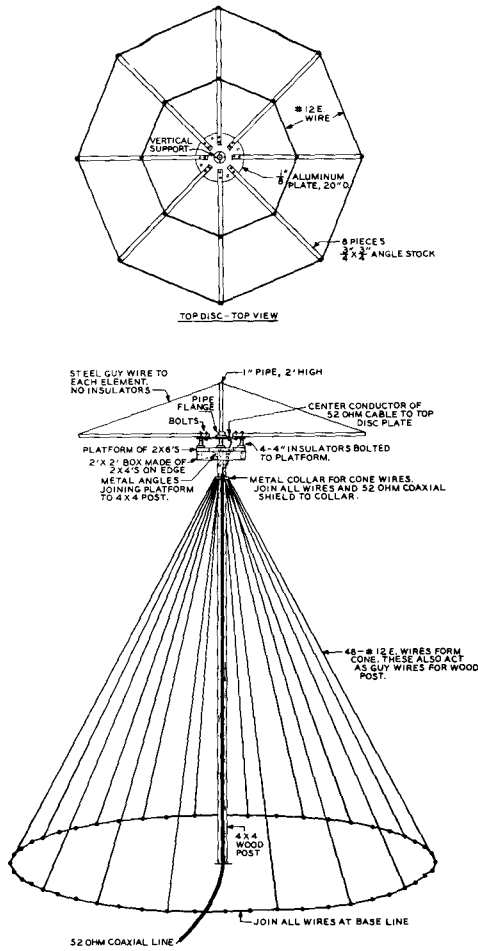

Figure 26
MECHANICAL CONSTRUCTION OF 20-METER DISCONE

pending upon the wire size and the point of attachment to the antenna. The earth losses are comparatively low over ground of good conductivity. Since the single wire feeder radiates, it is necessary to bring it away from the antenna at right angles to the antenna wire for at least one-half the length of the antenna.

The correct point for best impedance match on the fundamental frequency is not suitable for harmonic operation of the antenna. In addition, the correct length of the antenna for fundamental operation is not correct for harmonic operation. Consequently, a compromise

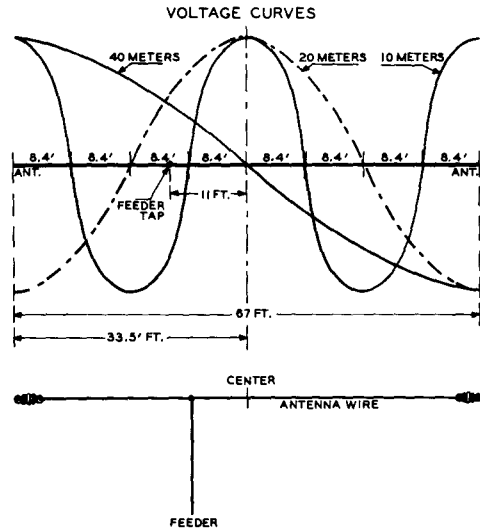

Figure 27
SINGLE-WIRE-FED ANTENNA FOR ALL-BAND OPERATION

An antenna of this type for 40-, 20- and 10-meter operation would have a radiator 67 feet long, with the feeder tapped 11 feet off center. The feeder can be 33, 66 or 99 feet long. The same type of antenna for 80-, 40-, 20- and 10-meter operation would have a radiator 134 feet long, with the feeder tapped 22 feet off center. The feeder can be either 66 or 132 feet long. This system should be used only with those coupling methods which provide good harmonic suppression.

must be made in antenna length and point of feeder connection to enable the single-wire-fed antenna to operate on more than one band. Such a compromise introduces additional reactance into the single wire feeder, and might cause loading difficulties with pi-network transmitters. To minimize this trouble, the single wire feeder should be made a multiple of 33 feet long.

Two typical single-wire-fed antenna systems are shown in figure 27 with dimensions for multi-band operation.

22-8 Matching Non-Resonant Lines to the Antenna

Present practice in regard to the use of transmission lines for feeding antenna systems on the amateur bands is about equally divided

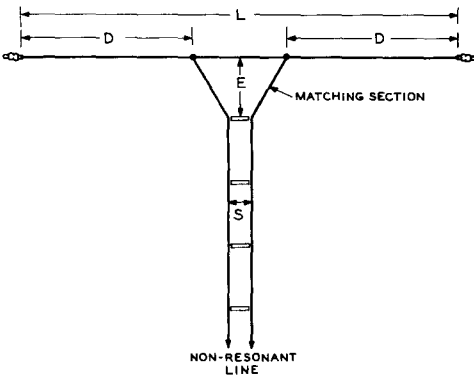

Figure 28
THE DELTA-MATCHED DIPOLE ANTENNA
The dimensions for the portions of the antenna are given in the text.

transmitter end of the feed line which will change the magnitude of the standing waves on the antenna transmission line.

Delta-Matched Antenna System The delta type matched-impedance antenna system is shown in figure 28. The impedance of the transmission line is transformed gradually into a higher value by the fanned-out Y portion of the feeders, and the Y portion is tapped on the antenna at points where the antenna impedance is a compromise between the impedance at the ends of the Y and the impedance of the unfanned portion of the line.

The constants of the system are rather critical, and the antenna must resonate at the operating frequency in order to minimize standing waves on the line. Some slight readjustment of the taps on the antenna is desirable, if appreciable standing waves persist in appearing on the line.

The constants for a doublet are determined by the following formulas:

between three types of transmission line: (1) Ribbon or tubular molded 300-ohm line is widely used up to moderate power levels (the "transmitting" type is useable up to the kilowatt level). (2) Open-wire 400 to 600 ohm line is most commonly used when the antenna is some distance from the transmitter, because of the low attenuation of this type of line. (3) Coaxial line (usually RG-8/U with a 52-ohm characteristic impedance) is widely used in v-h-f work and also on the lower frequencies where the feed line must run underground or through the walls of a building. Coaxial line also is of assistance in TVI reduction since the r-f field is entirely enclosed within the line. Molded 75-ohm line is sometimes used to feed a doublet antenna, but the doublet has been largely superseded by the folded-dipole antenna fed by 300-ohm ribbon or tubular line when an antenna for a single band is required.

$$L_{\text{feet}} = \frac{467.4}{F_{\text{megacycles}}}$$

$$D_{\text{feet}} = \frac{175}{F_{\text{megacycles}}}$$

$$E_{\text{feet}} = \frac{147.6}{F_{\text{megacycles}}}$$

Standing Waves As was discussed earlier, standing waves on the antenna transmission line, in the transmitting case, are a result of reflection from the point where the feed line joins the antenna system. The magnitude of the standing waves is determined by the degree of mismatch between the characteristic impedance of the transmission line and the input impedance of the antenna system. When the feed-point impedance of the antenna is resistive and of the same value as the characteristic impedance of the feed line, standing waves will not exist on the feeder. It may be well to repeat at this time that there is no adjustment which can be made at the

Where L is antenna length; D is the distance *in from each end* at which the Y taps on; E is the height of the Y section.

Since these constants are correct only for a 600-ohm transmission line, the spacing S of the line must be approximately 75 times the diameter of the wire used in the transmission line. For no. 14 B & S wire, the spacing will be slightly less than 5 inches. This system should never be used on either its even or odd harmonics, as entirely different constants are required when more than a single half wavelength appears on the radiating portion of the system.

Multi-Wire Doublets When a doublet antenna or the driven element in an array consists of more than one wire or tubing conductor the radiation resistance of the antenna or array is increased slightly as a result of the increase in the effective diameter of the element. Further, if we split just one

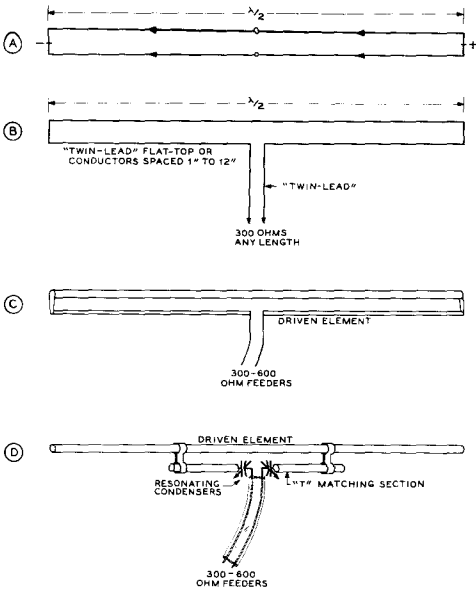

Figure 29

FOLDED-ELEMENT MATCHING SYSTEMS

Drawing (A) above shows a half-wave made up to two parallel wires. If one of the wires is broken as in (B) and the feeder connected, the feed-point impedance is multiplied by four; such an antenna is commonly called a "folded doublet." The feed-point impedance for a simple half-wave doublet fed in this manner is approximately 300 ohms, depending upon antenna height. Drawing (C) shows how the feed-point impedance can be multiplied by a factor greater than four by making the half of the element that is broken smaller in diameter than the unbroken half. An extension of the principles of (B) and (C) is the arrangement shown at (D) where the section into which the feeders are connected is considerably shorter than the driven element. This system is most convenient when the driven element is too long (such as for a 28-Mc. or 14-Mc. array) for a convenient mechanical arrangement of the system shown at (C).

wire of such a radiator, as shown in figure 29, the effective feed-point resistance of the antenna or array will be increased by a factor of N^2 where N is equal to the number of conductors, all in parallel, of the same diameter in the array. Thus if there are two conductors of the same diameter in the driven element or the antenna the feed-point resistance will be multiplied by 2^2 or 4. If the antenna has a radiation resistance of 75 ohms its feed-point resistance will be 300 ohms, this is the case

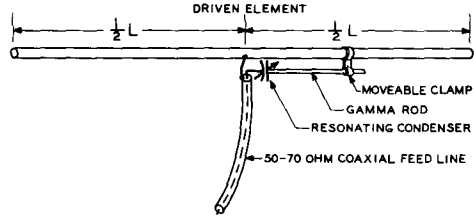

Figure 30
THE GAMMA MATCH FOR CONNECTING AN UNBALANCED COAXIAL LINE TO A BALANCED DRIVEN ELEMENT

of the conventional *folded-dipole* as shown in figure 29B.

If three wires are used in the driven radiator the feed-point resistance is increased by a factor of 9; if four wires are used the impedance is increased by a factor of 16, and so on. In certain cases when feeding a parasitic array it is desirable to have an impedance step up different from the value of 4:1 obtained with two elements of the same diameter and 9:1 with three elements of the same diameter. Intermediate values of impedance step up may be obtained by using two elements of different diameter for the complete driven element as shown in figure 29C. If the conductor that is broken for the feeder is of smaller diameter than the other conductor of the radiator, the impedance step up will be greater than 4:1. On the other hand if the larger of the two elements is broken for the feeder the impedance step up will be less than 4:1.

The "T" Match A method of matching a balanced low-impedance transmission line to the driven element of a parasitic array is the *T match* illustrated in figure 29D. This method is an adaptation of the multi-wire doublet principle which is more practicable for lower-frequency parasitic arrays such as those for use on the 14-Mc. and 28-Mc. bands. In the system a section of tubing of approximately one-half the diameter of the driven element is spaced about four inches below the driven element by means of clamps which hold the T-section mechanically and which make electrical connection to the driven element. The length of the T-section is normally between 15 and 30 inches each side of the center of the dipole for transmission lines of 300 to 600 ohms impedance, assuming 28-Mc. operation. In series with each leg of the T-section and the transmission line is a series resonating capacitor. These two capacitors tune out the reactance of the T-

section. If they are not used, the T-section will detune the dipole when the T-section is attached to it. The two capacitors may be ganged together, and once adjusted for minimum detuning action, they may be locked. A suitable housing should be devised to protect these capacitors from the weather. Additional information on the adjustment of the T-match is given in the chapter covering rotary beam antennas.

The "Gamma" Match An unbalanced version of the T-match may be used to feed a dipole from an unbalanced coaxial line. Such a device is called a *Gamma Match*, and is illustrated in figure 30.

The length of the Gamma rod and the spacing of it from the dipole determine the impedance level at the transmission line end of the rod. The series capacitor is used to tune out the reactance introduced into the system by the Gamma rod. The adjustment of the Gamma Match is discussed in the chapter covering rotary beam antennas.

Matching Stubs By connecting a resonant section of transmission line (called a *matching stub*) to either a voltage or current loop and attaching parallel-wire non-resonant feeders to the resonant stub at a suitable voltage (impedance) point, standing waves on the line may be virtually eliminated. The stub is made to serve as an auto-transformer. Stubs are particularly adapted to matching an open line to certain directional arrays, as will be described later.

Voltage Feed When the stub attaches to the antenna at a voltage loop, the stub should be a quarter wavelength long electrically, and be shorted at the bottom end. The stub can be resonated by sliding the shorting bar up and down before the non-resonant feeders are attached to the stub, the antenna being shock-excited from a separate radiator during the process. Slight errors in the length of the radiator can be compensated for by adjustment of the stub if both sides of the stub are connected to the radiator in a symmetrical manner. Where only one side of the stub connects to the radiating system, as in the Zepp and in certain antenna arrays, the radiator length must be exactly right in order to prevent excessive unbalance in the untuned line.

A dial lamp may be placed in the center of the shorting stub to act as an r-f indicator.

Current Feed When a stub is used to current-feed a radiator, the stub should either be left *open* at the bottom end instead of shorted, or else made a *half wave* long.

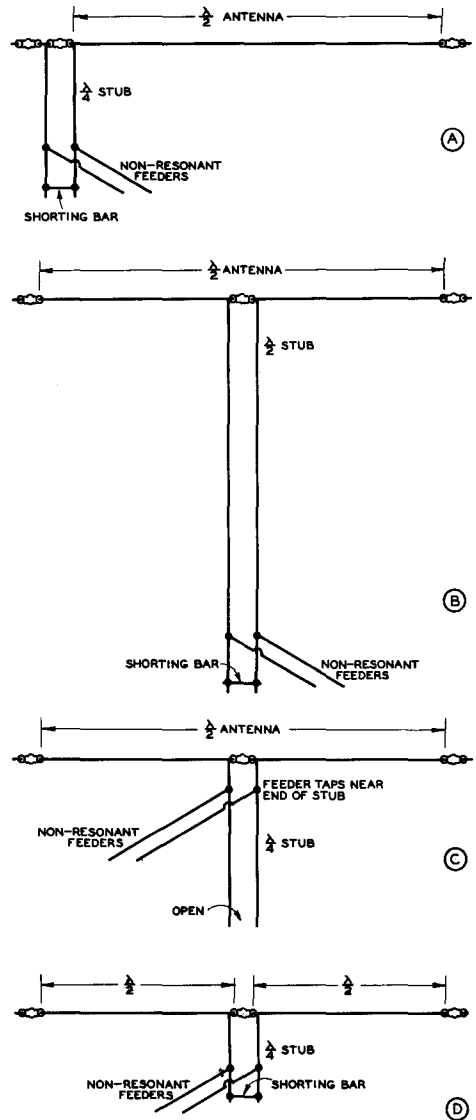

Figure 31
MATCHING-STUB APPLICATIONS

An end-fed half-wave antenna with a quarter-wave shorted stub is shown at (A). (B) shows the use of a half-wave shorted stub to feed a relatively low impedance point such as the center of the driven element of a parasitic array, or the center of a half-wave dipole. The use of an open-ended quarter-wave stub to feed a low impedance is illustrated at (C). (D) shows the conventional use of a shorted quarter-wave stub to voltage feed two half-wave antennas with a 180° phase difference.

The open stub should be resonated in the same manner as the shorted stub before attaching the transmission line; however, in this case, it is necessary to prune the stub to resonance, as there is no shorting bar.

Sometimes it is handy to have a stub hang from the radiator to a point that can be reached from the ground, in order to facilitate adjustment of the position of the transmission-line attachment. For this reason, a quarter-wave stub is sometimes made three-quarters wavelength long at the higher frequencies, in order to bring the bottom nearer the ground. Operation with any *odd* number of quarter waves is the same as for a quarter-wave stub.

Any number of *half waves* can be added to either a quarter-wave stub or a half-wave stub without disturbing the operation, though losses and frequency sensitivity will be lowest if the shortest usable stub is employed. See figure 31.

Stub Length (Electrical)	Current-Fed Radiator	Voltage-Fed Radiator
¼-¾-1¼-etc. wavelengths	Open Stub	Shorted Stub
½-1-1½-2-etc. wavelengths	Shorted Stub	Open Stub

Linear R-F Transformers A resonant quarter-wave line has the unusual property of acting much as a transformer.

Let us take, for example, a section consisting of no. 12 wire spaced 6 inches, which happens to have a surge impedance of 600 ohms. Let the far end be terminated with a pure resistance, and let the near end be fed with radio-frequency energy at the frequency for which the line is a *quarter wavelength* long. If an impedance measuring set is used to measure the impedance at the near end while the impedance at the far end is varied, an interesting relationship between the 600-ohm characteristic surge impedance of this particular quarter-wave matching line, and the impedance at the ends will be discovered.

When the impedance at the far end of the line is the same as the characteristic surge impedance of the line itself (600 ohms), the impedance measured at the near end of the quarter-wave line will also be found to be 600 ohms.

Under these conditions, the line would not have any standing waves on it, since it is terminated in its characteristic impedance. Now, let the resistance at the far end of the line be doubled, or changed to 1200 ohms. The impedance measured at the near end of the line will be found to have been cut in

half, to 300 ohms. If the resistance at the far end is made half the original value of 600 ohms or 300 ohms, the impedance at the near end doubles the original value of 600 ohms, and becomes 1200 ohms. As one resistance goes up, the other goes down proportionately.

It will always be found that the characteristic surge impedance of the quarter-wave matching line is the geometric mean between the impedance at both ends. This relationship is shown by the following formula:

$$Z_{MS} = \sqrt{Z_A Z_L}$$

where

Z_{MS} = Impedance of matching section.

Z_A = Antenna resistance.

Z_L = Line impedance.

Quarter-Wave Matching Transformers The impedance inverting characteristic of a quarter-wave section of transmission line is widely used by making such a

section of line act as a *quarter-wave transformer*. The *Johnson Q* feed system is a widely known application of the quarter-wave transformer to the feeding of a dipole antenna and array consisting of two dipoles. However, the quarter-wave transformer may be used in a wide number of applications wherever a transformer is required to match two impedances whose geometric mean is somewhere between perhaps 25 and 750 ohms when transmission line sections can be used. Paralleled coaxial lines may be used to obtain the lowest impedance mentioned, and open-wire lines composed of small conductors spaced a moderate distance may be used to obtain the higher impedance. A short list of impedances, which may be matched by quarter-wave sections of transmission line having specified impedances, is given below.

Load or Ant. Impedance ↓	300	480	600	← Feed-Line Impedance
20	77	98	110	Quarter-
30	95	120	134	Wave
50	110	139	155	Transformer
75	150	190	212	Impedance
100	173	220	245	

Johnson-Q Feed System The standard form of *Johnson-Q* feed to a doublet is shown in figure 32. An impedance match is obtained by utilizing a matching section, the surge impedance of which is the geometric mean between the transmission line surge impedance and the radiation resistance of the radiator. A sufficiently good match usu-

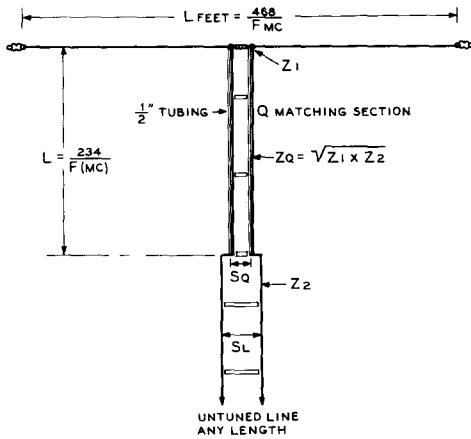

Figure 32
HALF-WAVE RADIATOR FED
BY "Q BARS"

The Q matching section is simply a quarter-wave transformer whose impedance is equal to the geometric mean between the impedance at the center of the antenna and the impedance of the transmission line to be used to feed the bottom of the transformer. The transformer may be made up of parallel tubing, a four-wire line, or any other type of transmission line which has the correct value of impedance.

ally can be obtained by either designing or adjusting the matching section for a dipole to have a surge impedance that is the geometric mean between the line impedance and 72 ohms, the latter being the theoretical radiation resistance of a half-wave doubler either infinitely high or a half wave above a perfect ground.

Though the radiation resistance may depart somewhat from 72 ohms under actual conditions, satisfactory results will be obtained with this assumed value, so long as the dipole radiator is more than a quarter wave above effective earth, and reasonably in the clear. The small degree of standing waves introduced by a slight mismatch will not increase the line losses appreciably, and any small amount of reactance present can be tuned out at the transmitter termination with no bad effects. If the reactance is objectionable, it may be minimized by making the untuned line an integral number of quarter waves long.

A Q-matched system can be adjusted precisely, if desired, by constructing a matching section to the calculated dimensions with provision for varying the spacing of the Q section conductors slightly, after the untuned line has been checked for standing waves.

Center to Center Spacing in Inches	Impedance in Ohms for 1/2" Diameters	Impedance in Ohms for 1/4" Diameters
1	170	250
1.25	188	277
1.5	207	298
1.75	225	318
2	248	335

PARALLEL TUBING SURGE IMPEDANCE FOR MATCHING SECTIONS

The Collins Transmission Line Matching System

The advantage of unbalanced output networks for transmitters are numerous; however this output system becomes awkward when it is desired to feed an antenna system utilizing a balanced input. For some time the Collins Radio Co. has been experimenting with a balun and tapered line system for matching a coaxial output transmitter to an open-wire balanced transmission line. Considerable success has been obtained and matching systems good over a frequency range as great as four to one have been developed. Illustrated in figure 33 is one type of matching system which is proving satisfactory over this range. Z_1 is the transmitter end of the system and may be any length of 52-ohm coaxial cable. Z_2 is one-quarter wavelength long at the mid-frequency of the range to be covered and is made of 75 ohm coaxial cable. Z_A is a quarter-wavelength shorted section of cable at the mid-frequency. Z_0 (Z_A and Z_2) forms a 200-ohm quarter-wave section. The Z_A section is formed of a conductor of the same diameter as Z_2 . The difference in length between Z_A and Z_2 is accounted for by the fact that Z_2 is a coaxial conductor with a solid dielectric, whereas the dielectric for Z_0 is air. Z_3 is one-quarter wavelength long at the mid-frequency and has an imped-

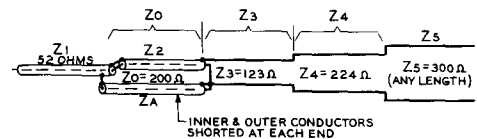

Figure 33
COLLINS TRANSMISSION LINE MATCHING SYSTEM

A wide-band system for matching a 52-ohm coaxial line to a balanced 300-ohm line over a 4:1 wide frequency range.

ance of 123 ohms. Z_4 is one-quarter wavelength long at the *mid-frequency* and has an impedance of 224 ohms. Z_5 is the balanced line to be matched (in this case 300 ohms) and may be any length.

Other system parameters for different output and input impedances may be calculated from the following:

Transformation ratio (r) for each section is:

$$r = \sqrt{\frac{N Z_{\text{out}}}{Z_{\text{in}}}}$$

Where N is the number of sections. In the above case,

$$r = \sqrt[3]{\frac{Z_5}{Z_1}}$$

Impedance between sections, as Z_{2-3} , is r times the preceding section. $Z_{2-3} = r \times Z_1$, and $Z_{3-4} = r \times Z_{2-3}$.

Mid-frequency (m):

$$m = \frac{F_1 + F_2}{2}$$

$$\text{For 40-20-10 meters} = \frac{7 + 30}{2} = 18.5 \text{ Mc.}$$

and one-quarter wavelength = 12 feet.

$$\text{For 20-10-6 meters} = \frac{14 + 54}{2} = 34 \text{ Mc.}$$

and one-quarter wavelength = 5.5 feet.

The impedances of the sections are:

$$Z_2 = \sqrt{Z_1 \times Z_{2-3}}$$

$$Z_3 = \sqrt{Z_{2-3} \times Z_{3-4}}$$

$$Z_4 = \sqrt{Z_{3-4} \times Z_5}$$

$$Z_0 = \frac{2}{3} \times Z_5$$

Generally, the larger number of taper sections the greater will be the bandwidth of the system.

22-9

Antenna Construction

The foregoing portion of this chapter has

been concerned primarily with the *electrical* characteristics and considerations of antennas. Some of the physical aspects and mechanical problems incident to the actual erection of antennas and arrays will be discussed in the following section.

Up to 60 feet, there is little point in using mast-type antenna supports unless guy wires either must be eliminated or kept to a minimum. While a little more difficult to erect, because of their floppy nature, fabricated wood poles of the type to be described will be just as satisfactory as more rigid types, *provided* many guy wires are used.

Rather expensive when purchased through the regular channels, 40- and 50-foot telephone poles sometimes can be obtained quite reasonably. In the latter case, they are hard to beat, inasmuch as they require no guying if set in the ground six feet (standard depth), and the resultant pull in any lateral direction is not in excess of a hundred pounds or so.

For heights of 80 to 100 feet, either three-sided or four-sided lattice type masts are most practicable. They can be made self-supporting, but a few guys will enable one to use a smaller cross section without danger from high winds. The torque exerted on the base of a high self-supporting mast is terrific during a strong wind.

The "A-Frame" Mast Figures 34A and 34B show the standard method of construction of the *A-frame*

type of mast. This type of mast is quite frequently used since there is only a moderate amount of work involved in the construction of the assembly and since the material cost is relatively small. The three pieces of selected 2 by 2 are first set up on three sawhorses or boxes and the holes drilled for the three $\frac{1}{4}$ -inch bolts through the center of the assembly. Then the base legs are spread out to about 6 feet and the bottom braces installed. Then the upper braces and the cross pieces are installed and the assembly given several coats of good-quality paint as a protection against weathering.

Figure 34C shows another common type of mast which is made up of sections of 2 by 4 placed end-to-end with stiffening sections of 1 by 6 bolted to the edge of the 2 by 4 sections. Both types of masts will require a set of top guys and another set of guys about one-third of the way down from the top. Two guys spaced about 90 to 100 degrees and pulling against the load of the antenna will normally be adequate for the top guys. Three guys are usually used at the lower level, with one directly behind the load of the antenna and two more spaced 120 degrees from the rear guy.

The raising of the mast is made much easier

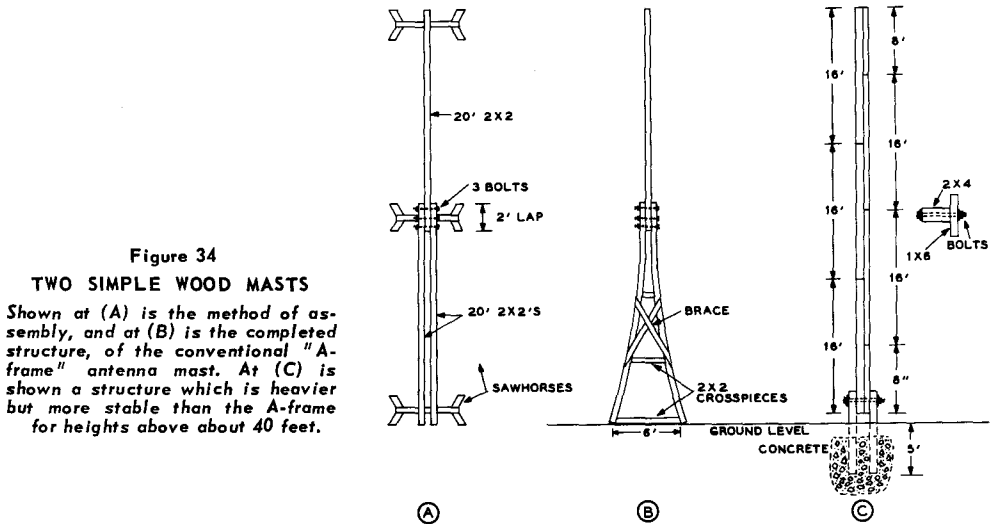

Figure 34

TWO SIMPLE WOOD MASTS

Shown at (A) is the method of assembly, and at (B) is the completed structure, of the conventional "A-frame" antenna mast. At (C) is shown a structure which is heavier but more stable than the A-frame for heights above about 40 feet.

if a gin pole about 20 feet high is installed about 30 or 40 feet to the rear of the direction in which the antenna is to be raised. A line from a pulley on the top of the gin pole is then run to the top of the pole to be raised. The gin pole comes into play when the center of the mast has been raised 10 to 20 feet above the ground and an additional elevated pull is required to keep the top of the mast coming up as the center is raised further above ground.

Using TV Masts Steel tubing masts of the telescoping variety are widely available at a moderate price for use in supporting television antenna arrays. These masts usually consist of several 10-foot lengths of electrical metal tubing (EMT) of sizes such that the sections will telescope. The 30-foot and 40-foot lengths are well suited as masts for supporting antennas and arrays of the types used on the amateur bands. The masts are constructed in such a manner that the bottom 10-foot length may be guyed permanently before the other sections are raised. Then the upper sections may be extended, beginning with the top-mast section, until the mast is at full length (provided a strong wind is not blowing) following which all the guys may be anchored. It is important that there be no load on the top of the mast when the "vertical" raising method is to be employed.

Guy Wires Guy wires should never be pulled taut; a *small* amount of slack is desirable. Galvanized wire, somewhat heavier

than seems sufficient for the job, should be used. The heavier wire is a little harder to handle, but costs only a little more and takes longer to rust through. Care should be taken to make sure that no kinks exist when the pole or tower is ready for erection, as the wire will be greatly weakened at such points if a kink is pulled tight, even if it is later straightened.

If "dead men" are used for the guy wire terminations, the wire or rod reaching from the dead men to the surface should be of non-rusting material, such as brass, or given a heavy coating of asphalt or other protective substance to prevent destructive action by the damp soil. Galvanized iron wire will last only a short time when buried in moist soil.

Only strain-type (compression) insulators should be used for guy wires. Regular ones might be sufficiently strong for the job, but it is not worth taking chances, and egg-type strain halyard insulators are no more expensive.

Only a brass or bronze pulley should be used for the halyard, as a high pole with a rusted pulley is truly a sad affair. The bearing of the pulley should be given a few drops of heavy machine oil before the pole or tower is raised. The halyard itself should be of good material, preferably water-proofed. Hemp rope of good quality is better than window sash cord from several standpoints, and is less expensive. Soaking it thoroughly in engine oil of medium viscosity, and then wiping it off with a rag, will not only extend its life but minimize shrinkage in wet weather. Because of the difficulty of replacing a broken halyard it is a good idea to replace it periodically, without

waiting for it to show excessive wear or deterioration.

It is an excellent idea to tie both ends of the halyard line together in the manner of a flag-pole line. Then the antenna is tied onto the place where the two ends of the halyard are joined. This procedure of making the halyard into a loop prevents losing the top end of the halyard should the antenna break near the end, and it also prevents losing the halyard completely should the end of the halyard carelessly be allowed to go free and be pulled through the pulley at the top of the mast by the antenna load. A somewhat longer piece of line is required but the insurance is well worth the cost of the additional length of rope.

Trees as Supports Often a tall tree can be called upon to support one end of an antenna, but one should not attempt to attach anything to the top, as the swaying of the top of the tree during a heavy wind will complicate matters.

If a tree is utilized for support, provision should be made for keeping the antenna taut without submitting it to the possibility of being severed during a heavy wind. This can be done by the simple expedient of using a pulley and halyard, with weights attached to the lower end of the halyard to keep the antenna taut. Only enough weight to avoid excessive sag in the antenna should be tied to the halyard, as the continual swaying of the tree submits the pulley and halyard to considerable wear.

Galvanized iron pipe, or steel-tube conduit, is often used as a vertical radiator, and is quite satisfactory for the purpose. However, when used for supporting antennas, it should be remembered that the grounded supporting poles will distort the field pattern of a vertically polarized antenna unless spaced some distance from the radiating portion.

Painting The life of a wood mast or pole can be increased several hundred per cent by protecting it from the elements with a coat or two of paint. And, of course, the appearance is greatly enhanced. The wood should first be given a primer coat of flat white outside house paint, which can be thinned down a bit to advantage with second-grade linseed oil. For the second coat, which should not be applied until the first is thoroughly dry, *aluminum paint* is not only the best from a preservative standpoint, but looks very well. This type of paint, when purchased in quantities, is considerably cheaper than might be gathered from the price asked for quarter-pint cans.

Portions of posts or poles below the surface of the soil can be protected from termites and moisture by painting with creosote. While not

so strong initially, redwood will deteriorate much more slowly when buried than will the white woods, such as pine.

Antenna Wire The antenna or array itself presents no especial problem. A few considerations should be borne in mind, however. For instance, soft-drawn copper should not be used, as even a short span will stretch several per cent after whipping around in the wind a few weeks, thus affecting the resonant frequency. Enameled-copper wire, as ordinarily available at radio stores, is usually soft drawn, but by tying one end to some object such as a telephone pole and the other to the frame of an auto, a few husky tugs can be given and the wire, after stretching a bit, is equivalent to hard drawn.

Where a long span of wire is required, or where heavy insulators in the center of the span result in considerable tension, copper-clad steel wire is somewhat better than hard-drawn copper. It is a bit more expensive, though the cost is far from prohibitive. The use of such wire, in conjunction with strain insulators, is advisable, where the antenna would endanger persons or property should it break.

For transmission lines and tuning stubs steel-core or hard-drawn wire will prove awkward to handle, and soft-drawn copper should, therefore, be used. If the line is long, the strain can be eased by supporting it at several points.

More important from an electrical standpoint than the actual size of wire used is the soldering of joints, especially at current loops in an antenna of low radiation resistance. In fact, it is good practice to solder *all* joints, thus insuring quiet operation when the antenna is used for receiving.

Insulation A question that often arises is that of insulation. It depends, of course, upon the r-f voltage at the point at which the insulator is placed. The r-f voltage, in turn, depends upon the distance from a current node, and the radiation resistance of the antenna. Radiators having low radiation resistance have very high voltage at the voltage loops; consequently, better than usual insulation is advisable at those points.

Open-wire lines operated as non-resonant lines have little voltage across them; hence the most inexpensive ceramic types are sufficiently good electrically. With tuned lines, the voltage depends upon the amplitude of the standing waves. If they are very great, the voltage will reach high values at the voltage loops, and the best spacers available are none too good. At the current loops the voltage is quite low, and almost anything will suffice.

When insulators are subject to very high r-f voltages, they should be cleaned occasionally if in the vicinity of sea water or smoke. Salt scum and soot are not readily dislodged by rain, and when the coating becomes heavy enough, the efficiency of the insulators is greatly impaired.

If a very pretentious installation is to be made, it is wise to check up on both underwriter's rules and local ordinances which might be applicable. If you live anywhere near an airport, and are contemplating a tall pole, it is best to investigate possible regulations and ordinances pertaining to towers in the district, before starting construction.

22-10 Coupling to the Antenna System

When coupling an antenna feed system to a transmitter the most important considerations are as follows: (1) means should be provided for varying the load on the amplifier; (2) the two tubes in a push-pull amplifier should be equally loaded; (3) the load presented to the final amplifier should be resistive (non-reactive) in character; and (4) means should be provided to reduce harmonic coupling between the final amplifier plate tank circuit and the antenna or antenna transmission line to an extremely low value.

The Transmitter-Loading Problem The problem of coupling the power output of a high-frequency or v-h-f transmitter to the radiating portion of the antenna system has been materially complicated by the virtual necessity for eliminating interference to TV reception. However, the TVI-elimination portion of the problem may always be accomplished by adequate shielding of the transmitter, by filtering of the control and power leads which enter the transmitter enclosure, and by the inclusion of a harmonic-attenuating filter be-

tween the output of the transmitter and the antenna system.

Although TVI may be eliminated through inclusion of a filter between the output of a shielded transmitter and the antenna system, the fact that such a filter must be included in the link between transmitter and antenna makes it necessary that the transmitter-loading problem be re-evaluated in terms of the necessity for inclusion of such a filter.

Harmonic-attenuating filters must be operated at an impedance level which is close to their design value; therefore they must operate into a resistive termination substantially equal to the characteristic impedance of the filter. If such filters are operated into an impedance which is not resistive and approximately equal to their characteristic impedance: (1) the capacitors used in the filter sections will be subjected to high peak voltages and may be damaged, (2) the harmonic-attenuating properties of the filter will be decreased, and (3) the impedance at the input end of the filter will be different from that seen by the filter at the load end (except in the case of the half-wave type of filter). It is therefore important that the filter be included in the transmitter-to-antenna circuit at a point where the impedance is close to the nominal value of the filter, and at a point where this impedance is likely to remain fairly constant with variations in frequency.

Block Diagrams of Transmitter-to-Antenna Coupling Systems There are two basic arrangements which include all the provisions required in the transmitter-to-antenna coupling system, and which permit the harmonic-attenuating filter to be placed at a position in the coupling system where it can be operated at an impedance level close to its nominal value. These arrangements are illustrated in block-diagram form in figures 35 and 36.

The arrangement of figure 35 is recommended for use with a single-band antenna system, such as a dipole or a rotatable array, wherein an impedance matching system is included

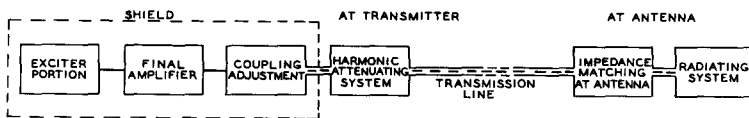

Figure 35 ANTENNA COUPLING SYSTEM

The harmonic suppressing antenna coupling system illustrated above is for use when the antenna transmission line has a low standing-wave ratio, and when the characteristic impedance of the antenna transmission line is the same as the nominal impedance of the low-pass harmonic-attenuating filter.

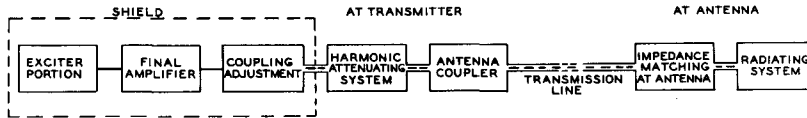

Figure 36

ANTENNA COUPLING SYSTEM

The antenna coupling system illustrated above is for use when the antenna transmission line does not have the same characteristic impedance as the TVI filter, and when the standing-wave ratio on the antenna transmission line may or may not be low.

within or adjacent to the antenna. The feed line coming down from the antenna system should have a characteristic impedance equal to the nominal impedance of the harmonic filter, and the impedance matching at the antenna should be such that the standing-wave ratio on the antenna feed line is less than 2 to 1 over the range of frequency to be fed to the antenna. Such an arrangement may be used with open-wire line, ribbon or tubular line, or with coaxial cable. The use of coaxial cable is to be recommended, but in any event the impedance of the antenna transmission line should be the same as the nominal impedance of the harmonic filter. The arrangement of figure 35 is more or less standard for commercially manufactured equipment for amateur and commercial use in the h-f and v-h-f range.

The arrangement of figure 36 merely adds an antenna coupler between the output of the harmonic attenuating filter and the antenna transmission line. The antenna coupler will have some harmonic-attenuating action, but its main function is to transform the impedance at the station end of the antenna transmission line to the nominal value of the harmonic filter. Hence the arrangement of figure 36 is more general than the figure 35 system, since the inclusion of the antenna coupler allows the system to feed an antenna transmission line of any reasonable impedance value, and also without regard to the standing-wave ratio which might exist on the antenna transmission line. Antenna couplers are discussed in a following section.

Output Coupling Adjustment It will be noticed by reference to both figure 35 and figure 36 that a box labeled

Coupling Adjustment is included in the block diagram. Such an element is necessary in the complete system to afford an adjustment in the value of load impedance presented to the tubes in the final amplifier stage of the transmitter. The impedance at the input terminal of the harmonic filter is established by the antenna, through its matching system and the antenna

coupler, if used. In any event the impedance at the input terminal of the harmonic filter should be very close to the nominal impedance of the filter. Then the Coupling Adjustment provides means for transforming this impedance value to the correct operating value of load impedance which should be presented to the final amplifier stage.

There are two common ways for accomplishing the antenna coupling adjustment, as illustrated in figures 37 and 38. Figure 37 shows the variable-link arrangement most commonly used in home-constructed equipment, while the pi-network coupling arrangement commonly used in commercial equipment is illustrated in figure 38. Either method may be used, and each has its advantages.

Variable-Link Coupling The variable-link method illustrated in figure 37 has the advantage that standard manufactured components may be used with no changes. However, for greatest bandwidth of operation of the coupling circuit, the reactance of the link coil, L , and the reactance of the link tuning capacitor, C , should both be between 3 and 4 times the nominal load impedance of the harmonic filter. This is to say that the inductive reactance of the coupling link L should be tuned out or resonated by capacitor C , and the operating Q of the L - C link circuit should be between 3 and 4. If the link coil is not variable with respect to the tank coil of the final amplifier, capacitor C may be used as a loading control; however, this system is not recommended since its use will require adjustment of C whenever a frequency change is made at the transmitter. If L and C are made resonant at the center of a band, with a link circuit Q of 3 to 4, and coupling adjustment is made by physical adjustment of L with respect to the final amplifier tank coil, it usually will be possible to operate over an entire amateur band without change in the coupling system. Capacitor C normally may have a low voltage rating, even with a high power transmitter, due to the low Q and low impedance of the coupling circuit.

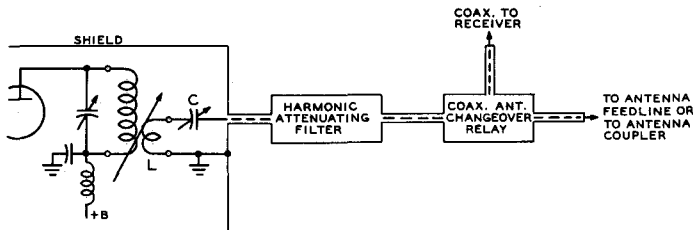

Figure 37
TUNED-LINK OUTPUT CIRCUIT

Capacitor C should be adjusted so as to tune out the inductive reactance of the coupling link, L. Loading of the amplifier then is varied by physically varying the coupling between the plate tank of the final amplifier and the antenna coupling link,

Pi-Network Coupling The pi-network coupling system offers two advantages: (1) a mechanical coupling variation is not required to vary the loading of the final amplifier, and (2) the pi network (if used with an operating Q of about 15) offers within itself a harmonic attenuation of 40 db or more, in addition to the harmonic attenuation provided by the additional harmonic attenuating filter. Some commercial equipments (such as the Collins amateur transmitters) incorporate an L network in addition to the pi network, for accomplishing the impedance transformation in two steps and to provide additional harmonic attenuation.

Tuning the Pi-Section Coupler Tuning of a pi-network coupling circuit such as illustrated in figure 38 is accomplished in the following manner: First remove the connection between the output of the amplifier and the harmonic filter (load). Tune C₂ to a capacitance which is large for the band in use, adding suitable additional ca-

pacitance by switch S if operation is to be on one of the lower frequency bands. Apply reduced plate voltage to the stage and dip to resonance with C₁. It may be necessary to vary the inductance in coil L, but in any event resonance should be reached with a setting of C₁ which is approximately correct for the desired value of operating Q of the pi network.

Next, couple the load to the amplifier (through the harmonic filter), apply reduced plate voltage again and dip to resonance with C₁. If the plate current dip with load is too low (taking into consideration the reduced plate voltage), decrease the capacitance of C₂ and again dip to resonance, repeating the procedure until the correct value of plate current is obtained with full plate voltage on the stage. There should be a relatively small change required in the setting of C₁ (from the original setting of C₁ without load) if the operating Q of the network is correct and if a large value of impedance transformation is being employed—as would be the case when transforming from the plate impedance of a single-

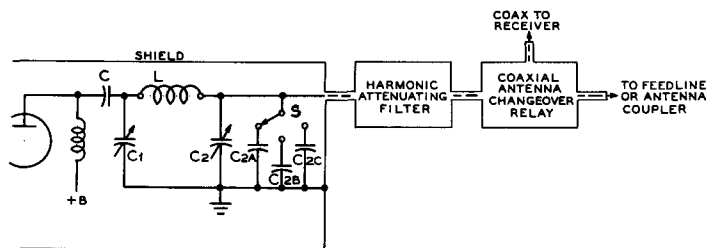

Figure 38
PI-NETWORK ANTENNA COUPLER

The design of pi-network output circuits is discussed in Chapter Thirteen. The additional output-end shunting capacitors selected by switch S are for use on the lower frequency ranges. Inductor L may be selected by a tap switch, it may be continuously variable, or plug-in inductors may be used.

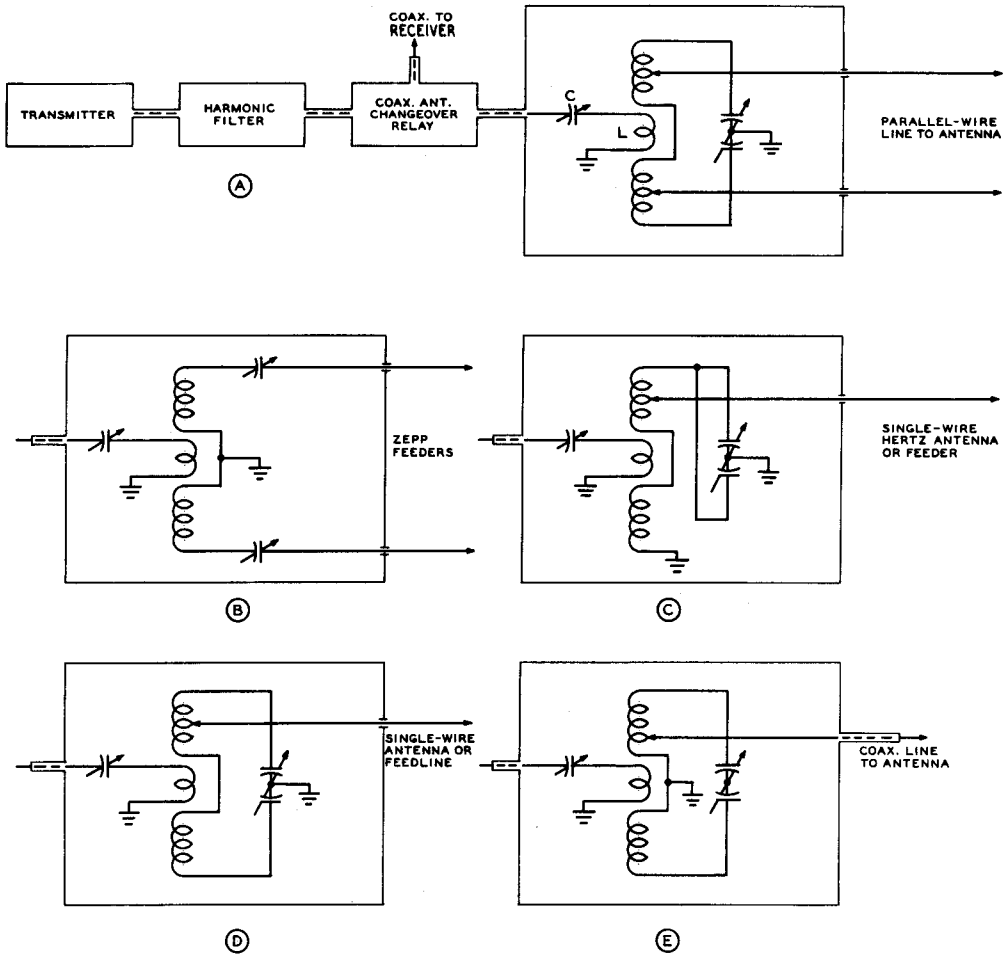

Figure 39

ALTERNATIVE ANTENNA-COUPLER CIRCUITS

Plug-in coils, one or two variable capacitors of the split-stator variety, and a system of switches or plugs and jacks may be used in the antenna coupler to accomplish the feeding of different types of antennas and antenna transmission lines from the coaxial input line from the transmitter or from the antenna changeover relay. Link L should be resonated with capacitor C at the operating frequency of the transmitter so that the harmonic filter will operate into a resistive load impedance of the correct nominal value.

ended output stage down to the 50-ohm impedance of the usual harmonic filter and its subsequent load.

In a pi network of this type the harmonic attenuation of the section will be adequate when the correct value of C_1 and L are being used and when the resonant dip in C_1 is sharp. If the dip in C_1 is broad, or if the plate current persists in being too high with C_2 at maximum setting, it means that a *greater* value

of capacitance is required at C_2 , assuming that the values of C_1 and L are correct.

22-11 Antenna Couplers

As stated in the previous section, an antenna coupler is not required when the impedance of the antenna transmission line is the same as the nominal impedance of the harmonic fil-

ter, assuming that the antenna feed line is being operated with a low standing-wave ratio. However, there are many cases where it is desirable to feed a multi-band antenna from the output of the harmonic filter, where a tuned line is being used to feed the antenna, or where a long wire without a separate feed line is to be fed from the output of the harmonic filter. In such cases an *antenna coupler* is required.

Some harmonic attenuation will be provided by the antenna coupler, particularly if it is well shielded. In certain cases when a pi network is being used at the output of the transmitter, the addition of a shielded antenna coupler will provide sufficient harmonic attenuation. But in all normal cases it will be necessary to include a harmonic filter between the output of the transmitter and the antenna coupler. When an adequate harmonic filter is being used, it will not be necessary in normal cases to shield the antenna coupler, except from the standpoint of safety or convenience.

Function of an Antenna Coupler The function of the antenna coupler is, basically, to transform the impedance of the antenna system being used to the correct value of *resistive* impedance for the harmonic filter, and hence for the transmitter. Thus the antenna coupler may be used to resonate the feeders or the radiating portion of the antenna system, in addition to its function of impedance transformation.

It is important to remember that there is *nothing* that can be done at the antenna coupler which will eliminate standing waves on the antenna transmission line. Standing waves are the result of reflection from the antenna, and the coupler can do nothing about this condition. However, the antenna coupler can resonate the feed line (by introducing a conjugate impedance) in addition to providing an impedance transformation. Thus, a resistive impedance of the correct value can be presented to the harmonic filter, as in figure 36, regardless of any *reasonable* value of standing-wave ratio on the antenna transmission line.

Types of Antenna Couplers All usual types of antenna couplers fall into two classifications: (1) inductively coupled resonant systems as exemplified by those shown in figure 39, and (2) conductively coupled pi-network systems such as shown in figure 40. The inductively-coupled system is much more commonly used, since it is convenient for feeding a balanced line from the coaxial output of the usual harmonic filter. The pi-network system is most useful for feeding a length of wire from the output of a transmitter.

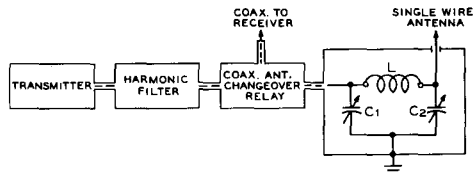

Figure 40
PI-NETWORK
ANTENNA COUPLER

An arrangement such as illustrated above is convenient for feeding an end-fed Hertz antenna, or a random length of wire for portable or emergency operation, from the nominal value of impedance of the harmonic filter.

Several general methods for using the inductively-coupled resonant type of antenna coupler are illustrated in figure 39. The coupling between the link coil L and the main tuned circuit need not be variable; in fact it is preferable that the correct link size and placement be determined for the tank coil which will be used for each band, and then that the link be made a portion of the plug-in coil. Capacitor C then can be adjusted to a pre-determined value for each band such that it will resonate with the link coil for that band. The reactance of the link coil (and hence the reactance of the capacitor setting which will resonate the coil) should be about 3 or 4 times the impedance of the transmission line between the antenna coupler and the harmonic filter, so that the link coupling circuit will have an operating Q of 3 or 4. The use of capacitor C to resonate with the inductance of the link coil L will make it easier to provide a low standing-wave ratio to the output of the harmonic filter, simply by adjustment of the antenna-coupler tank circuit to resonance. If this capacitor is not included, the system still will operate satisfactorily, but the tank circuit will have to be detuned slightly from resonance so as to cancel the inductive reactance of the coupling link and thus provide a resistive load to the output of the harmonic filter. Variations in the loading of the final amplifier should be made by the coupling adjustment at the final amplifier, not at the antenna coupler.

The pi-network type of antenna coupler, as shown in figure 40 is useful for certain applications, but is primarily useful in feeding a single-wire antenna from a low-impedance transmission line. In such an application the operating Q of the pi network may be somewhat lower than that of a pi network in the plate circuit of the final amplifier of a transmitter, as shown in figure 38. An operating Q of 3 or 4

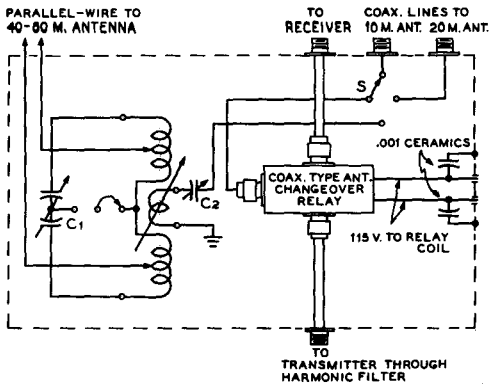

Figure 41
ALTERNATIVE COAXIAL ANTENNA
COUPLER

This circuit is recommended not only as being most desirable when coaxial lines with low s.w.r. are being used to feed antenna systems such as rotatable beams, but when it also is desired to feed through open-wire line to some sort of multi-band antenna for the lower frequency ranges. The tuned circuit of the antenna coupler is operative only when using the open-wire feed, and then it is in operation both for transmit and receive.

in such an application will be found to be adequate, since harmonic attenuation has been accomplished ahead of the antenna coupler. However, the circuit will be easier to tune, although it will not have as great a bandwidth, if the operating Q is made higher.

An alternative arrangement shown in figure 41 utilizes the antenna coupling tank circuit only when feeding the coaxial output of the transmitter to the open-wire feed line (or similar multi-band antenna) of the 40-80 meter antenna. The coaxial lines to the 10-meter beam and to the 20-meter beam would be fed directly from the output of the coaxial antenna changeover relay through switch S.

22-12 A Single-Wire Antenna Tuner

One of the simplest and least expensive antennas for transmission and reception is the single wire, end-fed Hertz antenna. When used over a wide range of frequencies, this type of antenna exhibits a very great range of input impedance. At the low frequency end of the spectrum such an antenna may present a resistive load of less than one ohm to the transmitter, combined with a large positive or negative value of reactance. As the frequency of operation is raised, the resistive load may

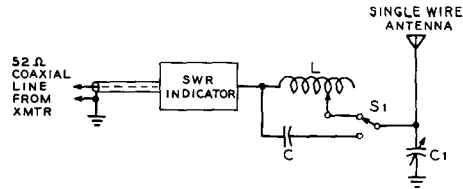

Figure 42

ANTENNA TUNER AND SWR
INDICATOR FOR RANDOM
LENGTH HERTZ ANTENNA

rise to several thousand ohms (near half-wave resonance) and the reactive component of the load can rapidly change from positive to negative values, or vice-versa.

It is possible to match an antenna at almost any frequency between 1.8 mc and 30 mc with the use of a simple tuner of the type shown in figure 42. A variable series inductor L, and a variable shunt capacitor C1 permit circuit resonance and impedance transformation to be established for most antenna lengths. Switch S1 permits the selection of series capacitor C for those instances when the single wire antenna exhibits large values of positive reactance.

To provide indication for the tuning of the network, a radio frequency bridge (SWR meter) is included to indicate the degree of mismatch (standing wave ratio) existing at the input to the tuner. All adjustments to the tuner are made with the purpose of reaching unity standing wave ratio on the coaxial feed system between the tuner and the transmitter.

A Practical Antenna Tuner A simple antenna tuner for use with transmitters of 250 watts power or less is shown in figures 43 through 46. A SWR bridge circuit is used to indicate tuner resonance. The resistive arm of the bridge consists of ten 10-ohm, 1-watt carbon resistors connected in parallel to form a 1-ohm resistor (R1). The other pair of bridge arms are capacitive rather than resistive. The bridge detector is a simple r-f voltmeter employing a 1N56 crystal diode and a 0-1 d.c. milliammeter. A sensitivity control is incorporated to prevent overloading the meter when power is first applied to the tuner. Final adjustments are made with the sensitivity control at its maxi-

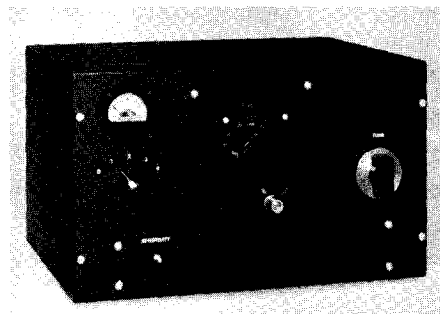
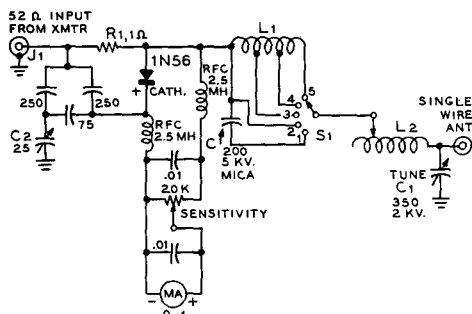

Figure 43
ANTENNA TUNER IS HOUSED
IN METAL CABINET 7" x 8" IN
SIZE.

Inductance switch S1 and sensitivity control are at left with counter dial for L2 at center. Output tuning capacitor C1 is at right. SWR meter is mounted above S1.



L1-35 TURNS #18, 2" DIA.,
3.5" LONG (AIR-DUX)
TAP AT 15 T., 27 T.,
FROM POINT A

L2-JOHNSON 229-201 VARIABLE
INDUCTOR (10 MH)

C1-JOHNSON 35DE20

C2-CENTRALAB TYPE 822

J1-TYPE 50-239 RECEPTACLE

R1-TEN 10-OHM 1-WATT CARBON
RESISTORS IN PARALLEL. 1RC TYPE BTA

Figure 44
SCHEMATIC, SINGLE-WIRE
ANTENNA TUNER

imum (clockwise) position. The bridge is balanced when the input impedance of the tuner is 52 ohms resistive. This is the condition for maximum energy transfer between transmission line and antenna. The meter is graduated in arbitrary units, since actual SWR value is not required.

Tuner Construction Major parts placement in the tuner is shown in figures 43 and 45. Tapped coil L1 is mounted upon 1/2-inch ceramic insulators, and all major components are mounted above deck with the exception of the SWR bridge (figure 46). The components of the bridge are placed below deck, adjacent to the coaxial input plug mounted on the rear apron of the chassis. The ten 10-ohm resistors are soldered to two 1-inch rings made of copper wire as shown in the photograph. The bridge capacitors are attached to this assembly with extremely short leads. The 1N56 crystal mounts at right angles to the resistors to insure minimum amount of capacitive coupling between the resistors and the detector. The output lead from the bridge passes through a ceramic feed-thru insulator to the top side of the chassis.

Connection to the antenna is made by means of a large feedthru insulator mounted on the back of the tuner cabinet. This insulator is not visible in the photographs.

Bridge Calibration

The SWR bridge must be calibrated for 52 ohm service. This can be done by temporarily disconnecting the lead between the bridge and the antenna tuner and connecting a 2-watt, 52 ohm carbon resistor to the junction of R1 and the negative terminal of the 1N56 diode. The opposite lead of the carbon resistor is grounded to the chassis of the bridge. A small amount of r-f energy is fed to the input of the bridge until a reading is obtained on the r-f voltmeter. The 25 mmfd bridge balancing capacitor C2 (see figure 46) is then adjusted with a fibre-blade screwdriver until a zero reading is obtained on the meter. The sensitivity control is advanced as the meter null grows, in order to obtain the exact point of bridge balance. When this point is found, the carbon resistor should be removed and the bridge attached to the antenna tuner. The bridge capacitor is sealed with a drop of nail polish to prevent misadjustment.

Tuner Adjustments

All tuning adjustments are made to obtain proper transmitter loading with a balanced (zero meter reading) bridge condition. The tuner is connected to the transmitter through a random length of 52 ohm coaxial line, and the single wire antenna is attached to the output terminal of the tuner. Transmitter loading controls are set to approximate a 52

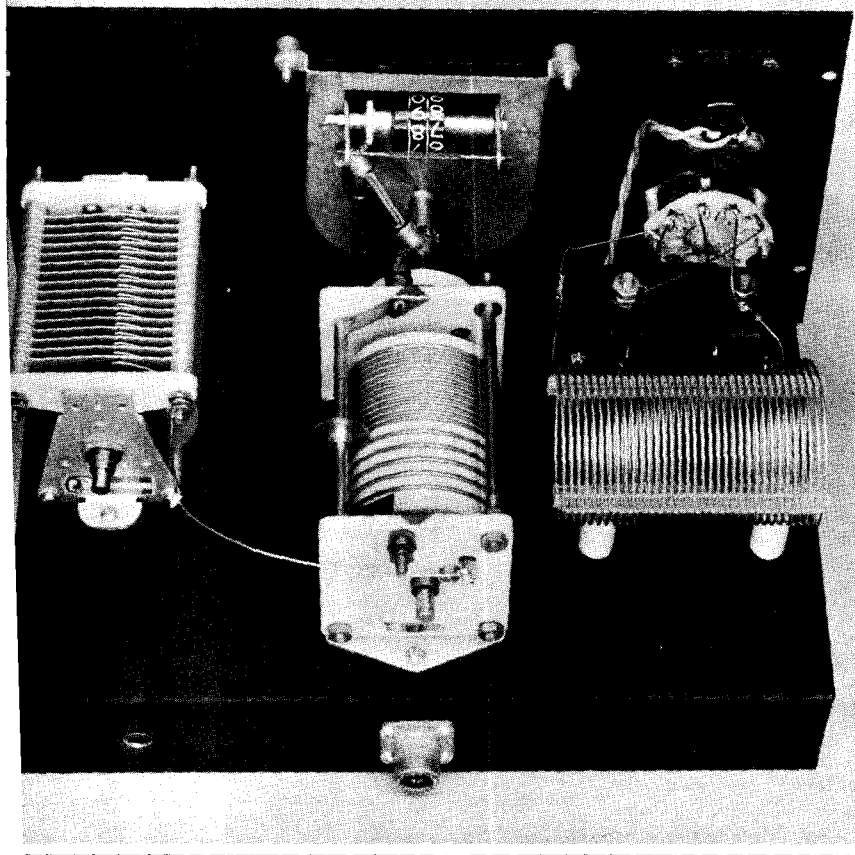

Figure 45

**REAR VIEW OF
TUNER SHOWING
PLACEMENT OF
MAJOR COMPONENTS.**

Rotary inductor is driven by Johnson 116-208-4 counter dial. Coaxial input receptacle J1 is mounted directly below rotary inductor.

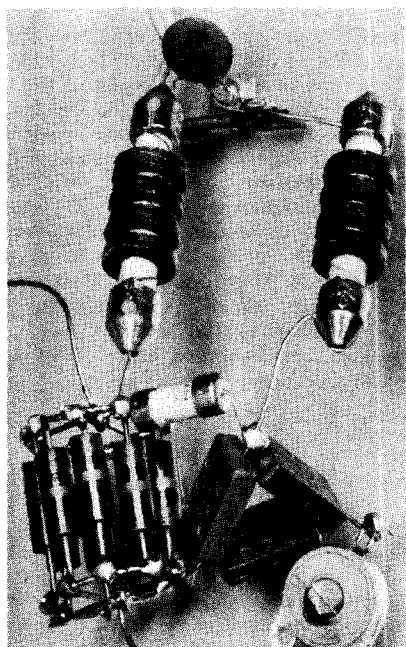

Figure 46

CLOSE-UP OF SWR BRIDGE

Simple SWR bridge is mounted below the chassis of the tuner. Carbon resistors are mounted to two copper rings to form low inductance one-ohm resistor. Bridge capacitors form triangular configuration for lowest lead inductance. Balancing capacitor C2 is at lower right.

ohm termination. The transmitter is turned on (preferably at reduced input) and resonance is established in the amplifier tank circuit. The sensitivity control of the tuner is adjusted to provide near full scale deflection on the bridge meter. Various settings of S1, L2, and C1 should be tried to obtain a reduction of bridge reading. As tuner resonance is approached, the meter reading will decrease and the sensitivity control should be advanced. When the system is in resonance, the meter will read zero. All loading adjustments may then be made with the transmitter controls. The tuner should be readjusted whenever the frequency of the transmitter is varied by an appreciable amount.

High Frequency Antenna Arrays

It is becoming of increasing importance in most types of radio communication to be capable of concentrating the radiated signal from the transmitter in a certain desired direction and to be able to discriminate at the receiver against reception from directions other than the desired one. Such capabilities involve the use of directive antenna arrays.

Few simple antennas, except the single vertical element, radiate energy equally well in all azimuth (horizontal or compass) directions. All horizontal antennas, except those specifically designed to give an omnidirectional azimuth radiation pattern such as the turnstile, have some directive properties. These properties depend upon the length of the antenna in wavelengths, the height above ground, and the slope of the radiator.

The various forms of the half-wave horizontal antenna produce maximum radiation at right angles to the wire, but the directional effect is not great. Nearby objects also minimize the directivity of a dipole radiator, so that it hardly seems worth while to go to the trouble to rotate a simple half-wave dipole in an attempt to improve transmission and reception in any direction.

The half-wave doublet, folded dipole, zepp, single-wire-fed, matched impedance, and Johnson Q antennas all have practically the same radiation pattern *when properly built and ad-*

justed. They all are dipoles, and the feeder system, if it does not radiate in itself, will have no effect on the radiation pattern.

23-1 Directive Antennas

When a multiplicity of radiating elements is located and phased so as to reinforce the radiation in certain desired directions and to neutralize radiation in other directions, a *directive antenna array* is formed.

The function of a directive antenna when used for transmitting is to give an increase in signal strength in some direction at the expense of radiation in other directions. For reception, one might find useful an antenna giving little or no gain in the direction from which it is desired to receive signals if the antenna is able to discriminate against interfering signals and static arriving from other directions. A good directive transmitting antenna, however, can also be used to good advantage for reception.

If radiation can be confined to a narrow beam, the signal intensity can be increased a great many times in the desired direction of transmission. This is equivalent to increasing the power output of the transmitter. On the higher frequencies, it is more economical to

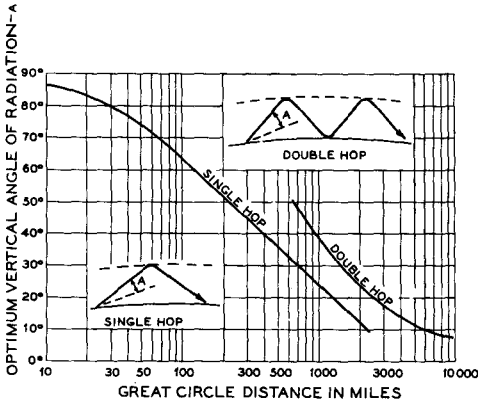

Figure 1
OPTIMUM ANGLE OF RADIATION WITH RESPECT TO DISTANCES

Shown above is a plot of the optimum angle of radiation for one-hop and two-hop communication. An operating frequency close to the optimum working frequency for the communication distance is assumed.

use a directive antenna than to increase transmitter power, if more than a few watts of power is being used.

Directive antennas for the high-frequency range have been designed and used commercially with gains as high as 23 db over a simple dipole radiator. Gains as high as 35 db are common in direct-ray microwave communication and radar systems. A gain of 23 db represents a power gain of 200 times and a gain of 35 db represents a power gain of almost 3500 times. However, an antenna with a gain of only 15 to 20 db is so sharp in its radiation pattern that it is usable to full advantage only for point-to-point work.

The increase in radiated power in the desired direction is obtained at the expense of radiation in the undesired directions. Power gains of 3 to 12 db seem to be most practicable for amateur communication, since the width of a beam with this order of power gain is wide enough to sweep a fairly large area. Gains of 3 to 12 db represent effective transmitter power increases from 2 to 16 times.

Horizontal Pattern vs. Vertical Angle There is a certain optimum vertical angle of radiation for sky-wave communication, this angle being dependent upon distance, frequency, time of day, etc. Energy radiated at an angle much lower than this optimum angle is largely lost, while radiation at angles much

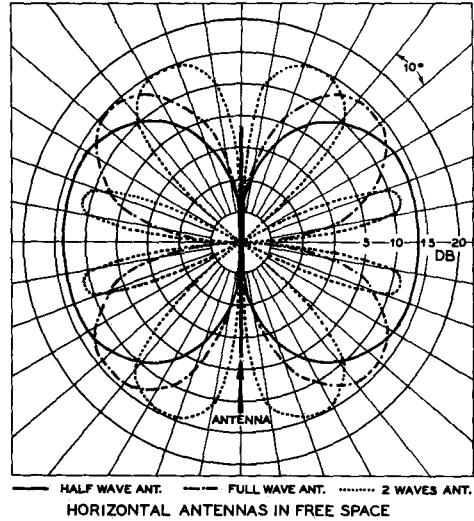

Figure 2
FREE-SPACE FIELD PATTERNS OF LONG-WIRE ANTENNAS

The presence of the earth distorts the field pattern in such a manner that the azimuth pattern becomes a function of the elevation angle.

higher than this optimum angle oftentimes is not nearly so effective.

For this reason, the horizontal directivity pattern as measured on the ground is of no import when dealing with frequencies and distances dependent upon sky-wave propagation. It is the horizontal directivity (or gain or discrimination) measured at the most useful vertical angles of radiation that is of consequence. The horizontal radiation pattern, as measured on the ground, is considerably different from the pattern obtained at a vertical angle of 15°, and still more different from a pattern obtained at a vertical angle of 30°. In general, the energy which is radiated at angles higher than approximately 30° above the earth is effective at any frequency only for local work.

For operation at frequencies in the vicinity of 14 Mc., the most effective angle of radiation is usually about 15° above the horizon, from any kind of antenna. The most effective angles for 10-meter operation are those in the vicinity of 10°. Figure 1 is a chart giving the optimum vertical angle of radiation for sky-wave propagation in terms of the great-circle distance between the transmitting and receiving antennas.

Figure 3
DIRECTIVE GAIN OF
LONG-WIRE ANTENNAS

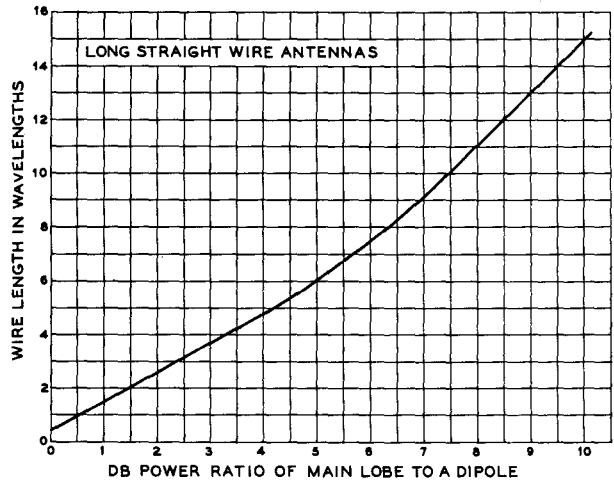

Types of Directive Arrays There is an enormous variety of directive antenna arrays that can give a substantial power gain in the desired direction of transmission or reception. However, some are more effective than others requiring the same space. In general it may be stated that long-wire antennas of various types, such as the single long wire, the V beam, and the rhombic, are less effective for a given space than arrays composed of resonant elements, but the long-wire arrays have the significant advantage that they may be used over a relatively large frequency range while resonant arrays are usable only over a quite narrow frequency band.

23-2 Long Wire Radiators

Harmonically operated long wires radiate better in certain directions than others, but cannot be considered as having appreciable directivity unless several wavelengths long. The current in adjoining half-wave elements flows in opposite directions at any instant, and thus, the radiation from the various elements adds in certain directions and cancels in others.

A half-wave doublet in free space has a "doughnut" of radiation surrounding it. A full wave has 2 lobes, 3 half waves 3, etc. When the radiator is made more than 4 half wavelengths long, the *end* lobes (cones of radiation) begin to show noticeable power gain over a half-wave doublet, while the broadside lobes get smaller and smaller in amplitude, even though numerous (figure 2).

The horizontal radiation pattern of such antennas depends upon the vertical angle of radiation being considered. If the wire is more than 4 wavelengths long, the maximum radiation at vertical angles of 15° to 20° (useful for dx) is in line with the wire, being slightly greater a few degrees either side of the wire than directly off the ends. The directivity of the main lobes of radiation is not particularly sharp, and the minor lobes fill in between the main lobes to permit working stations in nearly all directions, though the power radiated broadside to the radiator will not be great if the radiator is more than a few wavelengths long. The directive gain of long-wire antennas, in terms of the wire length in wavelengths is given in figure 3.

To maintain the out-of-phase condition in adjoining half-wave elements throughout the length of the radiator, it is necessary that a harmonic antenna be fed either at *one end* or at a *current* loop. If fed at a voltage loop, the adjacent sections will be fed *in* phase, and a different radiation pattern will result.

The directivity of a long wire does not increase very much as the length is increased beyond about 15 wavelengths. This is due to the fact that all long-wire antennas are adversely affected by the r-f resistance of the wire, and because the current amplitude begins to become unequal at different current loops, as a result of attenuation along the wire caused by radiation and losses. As the length is increased, the tuning of the antenna becomes quite broad. In fact, a long wire about 15 waves long is practically aperiodic, and works almost equally well over a wide range of frequencies.

LONG-ANTENNA DESIGN TABLE								
APPROXIMATE LENGTH IN FEET — END-FED ANTENNAS								
FREQUENCY IN MC.	1λ	1½λ	2λ	2½λ	3λ	3½λ	4λ	4½λ
2.9	33	50	67	84	101	118	135	152
2.8	34	52	69	87	104	122	140	157
2.1.4	45	68	91 1/2	114 1/2	138 1/2	160 1/2	185 1/2	209 1/2
2.1.2	45 1/4	68 1/4	91 3/4	114 3/4	138 3/4	160 3/4	185 3/4	209 3/4
2.1.0	45 1/2	68 1/2	92	115	137	161	186	210
14.2	67 1/2	102	137	171	206	240	275	310
14.0	68 1/2	103 1/2	139	174	209	244	279	314
7.3	136	206	276	346	416	486	555	625
7.15	136 1/2	207	277	347	417	487	557	627
7.0	137	207 1/2	277 1/2	348	418	488	558	628
4.0	240	362	485	618	730	853	977	1100
3.8	252	381	511	640	770	900	1030	1160
3.6	266	403	540	676	812	950	1090	1220
3.5	274	414	555	696	835	977	1120	
2.0	460	725	972	1230	1475			
1.9	504	763	1020	1280				
1.8	532	805	1080					

One of the most practical methods of feeding a long-wire antenna is to bring one end of it into the radio room for direct connection to a tuned antenna circuit which is link-coupled through a harmonic-attenuating filter to the transmitter. The antenna can be tuned effectively to resonance for operation on any harmonic by means of the tuned circuit which is connected to the end of the antenna. A ground is sometimes connected to the center of the tuned coil.

If desired, the antenna can be opened and current-fed at a point of maximum current by means of low-impedance ribbon line, or by a quarter-wave matching section and open line.

23-3 The V Antenna

If two long-wire antennas are built in the

form of a V, it is possible to make two of the maximum lobes of one leg shoot in the same direction as two of the maximum lobes of the other leg of the V. The resulting antenna is bidirectional (two opposite directions) for the main lobes of radiation. Each side of the V can be made any odd or even number of quarter wavelengths, depending on the method of feeding the apex of the V. The complete system must be a multiple of half waves. If each leg is an even number of quarter waves long, the antenna must be voltage-fed at the apex; if an odd number of quarter waves long, current feed must be used.

By choosing the proper apex angle, figure 4 and figure 5, the lobes of radiation from the two long-wire antennas aid each other to form a bidirectional beam. Each wire by itself would have a radiation pattern similar to that

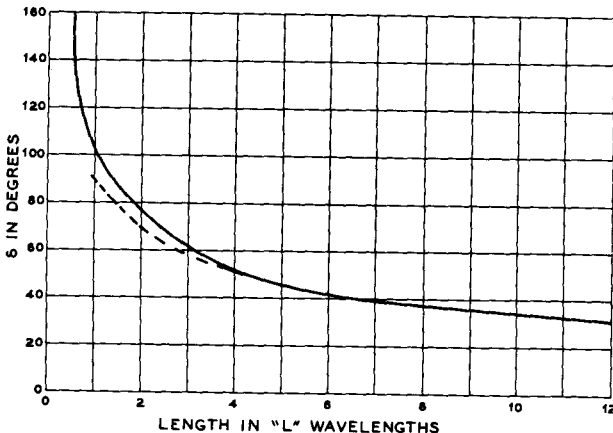

Figure 4
INCLUDED ANGLE FOR A
"V" BEAM

Showing the included angle between the legs of a V beam for various leg lengths. For optimum alignment of the radiation lobe at the correct vertical angle with leg lengths less than three wavelengths, the optimum included angle is shown by the dashed curve.

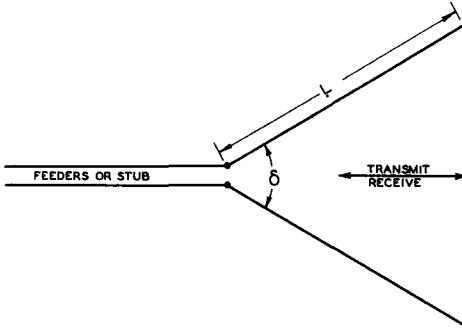

Figure 5
TYPICAL "V" BEAM ANTENNA

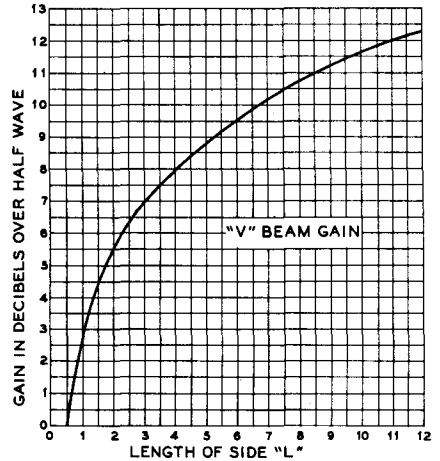

Figure 6
DIRECTIVE GAIN OF A "V" BEAM

This curve shows the approximate directive gain of a V beam with respect to a half-wave antenna located the same distance above ground, in terms of the side length L.

for a long wire. The reaction of one upon the other removes two of the four main lobes, and increases the other two in such a way as to form two lobes of still greater magnitude.

The correct wire lengths and the degree of the angle δ are listed in the *V-Antenna Design Table* for various frequencies in the 10-, 20- and 40-meter amateur bands. Apex angles for all side lengths are given in figure 4. The gain of a "V" beam in terms of the side length when optimum apex angle is used is given in figure 6.

The legs of a very long V antenna are usually so arranged that the included angle is twice the angle of the major lobe from a single wire if used alone. This arrangement concentrates the radiation of each wire along the bisector of the angle, and permits part of the other lobes to cancel each other.

With legs shorter than 3 wavelengths, the best directivity and gain are obtained with a somewhat smaller angle than that determined by the lobes. Optimum directivity for a one-wave V is obtained when the angle is 90°

rather than 180° , as determined by the ground pattern alone.

If very long wires are used in the V, the angle between the wires is almost unchanged when the length of the wires in wavelengths is altered. However, an error of a few degrees causes a much larger loss in directivity and gain in the case of the longer V than in the shorter one.

The vertical angle at which the wave is best transmitted or received from a horizontal V antenna depends largely upon the included angle. The sides of the V antenna should be at least a half wavelength above ground; commercial practice dictates a height of approximately a full wavelength above ground.

V-ANTENNA DESIGN TABLE				
FREQUENCY IN KILOCYCLES	$L = \lambda$ $\delta = 90^\circ$	$L = 2\lambda$ $\delta = 70^\circ$	$L = 4\lambda$ $\delta = 52^\circ$	$L = 8\lambda$ $\delta = 39^\circ$
28000	34'8"	69'8"	140'	280'
29000	33'6"	67'3"	135'	271'
21100	45'9"	91'9"	183'	366'
21300	45'4"	91'4"	182'6"	365'
14050	69'	139'	279'	558'
14150	68'6"	138'	277'	555'
14250	68'2"	137'	275'	552'
7020	138'2"	278'	558'	1120'
7100	136'8"	275'	552'	1106'
7200	134'10"	271'	545'	1090'

23-4 The Rhombic Antenna

The terminated *rhombic* or *diamond* is probably the most effective directional antenna that is practical for amateur communication. This antenna is non-resonant, with the result that it can be used on three amateur bands, such as 10, 20, and 40 meters. When the antenna is non-resonant, i.e., properly terminated, the system is unidirectional, and the wire dimensions are not critical.

Rhombic Termination When the free end is terminated with a resistance of a value between 700 and 800 ohms the backwave is eliminated, the forward gain is increased, and the antenna can be used on several bands without changes. The terminating resistance should be capable of dissipating one-third the power output of the transmitter, and should have very little reactance. For medium or low power transmitters, the non-inductive *plaque* resistors will serve as a satisfactory termination. Several manufacturers offer special resistors suitable for terminating a rhombic antenna. The terminating device should, for technical reasons, present a small amount of inductive reactance at the point of termination.

A compromise terminating device commonly used consists of a terminated 250-foot or longer length of line, made of resistance wire which does not have too much resistance per unit length. If the latter qualification is not met, the reactance of the line will be excessive. A 250-foot line consisting of no. 25 nichrome wire, spaced 6 inches and terminated with 800 ohms, will serve satisfactorily. Because of the attenuation of the line, the lumped resistance at the end of the line need dissipate but a few watts even when high power is used. A half-dozen 5000-ohm 2-watt carbon resistors in parallel will serve for all except very high power. The attenuating line may be folded back on itself to take up less room.

The determination of the best value of terminating resistor may be made while receiving, if the input impedance of the receiver is approximately 800 ohms. The value of resistor which gives the best directivity on reception will not give the most gain when transmitting, but there will be little difference between the two conditions.

The input resistance of the rhombic which is reflected into the transmission line that feeds it is always somewhat less than the terminating resistance, and is around 700 to 750 ohms when the terminating resistor is 800 ohms.

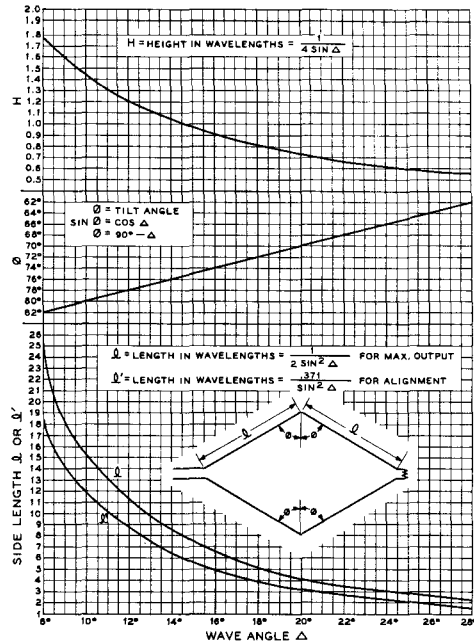

Figure 7
RHOMBIC ANTENNA DESIGN TABLE

Design data is given in terms of the wave angle (vertical angle of transmission and reception) of the antenna. The lengths l are for the "maximum output" design; the shorter lengths l' are for the "alignment" method which gives approximately 1.5 db less gain with a considerable reduction in the space required for the antenna. The values of side length, tilt angle, and height for a given wave angle are obtained by drawing a vertical line upward from the desired wave angle.

The antenna should be fed with a non-resonant line having a characteristic impedance of 650 to 700 ohms. The four corners of the rhombic should be at least one-half wavelength above ground for the lowest frequency of operation. For three-band operation the proper tilt angle ϕ for the center band should be observed.

The rhombic antenna transmits a horizontally-polarized wave at a relatively low angle above the horizon. The angle of radiation (wave angle) decreases as the height above ground is increased in the same manner as with a dipole antenna. The rhombic should not be tilted in any plane. In other words, the poles should all be of the same height and the plane of the antenna should be parallel with the ground.

Figure 8
TYPICAL RHOMBIC
ANTENNA DESIGN

The antenna system illustrated above may be used over the frequency range from 7 to 29 Mc. without change. The directivity of the system may be reversed by the system discussed in the text.

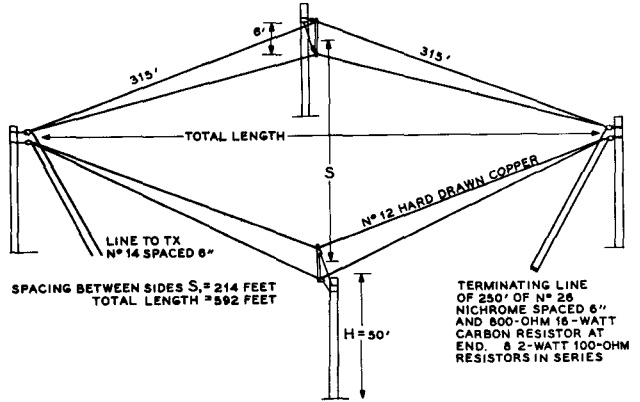

A considerable amount of directivity is lost when the terminating resistor is left off the end and the system is operated as a resonant antenna. If it is desired to reverse the direction of the antenna it is much better practice to run transmission lines to both ends of the antenna, and then run the terminating line to the operating position. Then with the aid of two d-p-d-t switches it will be possible to connect either feeder to the antenna changeover switch and the other feeder to the terminating line, thus reversing the direction of the array and maintaining the same termination for either direction of operation.

Figure 7 gives curves for optimum-design rhombic antennas by both the maximum-output method and the alignment method. The alignment method is about 1.5 db down from the maximum output method but requires only about 0.74 as much leg length. The height and tilt angle is the same in either case. Figure 8 gives construction data for a recommended rhombic antenna for the 7.0 through 29.7 Mc.

bands. This antenna will give about 11 db gain in the 14.0-Mc. band. The approximate gain of a rhombic antenna over a dipole, both above normal soil, is given in figure 9.

23-5 Stacked-Dipole Arrays

The characteristics of a half-wave dipole already have been described. When another dipole is placed in the vicinity and excited either directly or parasitically, the resultant radiation pattern will depend upon the spacing and phase differential, as well as the relative magnitude of the currents. With spacings less than 0.65 wavelength, the radiation is mainly broadside to the two wires (bidirectional) when there is no phase difference, and *through* the wires (end fire) when the wires are 180° out of phase. With phase differences between 0°

Figure 9
RHOMBIC ANTENNA GAIN

Showing the theoretical gain of a rhombic antenna, in terms of the side length, over a half-wave antenna mounted at the same height above the same type of soil.

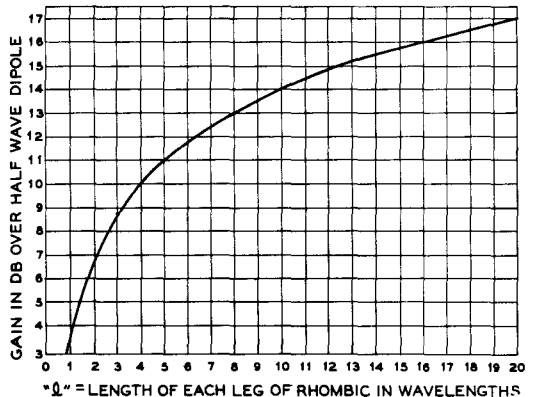

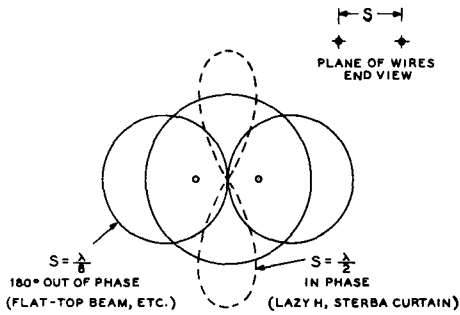

Figure 10

RADIATION PATTERNS OF A PAIR OF DIPOLES OPERATING WITH IN-PHASE EXCITATION, AND WITH EXCITATION 180° OUT OF PHASE

If the dipoles are oriented horizontally most of the directivity will be in the vertical plane; if they are oriented vertically most of the directivity will be in the horizontal plane.

and 180° (45°, 90°, and 135° for instance), the pattern is unsymmetrical, the radiation being greater in one direction than in the opposite direction.

With spacings of more than 0.8 wavelength, more than two main lobes appear for all phasing combinations; hence, such spacings are seldom used.

In-Phase Spacing With the dipoles driven so as to be in phase, the most effective spacing is between 0.5 and 0.7 wavelength. The latter provides greater gain, but minor lobes are present which do not appear at 0.5-wavelength spacing. The radiation is broadside to the plane of the wires, and the gain is slightly greater than can be obtained from two dipoles out of phase. The gain falls off rapidly for spacings less than 0.375 wavelength, and there is little point in using spacing of 0.25 wavelength or less with in-phase dipoles, except where it is desirable to increase the radiation resistance. (See *Multi-Wire Doublet*.)

Out of Phase Spacing When the dipoles are fed 180° out of phase, the directivity is through the plane of the wires, and is greatest with close spacing, though there is but little difference in the pattern after the spacing is made less than 0.125 wavelength. The radiation resistance becomes so low for spacings of less than 0.1 wavelength that such spacings are not practicable.

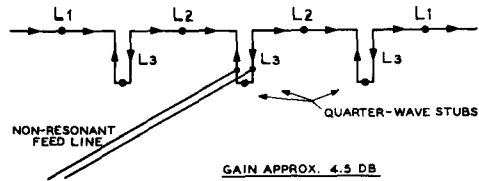

Figure 11

THE FRANKLIN OR COLINEAR ANTENNA ARRAY

An antenna of this type, regardless of the number of elements, attains all of its directivity through sharpening of the horizontal or azimuth radiation pattern; no vertical directivity is provided. Hence a long antenna of this type has an extremely sharp azimuth pattern, but no vertical directivity.

In the three foregoing examples, most of the directivity provided is in a plane at a right angle to the wires, though when out of phase, the directivity is in a line through the wires, and when in phase, the directivity is broadside to them. Thus, if the wires are oriented vertically, mostly horizontal directivity will be provided. If the wires are oriented horizontally, most of the directivity obtained will be vertical directivity.

To increase the sharpness of the directivity in all planes that include one of the wires, additional identical elements are added in the line of the wires, and fed so as to be in phase. The familiar H array is one array utilizing both types of directivity in the manner prescribed. The two-section Kraus flat-top beam is another.

These two antennas in their various forms are directional in a horizontal plane, in addition to being low-angle radiators, and are perhaps the most practicable of the bidirectional stacked-dipole arrays for amateur use. More phased elements can be used to provide greater directivity in planes including one of the radiating elements. The H then becomes a Sterba-curtain array.

For unidirectional work the most practicable stacked-dipole arrays for amateur-band use are parasitically-excited systems using relatively close spacing between the reflectors and the directors. Antennas of this type are described in detail in a later chapter. The next most practicable unidirectional array is an H or a Sterba curtain with a similar system placed approximately one-quarter wave behind. The use of a reflector system in conjunction with any type of stacked-dipole broadside array will increase the gain by 3 db.

COLINEAR ANTENNA DESIGN CHART			
FREQUENCY IN MC.	L1	L2	L3
28.5	16'8"	17'	8'6"
21.2	22'8"	23'3"	11'6"
14.2	33'8"	34'7"	17'3"
7.15	67'	68'8"	34'4"
4.0	120'	123'	61'6"
3.6	133'	136'5"	68'2"

Colinear Arrays The simple colinear antenna array is a very effective radiating system for the 3.5-Mc. and 7.0-Mc. bands, but its use is not recommended on higher frequencies since such arrays do not possess any vertical directivity. The elevation radiation pattern for such an array is essentially the same as for a half-wave dipole. This consideration applies whether the elements are of normal length or are extended.

The colinear antenna consists of two or more radiating sections from 0.5 to 0.65 wavelengths long, with the current in phase in each section. The necessary phase reversal between sections is obtained through the use of resonant tuning stubs as illustrated in figure 11. The gain of a colinear array using half-wave elements (in decibels) is approximately equal to the number of elements in the array. The exact figures are as follows:

Number of Elements	2	3	4	5	6
Gain in Decibels	1.8	3.3	4.5	5.3	6.2

As additional in-phase colinear elements are added to a doublet, the radiation resistance goes up much faster than when additional half waves are added out of phase (harmonic operated antenna).

For a colinear array of from 2 to 6 elements,

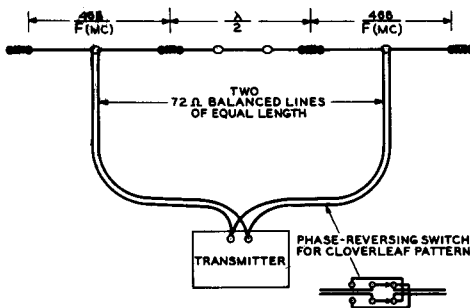

Figure 13

TWO COLINEAR HALF-WAVE ANTENNAS IN PHASE PRODUCE A 3 DB GAIN WHEN SEPARATED ONE-HALF WAVELENGTH

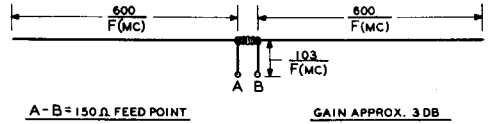

Figure 12

DOUBLE EXTENDED ZEPPE ANTENNA

For best results, antenna should be tuned to operating frequency by means of grid-dip oscillator.

the terminal radiation resistance in ohms at any current loop is approximately 100 times the number of elements.

It should be borne in mind that the gain from a colinear antenna depends upon the sharpness of the horizontal directivity since no vertical directivity is provided. An array with several colinear elements will give considerable gain, but will have a sharp horizontal radiation pattern.

Double Extended Zepp

The gain of a conventional two-element Franklin colinear antenna can be increased to a value approaching that obtained from a three-element Franklin, simply by making the two radiating elements 230° long instead of 180° long. The phasing stub is shortened correspondingly to maintain the whole array in resonance. Thus, instead of having 0.5-wavelength elements and 0.25-wavelength stub, the elements are made 0.64 wavelength long and the stub is approximately 0.11 wavelength long.

Dimensions for the double extended Zepp are given in figure 12.

The vertical directivity of a colinear antenna having 230° elements is the same as for one having 180° elements. There is little advantage in using extended sections when the total length of the array is to be greater than about 1.5 wavelength overall since the gain

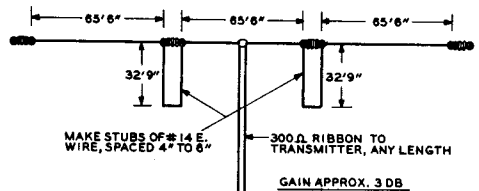

Figure 14

PRE-CUT LINEAR ARRAY FOR 40-METER OPERATION

of a colinear antenna is proportional to the overall length, whether the individual radiating elements are $\frac{1}{4}$ wave, $\frac{1}{2}$ wave or $\frac{3}{4}$ wave in length.

Spaced Half Wave Antennas The gain of two colinear half waves may be increased by increasing the physical spacing between the elements, up to a maximum of about one half wavelength. If the half wave elements are fed with equal lengths of transmission line, poled correctly, a gain of about 3.3 db is produced. Such an antenna is shown in figure 13. By means of a phase reversing switch, the two elements may be operated out of phase, producing a cloverleaf pattern with slightly less maximum gain.

A three element "precut" array for 40 meter operation is shown in figure 14. It is fed directly with 300 ohm "ribbon line," and may be matched to a 52 ohm coaxial output transmitter by means of a Balun, such as the Barker & Williamson 3975. The antenna has a gain of about 3.2 db, and a beam width at half-power points of 40 degrees.

23-6 Broadside Arrays

Colinear elements may be stacked above or below another string of colinear elements to produce what is commonly called a *broadside* array. Such an array, when horizontal elements are used, possesses vertical directivity in proportion to the number of broadsided (vertically stacked) sections which have been used. Since broadside arrays do have good vertical directivity their use is recommended on the 14-Mc. band and on those higher in frequency. One of the most popular of simple broadside arrays is the "Lazy H" array of figure 15. Horizontal colinear elements stacked two above two make up this antenna system which is highly recommended for work on frequencies above perhaps 14-Mc. when moderate gain without too much directivity is desired. It has high radiation resistance and a gain of approximately 5.5 db. The high radiation resistance results in low voltages and a broad resonance curve, which permits use of inexpensive insulators and enables the array to be used over a fairly wide range in frequency. For dimensions, see the stacked dipole design table.

Stacked Dipoles Vertical stacking may be applied to strings of colinear elements longer than two half waves. In such arrays, the end quarter wave of each string of radiators usually is bent in to meet

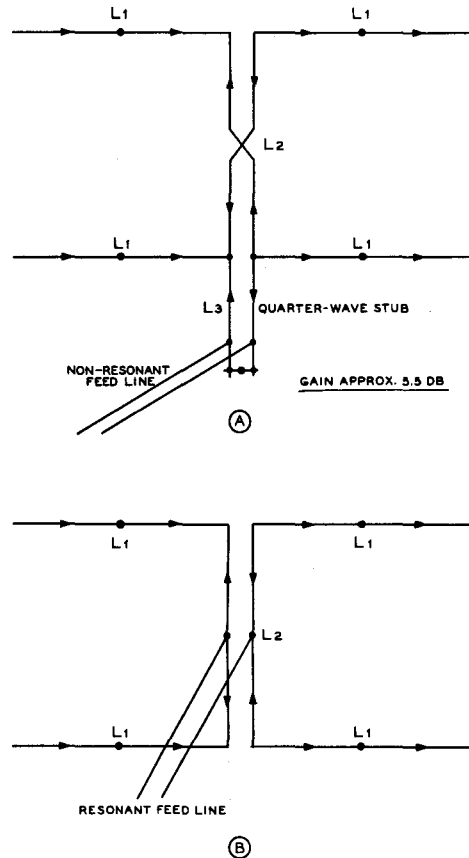

Figure 15

THE "LAZY H" ANTENNA SYSTEM

Stacking the colinear pairs gives both horizontal and vertical directivity. As shown, the array will give about 5.5 db gain. Note that the array may be fed either at the center of the phasing section or at the bottom; if fed at the bottom the phasing section must be twisted through 180° .

a similar bent quarter wave from the opposite end radiator. This provides better balance and better coupling between the upper and lower elements when the array is current-fed. Arrays of this type are shown in figure 16, and are commonly known as *curtain arrays*.

Correct length for the elements and stubs can be determined for any stacked dipole array from the *Stacked-Dipole Design Table*.

In the sketches of figure 16 the arrowheads represent the direction of current flow at any given instant. The dots on the radiators repre-

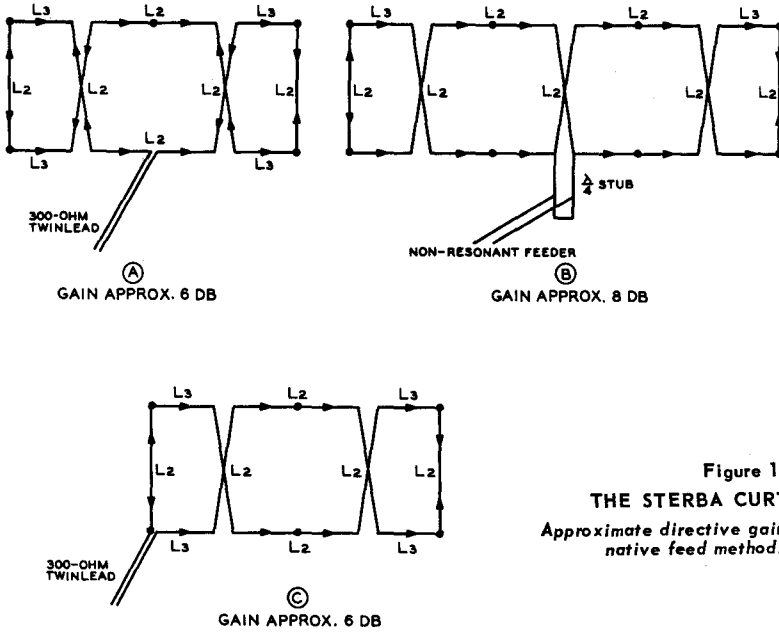

Figure 16
THE STERBA CURTAIN ARRAY
 Approximate directive gains along with alternative feed methods are shown.

sent points of maximum current. All arrows should point in the same direction in each portion of the radiating sections of an antenna in order to provide a field in phase for broadside radiation. This condition is satisfied for the arrays illustrated in figure 16. Figures 16A and 16C show simple methods of feeding a short Sterba curtain, while an alternative method of feed is shown in the higher gain antenna of figure 16B.

In the case of each of the arrays of figure 16, and also the "Lazy H" of figure 15, the array may be made unidirectional and the gain increased by 3 db if an exactly similar array is constructed and placed approximately $\frac{1}{4}$ wave behind the driven array. A screen or mesh of wires slightly greater in area than the antenna array may be used instead of an additional array as a reflector to obtain a unidirectional system. The spacing between the reflecting wires may vary from 0.05 to 0.1 wavelength with the spacing between the reflecting wires the smallest directly behind the driven elements. The wires in the untuned reflecting system should be parallel to the radiating elements of the array, and the spacing of the complete reflector system should be approximately 0.2 to 0.25 wavelength behind the driven elements.

On frequencies below perhaps 100 Mc. it normally will be impracticable to use a wire-screen reflector behind an antenna array such

as a Sterba curtain or a "Lazy H." Parasitic elements may be used as reflectors or directors, but parasitic elements have the disadvantage that their operation is selective with respect to relatively small changes in frequency. Nevertheless, parasitic reflectors for such arrays are quite widely used.

The X-Array In section 23-5 it was shown how two dipoles may be arranged in phase to provide a power gain of (some) 3 db. If two such pairs of dipoles are stacked

**LAZY-H AND STERBA
 (STACKED DIPOLE) DESIGN TABLE**

FREQUENCY IN MC.	L ₁	L ₂	L ₃
7.0	68'2"	70"	35"
7.3	65'10"	67'6"	33'9"
14.0	34'1"	35"	17'6"
14.2	33'8"	34'7"	17'3"
14.4	33'4"	34'2"	17"
21.0	22'9"	23'3"	11'8"
21.5	22'3"	22'9"	11'5"
27.3	17'7"	17'10"	8'11"
28.0	17"	17'7"	8'9"
29.0	16'6"	17"	8'6"
50.0	9'7"	9'10"	4'11"
52.0	9'3"	9'5"	4'8"
54.0	8'10"	9'1"	4'6"
144.0	39.8"	40.5"	20.3"
146.0	39"	40"	20"
148.0	38.4"	39.5"	19.8"

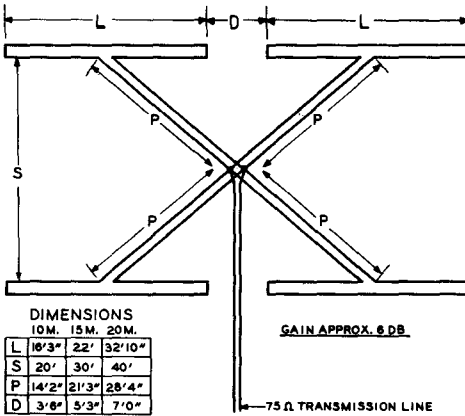

Figure 17
THE X-ARRAY FOR 28 MC., 21 MC.,
OR 14 MC.

The entire array (with the exception of the 75-ohm feed line) is constructed of 300-ohm ribbon line. Be sure phasing lines (P) are poled correctly, as shown.

in a vertical plane and properly phased, a simplified form of in-phase curtain is formed, providing an overall gain of about 6 db. Such an array is shown in figure 17. In this X-array, the four dipoles are all in phase, and are fed by four sections of 300-ohm line, each one-half wavelength long, the free ends of all four lines being connected in parallel. The feed impedance at the junction of these four lines is about 75 ohms, and a length of 75-ohm Twin-Lead may be used for the feedline to the array.

An array of this type is quite small for the 28-Mc. band, and is not out of the question for the 21-Mc. band. For best results, the bottom section of the array should be one-half wavelength above ground.

The Double-Bruce Array The Bruce Beam consists of a long wire folded so that vertical elements carry in-phase currents while the horizontal elements carry out of phase currents. Radiation from the horizontal sections is low since only a small current flows in this part of the wire, and it is largely phased-out. Since the height of the Bruce Beam is only one-quarter wavelength, the gain per linear foot of array is quite low. Two Bruce Beams may be combined as shown in figure 18 to produce the *Double Bruce* array. A four section Double Bruce will give a vertically polarized emission, with a power gain of 5 db over a simple

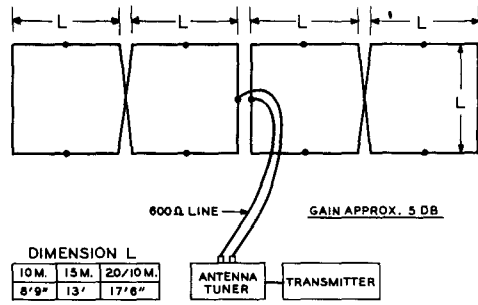

Figure 18
THE DOUBLE-BRUCE ARRAY FOR 10,
15, AND 20 METERS

If a 600-ohm feed line is used, the 20-meter array will also perform on 10 meters as a Sterba curtain, with an approximate gain of 9 db.

dipole, and is a very simple beam to construct. This antenna, like other so-called "broadside" arrays, radiates maximum power at right angles to the plane of the array.

The feed impedance of the Double Bruce is about 750 ohms. The array may be fed with a one-quarter wave stub made of 300-ohm ribbon line and a feedline made of 150-ohm ribbon line. Alternatively, the array may be fed directly with a wide-spaced 600-ohm transmission line (figure 18). The feedline should be brought away from the Double Bruce for a short distance before it drops downward, to prevent interaction between the feedline and the lower part of the center phasing section of the array. For best results, the bottom sections of the array should be one-half wavelength above ground.

Arrays such as the X-array and the Double Bruce are essentially high impedance devices, and exhibit relatively broad-band characteristics. They are less critical of adjustment than a parasitic array, and they work well over a wide frequency range such as is encountered on the 28-29.7 Mc. band.

The "Bi-Square" Broadside Array Illustrated in figure 19 is a simple method of feeding a small broadside array first described by W6BCX several years ago as a practical method of suspending an effective array from a single pole. As two arrays of this type can be supported at right angles from a single pole without interaction, it offers a solution to the problem of suspending two arrays in a restricted space with a minimum of erection work. The free space directivity gain is slightly less than that of a Lazy H, but is

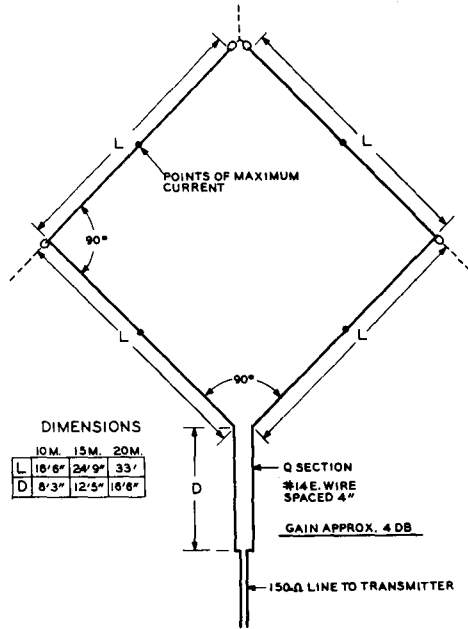

Figure 19

THE "BI-SQUARE" BROADSIDE ARRAY

This bidirectional array is related to the "Lazy H," and in spite of the oblique elements, is horizontally polarized. It has slightly less gain and directivity than the Lazy H, the free space directivity gain being approximately 4 db. Its chief advantage is the fact that only a single pole is required for support, and two such arrays may be supported from a single pole without interaction if the planes of the elements are at right angles. A 600-ohm line may be substituted for the Twin-Lead, and either operated as a resonant line, or made non-resonant by the incorporation of a matching stub.

still worthwhile, being approximately 4 db over a half-wave horizontal dipole at the same average elevation.

When two Bi-Square arrays are suspended at right angles to each other (for general coverage) from a single pole, the Q sections should be well separated or else symmetrically arranged in the form of a square (the diagonal conductors forming one Q section) in order to minimize coupling between them. The same applies to the line if open construction is used instead of Twin-Lead, but if Twin-Lead is used the coupling can be made negligible simply by separating the two Twin-Lead lines by at least two inches and twisting one Twin-Lead so as to effect a transposition every foot or so.

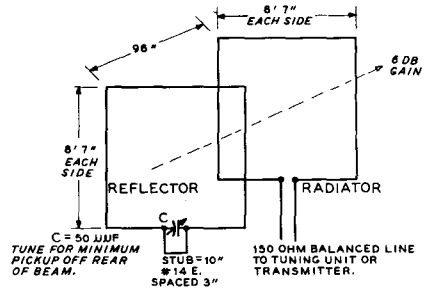

NOTE: SIDE LENGTH = 11' 8" FOR 21 MC.
17' 7" FOR 14 MC.
ELEMENT SPACING 96" FOR EACH BAND.
STUB LENGTH APPROX. 15" FOR 21 MC.
20" FOR 14 MC.

Figure 20
THE CUBICAL-QUAD ANTENNA FOR THE 10-METER BAND

When tuned feeders are employed, the Bi-Square array can be used on half frequency as an end-fire vertically polarized array, giving a slight practical dx signal gain over a vertical half-wave dipole at the same height.

A second Bi-Square serving as a reflector may be placed 0.15 wavelength behind this antenna to provide an overall gain of 8.5 db. The reflector may be tuned by means of a quarter-wave stub which has a moveable shorting bar at the bottom end. The stub is used as a substitute for the Q-section, since the reflector employs no feed line.

The "Cubical-Quad" Antenna A smaller version of the Bi-Square antenna is the Cubical-Quad antenna. Two half-waves of wire are folded into a square that is one-quarter wavelength on a side, as shown in figure 20. The array radiates a horizontally polarized signal. A reflector placed 0.15 wavelength behind the antenna provides an overall gain of some 6 db. A shorted stub with a parallel tuning capacitor is used to resonate the reflector.

The Cubical-Quad is fed with a 150-ohm line, and should employ some sort of antenna tuner at the transmitter end of the line if a pi-network type transmitter is used. There is a small standing wave on the line, and an open

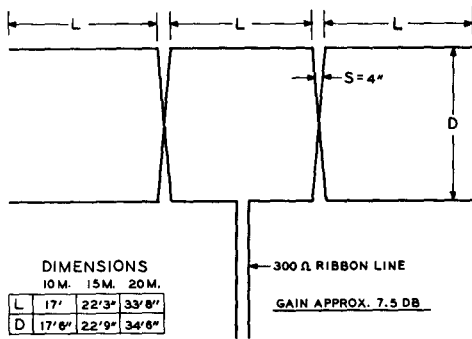

Figure 21

THE "SIX-SHOOTER" BROADSIDE ARRAY

wire line should be employed if the antenna is used with a high power transmitter.

To tune the reflector, the back of the antenna is aimed at a nearby field-strength meter and the reflector stub capacitor is adjusted for minimum received signal at the operating frequency.

This antenna provides high gain for its small size, and is recommended for 28-Mc. work. The elements may be made of number 14 enamel wire, and the array may be built on a light bamboo or wood framework.

The "Six-Shooter" Broadside Array As a good compromise between gain, directivity, compactness, mechanical simplicity, ease of adjustment, and band width the array of figure 21 is recommended for the 10 to 30 Mc. range when the additional array width and greater directivity are not obtainable. The free space directivity gain is approximately 7.5 db over one element, and the practical dx signal gain over one element at the same average elevation is of about the same magnitude when the array is sufficiently elevated. To show up to best advantage the array should be elevated sufficiently to put the lower elements well in the clear, and preferably at least 0.5 wavelength above ground.

The "Bobtail" Bidirectional Broadside Curtain Another application of vertical orientation of the radiating elements of an array in order to obtain low-angle radiation at the lower end of the h-range with low pole heights is illustrated in figure 22. When precut to the specified dimensions this single pattern array will perform well over the 7-Mc. amateur band or the 4-Mc. amateur phone band. For the 4-Mc. band the required two poles need be only 70 feet high, and the array will provide a practical signal

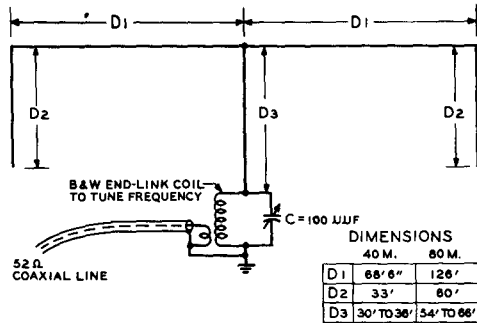

Figure 22

"BOBTAIL" BIDIRECTIONAL BROADSIDE CURTAIN FOR THE 7-MC. OR THE 4.0-MC. AMATEUR BANDS

This simple vertically polarized array provides low angle radiation and response with comparatively low pole heights, and is very effective for dx work on the 7-Mc. band or the 4.0-Mc. phone band. Because of the phase relationships, radiation from the horizontal portion of the antenna is effectively suppressed. Very little current flows in the ground lead to the coupling tank; so an elaborate ground system is not required, and the length of the ground lead is not critical so long as it uses heavy wire and is reasonably short.

gain averaging from 7 to 10 db over a horizontal half-wave dipole utilizing the same pole height when the path length exceeds 2500 miles.

The horizontal directivity is only moderate, the beam width at the half power points being slightly greater than that obtained from three cophased vertical radiators fed with equal currents. This is explained by the fact that the current in each of the two outer radiators of this array carries only about half as much current as the center, driven element. While this "binomial" current distribution suppresses the end-fire lobe that occurs when an odd number of parallel radiators with half-wave spacing are fed equal currents, the array still exhibits some high-angle radiation and response off the ends as a result of imperfect cancellation in the flat top portion. This is not sufficient to affect the power gain appreciably, but does degrade the discrimination somewhat.

A moderate amount of sag can be tolerated at the center of the flat top, where it connects to the driven vertical element. The poles and antenna tank should be so located with respect to each other that the driven vertical element drops approximately straight down from the flat top.

Normally the antenna tank will be located in the same room as the transmitter, to facilitate adjustment when changing frequency. In this case it is recommended that the link coupled tank be located across the room from the transmitter if much power is used, in order to minimize r-f feedback difficulties which might occur as a result of the asymmetrical high impedance feed. If tuning of the antenna tank from the transmitter position is desired, flexible shafting can be run from the antenna tank condenser to a control knob at the transmitter.

The lower end of the driven element is quite "hot" if much power is used, and the lead-in insulator should be chosen with this in mind. The ground connection need not have very low resistance, as the current flowing in the ground connection is comparatively small. A stake or pipe driven a few feet in the ground will suffice. However, the ground lead should be of heavy wire and preferably the length should not exceed about 10 feet at 7 Mc. or about 20 feet at 4 Mc. in order to minimize reactive effects due to its inductance. If it is impossible to obtain this short a ground lead, a piece of screen or metal sheet about four feet square may be placed parallel to the earth in a convenient location and used as an artificial ground. A fairly high C/L ratio ordinarily will be required in the antenna tank in order to obtain adequate coupling and loading.

23-7 End-Fire Directivity

By spacing two half-wave dipoles, or colinear arrays, at a distance of from 0.1 to 0.25 wavelength and driving the two 180° out of phase, directivity is obtained *through the two wires* at right angles to them. Hence, this type of bidirectional array is called *end fire*. A better idea of end-fire directivity can be obtained by referring to figure 10.

Remember that *end-fire* refers to the radiation with respect to the two wires in the array rather than with respect to the array as a whole.

The vertical directivity of an end-fire bidirectional array which is oriented horizontally can be increased by placing a similar end-fire array a half wave below it, and excited in the same phase. Such an array is a combination broadside and end-fire affair.

Kraus Flat-Top Beam A very effective bidirectional end-fire array is the Kraus or 8JK *Flat-Top Beam*. Essentially, this antenna consists of two close-spaced dipoles or colinear arrays. Because of the close spacing, it is possible to obtain the

proper phase relationships in multi-section flat tops by crossing the wires at the voltage loops, rather than by resorting to phasing stubs. This greatly simplifies the array. (See figure 23.) Any number of sections may be used, though the one- and two-section arrangements are the most popular. Little extra gain is obtained by using more than four sections, and trouble from phase shift may appear.

A center-fed single-section flat-top beam cut according to the table, can be used quite successfully on its second harmonic, the pattern being similar except that it is a little sharper. The single-section array can also be used on its fourth harmonic with some success, though there then will be four cloverleaf lobes, much the same as with a full-wave antenna.

If a flat-top beam is to be used on more than one band, tuned feeders are necessary.

The radiation resistance of a flat-top beam is rather low, especially when only one section is used. This means that the voltage will be high at the voltage loops. For this reason, especially good insulators should be used for best results in wet weather.

The exact lengths for the radiating elements are not especially critical, because slight deviations from the correct lengths can be compensated in the stub or tuned feeders. Proper stub adjustment is covered in Chapter Twenty-five. Suitable radiator lengths and approximate stub dimensions are given in the accompanying design table.

Figure 23 shows *top views* of eight types of flat-top beam antennas. The dimensions for using these antennas on different bands are given in the design table. The 7- and 28-Mc. bands are divided into two parts, but the dimensions for either the low- or high-frequency ends of these bands will be satisfactory for use over the entire band.

In any case, the antennas are tuned to the frequency used, by adjusting the shorting wire on the stub, or tuning the feeders, if no stub is used. The data in the table may be extended to other bands or frequencies by applying the proper factor. Thus, for 50 to 52 Mc. operation, the values for 28 to 29 Mc. are divided by 1.8.

All of the antennas have a bidirectional horizontal pattern on their fundamental frequency. The maximum signal is broadside to the flat top. The single-section type has this pattern on both its fundamental frequency and second harmonic. The other types have four main lobes of radiation on the second and higher harmonics. The nominal gains of the different types over a half-wave comparison antenna are as follows: single-section, 4 db; two-section, 6 db; four-section, 8 db.

The maximum spacings given make the beams less critical in their adjustments. Up

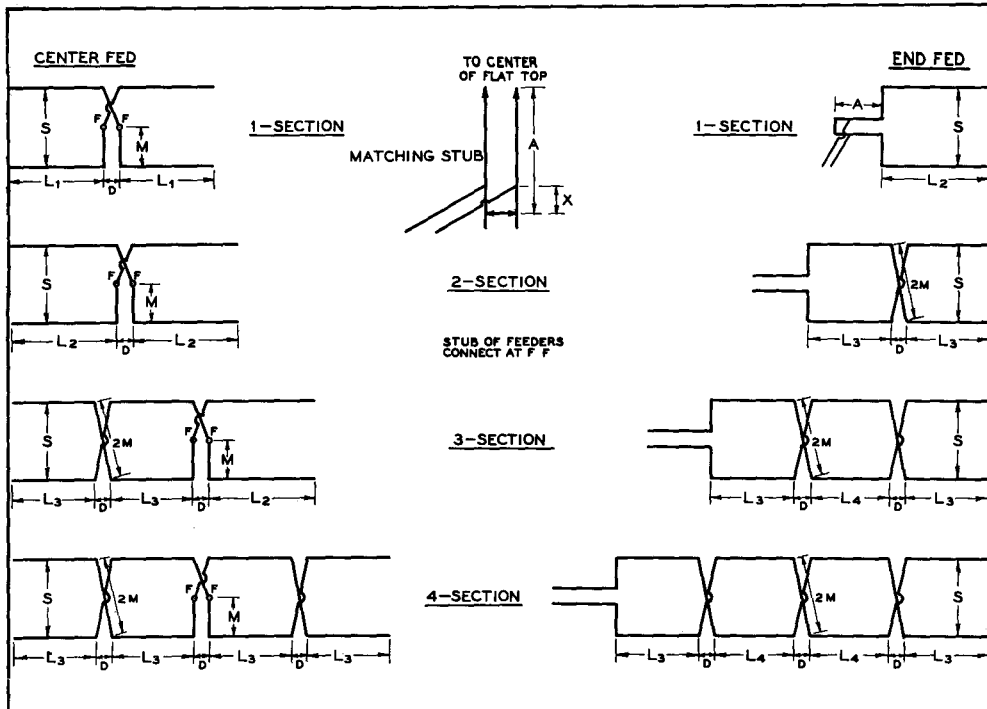

FIGURE 23

FLAT-TOP BEAM (8JK ARRAY) DESIGN DATA.

FREQUENCY	Spac- ing	S	L ₁	L ₂	L ₃	L ₄	M	D	A (¼) approx.	A (½) approx.	A (¾) approx.	X approx.
7.0-7.2 Mc.	$\lambda/8$	17'4"	34'	60'	52'8"	44'	8'10"	4'	26'	60'	96'	4'
7.2-7.3	$\lambda/8$	17'0"	33'6"	59'	51'8"	43'1"	8'8"	4'	26'	59'	94'	4'
14.0-14.4	$\lambda/8$	8'8"	17'	30'	26'4"	22'	4'5"	2'	13'	30'	48'	2'
14.0-14.4	.15 λ	10'5"	17'	30'	25'3"	20'	5'4"	2'	12'	29'	47'	2'
14.0-14.4	.20 λ	13'11"	17'	30'	22'10"	7'2"	2'	10'	27'	45'	3'
14.0-14.4	$\lambda/4$	17'4"	17'	30'	20'8"	8'10"	2'	8'	25'	43'	4'
28.0-29.0	.15 λ	5'2"	8'6"	15'	12'7"	10'	2'8"	1'6"	7'	15'	24'	1'
28.0-29.0	$\lambda/4$	8'8"	8'6"	15'	10'4"	4'5"	1'6"	5'	13'	22'	2'
29.0-30.0	.15 λ	5'0"	8'3"	14'6"	12'2"	9'8"	2'7"	1'6"	7'	15'	23'	1'
29.0-30.0	$\lambda/4$	8'4"	8'3"	14'6"	10'0"	4'4"	1'6"	5'	13'	21'	2'

Dimension chart for flat-top beam antennas. The meanings of the symbols are as follows:
 L₁, L₂, L₃ and L₄, the lengths of the sides of the flat-top sections as shown. L₁ is length of the sides of single-section center-fed, L₂ single-section end-fed and 2-section center-fed, L₃ 4-section center-fed and end-sections of 4-section end-fed, and L₄ middle sections of 4-section end-fed.
 S, the spacing between the flat-top wires.
 M, the wire length from the outside to the center of each cross-over.
 D, the spacing lengthwise between sections.
 A (¼), the approximate length for a quarter-wave stub.
 A (½), the approximate length for a half-wave stub.
 A (¾), the approximate length for a three-quarter wave stub.
 X, the approximate distance above the shorting wire of the stub for the connection of a 600-ohm line. This distance, as given in the table, is approximately correct only for 2-section flat-tops.
 For single-section types it will be smaller and for 3- and 4-section types it will be larger.
 The lengths given for a half-wave stub are applicable only to single-section center-fed flat-tops. To be certain of sufficient stub length, it is advisable to make the stub a foot or so longer than shown in the table, especially with the end-fed types. The lengths, A, are measured from the point where the stub connects to the flat-top.
 Both the center and end-fed types may be used horizontally. However, where a vertical antenna is desired, the flat-tops can be turned on end. In this case, the end-fed types may be more convenient, feeding from the lower end.

Figure 24
THE TRIPLEX FLAT-TOP BEAM
ANTENNA FOR 10, 15 AND 20
METERS

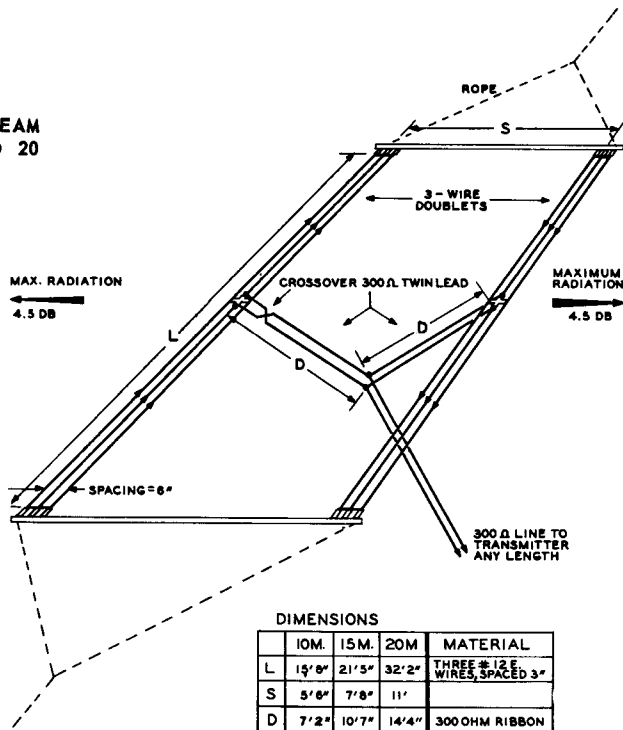

to one-quarter wave spacing may be used on the fundamental for the one-section types and also the two-section center-fed, but it is not desirable to use more than 0.15 wavelength spacing for the other types.

Although the center-fed type of flat-top generally is to be preferred because of its symmetry, the end-fed type often is convenient or desirable. For example, when a flat-top beam is used vertically, feeding from the lower end is in most cases more convenient.

If a multisection flat-top array is end-fed instead of center-fed, and tuned feeders are used, stations off the ends of the array can be worked by tying the feeders together and working the whole affair, feeders and all, as a long-wire harmonic antenna. A single-pole double-throw switch can be used for changing the feeders and directivity.

The Triplex Beam The Triplex beam is a modified version of the W8JK antenna which uses folded dipoles for the half wave elements of the array. The use of folded dipoles results in higher radiation resistance of the array, and a high overall system performance. Three wire dipoles are used for the elements, and 300-ohm Twin-Lead is

used for the two phasing sections. A recommended assembly for Triplex beams for 28 Mc., 21 Mc., and 14 Mc. is shown in figure 24. The gain of a Triplex beam is about 4.5 db over a dipole.

23-8 Combination End-Fire and Broadside Arrays

Any of the end-fire arrays previously described may be stacked one above the other or placed end to end (side by side) to give greater directivity gain while maintaining a bidirectional characteristic. However, it must be kept in mind that to realize a worthwhile increase in directivity and gain while maintaining a bidirectional pattern the individual arrays must be spaced sufficiently to reduce the mutual impedances to a negligible value.

When two flat top beams, for instance, are placed one above the other or end to end, a center spacing on the order of one wavelength is required in order to achieve a worthwhile increase in gain, or approximately 3 db.

Thus it is seen that, while maximum gain occurs with two stacked dipoles at a spacing of about 0.7 wavelength and the space directivity gain is approximately 5 db over one element under these conditions; the case of two flat top or parasitic arrays stacked one above the other is another story. Maximum gain will occur at a greater spacing, and the gain over one array will not appreciably exceed 3 db.

When two broadside curtains are placed one ahead of the other in end-fire relationship, the aggregate mutual impedance between the two curtains is such that considerable spacing is required in order to realize a gain approaching 3 db (the required spacing being a function of the size of the curtains). While it is true that a space directivity gain of approximately 4 db can be obtained by placing one, half-wave dipole an eighth wavelength ahead of another and feeding them 180 degrees out of phase, a gain of less than 1 db is obtained when the same procedure is applied to two large broadside curtains. To obtain a gain of approximately 3 db and retain a bidirectional pattern, a spacing of many wavelengths is required between two large curtains placed one ahead of the other.

A different situation exists, however, when one driven curtain is placed ahead of an identical one and the two are phased so as to give a unidirectional pattern. When a unidirectional pattern is obtained, the gain over one curtain will be approximately 3 db regardless of the spacing. For instance, two large curtains placed one a quarter wavelength ahead of the other may have a space directivity gain of only 0.5 db over one curtain when the two are driven 180 degrees out of phase to give a bidirectional pattern (the type of pattern obtained with a single curtain). However, if they are driven in phase quadrature (and with equal currents) the gain is approximately 3 db.

The directivity gain of a composite array also can be explained upon the basis of the directivity patterns of the component arrays alone, but it entails a rather complicated picture. It is sufficient for the purpose of this discussion to generalize and simplify by saying that the greater the directivity of an end-fire array, the farther an identical array must be spaced from it in broadside relationship to obtain optimum performance; and the greater the directivity of a broadside array, the farther

an identical array must be spaced from it in end-fire relationship to obtain optimum performance and retain the bidirectional characteristic.

It is important to note that while a bidirectional end-fire pattern is obtained with two driven dipoles when spaced anything under a half wavelength, and while the proper phase relationship is 180 degrees regardless of the spacing for all spacings not exceeding one half wavelength, the situation is different in the case of two curtains placed in end-fire relationship to give a bidirectional pattern. For maximum gain at zero wave angle, the curtains should be spaced an odd multiple of one half wavelength and driven so as to be 180 degrees out of phase, or spaced an even multiple of one half wavelength and driven in the same phase. The optimum spacing and phase relationship will depend upon the directivity pattern of the individual curtains used alone, and as previously noted the optimum spacing increases with the size and directivity of the component arrays.

A concrete example of a combination broadside and end-fire array is two Lazy H arrays spaced along the direction of maximum radiation by a distance of four wavelengths and fed in phase. The space directivity gain of such an arrangement is slightly less than 9 db. However, approximately the same gain can be obtained by juxtaposing the two arrays side by side or one over the other in the same plane, so that the two combine to produce, in effect, one broadside curtain of twice the area. It is obvious that in most cases it will be more expedient to increase the area of a broadside array than to resort to a combination of end-fire and broadside directivity. One exception, of course, is where two curtains are fed in phase quadrature to obtain a unidirectional pattern and space directivity gain of approximately 3 db with a spacing between curtains as small as one quarter wavelength. Another exception is where very low angle radiation is desired and the maximum pole height is strictly limited. The two aforementioned Lazy H arrays when placed in end-fire relationship will have a considerably lower radiation angle than when placed side by side if the array elevation is low, and therefore may *under some conditions* exhibit appreciably more practical signal gain.

V-H-F and U-H-F Antennas

The *very-high-frequency* or *v-h-f* frequency range is defined as that range falling between 30 and 300 Mc. The *ultra-high-frequency* or *u-h-f* range is defined as falling between 300 and 3000 Mc. This chapter will be devoted to the design and construction of antenna systems for operation on the amateur 50-Mc., 144-Mc., 235-Mc., and 420-Mc. bands. Although the basic principles of antenna operation are the same for all frequencies, the shorter physical length of a wave in this frequency range and the differing modes of signal propagation make it possible and expedient to use antenna systems different in design from those used on the range from 3 to 30 Mc.

24-1 Antenna Requirements

Any type of antenna system useable on the lower frequencies may be used in the v-h-f and u-h-f bands. In fact, simple non-directive half-wave or quarter-wave vertical antennas are very popular for general transmission and reception from all directions, especially for short-range work. But for serious v-h-f or u-h-f work the use of some sort of directional antenna array is a necessity. In the first place, when the transmitter power is concentrated into a narrow beam the apparent transmitter power at the receiving station is increased many times. A "billboard" array or a Sterba curtain having a gain of 16 db will make a 25-watt transmitter sound like a kilowatt at the other

station. Even a much simpler and smaller three- or four-element parasitic array having a gain of 7 to 10 db will produce a marked improvement in the received signal at the other station.

However, as all v-h-f and u-h-f workers know, the most important contribution of a high-gain antenna array is in reception. If a remote station cannot be heard it obviously is impossible to make contact. The limiting factor in v-h-f and u-h-f reception is in almost every case the noise generated within the receiver itself. Atmospheric noise is almost non-existent and ignition interference can almost invariably be reduced to a satisfactory level through the use of an effective noise limiter. Even with a grounded-grid or neutralized triode first stage in the receiver the noise contribution of the first tuned circuit in the receiver will be relatively large. Hence it is desirable to use an antenna system which will deliver the greatest signal voltage to the first tuned circuit for a given field strength at the receiving location.

Since the field intensity being produced at the receiving location by a remote transmitting station may be assumed to be constant, the receiving antenna which intercepts the greatest amount of wave front, assuming that the polarization and directivity of the receiving antenna is proper, will be the antenna which gives the best received signal-to-noise ratio. An antenna which has two square wavelengths effective area will pick up twice as much signal power as one which has one square wavelength area, assuming the same general type of antenna and

that both are directed at the station being received. Many instances have been reported where a frequency band sounded completely dead with a simple dipole receiving antenna but when the receiver was switched to a three-element or larger array a considerable amount of activity from 80 to 160 miles distant was heard.

Angle of Radiation The useful portion of the signal in the v-h-f and u-h-f range for short or medium distance communication is that which is radiated at a very low angle with respect to the surface of the earth; essentially it is that signal which is radiated parallel to the surface of the earth. A vertical antenna transmits a portion of its radiation at a very low angle and is effective for this reason; its radiation is not necessarily effective simply because it is vertically polarized. A simple horizontal dipole radiates very little low-angle energy and hence is not a satisfactory v-h-f or u-h-f radiator. Directive arrays which concentrate a major portion of the radiated signal at a low radiation angle will prove to be effective radiators whether their signal is horizontally or vertically polarized.

In all cases, the radiating system for v-h-f and u-h-f work should be as high and in the clear as possible. Increasing the height of the antenna system will produce a very marked improvement in the number and strength of the signals heard, regardless of the actual type of antenna used.

Transmission Lines Transmission lines to v-h-f and u-h-f antenna systems may be either of the parallel-conductor or coaxial conductor type. Coaxial line is recommended for short runs and closely spaced open-wire line for longer runs. Wave guides may be used under certain conditions for frequencies greater than perhaps 1500 Mc. but their dimensions become excessively great for frequencies much below this value. Non-resonant transmission lines will be found to be considerably more efficient on these frequencies than those of the resonant type. It is wise to use the very minimum length of transmission line possible since transmission line losses at frequencies above about 100 Mc. mount very rapidly.

Open lines should preferably be spaced closer than is common for longer wavelengths, as 6 inches is an appreciable fraction of a wavelength at 2 meters. Radiation from the line will be greatly reduced if 1-inch or 1½-inch spacing is used, rather than the more common 6-inch spacing.

Ordinary TV-type 300-ohm ribbon may be used on the 2-meter band for feeder lengths

of about 50 feet or less. For longer runs, either the u-h-f or v-h-f TV open-wire lines may be used with good overall efficiency. The v-h-f line is satisfactory for use on the amateur 420-Mc. band.

Antenna Changeover It is recommended that the same antenna be used for transmitting and receiving in the v-h-f and u-h-f range. An ever-present problem in this connection, however, is the antenna changeover relay. Reflections at the antenna changeover relay become of increasing importance as the frequency of transmission is increased. When coaxial cable is used as the antenna transmission line, satisfactory coaxial antenna changeover relays with low reflection can be used. One type manufactured by *Advance Electric & Relay Co.*, Los Angeles 26, Calif., will give a satisfactorily low value of reflection.

On the 235-Mc. and 420-Mc. amateur bands, the size of the antenna array becomes quite small, and it is practical to mount two identical antennas side by side. One of these antennas is used for the transmitter, and the other antenna for the receiver. Separate transmission lines are used, and the antenna relay may be eliminated.

Effect of Feed System on Radiation Angle A vertical radiator for general coverage u-h-f use should be made either ¼ or ½ wavelength long. Longer vertical antennas do not have their maximum radiation at right angles to the line of the radiator (unless co-phased), and, therefore, are not practicable for use where greatest possible radiation parallel to the earth is desired.

Unfortunately, a feed system which is not perfectly balanced and does some radiating, not only robs the antenna itself of that much power, but *distorts the radiation pattern of the antenna*. As a result, the pattern of a vertical radiator may be so altered that the radiation is bent upwards slightly, and the amount of power leaving the antenna parallel to the earth is greatly reduced. A vertical half-wave radiator fed at the bottom by a quarter-wave stub is a good example of this; the slight radiation from the matching section decreases the power radiated parallel to the earth by nearly 10 db.

The only cure is a feed system which does not disturb the radiation pattern of the antenna itself. This means that if a 2-wire line is used, the current and voltages must be exactly the same (though 180° out of phase) at any point on the feed line. It means that if a concentric feed line is used, there should be no current flowing on the outside of the outer conductor.

Radiator Cross Section There is no point in using copper tubing for an antenna on the medium frequencies.

The reason is that considerable tubing would be required, and the cross section still would not be a sufficiently large fraction of a wavelength to improve the antenna bandwidth characteristics. At very high and ultra high frequencies, however, the radiator length is so short that the expense of large diameter conductor is relatively small, even though copper pipe of 1 inch cross section is used. With such conductors, the antenna will tune much more broadly, and often a broad resonance characteristic is desirable. This is particularly true when an antenna or array is to be used over an entire amateur band.

It should be kept in mind that with such large cross section radiators, the resonant length of the radiator will be somewhat shorter, being only slightly greater than 0.90 of a half wavelength for a dipole when heavy copper pipe is used above 100 Mc.

Insulation The matter of insulation is of prime importance at very high frequencies. Many insulators that have very low losses as high as 30 Mc. show up rather poorly at frequencies above 100 Mc. Even the low loss ceramics are none too good where the r-f voltage is high. One of the best and most practical insulators for use at this frequency is polystyrene. It has one disadvantage, however, in that it is subject to fracture and to deformation in the presence of heat.

It is common practice to design v-h-f and u-h-f antenna systems so that the various radiators are supported only at points of relatively low voltage; the best insulation, obviously, is air. The voltages on properly operated untuned feed lines are not high, and the question of insulation is not quite so important, though insulation still should be of good grade.

Antenna Polarization Commercial broadcasting in the U.S.A. for both FM and television in the v-h-f range has been standardized on horizontal polarization. One of the main reasons for this standardization is the fact that ignition interference is reduced through the use of a horizontally polarized receiving antenna. Amateur practice, however, is divided between horizontal and vertical polarization in the v-h-f and u-h-f range. Mobile stations are invariably vertically polarized due to the physical limitations imposed by the automobile antenna installation. Most of the stations doing intermittent or occasional work on these frequencies use a simple ground-plane vertical antenna for both transmission and reception. However, those

Frequency in Mc.	1/4 Wave Free Space	1/4 Wave Antenna	1/2 Wave Free Space	1/2 Wave Antenna
50.0	59.1	55.5	118.1	111.0
50.5	58.5	55.0	116.9	109.9
51.0	57.9	54.4	115.9	108.8
51.5	57.4	53.9	114.7	107.8
52.0	56.8	53.4	113.5	106.7
52.5	56.3	52.8	112.5	105.7
53.0	55.7	52.4	111.5	104.7
54.0	54.7	51.4	109.5	102.8
144	20.5	19.2	41.0	38.5
145	20.4	19.1	40.8	38.3
146	20.2	18.9	40.4	38.0
147	20.0	18.8	40.0	37.6
148	19.9	18.6	39.9	37.2
235	12.6	11.8	25.2	23.6
236	12.5	11.8	25.1	23.5
237	12.5	11.7	25.0	23.5
238	12.4	11.7	24.9	23.4
239	12.4	11.6	24.8	23.3
240	12.3	11.6	24.6	23.2
420	7.05	6.63	14.1	13.25
425	6.95	6.55	13.9	13.1
430	6.88	6.48	13.8	12.95

All dimensions are in inches. Lengths have in most cases been rounded off to three significant figures. "1/2-Wave Free-Space" column shown above should be used with Lecher wires for frequency measurement.

stations doing serious work and striving for maximum-range contacts on the 50-Mc. and 144-Mc. bands almost invariably use horizontal polarization.

Experience has shown that there is a great attenuation in signal strength when using crossed polarization (transmitting antenna with one polarization and receiving antenna with the other) for all normal ground-wave contacts on these bands. When contacts are being made through sporadic-E reflection, however, the use of crossed polarization seems to make no discernible difference in signal strength. So the operator of a station doing v-h-f work (particularly on the 50-Mc. band) is faced with a problem: If contacts are to be made with all stations doing work on the same band, provision must be made for operation on both horizontal and vertical polarization. This problem has been solved in many cases through the construction of an antenna array that may be revolved in the plane of polarization in addition to being capable of rotation in the azimuth plane.

An alternate solution to the problem which involves less mechanical construction is simply to install a good ground-plane vertical antenna for all vertically-polarized work, and then to use a multi-element horizontally-polarized array for dx work.

24-2 Simple Horizontally-Polarized Antennas

Antenna systems which do not concentrate

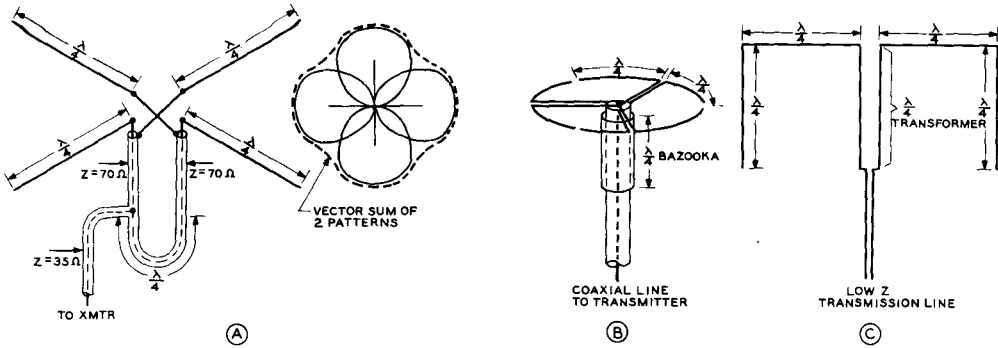

Figure 1
THREE NONDIRECTIONAL, HORIZONTALLY POLARIZED ANTENNAS

radiation at the very low elevation angles are not recommended for v-h-f and u-h-f work. It is for this reason that the horizontal dipole and horizontally-disposed colinear arrays are generally unsuitable for work on these frequencies. Arrays using broadside or end-fire elements do concentrate radiation at low elevation angles and are recommended for v-h-f work. Arrays such as the lazy-H, Sterba curtain, flat-top beam, and arrays with parasitically excited elements are recommended for this work. Dimensions for the first three types of arrays may be determined from the data given in the previous chapter, and reference may be made to the *Table of Wavelengths* given in this chapter.

Arrays using vertically-stacked horizontal dipoles, such as are used by commercial television and FM stations, are capable of giving high gain *without* a sharp horizontal radiation pattern. If sets of crossed dipoles, as shown in figure 1A, are fed 90° out of phase the resulting system is called a *turnstile* antenna. The 90° phase difference between sets of dipoles may be obtained by feeding one set of dipoles with a feed line which is one-quarter wave longer than the feed line to the other set of dipoles. The field strength broadside to one of the dipoles is equal to the field from that dipole alone. The field strength at a point at any other angle is equal to the vector sum of the fields from the two dipoles at that angle. A nearly circular horizontal pattern is produced by this antenna.

A second antenna producing a uniform, horizontally polarized pattern is shown in figure 1B. This antenna employs three dipoles bent to form a circle. All dipoles are excited in phase, and are center fed. A bazooka is included in the system to prevent unbalance in the coaxial feed system.

A third nondirectional antenna is shown in figure 1C. This simple antenna is made of two half-wave elements, of which the end quarter-wavelength of each is bent back 90° . The pattern from this antenna is very much like that of the turnstile antenna. The field from the two quarter-wave sections that are bent back are additive because they are 180° degrees out of phase and are a half wavelength apart. The advantage of this antenna is the simplicity of its feed system and construction.

24-3 Simple Vertical-Polarized Antennas

For general coverage with a single antenna, a single vertical radiator is commonly employed. A two-wire open transmission line is not suitable for use with this type antenna, and coaxial polyethylene feed line such as RG-8/U is to be recommended. Three practical methods of feeding the radiator with concentric line, with a minimum of current induced in the outside of the line, are shown in figure 2. Antenna (A) is known as the *sleeve antenna*, the lower half of the radiator being a large piece of pipe up through which the concentric feed line is run. At (B) is shown the ground-plane vertical, and at (C) a modification of this latter antenna.

The radiation resistance of the ground-plane vertical is approximately 30 ohms, which is not a standard impedance for coaxial line. To obtain a good match, the first quarter wavelength of feeder may be of 52 ohms surge impedance, and the remainder of the line of approximately 75 ohms impedance. Thus, the first quarter-wave section of line is used as a

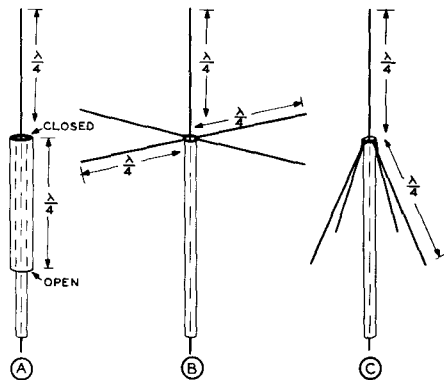

Figure 2
THREE VERTICALLY-POLARIZED
LOW-ANGLE RADIATORS

Shown at (A) is the "sleeve" or "hypodermic" type of radiator. At (B) is shown the ground-plane vertical, and (C) shows a modification of this antenna system which increases the feed-point impedance to a value such that the system may be fed directly from a coaxial line with no standing waves on the feed line.

matching transformer, and a good match is obtained.

In actual practice the antenna would consist of a quarter-wave rod, mounted by means of insulators atop a pole or pipe mast. Elaborate insulation is not required, as the voltage at the lower end of the quarter-wave radiator is very low. Self-supporting rods from 0.25 to 0.28 wavelength would be extended out, as in the illustration, and connected together. As the point of connection is effectively at ground potential, no insulation is required; the horizontal rods may be bolted directly to the supporting pole or mast, even if of metal. The coaxial line should be of the low loss type especially designed for v-h-f use. The outside connects to the junction of the radials, and the inside to the bottom end of the vertical radiator. An antenna of this type is moderately simple to construct and will give a good account of itself when fed at the lower end of the radiator directly by the 52-ohm RG-8/U coaxial cable. Theoretically the standing-wave ratio will be approximately 1.5-to-1 but in practice this moderate s-w-r produces no deleterious effects, even on coaxial cable.

The modification shown in figure 2C permits matching to a standard 50- or 70-ohm flexible coaxial cable without a linear transformer. If the lower rods hug the line and supporting mast

rather closely, the feed-point impedance is about 70 ohms. If they are bent out to form an angle of about 30° with the support pipe the impedance is about 50 ohms.

The number of radial legs used in a ground-plane antenna of either type has an important effect on the feed-point impedance and upon the radiation characteristics of the antenna system. Experiment has shown that three radials is the minimum number that should be used, and that increasing the number of radials above six adds substantially nothing to the effectiveness of the antenna and has no effect on the feed-point impedance. Experiment has shown, however, that the radials should be slightly longer than one-quarter wave for best results. A length of 0.28 wavelength has been shown to be the optimum value. This means that the radials for a 50-Mc. ground-plane vertical antenna should be 65" in length.

Double Skeleton Cone Antenna The bandwidth of the antenna of figure 2C can be increased considerably by substituting several space-tapered rods for the single radiating element, so that the "radiator" and skirt are similar. If a sufficient number of rods are used in the skeleton cones and the angle of revolution is optimized for the particular type of feed line used, this antenna exhibits a very low SWR over a 2 to 1 frequency range. Such an arrangement is illustrated schematically in figure 3.

A Nondirectional Vertical Array Half-wave elements may be stacked in the vertical plane to provide a non-directional pattern with good horizontal gain. An array made up of four half-wave vertical elements is shown in figure 4A. This antenna provides a circular pattern with a gain of about 4.5 db over a vertical dipole. It may be fed with 300-ohm TV-type line. The feedline should be conducted in such a way that the vertical portion of the line is at least one-half wavelength away from the vertical antenna elements. A suitable mechanical assembly is shown in figure 4B for the 144-Mc. and 235-Mc. amateur bands.

24-4 The Discone Antenna

The Discone antenna is a vertically polarized omnidirectional radiator which has very broad band characteristics and permits a simple, rugged structure. This antenna presents a substantially uniform feed-point impedance, suitable for direct connection of a coaxial line, over a range of several octaves. Also, the vertical pattern is suitable for ground-wave

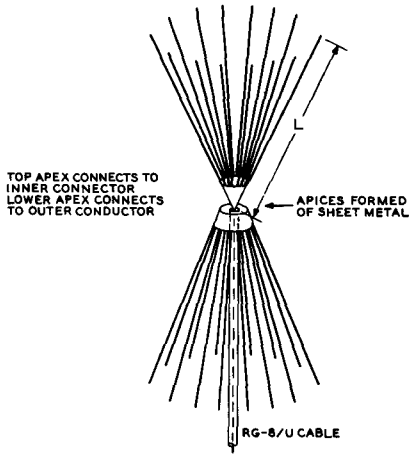

Figure 3
THE DOUBLE SKELETON CONE ANTENNA

A skeleton cone has been substituted for the single element radiator of figure 2C. This greatly increases the bandwidth. If at least 10 elements are used for each skeleton cone and the angle of revolution and element length are optimized, a low SWR can be obtained over a frequency range of at least two octaves. To obtain this order of bandwidth, the element length *L* should be approximately 0.2 wavelength at the lower frequency end of the band, and the angle of revolution optimized for the lowest maximum VSWR within the frequency range to be covered. A greater improvement in the impedance-frequency characteristic can be achieved by adding elements than by increasing the diameter of the elements. With only 3 elements per "cone" and a much smaller angle of revolution a low SWR can be obtained over a frequency range of approximately 1.3 to 1.0 when the element lengths are optimized.

work over several octaves, the gain varying only slightly over a very wide frequency range.

Commercial versions of the Discone antenna for various applications are manufactured by the *Federal Telephone and Radio Corporation*. A Discone type antenna for amateur work can be fabricated from inexpensive materials with ordinary hand tools.

A Discone antenna suitable for multi-band amateur work in the v-h/u-h-f range is shown schematically in figure 5A. The distance *D* should be made approximately equal to a free-space quarter wavelength at the lowest oper-

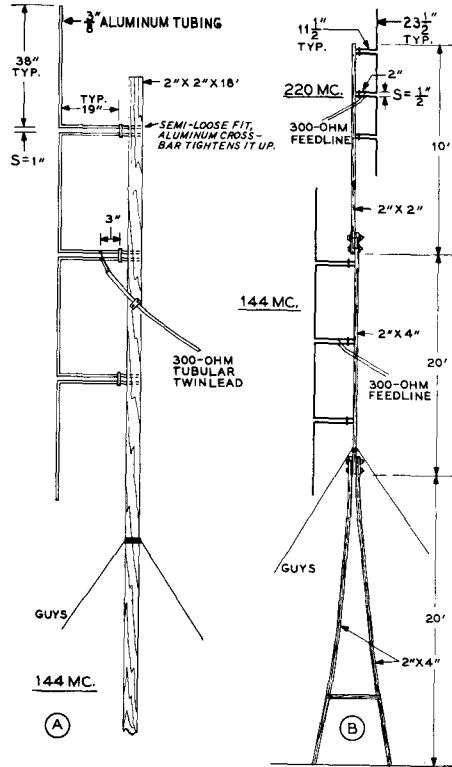

Figure 4
NONDIRECTIONAL ARRAYS FOR 144 MC. AND 235 MC.

On right is shown two band installation. The whole system may easily be disassembled and carried on a ski-rack atop a car for portable use.

ating frequency. The antenna then will perform well over a frequency range of at least 8 to 1. At certain frequencies within this range the vertical pattern will tend to "lift" slightly, causing a slight reduction in gain at zero angular elevation, but the reduction is very slight.

Below the frequency at which the slant height of the conical skirt is equal to a free-space quarter wavelength the standing-wave ratio starts to climb, and below a frequency approximately 20 per cent lower than this the standing-wave ratio climbs very rapidly. This is termed the *cut off frequency* of the antenna. By making the slant height approximately equal to a free-space quarter wavelength at the lowest frequency employed (refer to chart), a

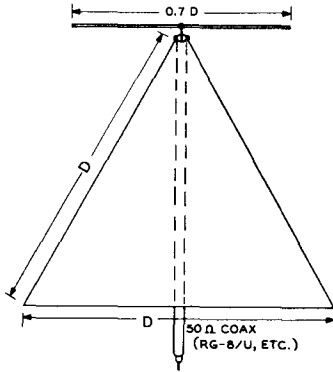

Figure 5A
THE "DISCONE" BROAD-BAND RADIATOR

This antenna system radiates a vertically polarized wave over a very wide frequency range. The "disc" may be made of solid metal sheet, a group of radials, or wire screen; the "cone" may best be constructed by forming a sheet of thin aluminum. A single antenna may be used for operation on the 50, 144, and 220 Mc. amateur bands. The dimension D is determined by the lowest frequency to be employed, and is given in the chart of figure 5B.

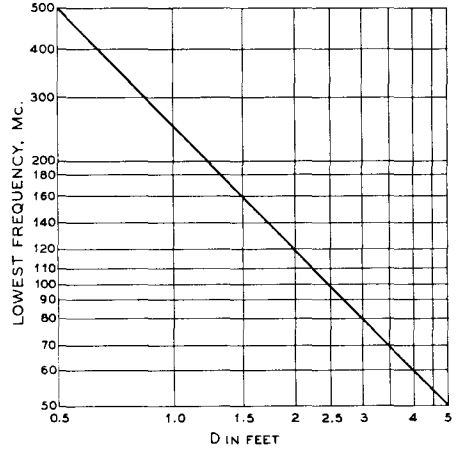

Figure 5B
DESIGN CHART FOR THE "DISCONE" ANTENNA

of the skirt directly to an effective ground plane such as the top of an automobile.

VSWR of less than 1.5 will be obtained throughout the operating range of the antenna.

The Discone antenna may be considered as a cross between an electromagnetic horn and an inverted ground plane unipole antenna. It looks to the feed line like a properly terminated high-pass filter.

Construction Details The top disk and the conical skirt may be fabricated either from sheet metal, screen (such as "hardware cloth"), or 12 or more "spine" radials. If screen is used a supporting framework of rod or tubing will be necessary for mechanical strength except at the higher frequencies. If spines are used, they should be terminated on a stiff ring for mechanical strength except at the higher frequencies.

The top disk is supported by means of three insulating pillars fastened to the skirt. Either polystyrene or low-loss ceramic is suitable for the purpose. The apex of the conical skirt is grounded to the supporting mast and to the outer conductor of the coaxial line. The line is run down through the supporting mast. An alternative arrangement, one suitable for certain mobile applications, is to fasten the base

24-5 Helical Beam Antennas

Most v-h-f and u-h-f antennas are either vertically polarized or horizontally polarized (plane polarization). However, circularly polarized antennas have interesting characteristics which may be useful for certain applications. The installation of such an antenna can effectively solve the problem of horizontal vs. vertical polarization.

A circularly polarized wave has its energy divided equally between a vertically polarized component and a horizontally polarized component, the two being 90 degrees out of phase. The circularly polarized wave may be either "left handed" or "right handed," depending upon whether the vertically polarized component leads or lags the horizontal component.

A circularly polarized antenna will respond to any plane polarized wave whether horizontally polarized, vertically polarized, or diagonally polarized. Also, a circular polarized wave can be received on a plane polarized antenna, regardless of the polarization of the latter. When using circularly polarized antennas at both ends of the circuit, however, both must be left handed or both must be right handed. This offers some interesting possibilities with regard to reduction of QRM. At

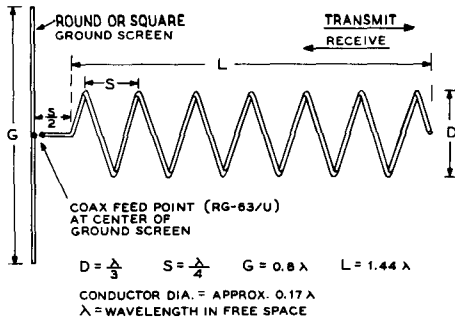

Figure 6
THE "HELICAL BEAM" ANTENNA

This type of directional antenna system gives excellent performance over a frequency range of 1.7 to 1.8 λ . Its dimensions are such that it ordinarily is not practicable, however, for use as a rotatable array on frequencies below about 100 Mc. The center conductor of the feed line should pass through the ground screen for connection to the feed point. The outer conductor of the coaxial line should be grounded to the ground screen.

the time of writing, there has been no standardization of the "twist" for general amateur work.

Perhaps the simplest antenna configuration for a directional beam antenna having circular polarization is the helical beam popularized by Dr. John Kraus, W8JK. The antenna consists simply of a helix working against a ground plane and fed with coaxial line. In the u-h-f and the upper v-h-f range the physical dimensions are sufficiently small to permit construction of a rotatable structure without much difficulty.

When the dimensions are optimized, the characteristics of the helical beam antenna are such as to qualify it as a broad band antenna. An optimized helical beam shows little variation in the pattern of the main lobe and a fairly uniform feed point impedance averaging approximately 125 ohms over a frequency range of as much as 1.7 to 1. The direction of "electrical twist" (right or left handed) depends upon the direction in which the helix is wound.

A six-turn helical beam is shown schematically in figure 6. The dimensions shown will give good performance over a frequency range of plus or minus 20 per cent of the design frequency. This means that the dimensions are not especially critical when the array is to be

used at a single frequency or over a narrow band of frequencies, such as an amateur band. At the design frequency the beam width is about 50 degrees and the power gain about 12 db, referred to a non-directional circularly polarized antenna.

The Ground Screen For the frequency range 100 to 500 Mc. a suitable ground screen can be made from "chicken wire" poultry netting of 1-inch mesh, fastened to a round or square frame of either metal or wood. The netting should be of the type that is galvanized *after* weaving. A small, sheet metal ground plate of diameter equal to approximately $D/2$ should be centered on the screen and soldered to it. Tin, galvanized iron, or sheet copper, is suitable. The outer conductor of the RG-63/U (125 ohm) coax is connected to this plate, and the inner conductor contacts the helix through a hole in the center of the plate. The end of the coax should be taped with *Scotch* electrical tape to keep water out.

The Helix It should be noted that the beam proper consists of six full turns. The start of the helix is spaced a distance of $S/2$ from the ground screen, and the conductor goes directly from the center of the ground screen to the start of the helix.

Aluminum tubing in the "SO" (soft) grade is suitable for the helix. Alternatively, lengths of the relatively soft aluminum electrical conduit may be used. In the v-h-f range it will be necessary to support the helix on either two or four wooden longerons in order to achieve sufficient strength. The longerons should be of as small cross section as will provide sufficient rigidity, and should be given several coats of varnish. The ground plane butts against the longerons and the whole assembly is supported from the balance point if it is to be rotated.

Aluminum tubing in the larger diameters ordinarily is not readily available in lengths greater than 12 feet. In this case several lengths can be spliced by means of short telescoping sections and sheet metal screws.

The tubing is close wound on a drum and then spaced to give the specified pitch. Note that the length of one complete turn when spaced is somewhat greater than the circumference of a circle having the diameter D .

Broad-Band Helical Beam A highly useful v-h-f helical beam which will receive signals with good gain over the complete frequency range from 144 through 225 Mc. may be constructed by using the following dimensions (180 Mc. design center):

- D.....22 in.
- S.....16½ in.
- G.....53 in.
- Tubing o.d.....1 in.

The D and S dimensions are to the center of the tubing. These dimensions must be held rather closely, since the range from 144 through 225 Mc. represents just about the practical limit of coverage of this type of antenna system.

High-Band TV Coverage Note that an array constructed with the above dimensions will give unusually good high-band TV reception in addition to covering the 144-Mc. and 220-Mc. amateur bands and the taxi and police services.

On the 144-Mc. band the beam width is approximately 60 degrees to the half-power points, while the power gain is approximately 11 db over a non-directional circularly polarized antenna. For high-band TV coverage the gain will be 12 to 14 db, with a beam width of about 50 degrees, and on the 220-Mc. amateur band the beam width will be about 40 degrees with a power gain of approximately 15 db.

The antenna system will receive vertically polarized or horizontally polarized signals with equal gain over its entire frequency range. Conversely, it will transmit signals over the same range, which then can be received with equal strength on either horizontally polarized or vertically polarized receiving antennas. The standing-wave ratio will be very low over the complete frequency range if RG-63/U coaxial feed line is used.

24-6 The Corner-Reflector and Horn-Type Antennas

The corner-reflector antenna is a good directional radiator for the v-h-f and u-h-f region. The antenna may be used with the radiating element vertical, in which case the directivity is in the horizontal or azimuth plane, or the system may be used with the driven element

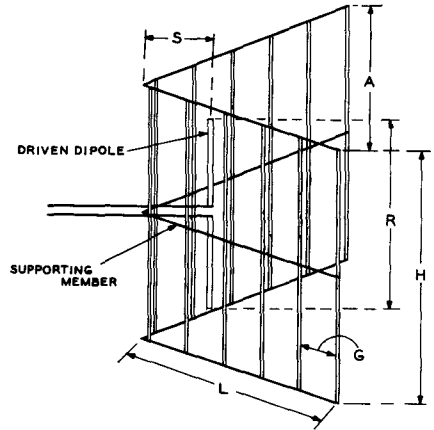

Figure 7
CONSTRUCTION OF THE "CORNER REFLECTOR" ANTENNA

Such an antenna is capable of giving high gain with a minimum of complexity in the radiating system. It may be used either with horizontal or vertical polarization. Design data for the antenna is given in the Corner-Reflector Design Table.

horizontal in which case the radiation is horizontally polarized and most of the directivity is in the vertical plane. With the antenna used as a horizontally polarized radiating system the array is a very good low-angle beam array although the nose of the horizontal pattern is still quite sharp. When the radiator is oriented vertically the corner reflector operates very satisfactorily as a direction-finding antenna.

Design data for the corner-reflector antenna is given in figure 7 and in the chart *Corner-Reflector Design Data*. The planes which make up the reflecting corner may be made of solid sheets of copper or aluminum for the u-h-f bands, although spaced wires with the ends soldered together at top and bottom may be used as the reflector on the lower frequencies.

CORNER-REFLECTOR DESIGN DATA									
Corner Angle	Freq. Band, Mc.	R	S	H	A	L	G	Feed Imped.	Approx. Gain, db
90	50	110"	82"	140"	200"	230"	18"	72	10
60	50	110"	115"	140"	230"	230"	18"	70	12
60	144	38"	40"	48"	100"	100"	5"	70	12
60	220	24.5"	25"	30"	72"	72"	3"	70	12
60	420	13"	14"	18"	36"	36"	screen	70	12

NOTE: Refer to figure 7 for construction of corner-reflector antenna.

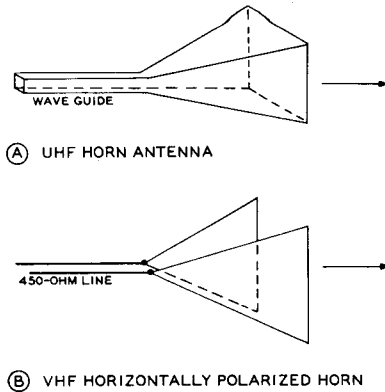

Figure 8

TWO TYPES OF HORN ANTENNAS

The "two sided horn" of Figure 8B may be fed by means of an open-wire transmission line.

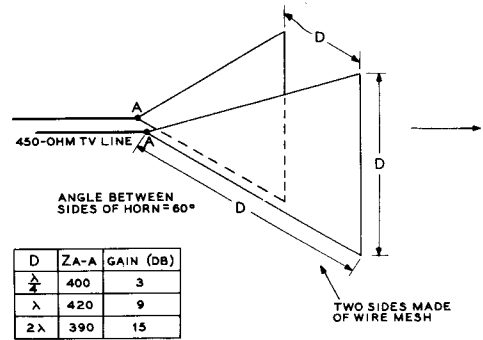

Figure 9

THE 60° HORN ANTENNA FOR USE ON FREQUENCIES ABOVE 144 MC.

Copper screen may also be used for the reflecting planes.

The values of spacing given in the corner-reflector chart have been chosen such that the center impedance of the driven element would be approximately 70 ohms. This means that the element may be fed directly with 70-ohm coaxial line, or a quarter-wave matching transformer such as a "Q" section may be used to provide an impedance match between the center-impedance of the element and a 460-ohm line constructed of no. 12 wire spaced 2 inches.

In many v-h-f antenna systems, waveguide transmission lines are terminated by pyramidal horn antennas. These horn antennas (figure 8A) will transmit and receive either horizontally or vertically polarized waves. The use of waveguides at 144 Mc. and 235 Mc., however, is out of the question because of the relatively large dimensions needed for a waveguide operating at these low frequencies.

A modified type of horn antenna may still be used on these frequencies, since only one particular plane of polarization is of interest to the amateur. In this case, the horn antenna can be simplified to two triangular sides of the pyramidal horn. When these two sides are insulated from each other, direct excitation at the apex of the horn by a two-wire transmission line is possible.

In a normal pyramidal horn, all four triangular sides are covered with conducting material, but when horizontal polarization alone is of interest (as in amateur work) only the vertical areas of the horn need be used. If vertical polarization is required, only the horizontal areas

of the horn are employed. In either case, the system is unidirectional, away from the apex of the horn. A typical horn of this type is shown in figure 8B. The two metallic sides of the horn are insulated from each other, and the sides of the horn are made of small mesh "chicken wire" or copper window screening.

A pyramidal horn is essentially a high-pass device whose low frequency cut-off is reached when a side of the horn is $\frac{1}{2}$ wavelength. It will work up to infinitely high frequencies, the gain of the horn increasing by 6 db every time the operating frequency is doubled. The power gain of such a horn compared to a $\frac{1}{2}$ wave dipole at frequencies higher than cut-off is:

$$\text{Power gain (db)} = \frac{8.4 A^2}{\lambda^2}$$

where A is the frontal area of the mouth of the horn. For the 60 degree horn shown in figure 8B the formula simplifies to:

$$\text{Power gain (db)} = 8.4 D^2, \text{ when } D \text{ is expressed in terms of wavelength}$$

When D is equal to one wavelength, the power gain of the horn is approximately 9 db. The gain and feed point impedance of the 60 degree horn are shown in figure 9. A 450 ohm open wire TV-type line may be used to feed the horn.

24-7 VHF Horizontal Rhombic Antenna

For v-h-f transmission and reception in a fixed direction, a horizontal rhombic permits

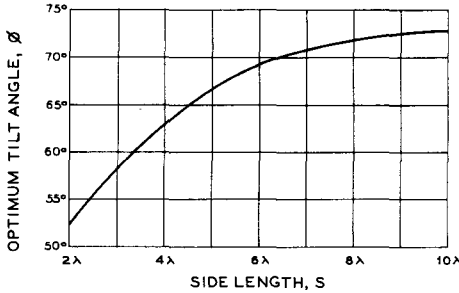

Figure 10
V-H-F RHOMBIC ANTENNA DESIGN CHART

The optimum tilt angle (see figure 11) for "zero-angle" radiation depends upon the length of the sides.

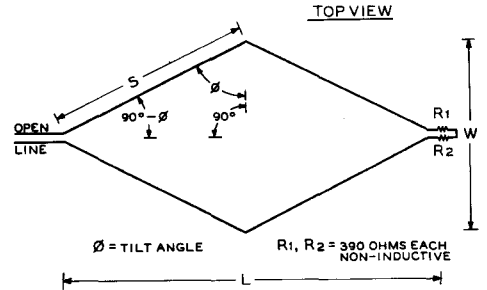

Figure 11
V-H-F RHOMBIC ANTENNA CONSTRUCTION

10 to 16 db gain with a simpler construction than does a phased dipole array, and has the further advantage of being useful over a wide frequency range.

Except at the upper end of the v-h-f range a rhombic array having a worthwhile gain is too large to be rotated. However, in locations 75 to 150 miles from a large metropolitan area a rhombic array is ideally suited for working into the city on extended (horizontally polarized) ground-wave while at the same time making an ideal antenna for TV reception.

The useful frequency range of a v-h-f rhombic array is about 2 to 1, or about plus 40% and minus 30% from the design frequency. This coverage is somewhat less than that of a high-frequency rhombic used for sky-wave communication. For ground-wave transmission or reception the only effective vertical angle is that of the horizon, and a frequency range greater than 2 to 1 cannot be covered with a rhombic array without an excessive change in the vertical angle of maximum radiation or response.

The dimensions of a v-h-f rhombic array are determined from the design frequency and figure 10, which shows the proper tilt angle (see figure 11) for a given leg length. The gain of a rhombic array increases with leg length. There is not much point in constructing a v-h-f rhombic array with legs shorter than about 4 wavelengths, and the beam width begins to become excessively sharp for leg lengths greater than about 8 wavelengths. A leg length of 6 wavelengths is a good compromise between beam width and gain.

The tilt angle given in figure 10 is based upon a wave angle of zero degrees. For leg lengths of 4 wavelengths or longer, it will be

necessary to elongate the array a few per cent (pulling in the sides slightly) if the horizon elevation exceeds about 3 degrees.

Table I gives dimensions for two dual purpose rhombic arrays. One covers the 6-meter amateur band and the "low" television band. The other covers the 2-meter amateur band, the "high" television band, and the 1¼-meter amateur band. The gain is approximately 12 db over a matched half wave dipole and the beam width is about 6 degrees.

The Feed Line The recommended feed line is an open-wire line having a surge impedance between 450 and 600 ohms. With such a line the VSWR will be less than 2 to 1. A line with two-inch spacing is suitable for frequencies below 100 Mc., but one-inch spacing (such as used in the *Gonset Line* for TV installations) is recommended for higher frequencies.

The Termination If the array is to be used only for reception, a suitable termination consists of two 390-ohm carbon re-

	6 METERS AND LOW BAND TV	2 METERS, HIGH BAND TV, AND 1¼ METERS
S (side)	90'	32'
L (length)	166' 10"	59' 4"
W (Width)	67' 4"	23' 11"
S = 6 wavelengths at design frequency Tilt angle = 68°		

TABLE I.

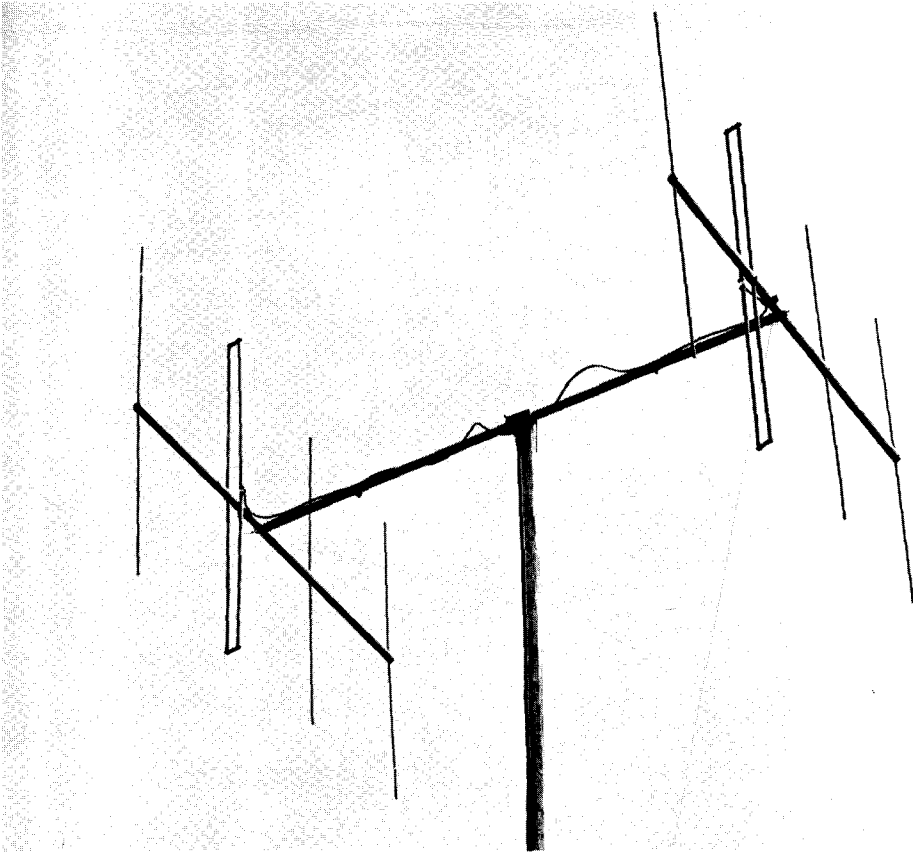

Figure 14
THE EIGHT-ELEMENT 144-MC. ARRAY IN A HORIZONTAL POSITION

appropriate cord. Hence, the operation is based on the offset head sketched in figure 13. Although a wood mast has been used, the same system may be used with a pipe mast.

The 40-inch lengths of RG-59/U cable (electrically $\frac{3}{4}$ wavelength) running from the center of each folded dipole driven element to the coaxial T-junction allow enough slack to permit free movement of the main boom when changing polarity. Type RG-8/U cable is run from the T-junction to the operating position. Measured standing-wave ratio was less than 2:1 over the 144 to 148 Mc. band, with the lengths and spacings given in figure 13.

Construction of the Array Most of the constructional aspects of the antenna array are self-evident from figure

13. However, the pointers given in the following paragraphs will be of assistance to those wishing to reproduce the array.

The drilling of holes for the small elements should be done carefully on accurately marked centers. A small angular error in the drilling of these holes will result in a considerable misalignment of the elements after the array is assembled. The same consideration is true of the filing out of the rounded notches in the ends of the main boom for the fitting of the two antenna booms.

Short lengths of wood dowel are used freely in the construction of the array. The ends of the small elements are plugged with an inch or so of dowel, and the ends of the antenna booms are similarly treated with larger discs pressed into place.

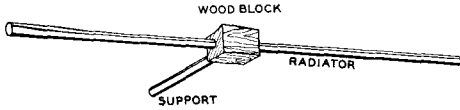

Figure 16
THE MOUNTING BLOCK FOR EACH SET OF ELEMENTS

These tubes are welded onto the center tube of each group of three horizontal bracing tubes, and are so located to support the horizontal dipole at its exact center. The dipoles are attached to the supporting rods by means of small phenolic insulating blocks, as shown in figure 16. The radiators are therefore insulated from the screen reflector. The inner tips of the radiators are held by small polystyrene blocks for rigidity, and are cross connected to each other by a transposed length of TV-type 400 ohm open wire line. The entire array is fed at the point A-A, illustrated in figure 15.

The matching system for the beam is mounted behind the reflector screen, and is shown in figure 17. A quarter-wave transformer (B) drops the relatively high impedance of the antenna array to a suitable value for the low impedance balun (D). An adjustable matching stub (C) and two variable capacitors (C_1 and C_2) are employed for impedance matching. The two variable capacitors are mounted in a

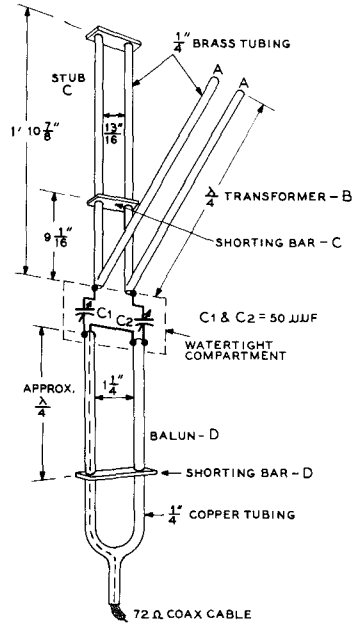

Figure 17
THE MATCHING UNIT IN DETAIL FOR THE PEIPL BEAM DESIGN, WHICH ALLOWS THE USE OF 72-OHM COAX

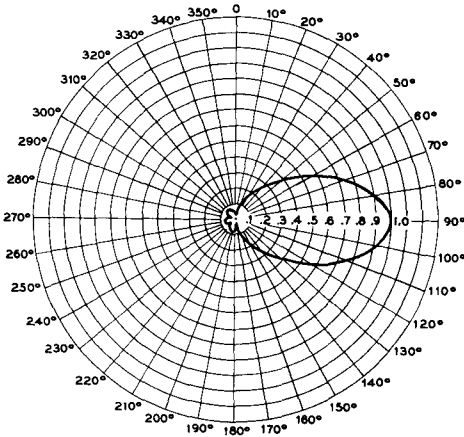

Figure 18
HORIZONTAL RADIATION PATTERN OF THE PEIPL ARRAY. THE FRONT-TO-BACK RATIO IS ABOUT 28 db IN AMPLITUDE, AND THE FORWARD GAIN APPROXIMATELY 15 db.

watertight box, with the balun and matching stubs entering the bottom and top of the box, respectively.

The matching procedure is carried out by the use of a standing wave meter (SWR bridge). A few watts of power are fed to the array through the SWR meter, and the setting of the shorting stub on C and the setting of the two variable capacitors are adjusted for lowest SWR at the chosen operating frequency. The capacity settings of the two variable capacitors should be equal. The final adjustment is to set the shorting stub of the balun (D) to remove any residual reactance that might appear on the transmission line. With proper adjustment, the VSWR of the array may be held to less than 1.5 to 1 over a 2 megacycle range of the 2-meter band.

The horizontal radiation pattern of this array is shown in figure 18.

Long Yagi Antennas For a given power gain, the Yagi antenna can be built lighter, more compact, and with less wind resistance than any other type.

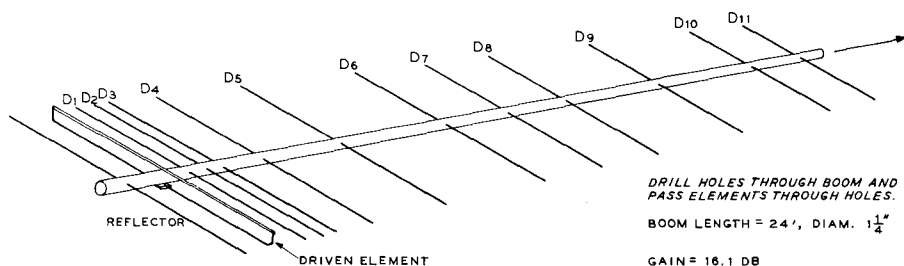

ELEMENT DIMENSIONS, 2 METER BAND

ELEMENT (DIAM. 1/8")	LENGTH				SPACING FROM DIPOLE
	144 MC.	145 MC.	146 MC.	147 MC.	
REFLECTOR	41"	40 ³ / ₄ "	40 ⁷ / ₁₆ "	40 ³ / ₁₆ "	19"
DIRECTORS	36 ³ / ₄ "	36 ¹ / ₂ "	36 ³ / ₈ "	36 ³ / ₁₆ "	D1 = 7" D2 = 14.5" D3 = 22" D4 = 38" D5 = 70" D6 = 102" D7 = 134" D8 = 166" D9 = 198" D10 = 230" D11 = 242"

Figure 19

DESIGN DIMENSIONS FOR A 2-METER "LONG YAGI" ANTENNA

On the other hand, if a Yagi array of the same approximate size and weight as another antenna type is built, it will provide a higher order of power gain and directivity than that of the other antenna.

The power gain of a Yagi antenna increases directly with the physical length of the array. The maximum practical length is entirely a mechanical problem of physically supporting the long series of director elements, although when the array exceeds a few wavelengths in length the element lengths, spacings, and Q's become more and more critical. The effectiveness of the array depends upon a proper combination of the mutual coupling loops between adjacent directors and between the first director and the driven element.

Practically all work on Yagi antennas with more than three or four elements has been on an experimental, cut-and-try basis. Figure 19

provides dimensions for a typical Long Yagi antenna for the 2-meter VHF band. Note that all directors have the same physical length. If the long Yagi is designed so that the directors gradually decrease in length as they progress from the dipole bandwidth will be increased, and both side lobes and forward gain will be reduced. One advantage gained from staggered director length is that the array can be shortened and lengthened by adding or taking away directors without the need for retuning the remaining group of parasitic elements. When all directors are the same length, they must be all shortened *en masse* as the array is lengthened, and vice-versa when the array is shortened.

A full discussion of Long Yagi antennas, including complete design and construction information may be had in the *VHF Handbook*, available through Radio Publications, Inc., Wilton., Conn.

Rotary Beams

The rotatable antenna array has become almost standard equipment for operation on the 28-Mc. and 50-Mc. bands and is commonly used on the 14-Mc. and 21-Mc. bands and on those frequencies above 144 Mc. The rotatable array offers many advantages for both military and amateur use. The directivity of the antenna types commonly employed, particularly the unidirectional arrays, offers a worthwhile reduction in interference from undesired directions. Also, the increase in the ratio of low-angle radiation plus the theoretical gain of such arrays results in a relatively large increase in both the transmitted signal and the signal intensity from a station being received.

A significant advantage of a rotatable antenna array in the case of the normal station is that a relatively small amount of space is required for erection of the antenna system. In fact, one of the best types of installation uses a single telephone pole with the rotating structure holding the antenna mounted atop the pole. To obtain results in all azimuth directions from fixed arrays comparable to the gain and directivity of a single rotatable three-element parasitic beam would require several acres of surface.

There are two normal configurations of radiating elements which, when horizontally polarized, will contribute to obtaining a low angle of radiation. These configurations are the end-fire array and the broadside array. The con-

ventional three- or four-element rotary beam may properly be called a *unidirectional parasitic end-fire array*, and is actually a type of *yagi* array. The flat-top beam is a type of *bidirectional end-fire array*. The *broadside type* of array is also quite effective in obtaining low-angle radiation, and although widely used in FM and TV broadcasting has seen little use by amateur stations in rotatable arrays.

25-1 Unidirectional Parasitic End-Fire Arrays (Yagi Type)

If a single parasitic element is placed on one side of a driven dipole at a distance of from 0.1 to 0.25 wavelength the parasitic element can be tuned to make the array substantially unidirectional.

This simple array is termed a *two element parasitic beam*.

25-2 The Two Element Beam

The two element parasitic beam provides the greatest amount of gain per unit size of any array commonly used by radio amateurs.

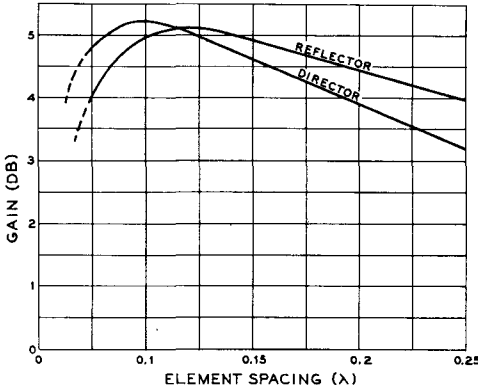

Figure 1

GAIN VS ELEMENT SPACING FOR A TWO-ELEMENT CLOSE-SPACED PARASITIC BEAM ANTENNA WITH PARASITIC ELEMENT OPERATING AS A DIRECTOR OR REFLECTOR

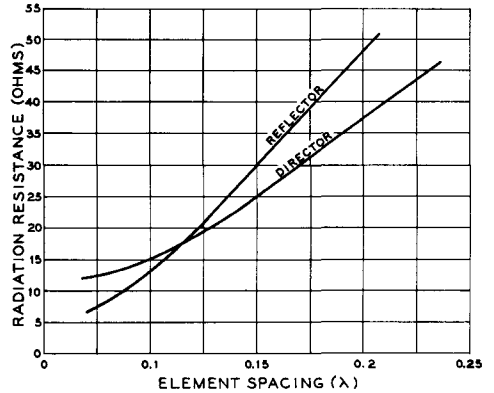

Figure 2

RADIATION RESISTANCE AS A FUNCTION OF ELEMENT SPACING FOR A TWO-ELEMENT PARASITIC ARRAY

Such an antenna is capable of a signal gain of 5 db over a dipole, with a front-to-back ratio of 7 db to 15 db, depending upon the adjustment of the parasitic element. The parasitic element may be used either as a director or as a reflector.

The optimum spacing for a reflector in a two-element array is approximately 0.13 wavelength and with optimum adjustment of the length of the reflector a gain of approximately 5 db will be obtained, with a feed-point resistance of about 25 ohms.

If the parasitic element is to be used as a director the optimum spacing between it and the driven element is 0.11 wavelength. The gain will theoretically be slightly greater than with the optimum adjustment for a reflector (about 5.5 db) and the radiation resistance will be in the vicinity of 17 ohms.

The general characteristics of a two-element parasitic array may be seen in figures 1, 2 and 3. The gain characteristics of a two-element array when the parasitic element is used as a director or as a reflector are shown. It can be seen that the director provides a maximum of 5.3 db gain at a spacing of slightly greater than 0.1 wavelength from the antenna. In the interests of greatest power gain and size conservation, therefore, the choice of a parasitic director would be wiser than the choice of a parasitic reflector, although the gain difference between the two is small.

Figure 2 shows the relationship between the element spacing and the radiation resist-

ance for the two element parasitic array for both the reflector and the director case. Since the optimum antenna-director spacing for maximum gain results in an antenna radiation resistance of about 17 ohms, and the optimum antenna-reflector spacing for maximum gain results in an antenna radiation resistance of about 25 ohms, it may be of advantage in some instances to choose the antenna with the higher radiation resistance, assuming other factors to be equal.

Figure 3 shows the front-to-back ratio for the two element parasitic array for both the reflector and director cases. To produce these curves, the elements were tuned for maximum gain of the array. Better front-to-back ratios may be obtained at the expense of array gain, if desired, but the general shape of the curves remains the same. It can be readily observed that operation of the parasitic element as a reflector produces relatively poor front-to-back ratios except when the element spacing is greater than 0.15 wavelength. However, at this element spacing, the gain of the array begins to suffer.

Since a radiation resistance of 17 ohms is not unduly hard to match, it can be argued that the best all-around performance may be obtained from a two element parasitic beam employing 0.11 element spacing, with the parasitic element tuned to operate as a director. This antenna will provide a forward gain of 5.3 db, with a front-to-back ratio of 10 db, or slightly greater. Closer spacing than 0.11

wavelength may be employed for greater front-to-back ratios, but the radiation resistance of the array becomes quite low, the bandwidth of the array becomes very narrow, and the tuning becomes quite critical. Thus the Q of the antenna system will be *increased* as the spacing between the elements is *decreased*, and smaller optimum frequency coverage will result.

Element Lengths When the parasitic element of a two-element array is used as a director, the following formulas may be used to determine the lengths of the driven element and the parasitic director, assuming an element diameter-to-length ratio of 200 to 400:

$$\text{Driven element length (feet)} = \frac{476}{F_{Mc}}$$

$$\text{Director length (feet)} = \frac{450}{F_{Mc}}$$

$$\text{Element spacing (feet)} = \frac{120}{F_{Mc}}$$

Figure 4
FIVE ELEMENT 28 MC BEAM
ANTENNA AT W6SAI

Antenna boom is made of twenty foot length of Sears, Roebuck Co. three-inch aluminum irrigation pipe. Spacing between elements is five feet. Elements are made of twelve foot lengths of 7/8-inch aluminum tubing, with extension tips made of 3/4-inch tubing. Gamma matching device, element clamps, and "Oxen Yoke" element-to-boom clamps are made by Continental Electronics & Sound Co., Dayton 27, Ohio. Beam dimensions are taken from figure 5.

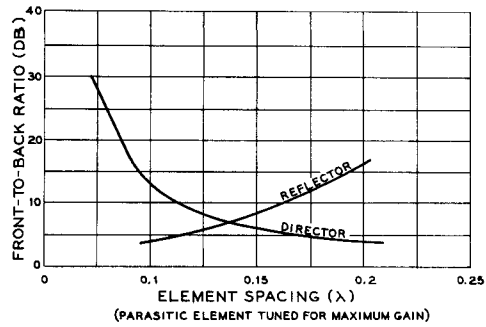
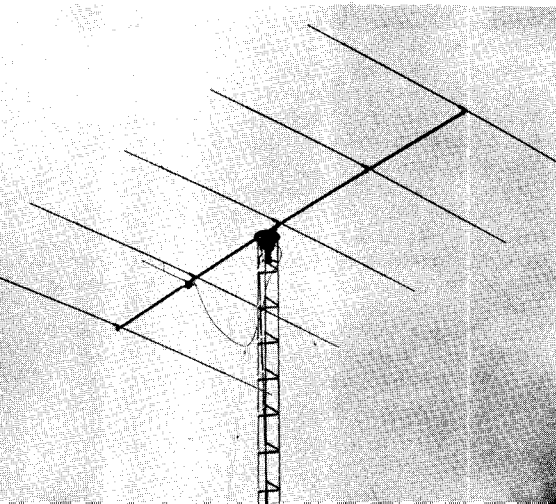

Figure 3
FRONT-TO-BACK RATIO AS A FUNCTION
OF ELEMENT SPACING FOR A TWO-ELE-
MENT PARASITIC ARRAY

The effective bandwidth taken between the 1.5/1 standing wave points of an array cut to the above dimensions is about 2.5% of the operating frequency. This means that an array pre-cut to a frequency of 14,150 kilocycles would have a bandwidth of 350 kilocycles (plus or minus 175 kilocycles of the center frequency), and therefore would be effective over the whole 20 meter band. In like fashion, a 15 meter array should be pre-cut to 21,200 kilocycles.

A beam designed for use on the 10-meter band would have an effective bandwidth of some 700 kilocycles. Since the 10-meter band is 1700 kilocycles in width, the array should either be cut to 28,500 kilocycles for operation in the low frequency portion of the band, or to 29,200 kilocycles for operation in the high frequency portion of the band. Operation of the antenna outside the effective bandwidth will increase the SWR on the transmission line, and noticeably degrade both the gain and front-to-back ratio performance. The height above ground also influences the F/B ratio.

25-3 The Three-Element Array

The three-element array using a director, driven element, and reflector will exhibit as much as 30 db front-to-back ratio and 20 db front-to-side ratio for *low-angle radiation*. The theoretical gain is about 9 db over a dipole in free space. In actual practice, the array will often show 7 to 10 db apparent gain over a horizontal dipole placed the same height above ground (at 28 and 14 Mc.).

The use of more than three elements is desirable when the length of the supporting structure is such that spacings of approximately

0.2 wavelength between elements becomes possible. Four-element arrays are quite common on the 28-Mc. and 50-Mc. bands, and five elements are sometimes used for increased gain and discrimination. As the number of elements is increased the gain and front-to-back ratio increases but the radiation resistance decreases and the bandwidth or frequency range over which the antenna will operate without reduction in effectiveness is decreased.

Material for Elements While the elements may consist of wire supported on a wood framework, self-supporting elements of tubing are much to be preferred. The latter type array is easier to construct, looks better, is no more expensive, and avoids the problem of getting sufficiently good insulation at the ends of the elements. The voltages reach such high values towards the ends of the elements that losses will be excessive, unless the insulation is excellent.

The elements may be fabricated of thin-walled steel conduit, or hard drawn thin-walled copper tubing, but dural tubing is much better. Or, if you prefer, you may purchase tapered copper-plated steel tubing elements designed especially for the purpose. Kits are available complete with rotating mechanism and direction indicator, for those who desire to purchase the whole system ready to put up.

Element Spacing The optimum spacing for a two-element array is, as has been mentioned before, approximately 0.11 wavelength for a director and 0.13 wavelength for a reflector. However, when both a director and a reflector are combined with the driven element to make up a three-element array the optimum spacing is established by the bandwidth which the antenna will be required to cover. Wide spacing (of the order of 0.25 wavelength between elements) will result in greater bandwidth for a specified maximum standing-wave ratio on the antenna transmission line. Smaller spacings may be used when boom length is an important consideration, but for a specified standing-wave ratio and forward gain the frequency coverage will be smaller. Thus the Q of the antenna system will be *increased* as the spacing between the elements is *decreased*, resulting in smaller frequency coverage, and at the same time the feed-point impedance of the driven element will be decreased.

For broad-band coverage, such as the range from 26.96 to 29.7 Mc. or from 50 to 54 Mc., 0.2 wavelength spacing from the driven element to each of the parasitic elements is rec-

ommended. For narrower bandwidth, such as would be adequate for the 14.0 to 14.4 Mc. band or the 144 to 148 Mc. band, the radiator to parasitic element spacing may be reduced to 0.12 wavelength, while still maintaining adequate array bandwidth for the amateur band in question.

Length of the Parasitic Elements Experience has shown that it is practical to cut the parasitic elements of a three-element parasitic array to a predetermined length before the installation of such an antenna. A pre-tuned antenna such as this will give good signal gain, adequate front-to-back ratio, and good bandwidth factor. By carefully tuning the array after it is in position the gain may be increased by a fraction of a db, and the front-to-back ratio by several db. However the slight improvement in performance is usually not worth the effort expended in tuning time.

The closer the lengths of the parasitic elements are to the resonant length of the driven element, the lower will be the feed-point resistance of the driven element, and the smaller will be the bandwidth of the array. Hence, for wide frequency coverage the director should be considerably shorter, and the reflector considerably longer than the driven element. For example, the director should still be less than a resonant half wave at the upper frequency limit of the range wherein the antenna is to be operated, and the reflector should still be long enough to act as a reflector at the lower frequency limit. Another way of stating the same thing is to say, in the case of an array to cover a wide frequency range such as the amateur range from 26.96 to 29.7 Mc. or the width of a low-band TV channel, that the director should be cut for the upper end of the band and the reflector for the lower end of the band. In the case of the 26.96 to 29.7 Mc. range this means that the director should be about 8 per cent shorter than the driven element and the reflector should be about 8 per cent longer. Such an antenna will show a relatively constant gain of about 6 db over its range of coverage, and the pattern will not reverse at any point in the range.

Where the frequency range to be covered is somewhat less, such as a high-band TV channel, the 14.0 to 14.4 Mc. amateur band, or the lower half of the amateur 28-Mc. phone band, the reflector should be about 5 per cent longer than the driven element, and the director about 5 per cent shorter. Such an antenna will perform well over its rated frequency band, will not reverse its pattern over this band, and will show a signal gain of 7 to 8 db. See figure 5 for design figures for 3-element arrays.

TYPE	DRIVEN ELEMENT LENGTH	REFLECTOR LENGTH	1ST DIRECTOR LENGTH	2ND DIRECTOR LENGTH	3RD DIRECTOR LENGTH	SPACING BETWEEN ELEMENTS	APPROX. GAIN DB	APPROX. RADIATION RESISTANCE (Ω)
3-ELEMENT	$\frac{473}{F(\text{MC})}$	$\frac{501}{F(\text{MC})}$	$\frac{445}{F(\text{MC})}$	—	—	.15-.15	7.5	20
3-ELEMENT	$\frac{473}{F(\text{MC})}$	$\frac{501}{F(\text{MC})}$	$\frac{450}{F(\text{MC})}$	—	—	.25-.25	8.5	35
4-ELEMENT	$\frac{473}{F(\text{MC})}$	$\frac{501}{F(\text{MC})}$	$\frac{450}{F(\text{MC})}$	$\frac{450}{F(\text{MC})}$	—	.2-.2-.2	9.5	20
5-ELEMENT	$\frac{473}{F(\text{MC})}$	$\frac{501}{F(\text{MC})}$	$\frac{450}{F(\text{MC})}$	$\frac{450}{F(\text{MC})}$	$\frac{450}{F(\text{MC})}$.2-.2-.2-.2	10.0	15

Figure 5
DESIGN CHART FOR PARASITIC ARRAYS (DIMENSIONS GIVEN IN FEET)

More Than Three Elements A small amount of additional gain may be obtained through use of more than two parasitic elements, at the expense of reduced feed-point impedance and lessened bandwidth. One additional director will add about 1 db, and a second additional director (making a total of five elements including the driven element) will add slightly less than one db more. In the v-h-f range, where the additional elements may be added without much difficulty, and where required bandwidths are small, the use of more than two parasitic elements is quite practicable.

Stacking of Yagi Arrays Parasitic arrays (yagis) may be stacked to provide additional gain in the same manner that dipoles may be stacked. Thus if an array of six dipoles would give a gain of 10 db, the substitution of yagi arrays for each of the dipoles would add the gain of *one* yagi array to the gain obtained with the dipoles. However, the yagi arrays *must be more widely spaced* than the dipoles to obtain this theoretical improvement. As an example, if six 5-element yagi arrays having a gain of about 10 db were substituted for the dipoles, with appropriate increase in the spacing between the arrays, the gain of the whole system would approach the sum of the two gains, or 20 db. A group of arrays of yagi antennas, with recommended spacing and approximate gains, are illustrated in figure 6.

25-4 Feed Systems for Parasitic (Yagi) Arrays

The table of figure 5 gives, in addition to other information, the approximate radiation resistance referred to the center of the driven element of multi-element parasitic arrays. It is obvious, from these low values of radiation

resistance, that especial care must be taken in materials used and in the construction of the elements of the array to insure that ohmic losses in the conductors will not be an appreciable percentage of the radiation resistance. It is also obvious that some method of impedance transformation must be used in many cases to match the low radiation resistance of these antenna arrays to the normal range of characteristic impedance used for antenna transmission lines.

A group of possible methods of impedance matching is shown in figures 7, 8, 9 and 10. All these methods have been used but certain of them offer advantages over some of the other methods. Generally speaking it is not mechanically desirable to break the center of the driven element of an array for feeding the system. Breaking the driven element rules out the practicability of building an all-metal or "plumber's delight" type of array, and imposes mechanical limitations with any type of construction. However, when continuous rotation is desired, an arrangement such as shown in figure 9D utilizing a broken driven element with a rotatable transformer for coupling from the antenna transmission line to the driven element has proven to be quite satisfactory. In fact the method shown in figure 9D is probably the most practicable method of feeding the driven element when continuous rotation of the antenna array is required.

The feed systems shown in figure 7 will, under normal conditions, show the lowest losses of any type of feed system since the currents flowing in the matching network are the lowest of all the systems commonly used. The "Folded Element" match shown in figure 7A and the "Yoke" match shown in figure 7B are the most satisfactory electrically of all standard feed methods. However, both methods require the extension of an additional conductor out to the end of the driven element as a portion of the matching system. The folded-element match is best on the 50-Mc. band and

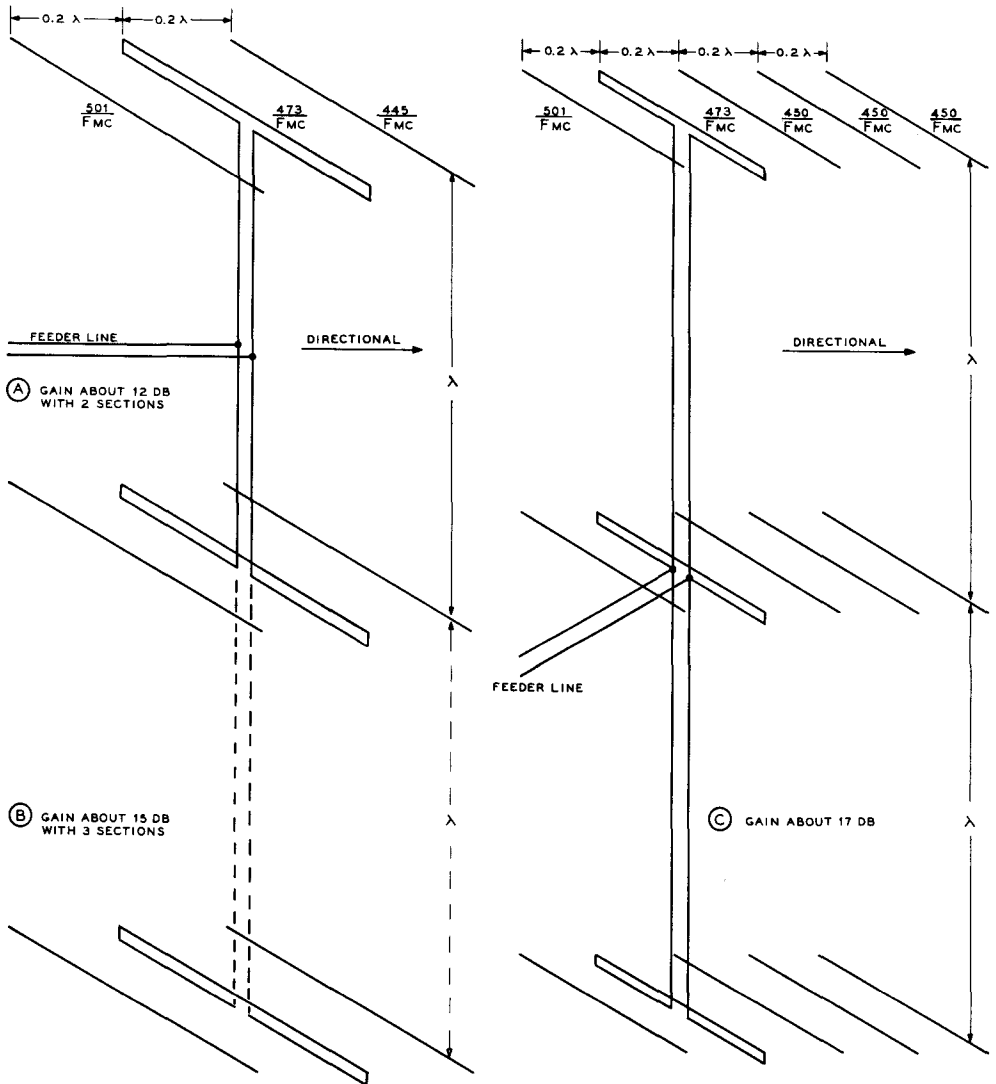

Figure 6
STACKED YAGI ARRAYS

It is possible to attain a relatively large amount of gain over a limited bandwidth with stacked yagi arrays. The two-section array at (A) will give a gain of about 12 db, while adding a third section will bring the gain up to about 15 db. Adding two additional parasitic directors to each section, as at (C) will bring the gain up to about 17 db.

higher where the additional section of tubing may be supported below the main radiator element without undue difficulty. The yoke-match is more satisfactory mechanically on the 28-

Mc. and 14-Mc. bands since it is only necessary to suspend a wire below the driven element proper. The wire may be spaced below the self-supporting element by means of several

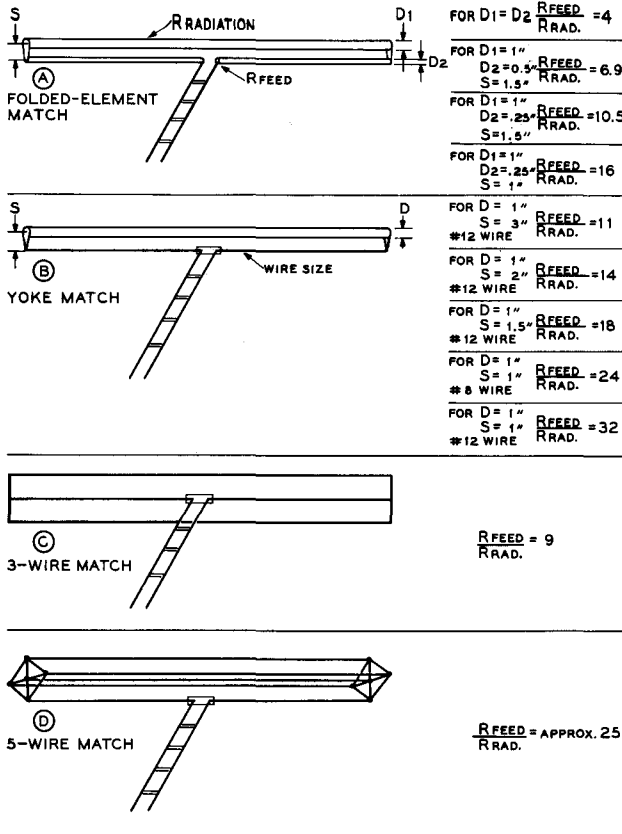

Figure 7
DATA FOR
FOLDED-ELEMENT
MATCHING SYSTEMS

In all normal applications of the data given the main element as shown is the driven element of a multi-element parasitic array. Directors and reflectors have not been shown for the sake of clarity.

small strips of polystyrene which have been drilled for both the main element and the small wire and threaded on the main element.

The Folded-Element Match Calculations The calculation of the operating conditions of the folded-element matching system and the yoke match, as shown in figures 7A and 7B is relatively simple. A selected group of operating conditions has been shown on the drawing of figure 7. In applying the system it is only necessary to multiply the ratio of feed to radiation resistance (given in the figures to the right of the suggested operating dimensions in figure 7) by the radiation resistance of the antenna system to obtain the impedance of the cable to be used in feeding the array. Approximate values of radiation resistance for a number of commonly used parasitic-element arrays are given in figure 5.

As an example, suppose a 3-element array with 0.15D-0.15R spacing between elements is

to be fed by means of a 465-ohm line constructed of no. 12 wire spaced 2 inches. The approximate radiation resistance of such an antenna array will be 20 ohms. Hence we need a ratio of impedance step up of 23 to obtain a match between the characteristic impedance of the transmission line and the radiation resistance of the driven element of the antenna array. Inspection of the ratios given in figure 7 shows that the fourth set of dimensions given under figure 7B will give a 24-to-1 step up, which is sufficiently close. So it is merely necessary to use a 1-inch diameter driven element with a no. 8 wire spaced on 1 inch centers (1/2 inch below the outside wall of the 1-inch tubing) below the 1-inch element. The no. 8 wire is broken and a 2-inch insulator placed in the center. The feed line then carries from this insulator down to the transmitter. The center insulator should be supported rigidly from the 1-inch tube so that the spacing between the piece of tubing and the no. 8 wire will be accurately maintained.

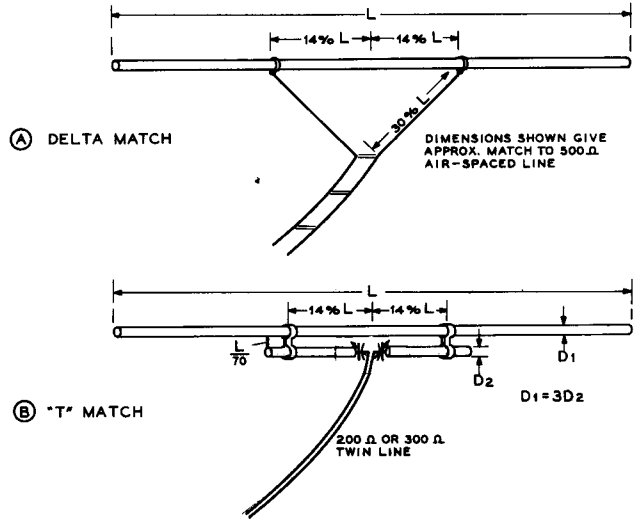

Figure 8
AVERAGE DIMENSIONS
FOR THE DELTA AND
"T" MATCH

In many cases it will be desired to use the folded-element or yoke matching system with different sizes of conductors or different spacings than those shown in figure 7. Note, then, that the impedance transformation ratio of these types of matching systems is dependent both upon the ratio of conductor diameters and upon their spacing. The following equation has been given by Roberts (*RCA Review*, June, 1947) for the determination of the impedance transformation when using different diameters in the two sections of a folded element:

$$\text{Transformation ratio} = \left(1 + \frac{Z_1}{Z_2} \right)^2$$

In this equation Z_1 is the characteristic impedance of a line made up of the smaller of the two conductor diameters spaced the center-to-center distance of the two conductors in the antenna, and Z_2 is the characteristic impedance of a line made up of two conductors the size of the larger of the two. This assumes that the feed line will be connected in series with the smaller of the two conductors so that an impedance step up of greater than four will be obtained. If an impedance step up of less than four is desired, the feed line is connected in series with the larger of the two conductors and Z_1 in the above equation becomes the impedance of a hypothetical line made up of the larger of the two conductors and Z_2 is made up of the smaller. The folded v-h-f unipole is an example where the transmission line is connected in series with the larger of the two conductors.

The conventional 3-wire match to give an impedance multiplication of 9 and the 5-wire match to give a ratio of approximately 25 are shown in figures 7C and 7D. The 4-wire match, not shown, will give an impedance transformation ratio of approximately 16.

The Delta Match and the T-Match The Delta match and the T-match are shown in figure 8. The delta match has been largely superseded by the newer T-match, however both these systems can be adjusted to give a low value of SWR on 50 to 600-ohm balanced transmission lines. In the case of the systems shown it will be necessary to make adjustments in the tapping distance along the driven radiator until minimum standing waves on the antenna transmission line are obtained. Since it is sometimes impracticable to eliminate completely the standing waves from the antenna transmission line when using these matching systems, it is common practice to cut the feed line, after standing waves have been reduced to a minimum, to a length which will give satisfactory loading of the transmitter over the desired frequency range of operation.

The inherent reactance of the T-match is tuned out by the use of two identical resonating capacitors in series with each leg of the T-rod. These capacitors should each have a maximum capacity of 8 $\mu\text{fd.}$ per meter of wavelength. Thus for 20 meters, each capacitor should have a maximum capacity of at least 160 $\mu\text{fd.}$ For power up to a kilowatt, 1000 volt spacing of the capacitors is adequate.

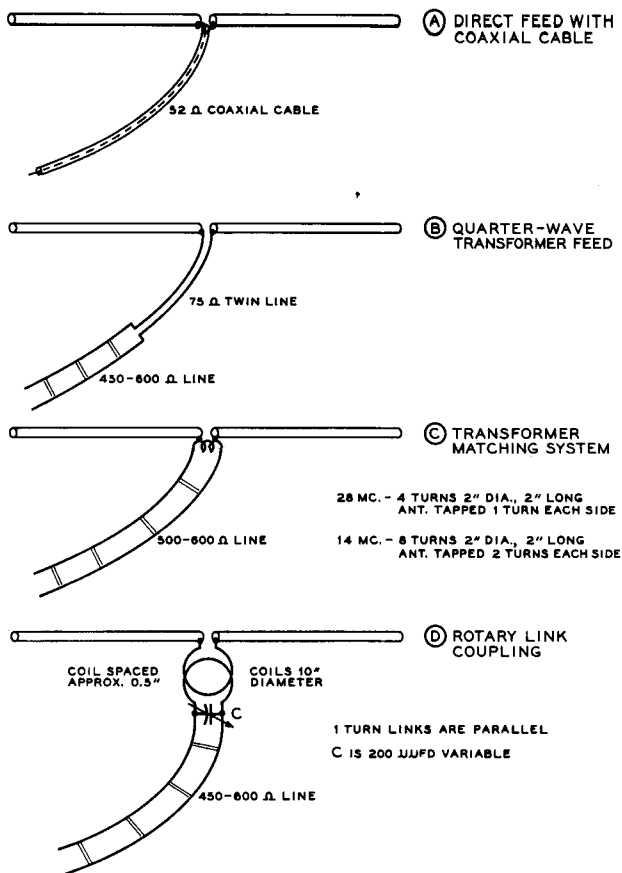

Figure 9
ALTERNATE FEED
METHODS WHERE THE
DRIVEN ELEMENT MAY
BE BROKEN IN THE
CENTER

These capacitors should be tuned for minimum SWR on the transmission line. The adjustment of these capacitors should be made at the same time the correct setting of the T-match rods is made as the two adjustments tend to be interlocking. The use of the standing wave meter (described in Test Equipment chapter) is recommended for making these adjustments to the T-match.

Feed Systems Using a Driven Element with Center Feed

Four methods of exciting the driven element of a parasitic array are shown in figure 9. The system shown at (A) has proven to be quite satisfactory in the case of an antenna-reflector two-element array or in the case of a three-element array with 0.2 to 0.25 wavelength spacing between the elements of the antenna system. The feed-point impedance of the center of the driven element is close enough to the characteristic impedance of the 52-ohm coaxial cable so that

the standing-wave ratio on the 52-ohm coaxial cable is less than 2-to-1. (B) shows an arrangement for feeding an array with a broken driven element from an open-wire line with the aid of a quarter-wave matching transformer. With 465-ohm line from the transmitter to the antenna this system will give a close match to a 12-ohm impedance at the center of the driven element. (C) shows an arrangement which uses an untuned transformer with lumped inductance for matching the transmission line to the center impedance of the driven element.

Rotary Link Coupling

In many cases it is desirable to be able to allow the antenna array to rotate continuously without regard to snarling of the feed line. If this is to be done some sort of slip rings or rotary joint must be made in the feed line. One relatively simple method of allowing unrestrained rotation of the antenna is to use the method of rotary link coupling shown in figure 9D. The two cou-

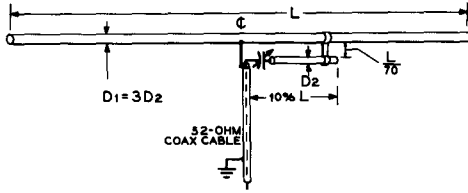

Figure 10

THE GAMMA MATCHING SYSTEM

See text for details of resonating capacitor

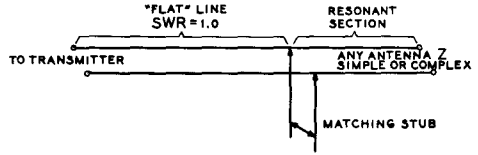

Figure 11

IMPEDANCE MATCHING WITH A CLOSED STUB ON A TWO WIRE TRANSMISSION LINE

pling rings are 10 inches in diameter and are usually constructed of 1/4-inch copper tubing supported one from the rotating structure and one from the fixed structure by means of stand-off insulators. The capacitor C in figure 9D is adjusted, after the antenna has been tuned, for minimum standing-wave ratio on the antenna transmission line. The dimensions shown will allow operation with either 14-Mc. or 28-Mc. elements, with appropriate adjustment of the capacitor C. The rings must of course be parallel and must lie in a plane normal to the axis of rotation of the rotating structure.

The Gamma Match The use of coaxial cable to feed the driven element of a yagi array is becoming increasingly popular. One reason for this increased popularity lies in the fact that the TVI-reduction problem is simplified when coaxial feed line is used from the transmitter to the antenna system. Radiation from the feed line is minimized when coaxial cable is used, since the outer conductor of the line may be grounded at several points throughout its length and since the intense field is entirely confined within the outer conductor of the coaxial cable. Other advantages of coaxial cable as the antenna feed line lie in the fact that coaxial cable may be run within the structure of a building without danger, or the cable may be run underground without disturbing its operation. Also, transmitting-type low-pass filters for 52 ohm impedance are more widely available and are less expensive than equivalent filters for two-wire line.

The gamma-match is illustrated in figure 10, and may be looked upon as one-half of a T-match. One resonating capacitor is used, placed in series with the gamma rod. The capacitor should have a capacity of 7 μfd . per meter of wavelength. For 15-meter operation the capacitor should have a maximum capacity of 105 μfd . The length of the gamma rod determines the impedance transformation between

the transmission line and the driven element of the array, and the gamma capacitor tunes out the inductance of the gamma rod. By adjustment of the length of the gamma rod, and the setting of the gamma capacitor, the SWR on the coaxial line may be brought to a very low value at the chosen operating frequency. The use of an Antennascope, described in the Test Equipment chapter is recommended for precise adjustment of the gamma match.

The Matching Stub If an open-wire line is used to feed a low impedance radiator, a section of the transmission line may be employed as a matching stub as shown in figure 11. The matching stub can transform any complex impedance to the characteristic impedance of the transmission line. While it is possible to obtain a perfect match and good performance with either an open stub or a shorted one by observing appropriate dimensions, a shorted stub is much more readily adjusted. Therefore, the following discussion will be confined to the problem of using a closed stub to match a low impedance load to a high impedance transmission line.

If the transmission line is so elevated that adjustment of a "fundamental" shorted stub cannot be accomplished easily from the ground, then the stub length may be increased by exactly one or two electrical half wavelengths, without appreciably affecting its operation.

While the correct position of the shorting bar and the point of attachment of the stub to the line can be determined entirely by experimental methods, the fact that the two adjustments are interdependent or interlocking makes such a cut-and-try procedure a tedious one. Much time can be saved by determining the approximate adjustments required by reference to a chart such as figure 12 and using them as a starter. Usually only a slight "touching up" will produce a perfect match and flat line.

In order to utilize figure 12, it is first necessary to locate accurately a voltage node or current node on the line in the vicinity that

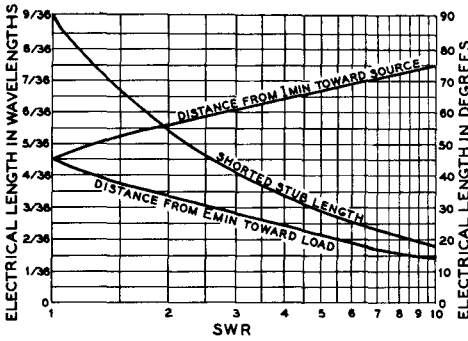

Figure 12
SHORTED STUB LENGTH AND POSITION CHART

From the standing wave ratio and current or voltage null position it is possible to determine the theoretically correct length and position of a shorted stub. In actual practice a slight discrepancy usually will be found between the theoretical and the experimentally optimized dimensions; therefore it may be necessary to "touch up" the dimensions after using the above data as a starting point.

has been decided upon for the stub, and also to determine the SWR.

Stub adjustment becomes more critical as the SWR increases, and under conditions of high SWR the current and voltage nulls are more sharply defined than the current and voltage maxima, or loops. Therefore, it is best to locate either a current null or voltage null, depending upon whether a current indicating device or a voltage indicating device is used to check the standing wave pattern.

The SWR is determined by means of a "directional coupler," or by noting the ratio of E_{max} to E_{min} or I_{max} to I_{min} as read on an indicating device.

It is assumed that the characteristic impedance of the section of line used as a stub is the same as that of the transmission line proper. It is preferable to have the stub section identical to the line physically as well as electrically.

25-5 Unidirectional Driven Arrays

Three types of unidirectional driven arrays are illustrated in figure 13. The array shown in figure 13A is an end-fire system which may

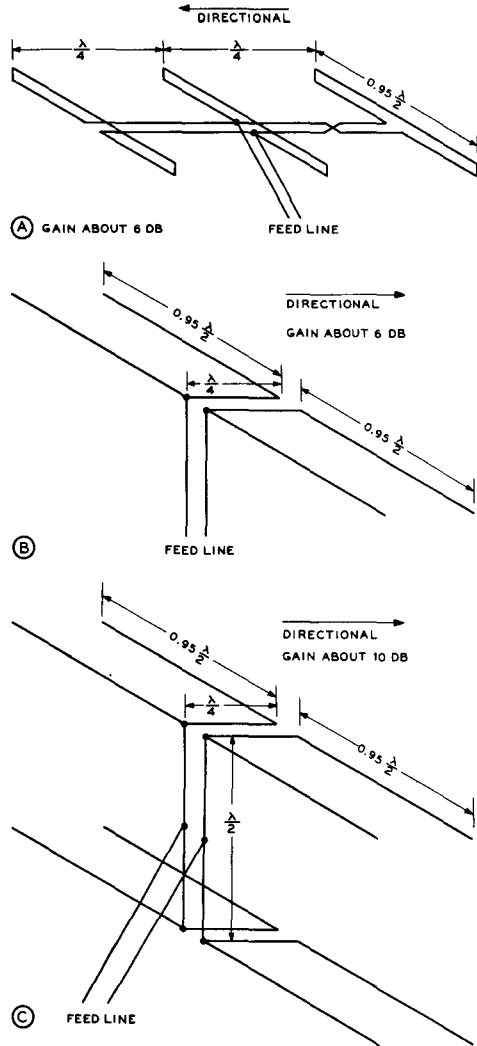

Figure 13
UNIDIRECTIONAL ALL-DRIVEN ARRAYS

A unidirectional all-driven end-fire array is shown at (A). (B) shows an array with two half waves in phase with driven reflectors. A Lazy-H array with driven reflectors is shown at (C). Note that the directivity is through the elements with the greatest total feed-line length in arrays such as shown at (B) and (C).

be used in place of a parasitic array of similar dimensions when greater frequency coverage than is available with the yagi type is desired. Figure 13B is a combination end-fire and co-

linear system which will give approximately the same gain as the system of figure 13A, but which requires less boom length and greater total element length. Figure 13C illustrates the familiar lazy-H with driven reflectors (or directors, depending upon the point of view) in a combination which will show wide bandwidth with a considerable amount of forward gain and good front-to-back ratio over the entire frequency coverage.

Unidirectional Stacked Broadside Arrays Three practicable types of unidirectional stacked broadside arrays are shown in figure 14. The first type, shown at figure 14A, is the simple "lazy H" type of antenna with parasitic reflectors for each element. (B) shows a simpler antenna array with a pair of folded dipoles spaced one-half wave vertically, operating with reflectors. In figure 14C is shown a more complex array with six half waves and six reflectors which will give a very worthwhile amount of gain.

In all three of the antenna arrays shown the spacing between the driven elements and the reflectors has been shown as one-quarter wavelength. This has been done to eliminate the requirement for tuning of the reflector, as a result of the fact that a half-wave element spaced exactly one-quarter wave from a driven element will make a unidirectional array when both elements are the same length. Using this procedure will give a gain of 3 db with the reflectors over the gain without the reflectors, with only a moderate decrease in the radiation resistance of the driven element. Actually, the radiation resistance of a half-wave dipole goes down from 73 ohms to 60 ohms when an identical half-wave element is placed one-quarter wave behind it.

A very slight increase in gain for the entire array (about 1 db) may be obtained at the expense of lowered radiation resistance, the necessity for tuning the reflectors, and decreased bandwidth by placing the reflectors 0.15 wavelength behind the driven elements and making them somewhat longer than the driven elements. The radiation resistance of each element will drop approximately to one-half the value obtained with untuned half-wave reflectors spaced one-quarter wave behind the driven elements.

Antenna arrays of the type shown in figure 14 require the use of some sort of lattice work for the supporting structure since the arrays occupy appreciable distance in space in all three planes.

Feed Methods The requirements for the feed systems for antenna arrays of the type shown in figure 14 are less critical than those for the close-spaced parasitic arrays shown in the previous section. This is a

natural result of the fact that a larger number of the radiating elements are directly fed with energy, and of the fact that the effective radiation resistance of each of the driven elements of the array is much higher than the feed-point resistance of a parasitic array. As a consequence of this fact, arrays of the type shown in figure 14 can be expected to cover a somewhat greater frequency band for a specified value of standing-wave ratio than the parasitic type of array.

In most cases a simple open-wire line may be coupled to the feed point of the array without any matching system. The standing-wave ratio with such a system of feed will often be less than 2-to-1. However, if a more accurate match between the antenna transmission line and the array is desired a conventional quarter-wave stub, or a quarter-wave matching transformer of appropriate impedance, may be used to obtain a low standing-wave ratio.

25-6 Bi-Directional Rotatable Arrays

The bi-directional type of array is sometimes used on the 28-Mc. and 50-Mc. bands where signals are likely to be coming from only one general direction at a time. Hence the sacrifice of discrimination against signals arriving from the opposite direction is likely to be of little disadvantage. Figure 15 shows two general types of bi-directional arrays. The flat-top beam, which has been described in detail earlier, is well adapted to installation atop a rotating structure. When self-supporting elements are used in the flat-top beam the problem of losses due to insulators at the ends of the elements is somewhat reduced. With a single-section flat-top beam a gain of approximately 4 db can be expected, and with two sections a gain of approximately 6 db can be obtained.

Another type of bi-directional array which has seen less use than it deserves is shown in figure 15B. This type of antenna system has a relatively broad azimuth or horizontal beam, being capable of receiving signals with little diminution in strength over approximately 40°, but it has a quite sharp elevation pattern since substantially all radiation is concentrated at the lower angles of radiation if more than a total of four elements is used in the antenna system. Figure 15B gives the approximate gain over a half-wave dipole at the height of the center of the array which can be expected. Also shown in this figure is a type of "rotating mast" structure which is well suited to rotation of this type of array.

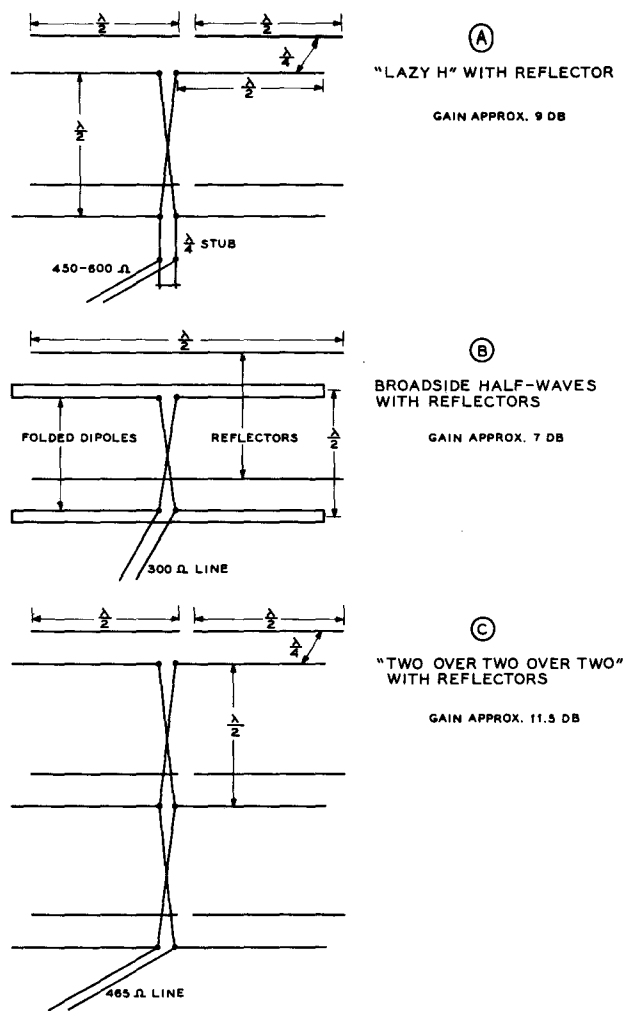

Figure 14
BROADSIDE ARRAYS WITH PARASITIC REFLECTORS

The apparent gain of the arrays illustrated will be greater than the values given due to concentration of the radiated signal at the lower elevation angles.

If six or more elements are used in the type of array shown in figure 15B no matching section will be required between the antenna transmission line and the feed point of the antenna. When only four elements are used the antenna is the familiar "lazy H" and a quarter-wave stub should be used for feeding from the antenna transmission line to the feed point of the antenna system.

If desired, and if mechanical considerations permit, the gain of the arrays shown in figure 15B may be increased by 3 db by placing a half-wave reflector behind each of the elements at a spacing of one-quarter wave. The array then becomes essentially the same as that shown in figure 14C and the same considerations in regard to reflector spacing and

tuning will apply. However, the factor that a bi-directional array need be rotated through an angle of less than 180° should be considered in this connection.

25-7 Construction of Rotatable Arrays

A considerable amount of ingenuity may be exercised in the construction of the supporting structure for a rotatable array. Every person has his own ideas as to the best method of construction. Often the most practicable method of construction will be dictated by the

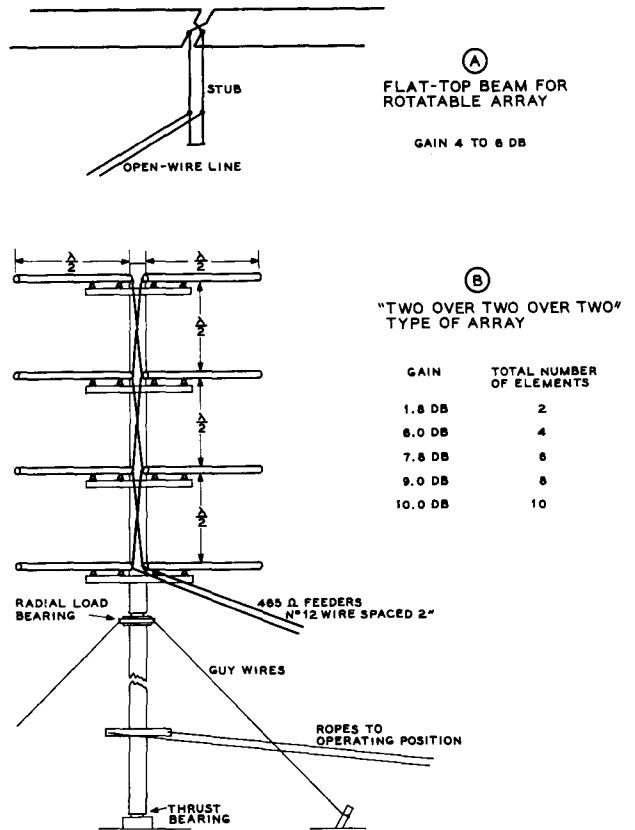

Figure 15
TWO GENERAL TYPES
OF BI-DIRECTIONAL
ARRAYS

Average gain figures are given for both the flat-top beam type of array and for the broadside-colinear array with different numbers of elements.

availability of certain types of constructional materials. But in any event be sure that sound mechanical engineering principles are used in the design of the supporting structure. There are few things quite as discouraging as the picking up of pieces, repairing of the roof, etc., when a newly constructed rotary comes down in the first strong wind. If the principles of mechanical engineering are understood it is wise to calculate the loads and torques which will exist in the various members of the structure with the highest wind velocity which may be expected in the locality of the installation. If this is not possible it will usually be worth the time and effort to look up a friend who understands these principles.

Radiating Elements One thing more or less standard about the construction of rotatable antenna arrays is the use of dural tubing for the self-supporting elements. Other materials may be used but an alloy known as

24ST has proven over a period of time to be quite satisfactory. Copper tubing is too heavy for a given strength, and steel tubing, unless copper plated, is likely to add an undesirably large loss resistance to the array. Also, steel tubing, even when plated, is not likely to withstand salt atmosphere such as encountered along the seashore for a satisfactory period of time. Do not use a soft aluminum alloy for the elements unless they will be quite short; 24ST is a hard alloy and is best although there are several other alloys ending in "ST" which will be found to be satisfactory. Do not use an alloy ending in "SO" or "S" in a position in the array where structural strength is important, since these letters designate a metal which has not been heat treated for strength and rigidity. However, these softer alloys, and aluminum electrical conduit, may be used for short radiating elements such as would be used for the 50-Mc. band or as interconnecting conductors in a stacked array.

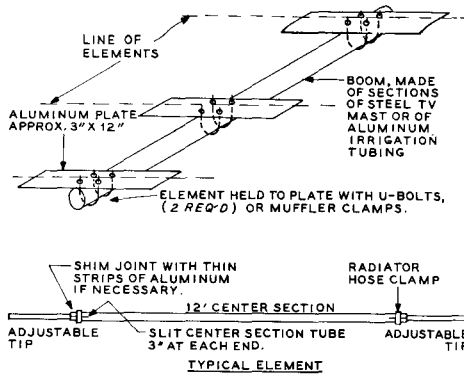

Figure 16

3-ELEMENT "PLUMBER'S DELIGHT" ANTENNA ARRAY

All-metal configuration permits rugged, light assembly. Joints are made with U-bolts and metal plates for maximum rigidity.

"Plumber's Delight" Construction

It is characteristic of the conventional type of multi-element parasitic array such as discussed previously and outlined that the centers of all the elements are at zero r-f potential with respect to ground. It is therefore possible to use a metallic structure without insulators for supporting the various elements of the array. A typical three element array of this type is shown in figure 16. In this particular array, U-bolts and metal plates have been employed to fasten the elements to the boom. The elements are made of telescoping sections of aluminum tubing. The tips of the inner sections of tubing are split, and a tubing clamp is slipped over the joint, as shown in the drawing. Before assembly of the joint, the mating pieces of aluminum are given a thin coat of *Penetrox-A* compound. (This anti-oxidizing paste is manufactured by *Burdny Co.*, Norwalk, Conn. and is distributed by the *General Electric Supply Co.*) When the tubes are telescoped and the clamp is tightened, an air-tight seal is produced, reducing corrosion to a minimum.

The boom of the parasitic array may be made from two or three sections of steel TV mast, or it may be made of a single section of aluminum irrigation pipe. This pipe is made by *Reynolds Aluminum Co.*, and others, and may often be purchased via the *Sears, Roebuck Co.* mail-order department. Three inch pipe may be

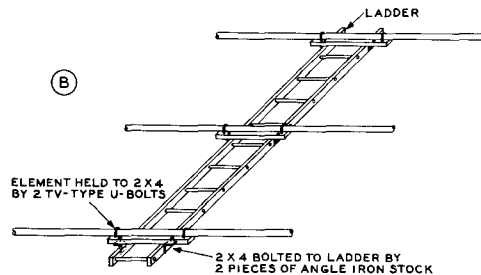
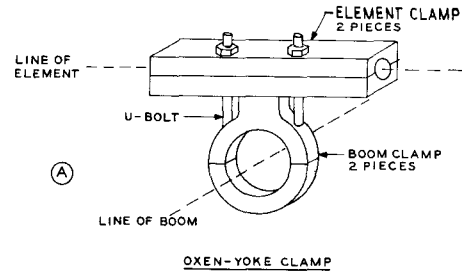

Figure 17

(A) OXEN-YOKE CLAMP IS DESIGNED FOR ALL METAL ASSEMBLY

(B) ALTERNATIVE WOODEN SUPPORTING ARRANGEMENT

A wooden ladder may be used to support a 10 or 15 meter array.

used for the 10 and 15 meter antennas, and the huskier four inch pipe should be used for a 20 meter beam.

Automobile muffler clamps can often be used to affix the elements to the support plates. Larger clamps of this type will fasten the plates to the boom. In most cases, the muffler clamps are untreated, and they should be given one or two coats of rust-proof paint to protect them from inclement weather. All bolts, nuts, and washers used in the assembly of the array should be of the plated variety to reduce corrosion and rust.

An alternative assembly is to employ the "Oxen Yoke" type of clamps, shown in figure 17. These light-weight aluminum fittings are obtainable from the *Continental Electronics and Sound Co.*, Dayton, 27, Ohio, and are available in a wide range of sizes.

If it is desired to use a split driven element for a balanced feed system, it is necessary to insulate the element from the supporting structure of the antenna. The element should be severed at the center, and the two halves

driven onto a wooden dowel, as shown in figure 17B. The element may then be mounted upon an aluminum support plate by means of four ceramic insulators. Metal based insulators, such as the *Johnson 135-67* are recommended, since the all-ceramic types may break at the mounting holes when the array is subjected to heavy winds.

25-8 Tuning the Array

Although satisfactory results may be obtained by pre-cutting the antenna array to the dimensions given earlier in this chapter, the occasion might arise when it is desired to make a check on the operation of the antenna before calling the job complete.

The process of tuning an array may fairly satisfactorily be divided into two more or less distinct steps: the actual tuning of the array for best front-to-back ratio or for maximum forward gain, and the project of obtaining the best possible impedance match between the antenna transmission line and the feed point of the array.

Tuning the Array Proper The actual tuning of the array for best front-to-back ratio or maximum forward gain may best be accomplished with the aid of a low-power transmitter feeding a dipole antenna (polarized the same as the array being tuned) at least four or five wavelengths away from the antenna being tuned and located at the same elevation as that of the antenna under test. A calibrated field-strength meter of the remote-indicating type is then coupled to the feed point of the antenna array being tuned. The transmissions from the portable transmitter should be made as short as possible and the call sign of the station making the test should be transmitted at least every ten minutes.

It is, of course, possible to tune an array with the receiver connected to it and with a station a mile or two away making transmissions on your request. But this method is more cumbersome and is not likely to give complete satisfaction. It is also possible to carry out the tuning process with the transmitter connected to the array and with the field-strength meter connected to the remote dipole antenna. In this event the indicating instrument of the remote-indicating field-strength meter should be visible from the position where the elements are being tuned. However, when the array is being tuned with the transmitter connected to it there is always the problem of making continual adjustments to the transmitter so that a constant amount of power will be fed to the array under test. Also, if you use this system,

use very low power (5 or 10 watts of power is usually sufficient) and make sure that the antenna transmission line is effectively grounded as far as d-c plate voltage is concerned. The use of the method described in the previous paragraph of course eliminates these problems.

One satisfactory method for tuning the array proper, assuming that it is a system with several parasitic elements, is to set the directors to the dimensions given in figure 5 and then to adjust the reflector for maximum forward signal. Then the first director should be varied in length until maximum forward signal is obtained, and so on if additional directors are used. Then the array may be reversed in direction and the reflector adjusted for best front-to-back ratio. Subsequent small adjustments may then be made in both the directors and the reflector for best forward signal with a reasonable ratio of front-to-back signal. The adjustments in the directors and the reflector will be found to be interdependent to a certain degree, but if small adjustments are made after the preliminary tuning process a satisfactory set of adjustments for maximum performance will be obtained. It is usually best to make the end sections of the elements smaller in diameter so that they will slip inside the larger tubing sections. The smaller sliding sections may be clamped inside the larger main sections.

In making the adjustments described, it is best to have the rectifying element of the remote-indicating field-strength meter directly at the feed point of the array, with a resistor at the feed point of the estimated value of feed-point impedance for the array.

Matching to the Antenna Transmission Line The problem of matching the impedance of the antenna transmission line to the array is much simplified if the pro-

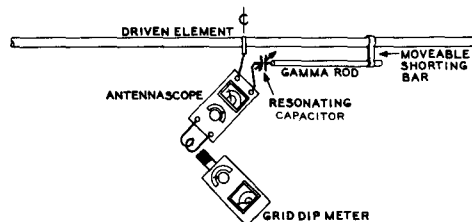
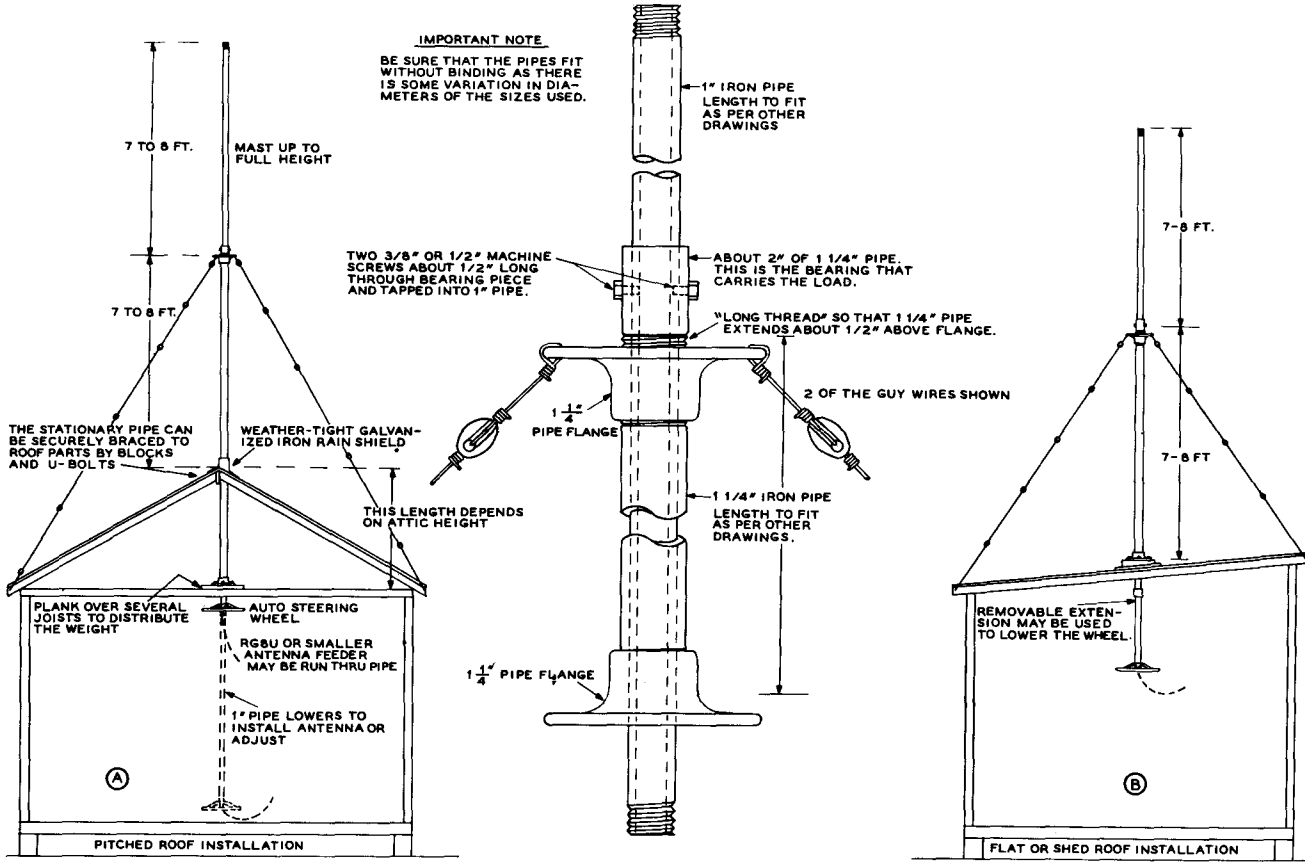

Figure 18
ADJUSTMENT OF GAMMA MATCH BY USE
OF ANTENNASCOPE AND GRID-DIP
METER



cess of tuning the array is made a substantially separate process as just described. After the tuning operation is complete, the resonant frequency of the driven element of the antenna should be checked, directly at the center of the driven element if practicable, with a grid-dip meter. It is important that the resonant frequency of the antenna be at the center of the frequency band to be covered. If the resonant frequency is found to be much different from the desired frequency, the length of the driven element of the array should be altered until this condition exists. A relatively small change in the length of the driven element will have only a second order effect on the tuning of the parasitic elements of the array. Hence, a moderate change in the length of the driven element may be made without repeating the tuning process for the parasitic elements.

When the resonant frequency of the antenna system is correct, the antenna transmission line, with impedance-matching device or network between the line and antenna feed point, is then attached to the array and coupled to a low-power exciter unit or transmitter. Then, preferably, a standing-wave meter is connected in series with the antenna transmission line at a point relatively much more close to the transmitter than to the antenna. However, for best indication there should be 10 to 15 feet of line between the transmitter and the standing-wave meter. If a standing-wave meter is not available the standing-wave ratio may be checked approximately by means of a neon lamp or a short fluorescent tube if twin transmission line is being used, or it may be checked with a thermomilliammeter and a loop, a neon lamp, or an r-f ammeter and a pair of clips spaced a fixed distance for clipping onto one wire of a two-wire open line.

If the standing-wave ratio is below 1.5 to 1

it is satisfactory to leave the installation as it is. If the ratio is greater than this range it will be best when twin line or coaxial line is being used, and advisable with open-wire line, to attempt to decrease the s.w.r.

It must be remembered that no adjustments made at the transmitter end of the transmission line will alter the SWR on the line. All adjustments to better the SWR must be made at the antenna end of the line and to the device which performs the impedance transformation necessary to match the characteristic impedance of the antenna to that of the transmission line.

Before any adjustments to the matching system are made, the resonant frequency of the driven element must be ascertained, as explained previously. If all adjustments to correct impedance mismatch are made at this frequency, the problem of reactance termination of the transmission line is eliminated, greatly simplifying the problem. The following steps should be taken to adjust the impedance transformation:

1. The output impedance of the matching device should be measured. An Antennascope and a grid-dip oscillator are required for this step. The Antennascope is connected to the output terminals of the matching device. If the driven element is a folded dipole, the Antennascope connects directly to the split section of the dipole. If a gamma match or T-match are used, the Antennascope connects to the transmission-line end of the device. If a Q-section is used, the Antennascope connects to the bottom end of the section. The grid-dip oscillator is coupled to the input terminals of the Antennascope as shown in figure 18.
2. The grid-dip oscillator is tuned to the resonant frequency of the antenna, which

Figure 19

ALL-PIPE ROTATING MAST STRUCTURE FOR ROOF INSTALLATION

An installation suitable for a building with a pitched roof is shown at (A). At (B) is shown a similar installation for a flat or shed roof. The arrangement as shown is strong enough to support a lightweight 3-element 28-Mc. array and a light 3-element 50-Mc. array above the 28-Mc. array on the end of a 4-foot length of 1/2-inch pipe.

The lengths of pipe shown were chosen so that when the system is in the lowered position one can stand on a household ladder and put the beam in position atop the rotating pipe. The lengths may safely be revised upward somewhat if the array is of a particularly lightweight design with low wind resistance.

Just before the mast is installed it is a good idea to give the rotating pipe a good smearing of cup grease or waterproof pump grease. To get the lip of the top of the stationary section of 1 1/4-inch pipe to project above the flange plate, it will be necessary to have a plumbing shop cut a slightly deeper thread inside the flange plate, as well as cutting an unusually long thread on the end of the 1 1/4-inch pipe. It is relatively easy to waterproof this assembly through the roof since the 1 1/4-inch pipe is stationary at all times. Be sure to use pipe compound on all the joints and then really tighten these joints with a pair of pipe wrenches.

has been determined previously, and the Antennascope control is turned for a null reading on the meter of the Antennascope. The impedance presented to the Antennascope by the matching device may be read directly on the calibrated dial of the Antennascope.

- Adjustments should be made to the matching device to present the desired impedance transformation to the Antennascope. If a folded dipole is used as the driven element, the transformation ratio of the dipole must be varied as explained previously in this chapter to provide a more exact match. If a T-match or gamma match system is used, the length of the matching rod may be changed to effect a proper match. If the Antennascope ohmic reading is *lower* than the desired reading, the length of the matching rod should be *increased*. If the Antennascope reading is *higher* than the desired reading, the length of the matching rod should be *decreased*. After each change in length of the matching rod, the series capacitor in the matching system should be re-resonated for best null on the meter of the Antennascope.

Raising and Lowering the Array A practical problem always present when tuning up and matching an array is the physical location of the structure. If the array is atop the mast it is inaccessible for adjustment, and if it is located on stepladders where it can be adjusted easily it cannot be rotated. One encouraging factor in this situation is the fact that experience has shown that if the array is placed 8 or 10 feet above ground on some stepladders for the preliminary tuning process, the raising of the system to its full height will not produce a serious change in the adjustments. So it is usually possible to make preliminary adjustments with the system located slightly greater than head height above ground, and then to raise the antenna to a position where it may be rotated for final adjustments. If the position of the sliding sections as determined near the ground is marked so that the adjustments will not be lost, the array may be raised to rotatable height and the fastening clamps left loose enough so that the elements may be slid in by means of a long bamboo pole. After a series of trials a satisfactory set of lengths can be obtained. But the end results usually come so close to the figures given in figure 5 that a subsequent array is usually cut to the dimensions given and installed as-is.

The matching process does not require rotation, but it does require that the antenna proper be located at as nearly its normal oper-

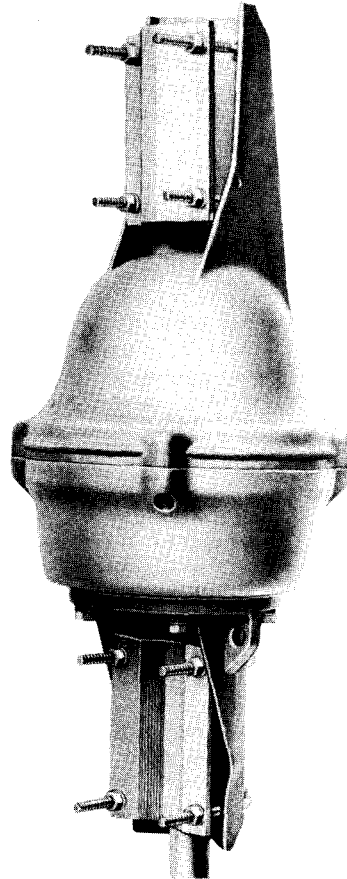

Figure 20
HEAVY DUTY ROTATOR SUITABLE
FOR AMATEUR BEAMS

The new Cornell-Dubilier type HAM-1 rotor has extra heavy motor and gearing system to withstand weight and inertia of amateur array under the buffeting of heavy winds. Steel spur gears and rotor lock prevent "pin-wheeling" of antenna.

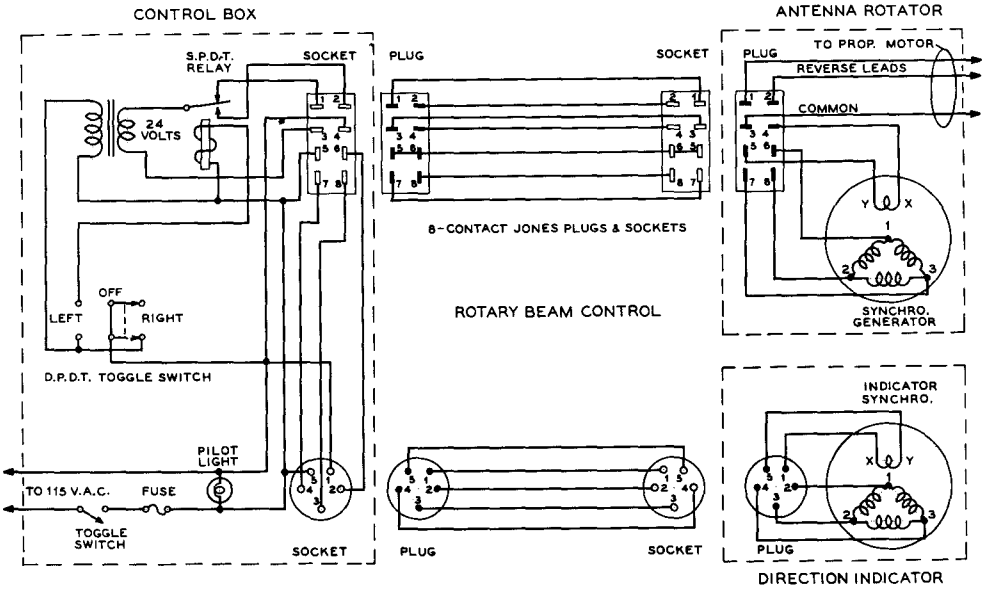

Figure 21

SCHMATIC OF A COMPLETE ANTENNA CONTROL SYSTEM

ating position as possible. However, on a particular installation the positions of the current minimums on the transmission line near the transmitter may be checked with the array in the air, and then the array may be lowered to ascertain whether or not the positions of these points have moved. If they have not, and in most cases if the feeder line is strung out back and forth well above ground as the antenna is lowered they will not change, the positions of the last few toward the antenna itself may be determined. Then the calculation of the matching quarter-wave section may be made, the section installed, the standing-wave ratio again checked, and the antenna re-installed in its final location.

25-9 Antenna Rotation Systems

Structures for the rotation of antenna arrays may be divided into two general classes: the rotating mast and the rotating platform. The rotating mast is especially suitable where the transmitting equipment is installed in the garage or some structure away from the main house. Such an installation is shown in figure 19. A very satisfactory rotation mechanism is obtained by the use of a large steering wheel

located on the bottom pipe of the rotating mast, with the thrust bearing for the structure located above the roof.

If the rotating mast is located a distance from the operating position, a system of pulleys and drive rope may be used to turn the antenna, or a slow speed electric motor may be employed.

The rotating platform system is best if a tower or telephone pole is to be used for antenna support. A number of excellent rotating platform devices are available on the market for varying prices. The larger and more expensive rotating devices are suitable for the rotation of a rather sizeable array for the 14-Mc. band while the smaller structures, such as those designed for rotating a TV antenna are designed for less load and should be used only with a 28-Mc. or 50-Mc. array. Most common practice is to install the rotating device atop a platform built at the top of a telephone pole or on the top of a lattice mast of sizeable cross section so that the mast will be self-supporting and capable of withstanding the torque imposed upon it by the rotating platform.

A heavy duty TV rotator may be employed for rotation of 6 and 10-meter arrays. Fifteen and twenty meter arrays should use rotators designed for amateur use such as the *Cornell-Dubilier HAM-1* unit shown in figure 20.

25-10 Indication of Direction

The most satisfactory method for indicating the direction of transmission of a rotatable array is that which uses Selsyns or synchros for the transmission of the data from the rotating structure to the indicating pointer at the operating position. A number of synchros and Selsyns of various types are available on the surplus market. Some of them are designed for operation on 115 volts at 60 cycles, some are designed for operation on 60 cycles but at a lowered voltage, and some are designed for operation from 400-cycle or 800-cycle energy. This latter type of high-frequency synchro is the most generally available type, and the high-frequency units are smaller and lighter than the 60-cycle units. Since the indicating synchro must deliver an almost negligible amount of power to the pointer which it drives, the high-frequency types will operate quite satisfactorily from 60-cycle power if the voltage on them is reduced to somewhere between 6.3 and 20 volts. In the case of many of the units available, a connection sheet is provided along with a recommendation in regard to the operating voltage when they are run on 60 cycles. In any event the operating voltage should be held as low as it may be and still give satisfactory transmission of data from the antenna to the operating position. Certainly it should not be necessary to run such a voltage on the units that they become overheated.

A suitable Selsyn indicating system is shown in figure 21.

Systems using a potentiometer capable of continuous rotation and a milliammeter, along with a battery or other source of direct current, may also be used for the indication of direction. A commercially-available potentiometer (Ohmite RB-2) may be used in conjunction with a 0-1 d-c milliammeter having a hand-calibrated scale for direction indication.

25-11 "Three-Band" Beams

A popular form of beam antenna introduced during the past few years is the so-called *three-band beam*. An array of this type is designed to operate on three adjacent amateur bands, such as the ten, fifteen, and twenty meter group. The principle of operation of this form of antenna is to employ parallel tuned circuits placed at critical positions in the elements of the beam which serve to electrically connect and disconnect the outer sections of the elements as the frequency of excitation of the antenna is changed. A typical "three-band" element is shown in figure 22. At the lowest operating frequency, the tuned

traps exert a minimum influence upon the element and it resonates at a frequency determined by the electrical length of the configuration, plus a slight degree of loading contributed by the traps. At some higher frequency (generally about 1.5 times the lowest operating frequency) the outer set of traps are in a parallel resonant condition, placing a high impedance between the element and the tips beyond the traps. Thus, the element resonates at a frequency 1.5 times higher than that determined by the overall length of the element. As the frequency of operation is raised to approximately 2.0 times the lowest operating frequency, the inner set of traps become resonant, effectively disconnecting a larger portion of the element from the driven section. The length of the center section is resonant at the highest frequency of operation. The center section, plus the two adjacent inner sections are resonant at the intermediate frequency of operation, and the complete element is resonant at the lowest frequency of operation.

The efficiency of such a system is determined by the accuracy of tuning of both the element sections and the isolating traps. In addition the combined dielectric losses of the traps affect the overall antenna efficiency. As with all multi-purpose devices, some compromise between operating convenience and efficiency must be made with antennas designed to operate over more than one narrow band of frequencies. It is a tribute to the designers of the better multi-band beams that they perform as well as they do, taking into account the theoretical difficulties that must be overcome.

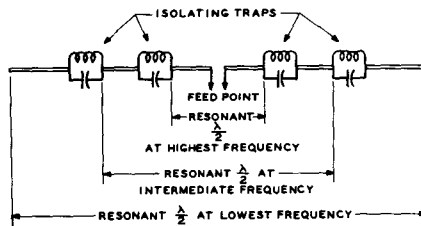

Figure 22
TRAP-TYPE "THREE BAND"
ELEMENT

Isolating traps permit dipole to be self-resonant at three widely different frequencies.

Mobile Equipment Design and Installation

Mobile operation is permitted on all amateur bands. Tremendous impetus to this phase of the hobby was given by the suitable design of compact mobile equipment. Complete mobile installations may be purchased as packaged units, or the whole mobile station may be home built, according to the whim of the operator.

The problems involved in achieving a satisfactory two-way installation vary somewhat with the band, but many of the problems are common to all bands. For instance, ignition noise is more troublesome on 10 meters than on 75 meters, but on the other hand an efficient antenna system is much more easily accomplished on 10 meters than on 75 meters. Also, obtaining a worthwhile amount of transmitter output without excessive battery drain is a problem on all bands.

26-1 Mobile Reception

When a broadcast receiver is in the car, the most practical receiving arrangement involves a converter feeding into the auto set. The advantages of good selectivity with good image rejection obtainable from a double conversion superheterodyne are achieved in most cases without excessive "birdie" troubles, a com-

mon difficulty with a double conversion superheterodyne constructed as an integral receiver in one cabinet. However, it is important that the b-c receiver employ an r-f stage in order to provide adequate isolation between the converter and the high frequency oscillator in the b-c receiver. The r-f stage also is desirable from the standpoint of image rejection if the converter does not employ a tuned output circuit (tuned to the frequency of the auto set, usually about 1500 kc.). A few of the late model auto receivers, even in the better makes, do not employ an r-f stage.

The usual procedure is to obtain converter plate voltage from the auto receiver. Experience has shown that if the converter does not draw more than about 15 or at most 20 ma. total plate current no damage to the auto set or loss in performance will occur other than a slight reduction in vibrator life. The converter drain can be minimized by avoiding a voltage regulator tube on the converter h-f oscillator. On 10 meters and lower frequencies it is possible to design an oscillator with sufficient stability so that no voltage regulator is required in the converter.

With some cars satisfactory 75-meter operation can be obtained without a noise clipper if resistor type spark plugs (such as those made by Autolite) are employed. However, a noise clipper is helpful if not absolutely neces-

sary, and it is recommended that a noise clipper be installed without confirming the necessity thereof. It has been found that quiet reception sometimes may be obtained on 75 meters simply by the use of resistor type plugs, but after a few thousand miles these plugs often become less effective and no longer do a fully adequate job. Also, a noise clipper insures against ignition noise from passing trucks and "un-suppressed" cars. On 10 meters a noise clipper is a "must" in any case.

Modifying the Auto Receiver There are certain things that should be done to the auto set when it is to be used with a converter, and they might as well be done all at the same time, because "dropping" an auto receiver and getting into the chassis to work on it takes quite a little time.

First, however, check the circuit of the auto receiver to see whether it is one of the few receivers which employ circuits which complicate connection of a noise clipper or a converter. If the receiver is yet to be purchased, it is well to investigate these points ahead of time.

If the receiver uses a negative B resistor strip for bias (as evidenced by the cathode of the audio output stage being grounded), then the additional plate current drain of the converter will upset the bias voltages on the various stages and probably cause trouble. Because the converter is not on all the time, it is not practical simply to alter the resistance of the bias strip, and major modification of the receiver probably will be required.

The best type of receiver for attachment of a converter and noise clipper uses an r-f stage; permeability tuning; single unit construction (except possibly for the speaker); push button tuning rather than a tuning motor; a high vacuum rectifier such as a 6X4 (rather than an 0Z4 or a synchronous rectifier); a 6SQ7 (or miniature or Loctal equivalent) with grounded cathode as second detector, first audio, and a.v.c.; power supply negative grounded directly (no common bias strip); a PM speaker (to minimize battery drain); and an internal r-f gain control (indicating plenty of built-in reserve gain which may be called upon if necessary). Many current model auto radios have all of the foregoing features, and numerous models have most of them, something to keep in mind if the set is yet to be purchased.

Noise Limiters A noise limiter either may be built into the set or purchased as a commercially manufactured unit for "out-board" connection via shielded wires. If the receiver employs a 6SQ7 (or Loctal or miniature equivalent) in a conventional circuit, it is a simple matter to build in a noise clipper by

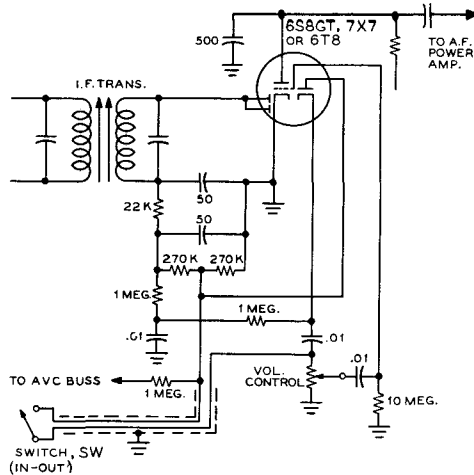

Figure 1
SERIES-GATE NOISE LIMITER FOR AUTO RECEIVER

Auto receivers using a 6SQ7, 7B6, 7X7, or 6AT6 as second detector and a.v.c. can be converted to the above circuit with but few wiring changes. The circuit has the advantage of not requiring an additional tube socket for the limiter diode.

substituting a 6S8 octal, 7X7 Loctal, or a 6T8 9-pin miniature as shown in figure 1. When substituting a 6T8 for a 6AT6 or similar 7-pin miniature, the socket must be changed to a 9-pin miniature type. This requires reaming the socket hole slightly.

If the receiver employs cathode bias on the 6SQ7 (or equivalent), and perhaps delayed a.v.c., the circuit usually can be changed to the grounded-cathode circuit of figure 1 without encountering trouble.

Some receivers take the r-f excitation for the a-v-c diode from the plate of the i-f stage. In this case, leave the a.v.c. alone and ignore the a-v-c buss connection shown in figure 1 (eliminating the 1-megohm decoupling resistor). If the set uses a separate a-v-c diode which receives r-f excitation via a small capacitor connected to the detector diode, then simply change the circuit to correspond to figure 1.

In case anyone might be considering the use of a crystal diode as a noise limiter in conjunction with the tube already in the set, it might be well to point out that crystal diodes perform quite poorly in series-gate noise clippers of the type shown.

It will be observed that no tone control is

shown. Multi-position tone controls tied in with the second detector circuit often permit excessive "leak through." Hence it is recommended that the tone control components be completely removed unless they are confined to the grid of the a-f output stage. If removed, the highs can be attenuated any desired amount by connecting a mica capacitor from plate to screen on the output stage. Ordinarily from .005 to .01 μfd . will provide a good compromise between fidelity and reduction of background hiss on weak signals.

Usually the switch SW will have to be mounted some distance from the noise limiter components. If the leads to the switch are over approximately $1\frac{1}{2}$ inches long, a piece of shield braid should be slipped over them and grounded. The same applies to the "hot" leads to the volume control if not already shielded. Closing the switch disables the limiter. This may be desirable for reducing distortion on broadcast reception or when checking the intensity of ignition noise to determine the effectiveness of suppression measures taken on the car. The switch also permits one to check the effectiveness of the noise clipper.

The 22,000-ohm decoupling resistor at the bottom end of the i-f transformer secondary is not critical, and if some other value already is incorporated inside the shield can it may be left alone so long as it is not over 47,000 ohms, a common value. Higher values must be replaced with a lower value even if it requires a can opener, because anything over 47,000 ohms will result in excessive loss in gain. There is some loss in a-f gain inherent in this type of limiter anyhow (slightly over 6 db), and it is important to minimize any additional loss.

It is important that the total amount of capacitance in the RC decoupling (r-f) filter not exceed about 100 $\mu\mu\text{fd}$. With a value much greater than this "pulse stretching" will occur and the effectiveness of the noise clipper will be reduced. Excessive capacitance will reduce the amplitude and increase the duration of the ignition pulses before they reach the clipper. The reduction in pulse amplitude accomplishes no good since the pulses are fed to the clipper anyhow, but the greater duration of the lengthened pulses increases the audibility and the blanking interval associated with each pulse. If a shielded wire to an external clipper is employed, the r-f by-pass on the "low" side of the RC filter may be eliminated since the capacitance of a few feet of shielded wire will accomplish the same result as the by-pass capacitor.

The switch SW is connected in such a manner that there is practically no change in gain with the limiter in or out. If the auto set does not have any reserve gain and more gain is

needed on weak broadcast signals, the switch can be connected from the hot side of the volume control to the junction of the 22,000, 270,000 and 1 megohm resistors instead of as shown. This will provide approximately 6 db more gain when the clipper is switched out.

Many late model receivers are provided with an internal r-f gain control in the cathode of the r-f and/or i-f stage. This control should be advanced full on to provide better noise limiter action and make up for the loss in audio gain introduced by the noise clipper.

Installation of the noise clipper often detunes the secondary of the last i-f transformer. This should be repeaked before the set is permanently replaced in the car unless the trimmer is accessible with the set mounted in place.

Additional clipper circuits will be found in the receiver chapter of this Handbook.

Selectivity While not of serious concern on 10 meters, the lack of selectivity exhibited by a typical auto receiver will result in QRM difficulty on 20 and 75 meters. A typical auto set has only two i-f transformers of relatively low-Q design, and the second one is loaded by the diode detector. The skirt selectivity often is so poor that a strong local will depress the a.v.c. when listening to a weak station as much as 15 kc. different in frequency.

One solution is to add an outboard i-f stage employing two good quality double-tuned transformers (not the midget variety) connected "back-to-back" through a small coupling capacitance. The amplifier tube (such as a 6BA6) should be biased to the point where the gain of the outboard unit is relatively small (1 or 2), assuming that the receiver already has adequate gain. If additional gain is needed, it may be provided by the outboard unit. Low-capacitance shielded cable should be used to couple into and out of the outboard unit, and the unit itself should be thoroughly shielded.

Such an outboard unit will sharpen the nose selectivity slightly and the skirt selectivity greatly. Operation then will be comparable to a home-station communications receiver, though selectivity will not be as good as a receiver employing a 50-kc. or 85-kc. "Q5'er."

Obtaining Power for the Converter While the set is on the bench for installation of the noise clipper, provision should be made for obtaining filament and plate voltage for the converter, and for the exciter and speech amplifier of the transmitter, if such an arrangement is to be used. To permit removal of either the converter or the auto set from the car without removing the other, a connector should be provided. The best method

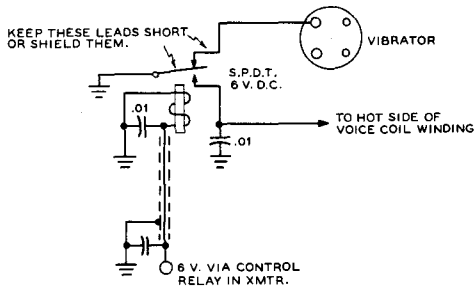

Figure 3

METHOD OF ELIMINATING THE BATTERY DRAIN OF THE RECEIVER VIBRATOR PACK DURING TRANSMISSION

If the receiver chassis has room for a mid-gate s.p.d.t. relay, the above arrangement not only silences the receiver on transmit but saves several amperes battery drain.

If the normally open contact on the relay is connected to the hot side of the voice coil winding as shown in figure 3 (assuming one side of the voice coil is grounded in accordance with usual practice), the receiver will be killed instantly when switching from receive to transmit, in spite of the fact that the power supply filter in the receiver takes a moment to discharge. However, if a "slow start" power supply (such as a dynamotor or a vibrator pack with a large filter) is used with the transmitter, shorting the voice coil probably will not be required.

Using the Receiver Plate Supply On Transmit An alternative and highly recommended procedure is to make use of the receiver B supply on transmit, instead of disabling it. One disadvantage of the popular PE-103A dynamotor is the fact that its 450-500 volt output is too high for the low power r-f and speech stages of the transmitter. Dropping this voltage to a more suitable value of approximately 250 volts by means of dropping resistors is wasteful of power, besides causing the plate voltage on the oscillator and any buffer stages to vary widely with tuning. By means of a mid-gate 6-volts.p.d.t. relay mounted in the receiver, connected as shown in figure 2, the B supply of the auto set is used to power the oscillator and other low power stages (and possibly screen voltage on the modulator). On transmit the B voltage is removed from the receiver and converter, automatically silencing the receiver. When switching to receive the trans-

mitter oscillator is killed instantly, thus avoiding trouble from dynamotor "carry over."

The efficiency of this arrangement is good because the current drain on the main high voltage supply for the modulated amplifier and modulator plate(s) is reduced by the amount of current borrowed from the receiver. At least 80 ma. can be drawn from practically all auto sets, at least for a short period, without damage.

It will be noted that with the arrangement of figure 2, plate voltage is supplied to the audio output stage at all times. However, when the screen voltage is removed, the plate current drops practically to zero.

The 200-ohm resistor in series with the normally open contact is to prevent excessive sparking when the contacts close. If the relay feeds directly into a filter choke or large capacitor there will be excessive sparking at the contacts. Even with the arrangement shown, there will be considerable sparking at the contacts; but relay contacts can stand such sparking quite a while, even on d.c., before becoming worn or pitted enough to require attention. The 200-ohm resistor also serves to increase the effectiveness of the .01- μ f. r-f by-pass capacitor.

Auxiliary Antenna Trimmer One other modification of the auto receiver which may or may not be desirable depending upon the circumstances is the addition of an auxiliary antenna trimmer capacitor.

If the converter uses an untuned output circuit and the antenna trimmer on the auto set is peaked with the converter cut in, then it is quite likely that the trimmer adjustment will not be optimum for broadcast-band reception when the converter is cut out. For reception of strong broadcast band signals this usually will not be serious, but where reception of weak broadcast signals is desired the loss in gain often cannot be tolerated, especially in view of the fact that the additional length of antenna cable required for the converter installation tends to reduce the strength of broadcast band signals.

If the converter has considerable reserve gain, it may be practicable to peak the antenna trimmer on the auto set for broadcast-band reception rather than resonating it to the converter output circuit. But oftentimes this results in insufficient converter gain, excessive image troubles from loud local amateur stations, or both.

The difficulty can be circumvented by incorporation of an auxiliary antenna trimmer connected from the "hot" antenna lead on the auto receiver to ground, with a switch in series for cutting it in or out. This capacitor and switch can be connected across either the

converter end or the set end of the cable between the converter and receiver. This auxiliary trimmer should have a range of about 3 to 50 $\mu\text{fd.}$, and may be of the inexpensive compression mica type.

With the trimmer cut out and the converter turned off (by-passed by the "in-out" switch), peak the regular antenna trimmer on the auto set at about 1400 kc. Then turn on the converter, with the receiver tuned to 1500 kc., switch in the auxiliary trimmer, and peak this trimmer for maximum background noise. The auxiliary trimmer then can be left switched in at all times except when receiving very weak broadcast band signals.

Some auto sets, particularly certain General Motors custom receivers, employ a high-Q high-impedance input circuit which is very critical as to antenna capacitance. Unless the shunt capacitance of the antenna (including cable) approximates that of the antenna installation for which the set was designed, the antenna trimmer on the auto set cannot be made to hit resonance with the converter cut out. This is particularly true when a long antenna cable is used to reach a whip mounted at the rear of the car. Usually the condition can be corrected by unsoldering the internal connection to the antenna terminal connector on the auto set and inserting in series a 100- $\mu\text{fd.}$ mica capacitor. Alternatively an adjustable trimmer covering at least 50 to 150 $\mu\text{fd.}$ may be substituted for the 100- $\mu\text{fd.}$ fixed capacitor. Then the adjustment of this trimmer and that of the regular antenna trimmer can be juggled back and forth until a condition is achieved where the input circuit of the auto set is resonant with the converter either in or out of the circuit. This will provide maximum gain and image rejection under all conditions of use.

Reducing Battery Drain of the Receiver When the receiving installation is used frequently, and particularly when the receiver is used with the car parked, it is desirable to keep the battery drain of the receiver-converter installation at an absolute minimum. A substantial reduction in drain can be made in many receivers, without appreciably affecting their performance. The saving of course depends upon the design of the particular receiver and upon how much trouble and expense one is willing to go to. Some receivers normally draw (without the converter connected) as much as 10 amperes. In many cases this can be cut to about 5 amperes by incorporating all practicable modifications. Each of the following modifications is applicable to many auto receivers.

If the receiver uses a speaker with a field coil, replace the speaker with an equivalent PM type.

Practically all 0.3-ampere r-f and a-f voltage amplifier tubes have 0.15-ampere equivalents. In many cases it is not even necessary to change the socket wiring. However, when substituting i-f tubes it is recommended that the i-f trimmer adjustments be checked. Generally speaking it is not wise to attempt to substitute for the converter tube or a-f power output tube.

If the a-f output tube employs conventional cathode bias, substitute a cathode resistor of twice the value originally employed, or add an identical resistor in series with the one already in the set. This will reduce the B drain of the receiver appreciably without seriously reducing the maximum undistorted output. Because the vibrator power supply is much less than 100 per cent efficient, a saving of one watt of B drain results in a saving of nearly 2 watts of battery drain. This also minimizes the overload on the B supply when the converter is switched in, assuming that the converter uses B voltage from the auto set.

If the receiver uses push-pull output and if one is willing to accept a slight reduction in the maximum volume obtainable without distortion, changing over to a single ended stage is simple if the receiver employs conventional cathode bias. Just pull out one tube, double the value of cathode bias resistance, and add a 25- $\mu\text{fd.}$ by-pass capacitor across the cathode resistor if not already by-passed. In some cases it may be possible to remove a phase inverter tube along with one of the a-f output tubes.

If the receiver uses a motor driven station selector with a control tube (d-c amplifier), usually the tube can be removed without upsetting the operation of the receiver. One then must of course use manual tuning.

While the changeover is somewhat expensive, the 0.6 ampere drawn by a 6X4 or 6X5 rectifier can be eliminated by substituting six 115-volt r-m-s 50-ma. selenium rectifiers (such as Federal type 402D3200). Three in series are substituted for each half of the full-wave rectifier tube. Be sure to observe the correct polarity. The selenium rectifiers also make a good substitution for an 0Z4 or 0Z4-GT which is causing hash difficulties when using the converter.

Offsetting the total cost of nearly \$4.00 is the fact that these rectifiers probably will last for the entire life of the auto set. Before purchasing the rectifiers, make sure that there is room available for mounting them. While these units are small, most of the newer auto sets employ very compact construction.

Two-Meter Reception For reception on the 144-Mc. amateur band, and those higher in frequency, the simple converter-

auto-set combination has not proven very satisfactory. The primary reason for this is the fact that the relatively sharp i-f channel of the auto set imposes too severe a limitation on the stability of the high-frequency oscillator in the converter. And if a crystal-controlled beating oscillator is used in the converter, only a portion of the band may be covered by tuning the auto set.

The most satisfactory arrangement has been found to consist of a separately mounted i.f., audio, and power supply system, with the converter mounted near the steering column. The i-f system should have a bandwidth of 30 to 100 kc. and may have a center frequency of 10.7 Mc. if standard i-f transformers are to be used. The control head may include the 144-Mc. r-f, mixer, and oscillator sections, and sometimes the first i-f stage. Alternatively, the control head may include only the h-f oscillator, with a broadband r-f unit included within the main receiver assembly along with the i.f. and audio system. Commercially manufactured kits and complete units using this general lineup are available.

An alternative arrangement is to build a converter, 10.7-Mc. i-f channel, and second detector unit, and then to operate this unit in conjunction with the auto-set power supply, audio system, and speaker. Such a system makes economical use of space and power drain, and can be switched to provide normal broadcast-band auto reception or reception through a converter for the h-f amateur bands.

A recent development has been the VHF transceiver, typified by the *Gonset Communicator*. Such a unit combines a crystal controlled transmitter and a tunable VHF receiver together with a common audio system and power supply. The complete VHF station may be packaged in a single cabinet. Various forms of VHF transceivers are shown in the construction chapters of this Handbook.

26-2 Mobile Transmitters

As in the case of transmitters for fixed-station operation, there are many schools of thought as to the type of transmitter which is most suitable for mobile operation. One school states that the mobile transmitter should have very low power drain, so that no modification of the electrical system of the automobile will be required, and so that the equipment may be operated without serious regard to discharging the battery when the car is stopped, or overloading the generator when the car is in mo-

tion. A total transmitter power drain of about 80 watts from the car battery (6 volts at 13 amperes, or 12 volts at 7 amperes) is about the maximum that can be allowed under these conditions. For maximum power efficiency it is recommended that a vibrator type of supply be used as opposed to a dynamotor supply, since the conversion efficiency of the vibrator unit is high compared to that of the dynamotor.

A second school of thought states that the mobile transmitter should be of relatively high power to overcome the poor efficiency of the usual mobile whip antenna. In this case, the mobile power should be drawn from a system that is independent from the electrical system of the automobile. A belt driven high voltage generator is often coupled to the automobile engine in this type of installation.

A variation of this idea is to employ a complete secondary power system in the car capable of providing 115 volts a.c. Shown in figure 4 is a *Leece-Neville* three phase alternator mounted atop the engine block, and driven with a fan belt. The voltage regulator and selenium rectifier for charging the car battery from the a-c system replace the usual d-c generator. These new items are mounted in the front of the car radiator. The alternator provides a balanced delta output circuit where in the line voltage is equal to the coil voltage, but the line current is $\sqrt{3}$ times the coil current. The coil voltage is a nominal 6-volts, RMS and three 6.3 volt 25 ampere filament transformers may be connected in delta on the primary and secondary windings to step the 6-volts up to three-phase 115-volts. If desired, a special 115-volt, 3-phase step-up transformer may be wound which will occupy less space than the three filament transformers. Since the ripple frequency of a three phase d-c power supply will be quite high, a single 10 mfd filter capacitor will suffice.

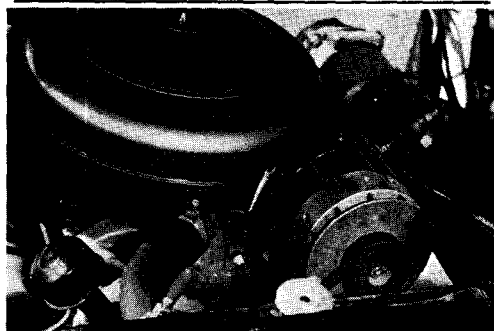

Figure 4
LEECE-NEVILLE 3-PHASE
ALTERNATOR IS ENGINE DRIVEN
BY AUXILIARY FAN BELT.

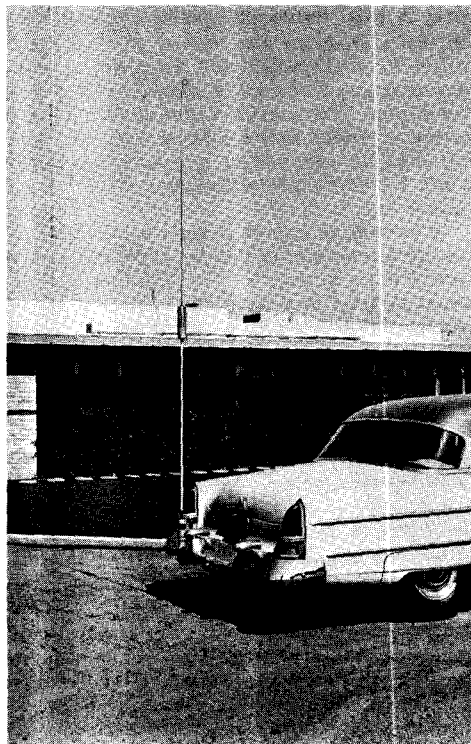

Figure 5

A CENTER LOADED 80-METER WHIP USING AIR WOUND COIL MAY BE USED WITH HIGH POWERED TRANSMITTERS

An anti-corona loop is placed at the top of the whip to reduce loss of power and burning of tip of antenna. Number of turns in coil is critical and adjustable, high-Q coil is recommended. Whip may be used over frequency range of about 15 kilocycles without retuning.

26-3

Antennas for Mobile Work

10-Meter Mobile Antennas

The most popular mobile antenna for 10-meter operation is a rear-mounted whip approximately 8 feet long, fed with coaxial line. This is a highly satisfactory antenna, but a few

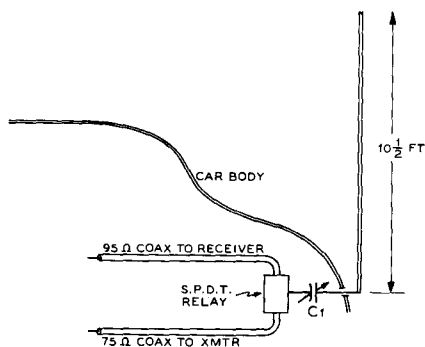

Figure 6

5/16-WAVE WHIP RADIATOR FOR 10 METERS

If a whip antenna is made slightly longer than one-quarter wave it acts as a slightly better radiator than the usual quarter-wave whip, and it can provide a better match to the antenna transmission line if the reactance is tuned out by a series capacitor close to the base of the antenna. Capacitor C_1 may be a 100- $\mu\mu\text{fd}$. midget variable.

remarks are in order on the subject of feed and coupling systems.

The feed point resistance of a resonant quarter-wave rear-mounted whip is approximately 20 to 25 ohms. While the standing-wave ratio when using 50-ohm coaxial line will not be much greater than 2 to 1, it is nevertheless desirable to make the line to the transmitter exactly one quarter wavelength long electrically at the center of the band. This procedure will minimize variations in loading over the band. The physical length of RG-8/U cable, from antenna base to antenna coupling coil, should be approximately 5 feet 3 inches. The antenna changeover relay preferably should be located either at the antenna end or the transmitter end of the line, but if it is more convenient physically the line may be broken anywhere for insertion of the relay.

If the same rear-mounted whip is used for broadcast-band reception, attenuation of broadcast-band signals by the high shunt capacitance of the low impedance feed line can be reduced by locating the changeover relay right at the antenna lead in, and by running 95-ohm coax (instead of 50 or 75 ohm coax) from the relay to the converter. Ordinarily this will produce negligible effect upon the operation of the converter, but usually will make a worthwhile improvement in the strength of broadcast-band signals.

A more effective radiator and a better line match may be obtained by making the whip approximately $10\frac{1}{2}$ feet long and feeding it with 75-ohm coax (such as RG-11/U) via a series capacitor, as shown in figure 6. The relay and series capacitor are mounted inside the trunk, as close to the antenna feedthrough or base-mount insulator as possible. The $10\frac{1}{2}$ -foot length applies to the overall length from the tip of the whip to the point where the lead in passes through the car body. The leads inside the car (connecting the coaxial cable, relay, series capacitor and antenna lead) should be as short as possible. The outer conductor of both coaxial cables should be grounded to the car body at the relay end with short, heavy conductors.

A 100- μ fd. midget variable capacitor is suitable for C_1 . The optimum setting should be determined experimentally at the center of the band. This setting then will be satisfactory over the whole band.

One suitable coupling arrangement for either a $\frac{1}{4}$ -wave or $5/16$ -wave whip on 10 meters is to use a conventional tank circuit, inductively coupled to a "variable link" coupling loop which feeds the coaxial line. Alternatively, a pi-network output circuit may be used. If the input impedance of the line is very low and the tank circuit has a low C/L ratio, it may be necessary to resonate the coupling loop with series capacitance in order to obtain sufficient coupling. This condition often is encountered with a $\frac{1}{4}$ -wave whip when the line length approximates an electrical half wavelength.

If an all-band center-loaded mobile antenna is used, the loading coil at the center of the antenna may be shorted out for operation of the antenna on the 10-meter band. The usual type of center-loaded mobile antenna will be between 9 and 11 feet long, including the center-loading inductance which is shorted out. Hence such an antenna may be shortened to an electrical quarter-wave for the 10-meter band by using a series capacitor as just discussed. Alternatively, if a pi-network is used in the plate circuit of the output stage of the mobile transmitter, any reactance presented at the antenna terminals of the transmitter by the antenna may be tuned out with the pi-network.

The All-Band Center-Loaded Mobile Antenna

The great majority of mobile operation on the 14-Mc. band and below is with center loaded whip antennas. These antennas use an insulated bumper or body mount, with provision for coaxial feed from the base of the antenna to the transmitter, as shown in figure 7.

The center-loaded whip antenna must be

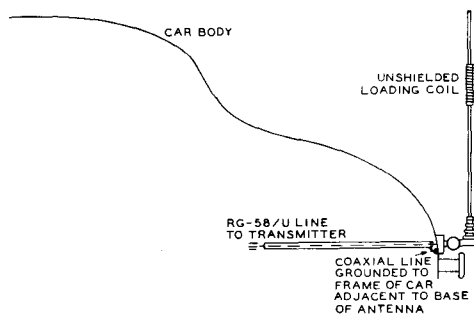

Figure 7

THE CENTER-LOADED WHIP ANTENNA

The center-loaded whip antenna, when provided with a tapped loading coil or a series of coils, may be used over a wide frequency range. The loading coil may be shorted for use of the antenna on the 10-meter band.

tuned to obtain optimum operation on the desired frequency of operation. These antennas will operate at maximum efficiency over a range of perhaps 20 kc. on the 75-meter band, covering a somewhat wider range on the 40-meter band, and covering the whole 20-meter phone band. The procedure for tuning the antennas is discussed in the instruction sheet which is furnished with them, but basically the procedure is as follows:

The antenna is installed, fully assembled, with a coaxial lead of RG-58/U from the base of the antenna to the place where the transmitter is installed. The rear deck of the car should be closed, and the car should be parked in a location as clear as possible of trees, buildings, and overhead power lines. Objects within 15 or 20 feet of the antenna can exert a considerable detuning effect on the antenna system due to its relatively high operating Q. The end of the coaxial cable which will plug into the transmitter is terminated in a link of 3 or 4 turns of wire. This link is then coupled to a grid-dip meter and the resonant frequency of the antenna determined by noting the frequency at which the grid current fluctuates. The coils furnished with the antennas normally are too large for the usual operating frequency, since it is much easier to remove turns than to add them. Turns then are removed, *one at a time*, until the antenna resonates at the desired frequency. If too many turns have been removed, a length of wire may be spliced on and soldered. Then, with a length of insulating tubing slipped over the soldered joint, turns may be added to lower the resonant fre-

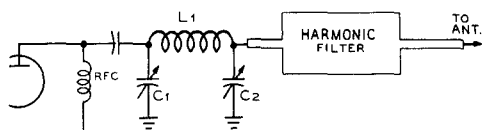

Figure 8

PI-NETWORK ANTENNA COUPLER

The pi-network antenna coupler is particularly satisfactory for mobile work since the coupler affords some degree of harmonic reduction, provides a coupling variation to meet varying load conditions caused by frequency changes, and can cancel out reactance presented to the transmitter at the end of the antenna transmission line.

For use of the coupler on the 3.9-Mc. band C_1 should have a maximum capacitance of about 250 $\mu\text{mfd.}$, L_1 should be about 9 microhenrys (30 turns 1" dia. by 2" long), and C_2 may include a fixed and a variable element with maximum capacitance of about 1400 $\mu\text{mfd.}$ A 100- $\mu\text{mfd.}$ variable capacitor will be suitable at C_1 for the 14-Mc. and 28-Mc. bands, with a 350- $\mu\text{mfd.}$ variable at C_2 . Inductor L_1 should have an inductance of about 2 microhenrys (11 turns 1" dia. by 1" long) for the 14-Mc. band, and about 0.8 microhenry (6 turns 1" dia. by 1" long) for the 28-Mc. band.

quency. Or, if the tapped type of coil is used, taps are changed until the proper number of turns for the desired operating frequency is found. This procedure is repeated for the different bands of operation.

Feeding the Center-Loaded Antenna

After much experimenting it has been found that the most satisfactory method for feeding the coaxial line to the base of a center-loaded antenna is with the pi-network coupler. Figure 8 shows the basic arrangement, with recommended circuit constants. It will be noted that relatively large values of capacitance are required for all bands of operation, with values which seem particularly large for the 75-meter band. But reference to the discussion of pi-network tank circuits in Chapter 13 will show that the values suggested are normal for the values of impedance, impedance transformation, and operating Q which are encountered in a mobile installation of the usual type.

26-4

Construction and Installation of Mobile Equipment

It is recommended that the following measures be taken when constructing mobile equipment, either transmitting or receiving, to ensure trouble-free operation over long periods:

Use only a stiff, heavy chassis unless the chassis is quite small.

Use lock washers or lock nuts when mounting components by means of screws.

Use stranded hook-up wire except where r-f considerations make it inadvisable (such as for instance the plate tank circuit leads in a v-h-f amplifier). Lace and tie leads wherever necessary to keep them from vibrating or flopping around.

Unless provided with gear drive, tuning capacitors in the large sizes will require a rotor lock.

Filamentary (quick heating) tubes should be mounted only in a vertical position.

The larger size carbon resistors and mica capacitors should not be supported from tube socket pins, particularly from miniature sockets. Use tie points and keep the resistor and capacitor "pigtailed" short.

Generally speaking, rubber shock mounts are unnecessary or even undesirable with passenger car installations, or at least with full size passenger cars. The springing is sufficiently "soft" that well constructed radio equipment can be bolted directly to the vehicle without damage from shock or vibration. Unless shock mounting is properly engineered as to the stiffness and placement of the shock mounts, mechanical-resonance "amplification" effects may actually cause the equipment to be shaken more than if the equipment were bolted directly to the vehicle.

Surplus military equipment provided with shock or vibration mounts was intended for use in aircraft, jeeps, tanks, gun-firing Naval craft, small boats, and similar vehicles and craft subject to severe shock and vibration. Also, the shock mounting of such equipment is very carefully engineered in order to avoid harmful resonances.

To facilitate servicing of mobile equipment, all interconnecting cables between units should be provided with separable connectors on at least one end.

Control Circuits The send-receive circuits of a mobile installation are dictated by the design of the equipment, and therefore will be left to the ingenuity of the reader. However, a few generalizations and suggestions are in order.

Do not attempt to control too many relays, particularly heavy duty relays with large coils, by means of an ordinary push-to-talk switch on a microphone. These contacts are not designed for heavy work, and the inductive kick when the contacts on the microphone switch are designed to handle. It is better to actuate a single relay with the push-to-talk switch and then control all other relays, including the heavy duty contactor for the dynamotor or vibrator pack, with this relay.

The procedure of operating only one relay directly by the push-to-talk switch, with all other relays being controlled by this control relay, will eliminate the often-encountered difficulty where the shutting down of one item of equipment will *close* relays in other items as a result of the coils of relays being placed in series with each other and with heater circuits. A recommended general control circuit, where one side of the main control relay is connected to the hot 6-volt circuit, but all other relays have one side connected to ground, is illustrated in figure 9. An additional advantage of such a circuit is that only one control wire need be run to the coil of each additional relay, the other side of the relay coils being grounded.

The heavy-duty 6-volt solenoid-type contactor relays such as provided on the PE-103A and used for automobile starter relays usually draw from 1.5 to 2 amperes. While somewhat more expensive, heavy-duty 6-volt relays of conventional design, capable of breaking 30 amperes at 6 volts d.c., are available with coils drawing less than 0.5 ampere.

When purchasing relays keep in mind that the current rating of the contacts is not a fixed value, but depends upon (1) the voltage, (2) whether it is a.c. or d.c., and (3) whether the circuit is purely resistive or is inductive. If in doubt, refer to the manufacturer's recommendations. Also keep in mind that a dynamotor presents almost a dead short until the armature starts turning, and the starting relay should be rated at considerably more than the normal dynamotor current.

Microphones and Circuits The most generally used microphone for mobile work is the single-button carbon. With a high-output-type microphone and a high-ratio microphone transformer, it is possible when "close talking" to drive even a pair of push-pull 6L6's without resorting to a speech amplifier. However, there is a wide difference in the output of the various type single button microphones, and a wide difference in the amount of step up obtained with different type microphone transformers. So at least one speech stage usually is desirable.

One of the most satisfactory single button

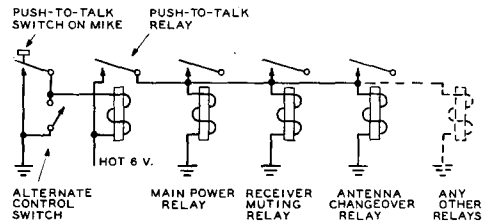

Figure 9

RELAY CONTROL CIRCUIT

Simplified schematic of the recommended relay control circuit for mobile transmitters. The relatively small push-to-talk relay is controlled by the button on the microphone or the communications switch. Then one of the contacts on this relay controls the other relays of the transmitter; one side of the coil of all the additional relays controlled should be grounded.

microphones is the standard Western Electric type F-1 unit (or Automatic Electric Co. equivalent). This microphone has very high output when operated at 6 volts, and good fidelity on speech. When used without a speech amplifier stage the microphone transformer should have a 50-ohm primary (rather than 200 or 500 ohms) and a secondary of at least 150,000 ohms and preferably 250,000 ohms.

The widely available surplus type T-17 microphone has higher resistance (200 to 500 ohms) and lower output, and usually will require a stage of speech amplification except when used with a very low power modulator stage.

Unless an F-1 unit is used in a standard housing, making contact to the button presents somewhat of a problem. No serious damage will result from soldering to the button if the connection is made to one edge and the soldering is done very rapidly with but a small amount of solder, so as to avoid heating the whole button.

A sound-powered type microphone removed from one of the chest sets available in the surplus market will deliver almost as much voltage to the grid of a modulator stage when used with a high-ratio microphone transformer as will an F-1 unit, and has the advantage of not requiring button current or a "hash filter." This is simply a dynamic microphone designed for high output rather than maximum fidelity.

The standardized connections for a single-button carbon microphone provided with push-to-talk switch are shown in figure 10. Practically all hand-held military-type single-button

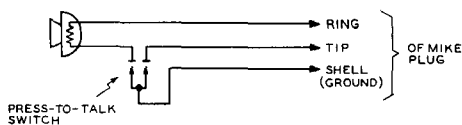

Figure 10

**STANDARD CONNECTIONS FOR THE
PUSH-TO-TALK SWITCH ON A HAND-
HELD SINGLE-BUTTON CARBON
MICROPHONE**

microphones on the surplus market use these connections.

There is an increasing tendency among mobile operators toward the use of microphones having better frequency and distortion characteristics than the standard single-button type. The high-impedance dynamic type is probably the most popular, with the *ceramic*-crystal type next in popularity. The conventional crystal type is not suitable for mobile use since the crystal unit will be destroyed by the high temperatures which can be reached in a closed car parked in the sun in the summer time.

The use of low-level microphones in mobile service requires careful attention to the elimination of common-ground circuits in the microphone lead. The ground connection for the shielded cable which runs from the transmitter to the microphone should be made at only one point, preferably directly adjacent to the grid of the first tube in the speech amplifier. The use of a low-level microphone usually will require the addition of two speech stages (a pentode and a triode), but these stages will take only a milliampere or two of plate current, and 150 ma. per tube of heater current.

PE-103A Dyna- Because of its availability
motor Power Unit on the surplus market at a low price and its suitability for use with about as powerful a mobile transmitter as can be employed in a passenger car without resorting to auxiliary batteries or a special generator, the PE-103A is probably the most widely used dynamotor for amateur work. Therefore some useful information will be given on this unit.

The nominal rating of the unit is 500 volts and 160 ma., but the output voltage will of course vary with load and is slightly higher with the generator charging. Actually the 160 ma. rating is conservative, and about 275 ma. can be drawn intermittently without overheating, and without damage or excessive brush or commutator wear. At this current the unit should not be run for more than 10 minutes at

a time, and the average "on" time should not be more than half the average "off" time.

The output voltage vs. current drain is shown approximately in figure 11. The exact voltage will depend somewhat upon the loss resistance of the primary connecting cable and whether or not the battery is on charge. The primary current drain of the dynamotor proper (excluding relays) is approximately 16 amperes at 100 ma., 21 amperes at 160 ma., 26 amperes at 200 ma., and 31 amperes at 250 ma.

Only a few of the components in the base are absolutely necessary in an amateur mobile installation, and some of them can just as well be made an integral part of the transmitter if desired. The base can be removed for salvage components and hardware, or the dynamotor may be purchased without base.

To remove the base proceed as follows: Loosen the four thumb screws on the base plate and remove the cover. Remove the four screws holding the dynamotor to the base plate. Trace the four wires coming out of the dynamotor to their terminals and free the lugs. Then these four wires can be pulled through the two rubber grommets in the base plate when the dynamotor is separated from the base plate. It may be necessary to bend the eyelets in the large lugs in order to force them through the grommets.

Next remove the two end housings on the dynamotor. Each is held with two screws. The high-voltage commutator is easily identified by its narrower segments and larger diameter. Next to it is the 12-volt commutator. The 6-volt commutator is at the other end of the armature. The 12-volt brushes should be removed when only 6-volt operation is planned, in order to reduce the drag.

If the dynamotor portion of the PE-103A power unit is a Pioneer type VS-25 or a Russell type 530- (most of them are), the wires to the 12-volt brush holder terminals can be cross connected to the 6-volt brush holder terminals with heavy jumper wires. One of the wires disconnected from the 12-volt brush terminals is the primary 12-volt pigtail and will come free. The other wire should be connected to the opposite terminal to form one of the jumpers.

With this arrangement it is necessary only to remove the 6-volt brushes and replace the 12-volt brushes in case the 6-volt commutator becomes excessively dirty or worn or starts throwing solder. No difference in output voltage will be noted, but as the 12-volt brushes are not as heavy as the 6-volt brushes it is not permissible to draw more than about 150 ma. except for emergency use until the 6-volt commutator can be turned down or repaired.

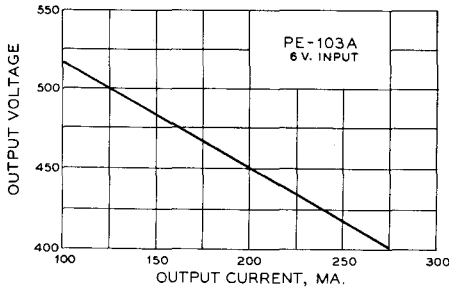

Figure 11
APPROXIMATE OUTPUT VOLTAGE VS.
LOAD CURRENT FOR A PE-103A
DYNAMOTOR

At 150 ma. or less the 12-volt brushes will last almost as long as the 6-volt brushes.

The reason that these particular dynamotors can be operated in this fashion is that there are two 6-volt windings on the armature, and for 12-volt operation the two are used in series with both commutators working. The arrangement described above simply substitutes for the regular 6-volt winding the winding and commutator which ordinarily came into operation only on 12-volt operation. Some operators have reported that the regulation of the PE-103A may be improved by operating both commutators in parallel with the 6-volt line.

The three wires now coming out of the dynamotor are identified as follows: The smaller wire is the positive high voltage. The heavy wire leaving the same grommet is positive 6 volts and negative high voltage. The single heavy wire leaving the other grommet is negative 6 volts. Whether the car is positive or negative ground, negative high voltage can be taken as car-frame ground. With the negative of the car battery grounded, the plate current can return through the car battery and the armature winding. This simply puts the 6 volts in series with the 500 volts and gives 6 extra volts plate voltage.

The trunk of a car gets very warm in summer, and if the transmitter and dynamotor are mounted in the trunk it is recommended that the end housings be left off the dynamotor to facilitate cooling. This is especially important in hot climates if the dynamotor is to be loaded to more than 200 ma.

When replacing brushes on a PE-103A check to see if the brushes are marked negative and positive. If so, be sure to install them accordingly, because they are not of the same material. The dynamotor will be marked to show which holder is negative.

When using a PE-103A, or any dynamotor for that matter, it may be necessary to devote one set of contacts on one of the control relays to breaking the plate or screen voltage to the transmitter oscillator. If these are supplied by the dynamotor, because the output of a dynamotor takes a moment to fall to zero when the primary power is removed.

26-5 Vehicular Noise Suppression

Satisfactory reception on frequencies above the broadcast band usually requires greater attention to noise suppression measures. The required measures vary with the particular vehicle and the frequency range involved.

Most of the various types of noise that may be present in a vehicle may be broken down into the following main categories:

- (1) Ignition noise.
- (2) Wheel static (tire static, brake static, and intermittent ground via front wheel bearings).
- (3) "Hash" from voltage regulator contacts.
- (4) "Whine" from generator commutator segment make and break.
- (5) Static from scraping connections between various parts of the car.

There is no need to suppress ignition noise completely, because at the higher frequencies ignition noise from passing vehicles makes the use of a noise limiter mandatory anyway. However, the limiter should not be given too much work to do, because at high engine speeds a noisy ignition system will tend to mask weak signals, even though with the limiter working, ignition "pops" may appear to be completely eliminated.

Another reason for good ignition suppression at the source is that strong ignition pulses contain enough energy when integrated to block the a-v-c circuit of the receiver, causing the gain to drop whenever the engine is speeded up. Since the a-v-c circuits of the receiver obtain no benefit from a noise clipper, it is important that ignition noise be suppressed enough at the source that the a-v-c circuits will not be affected even when the engine is running at high speed.

Ignition Noise The following procedure should be found adequate for reducing the ignition noise of practically any passenger car to a level which the clipper can handle satisfactorily at any engine speed at any frequency from 500 kc. to 148 Mc. Some

of the measures may already have been taken when the auto receiver was installed.

First either install a spark plug suppressor on each plug, or else substitute Autolite resistor plugs. The latter are more effective than suppressors, and on some cars ignition noise is reduced to a satisfactory level simply by installing them. However, they may not do an adequate job alone after they have been in use for a while, and it is a good idea to take the following additional measures.

Check all high tension connections for gaps, particularly the "pinch fit" terminal connectors widely used. Replace old high tension wiring that may have become leaky.

Check to see if any of the high tension wiring is cabled with low tension wiring, or run in the same conduit. If so, reroute the low tension wiring to provide as much separation as practicable.

By-pass to ground the 6-volt wire from the ignition coil to the ignition switch at each end with a 0.1- μ fd. molded case paper capacitor in parallel with a .001- μ fd. mica or ceramic, using the shortest possible leads.

Check to see that the hood makes a good ground contact to the car body at several points. Special grounding contactors are available for attachment to the hood lacing on cars that otherwise would present a grounding problem.

If the high-tension coil is mounted on the dash, it may be necessary to shield the high tension wire as far as the bulkhead, unless it already is shielded with armored conduit.

Wheel Static Wheel static is either static electricity generated by rotation of the tires and brake drums, or is noise generated by poor contact between the front wheels and the axles (due to the grease in the bearings). The latter type of noise seldom is caused by the rear wheels, but tire static may of course be generated by all four tires.

Wheel static can be eliminated by insertion of grounding springs under the front hub caps, and by inserting "tire powder" in all inner tubes. Both items are available at radio parts stores and from most auto radio dealers.

Voltage Regulator Hash Certain voltage regulators generate an objectionable amount of "hash" at the higher frequencies, particularly in the v-h-f range. A large by-pass will affect the operation of the regulator and possibly damage the points. A small by-pass can be used, however, without causing trouble. At frequencies above the frequency at which the hash becomes objectionable (approximately 20 Mc. or so) a small by-pass is quite effective. A 0.001- μ fd.

mica capacitor placed from the field terminal of the regulator to ground with the shortest possible leads often will produce sufficient improvement. If not, a choke consisting of about 60 turns of no. 18 d.c.c. or bell wire wound on a $\frac{3}{4}$ -inch form can be added. This should be placed right at the regulator terminal, and the 0.001- μ fd. by-pass placed from the generator side of the choke to ground.

Generator Whine Generator "whine" often can be satisfactorily suppressed from 550 kc. to 148 Mc. simply by by-passing the armature terminal to ground with a special "auto radio" by-pass of 0.25 or 0.5 μ fd. in parallel with a 0.001- μ fd. mica or ceramic capacitor. The former usually is placed on the generator when an auto radio is installed, but must be augmented by a mica or ceramic capacitor with short leads in order to be effective at the higher frequencies as well as on the broadcast band.

When more drastic measures are required, special filters can be obtained which are designed for the purpose. These are recommended for stubborn cases when a wide frequency range is involved. For reception only over a comparatively narrow band of frequencies, such as the 10-meter amateur band, a highly effective filter can be improvised by connecting between the previously described parallel by-pass capacitors and the generator armature terminal a resonant choke. This may consist of no. 10 enamelled wire wound on a suitable form and shunted with an adjustable trimmer capacitor to permit resonating the combination to the center of the frequency band involved. For the 10-meter band 11 turns close wound on a one-inch form and shunted by a 3-30 μ fd. compression-type mica trimmer is suitable. The trimmer should be adjusted experimentally at the center frequency.

When generator whine shows up after once being satisfactorily suppressed, the condition of the brushes and commutator should be checked. Unless a by-pass capacitor has opened up, excessive whine usually indicates that the brushes or commutator are in need of attention in order to prevent damage to the generator.

Body Static Loose linkages or body or frame joints anywhere in the car are potential static producers when the car is in motion, particularly over a rough road. Locating the source of such noise is difficult, and the simplest procedure is to give the car a thorough tightening up in the hope that the offending poor contacts will be caught by the procedure. The use of braided bonding straps between the various sections of the body of the car also may prove helpful.

Miscellaneous There are several other potential noise sources on a passenger vehicle, but they do not necessarily give trouble and therefore require attention only in some cases.

The heat, oil pressure, and gas gauges can cause a rasping or scraping noise. The gas gauge is the most likely offender. It will cause trouble only when the car is rocked or is in motion. The gauge units and panel indicators should both be by-passed with the 0.1- μ fd. paper and 0.001- μ fd. mica or ceramic combination previously described.

At high car speeds under certain atmospheric conditions corona static may be encountered unless means are taken to prevent it. The receiving-type auto whips which employ a plastic ball tip are so provided in order to minimize this type of noise, which is simply a discharge of the frictional static built up on the car. A whip which ends in a relatively sharp metal point makes an ideal discharge point for the static charge, and will cause corona trouble at a much lower voltage than if the tip were hooded with insulation. A piece of Vinylite sleeving slipped over the top portion of the whip and wrapped tightly with heavy thread will prevent this type of static discharge under practically all conditions. An alternative arrangement is to wrap the top portion of the whip with *Scotch* brand *electrical* tape.

Generally speaking it is undesirable from the standpoint of engine performance to use both spark-plug suppressors *and* a distributor suppressor. Unless the distributor rotor clearance is excessive, noise caused by sparking of the distributor rotor will not be so bad but what it can be handled satisfactorily by a noise limiter. If not, it is preferable to shield the hot lead between ignition coil and distributor rather than use a distributor suppressor.

In many cases the control rods, speedometer cable, etc., will pick up high-tension noise under the hood and conduct it up under the dash where it causes trouble. If so, all control rods and cables should be bonded to the fire wall (bulkhead) where they pass through, using a short piece of heavy flexible braid of the type used for shielding.

In some cases it may be necessary to bond the engine to the frame at each rubber engine mount in a similar manner. If a rear mounted whip is employed the exhaust tail pipe also should be bonded to the frame if supported by rubber mounts.

Locating Noise Sources Determining the source of certain types of noise is made difficult when several things are contributing to the noise, because elimination of one source often will make little or no apparent difference in the total noise. The following procedure will help to isolate and identify various types of noise.

Ignition noise will be present only when the ignition is on, even though the engine is turning over.

Generator noise will be present when the motor is turning over, regardless of whether the ignition switch is on. Slipping the drive belt off will kill it.

Gauge noise usually will be present only when the ignition switch is on or in the "left" position provided on some cars.

Wheel static when present will persist when the car clutch is disengaged and the ignition switch turned off (or to the left position), with the car coasting.

Body noise will be noticeably worse on a bumpy road than on a smooth road, particularly at low speeds.

Receivers and Transceivers

Receiver construction has just about become a lost art. Excellent general coverage receivers are available on the market in many price ranges. However, even the most modest of these receivers is relatively expensive, and most of the receivers are designed as a compromise—they must suit the majority of users, and they must be designed with an eye to the price.

It is a tribute to the receiver manufacturers that they have done as well as they have. Even so, the c-w man must often pay for a high-fidelity audio system and S-meter he never uses, and the phone man must pay for the c-w man's crystal filter. For one amateur, the receiver has too much bandspread; for the next, too little. For economy's sake and for ease

of alignment, low-Q coils are often found in the r-f circuits of commercial receivers, making the set a victim of cross-talk and overloading from strong local signals. Rarely does the purchaser of a commercial receiver realize that he could achieve the results he desires in a home-built receiver if he left off the frills and trivia which he does not need but which he must pay for when he buys a commercial product.

The ardent experimenter, however, needs no such arguments. He builds his receiver merely for the love of the game, and the thrill of using a product of his own creation.

It is hoped that the receiving equipment to be described in this chapter will awaken the

FIGURE 1
COMPONENT NOMENCLATURE

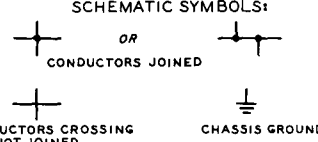
CAPACITORS:		RESISTORS:	
1- VALUES BELOW 999 μF FD ARE INDICATED IN UNITS. <i>EXAMPLE:</i> 150 μF FD DESIGNATED AS 150.	2- VALUES ABOVE 999 μF FD ARE INDICATED IN DECIMALS. <i>EXAMPLE:</i> .005 μF FD DESIGNATED AS .005.	3- OTHER CAPACITOR VALUES ARE AS STATED. <i>EXAMPLE:</i> 10 μF D, 0.5 μF FD, ETC.	4- TYPE OF CAPACITOR IS INDICATED BENEATH THE VALUE DESIGNATION. SM = SILVER MICA C = CERAMIC M = MICA P = PAPER
<i>EXAMPLE:</i> $\frac{250}{C}, \frac{.01}{P}, \frac{.001}{M}$		5- VOLTAGE RATING OF ELECTROLYTIC OR "FILTER" CAPACITOR IS INDICATED BELOW CAPACITY DESIGNATION. <i>EXAMPLE:</i> $\frac{10}{450}, \frac{20}{800}, \frac{.25}{10}$	6- THE CURVED LINE IN CAPACITOR SYMBOL REPRESENTS THE OUTSIDE FOIL "GROUND" OF PAPER CAPACITORS, THE NEGATIVE ELECTRODE OF ELECTROLYTIC CAPACITORS, OR THE ROTOR OF VARIABLE CAPACITORS.
		1- RESISTANCE VALUES ARE STATED IN OHMS, THOUSANDS OF OHMS (K), AND MEGOHMS (M). <i>EXAMPLE:</i> 270 OHMS = 270 4700 OHMS = 4.7 K 33000 OHMS = 33 K 100,000 OHMS = 100 K OR 0.1 M 33,000,000 OHMS = 33 M	
		2- ALL RESISTORS ARE 1-WATT COMPOSITION TYPE UNLESS OTHERWISE NOTED. WATTAGE NOTATION IS THEN INDICATED BELOW RESISTANCE VALUE. <i>EXAMPLE:</i> $\frac{47K}{0.5}$	
		INDUCTORS: MICROHENRIES = JH MILLIHENRIES = MH HENRIES = H	
		SCHEMATIC SYMBOLS:  CONDUCTORS JOINED CONDUCTORS CROSSING BUT NOT JOINED CHASSIS GROUND	

experimenter's instinct, even in those individuals owning expensive commercial receivers. These lucky persons have the advantage of comparing their home-built product against the best the commercial market has to offer. Some-

times such a comparison is surprising.

When the builder has finished the wiring of a receiver it is suggested that he check his wiring and connections carefully for possible errors before any voltages are applied to the

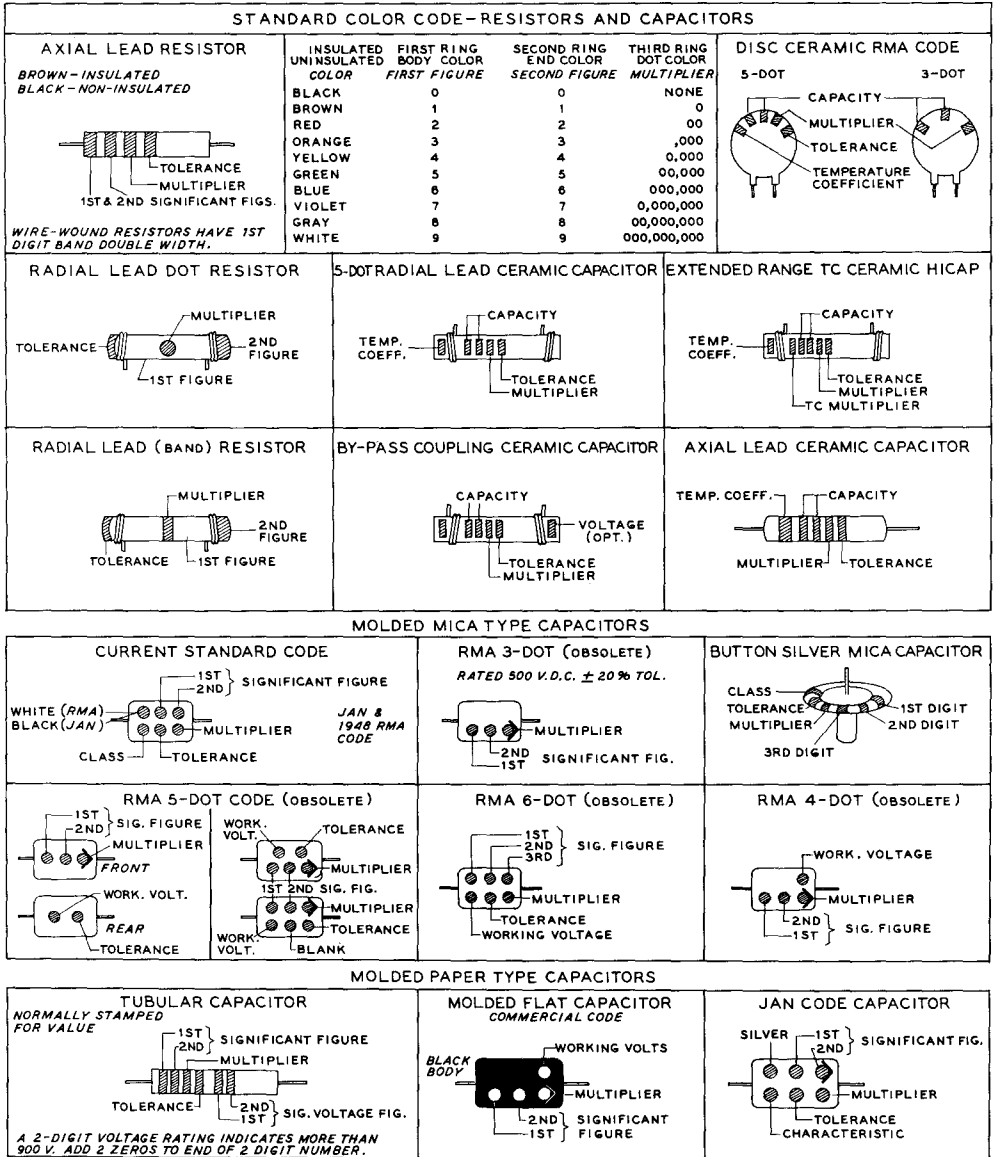

Figure 2

STANDARD COLOR CODE FOR RESISTORS AND CAPACITORS

The standard color code provides the necessary information required to properly identify color coded resistors and capacitors. Refer to the color code for numerical values and the number of zeros (or multiplier) assigned to the colors used. A fourth color band on resistors determines the tolerance rating as follows: Gold=5%, silver=10%. Absence of the fourth band indicates a 20% tolerance rating. Tolerance rating of capacitors is determined by the color code. For example: Red=2%, green=5%, etc. The voltage rating of capacitors is obtained by multiplying the color value by 100. For example: Orange=3 × 100, or 300 volts.

of building and operating their own receiving and transmitting equipment.

The Transceiver A popular item of equipment on "five meters" during the late "thirties," the *transceiver* is making a comeback today complete with modern tubes and circuitry. In brief, the transceiver is a packaged radio station combining the elements of the receiver and transmitter into a single unit having a common power supply and audio system. The present trend toward compact equipment and the continued growth of single sideband techniques combine naturally with the space-saving economies of the transceiver. Various transceiver circuits for the higher frequency amateur bands are shown in this chapter. The experimenter can start from these simple circuits and using modern miniature tubes and components can design and build his complete station in a cabinet no larger than a pre-war receiver.

27-1 Circuitry and Components

It is the practice of the editors of this Handbook to place as much usable information in the schematic illustration as possible. In order to simplify the drawing the component nomenclature of figure 1 is used in all the following construction chapters.

The electrical value of many small circuit components such as resistors and capacitors is often indicated by a series of colored bands

or spots placed on the body of the component. Several color codes have been used in the past, and are being used in modified form in the present to indicate component values. The most important of these color codes are illustrated in figure 2. Other radio components such as power transformers, i-f transformers, chokes, etc. have their leads color-coded for easy identification as tabulated in figure 3.

27-2 A Simple Transistorized Portable B-C Receiver

Illustrated in figures 4, 5, and 6 is an easy to construct two transistor portable broadcast receiver that is an excellent circuit for the beginner to build. The receiver covers the range of 500 kc. to 1500 kc. and needs no external antenna when used close to a high power broadcasting station. An external antenna may be added for more distant reception. The receiver is powered from a single 9-volt miniature transistor battery and delivers good speaker volume, yet draws a minimum of current permitting good battery life.

Circuit Description Operation of the receiver may be understood by referring to the schematic diagram of figure 5. The tuned circuit L-C resonates at the frequency of the broadcasting station. A portion of the r-f energy is applied to the base of the 2N112 p-n-p type transistor. A tapped

Figure 6
INTERIOR VIEW
OF TRANSISTOR
RECEIVER

The speaker and output transformer are mounted at the left of the Masonite chassis. Top, center is the "loopstick" r-f coil, and directly to the right is the 10 millihenry r-f choke in the collector lead of the 2N112 transistor. Battery is at lower right.

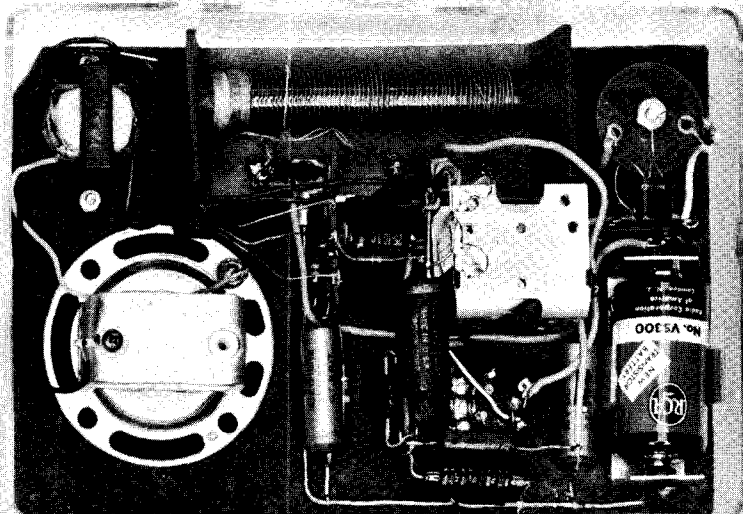

winding is placed on coil L_1 to achieve an impedance match to the low base impedance of the transistor. Emitter bias is used on this stage, and the amplified signal is capacity-coupled from the collector circuit to a 1N34 diode rectifier. The rectifier audio signal is recovered across the 2K diode load resistor, which takes the form of the audio volume control of the receiver. The diode operates in an untuned circuit, the selectivity of the receiver being determined by the tuned circuit in the r-f amplifier stage.

The audio signal taken from the arm of the volume control (R_1) is applied to the base of the 2N112 r-f amplifier which functions simultaneously as an audio amplifier stage. The amplified audio signal is recovered across the 2K collector load resistor of the 2N112, and is capacitively coupled to the base of a 2N217 p-n-p audio transistor. This stage is base and emitter biased, having the output transformer in the collector circuit. Optimum collector load for the 2N217 is approximately 500 ohms, and the 2N217 develops a maximum audio signal of 75 milliwatts at this load impedance. Transformer T_1 matches the transistor circuit to the 12 ohm miniature loudspeaker. The receiver draws a maximum signal current of 11 milliamperes from the 9-volt battery supply.

Receiver

Construction

The complete receiver is mounted upon a thin *Masonite* board measuring $7\frac{3}{8}$ " x $4\frac{7}{8}$ " in size. The board fits within a small plastic box having a hinged lid and handle. The dimensions of the box are $7\frac{1}{2}$ " x 5" x $1\frac{3}{8}$ ", exclusive of the handle. Placement of the major components upon the board may be seen in figure 6. The "loopstick" antenna coil is mounted to the top center portion of the board so that it fits directly under the handle of the box. Slightly below and to the right of the coil is the tuning capacitor, C. The midget speaker is mounted in a cut-out in the board at the lower left corner with the output transformer T_1 directly above it. The volume control R_1 is placed directly below the tuning capacitor. The battery clip for the 9-volt cell is placed at the lower right corner of the board. A three terminal phenolic strip is attached to the board above the battery clip. The leads of the 2N112 transistor are soldered to this strip.

Before the components are mounted on the board, it is placed within the plastic box and used as a drilling template for the box. A drill-press and "fly-cutter" may be employed to cut the speaker hole in both the board and the box. The plastic box should be drilled slowly to prevent excessive heat generation and consequent melting of the material.

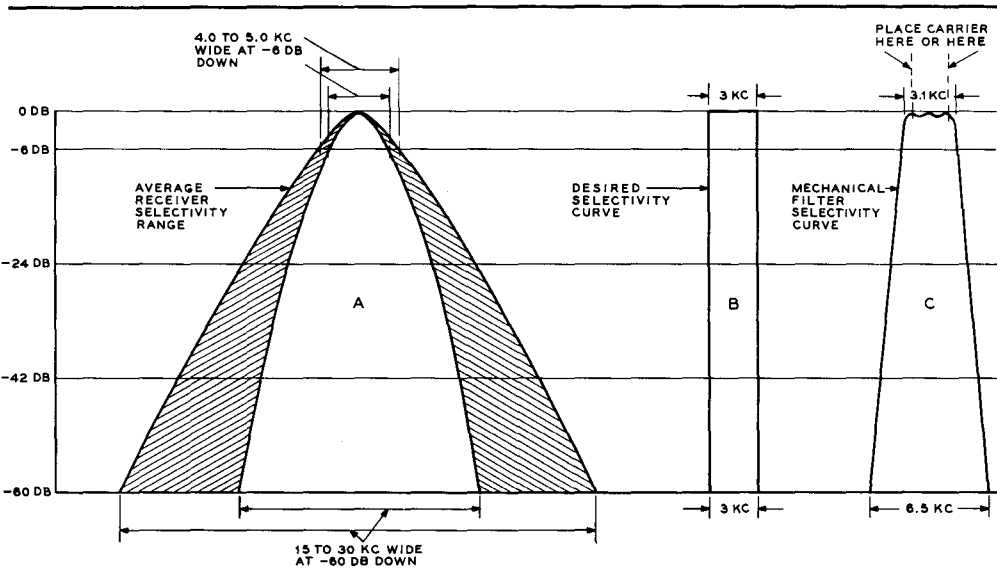

Figure 7

BANDWIDTH CURVES OF VARIOUS I-F SYSTEMS

Bandwidth curves showing: A—Selectivity range of most medium-priced single-conversion receivers with crystal filter out of circuit; B—Ideal selectivity curve for voice reception; and C—Selectivity curve of a 455 kc. mechanical filter with a 3.1 kilocycle bandwidth.

The 2N217 transistor is mounted upon a second three terminal phenolic strip placed between the tuning capacitor and the loud speaker. Use of a composition-type chassis precludes the employment of the chassis as a common ground. A simple bare copper wire is therefore used as a common "ground" return. This lead is actually the "B-plus Bus," shown in figure 5. The lead runs from the positive terminal of the battery clip, along the lower edge of the chassis then up to the "ground" terminal of the "loopstick" coil, L. All components that normally ground to the metal chassis in a conventional assembly are attached to this bus. Be sure to observe the polarity of the electrolytic capacitors and the dry cell. Improper connection of these components can damage the transistors or other parts of the circuit.

The transistors are the last items to be connected into the assembly. Since the transistors are heat sensitive, it is necessary to protect them during the soldering operation. Grasp the transistor lead to be soldered with a long-nose pliers between the body of the transistor and the end of the lead. The thermal capacity of the metal pliers will act as a heat sink, preventing the heat of the iron from damaging the transistor. Be sure to hold the pliers in place until the completed joint has had time to cool. When all wiring is completed and checked, the 9-volt battery can be inserted in the clip (observe polarity!) and the set can be turned on by means of switch S₁. A 0-100 milliamperere d-c meter placed temporarily across the open contacts of switch S₁ can be used to check the transistor operating current. The receiver should play immediately upon closing S₁ as the transistors have no warm-up time. If no external antenna is used, the receiver should be moved about to orient the "loopstick" coil L₁ for best pickup of each individual broadcast station. Adjacent channel interference can often be eliminated by careful rotation of the set to "null out" the offending signal. Ample loudspeaker volume will be obtained from local stations without the use of an external antenna.

Figure 8
455 KC. MECHANICAL
FILTER ADAPTER

Enjoy optimum selectivity and performance from your present receiver by plugging in this simple adapter that replaces the first i-f amplifier tube. The two 6BJ6 tubes are at opposite ends of the chassis with the mechanical filter between them. Adapter plug to fit i-f tube socket is shown in foreground.

27-3 A 455 Kc. Mechanical Filter Adapter

Enjoy modern-style selectivity and performance with your present receiver by plugging in this simple mechanical filter adapter that replaces the first i-f tube!

Many modern medium-priced and older high priced communications receivers now in general use are convenient to operate. The receivers have good frequency stability and adequate sensitivity, but lack sufficient "skirt" selectivity to reject strong signals that are only a few kilocycles higher or lower in frequency from a desired signal. The shaded area of curve A, figure 7 shows the typical selectivity characteristic of popular medium-priced communications receivers. Although the "nose" of this curve is usually only a few kilocycles wide, the "skirt" selectivity 60 decibels down from the peak may be from 15 to 30 kilocycles broad! Small wonder that strong local signals a few kilocycles up the band from the station you are trying to copy may sometimes paralyze your receiver.

It is possible to add a new order of selectivity to your present set by constructing this mechanical filter adapter unit, that is substi-

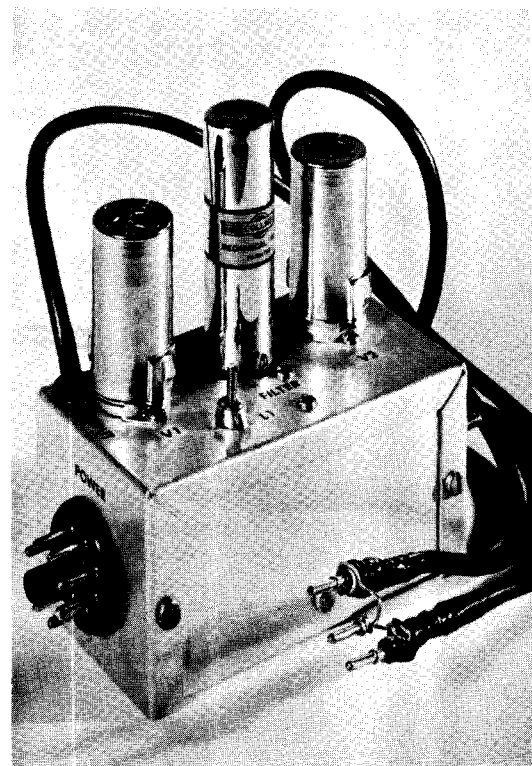

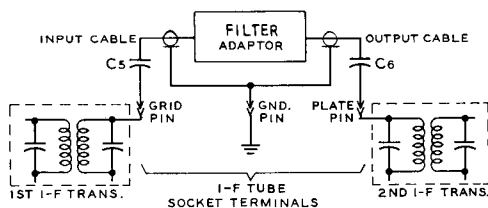

Figure 9
CONNECTIONS BETWEEN
MECHANICAL FILTER,
ADAPTER AND RECEIVER

Adapter makes connections to first i-f socket of receiver. Power may also be obtained from the receiver.

tuted for the first 455 kc. intermediate frequency amplifier tube, without making any under-chassis changes in the receiver. Simply connect the adapter to a power source (which may be your receiver), remove the first i-f amplifier tube, and insert two short coaxial cables into the empty tube socket, as shown in figure 9. These cables carry the i-f signal to and from the adapter, which are then tucked away in an unoccupied corner of your receiver or speaker cabinet.

Selectivity Considerations There are two systems generally used to obtain a bandpass characteristic that approaches the ideal communications selectivity curve for voice modulated signals shown at B in figure 7. One system utilizes a package fil-

ter such as the mechanical filter or a crystal lattice filter. The second system utilizes a string of high Q tuned circuits in the i-f amplifier to achieve the desired passband. This latter system can be space consuming, difficult to adjust, and expensive if quality components are employed.

On the other hand, the mechanical filter is very compact. It is readily available in a variety of bandwidths, has an excellent selectivity curve, and is roughly equivalent in cost to other systems having comparable selectivity. Curve C of figure 7 illustrates the selectivity curve of the 3.1 kilocycle *Collins* mechanical filter which is suitable for A-M phone and single sideband reception.

Circuit Description The complete circuit of the mechanical filter adapter is shown in figure 10. Two 6BJ6 pentode tubes are employed in the circuit to compensate for the insertion loss of the filter. The adapter picks up the 455 kc. signal from the control grid pin of the receiver's first i-f amplifier tube socket through coupling capacitor, C_5 . The signal passes through a coaxial line to the grid of the 6BJ6 amplifier tube, V_1 . The plate circuit of V_1 is capacity coupled to the input terminals of the mechanical filter to keep plate current from flowing through the filter coil. A much wider signal voltage range can be handled by the filter without

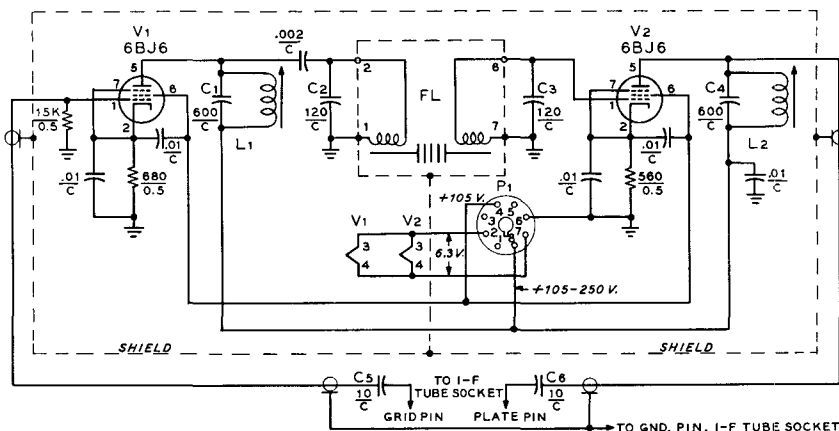

Figure 10
SCHEMATIC OF MECHANICAL FILTER ADAPTER

- C_1, C_2 —600 $\mu\text{fd.}$ ceramic (270- and 330 $\mu\text{fd.}$ in parallel)
 C_3, C_4 —120 $\mu\text{fd.}$ ceramic
 C_5, C_6 —10 $\mu\text{fd.}$ tubular ceramic (Aerovox C1-1)
 FL—455 kc. mechanical filter (3.1 kc. bandwidth) (*Collins* 455J-31)
 L_1, L_2 —200 microhenry slug-tuned "loop stick" coil (*Superex* VL, or *J. W. Miller* 6300)
 P1—Male octal plug with retaining ring (*Amphenol* 86-PM8)
 R1—18K, 10 watt. Place between pins 4 and 8 of P1 socket for plate supply greater than 130 volts. Use jumper for 130 volts or less (see text). R1 is screen voltage dropping resistor.

Construction of the Adapter The adapter is constructed on an aluminum box measuring $2\frac{1}{4}$ " x $2\frac{1}{4}$ " x 4", a good compromise size that is compact, yet not too small for easy wiring. The primary design and construction consideration of this adapter is to completely isolate the input and output circuits. Any stray coupling can cause signal leakage around the filter unit, thus impairing its effectiveness. The construction shown allows maximum isolation, yet permits simplicity of construction. A drilling template for the box is given in figure 12, and the placement of the major components may be seen in figures 8, 13, and 14. Note that the input and output circuits are isolated within the box by a shield passing across the center of the filter socket.

After drilling and punching all holes, the tube and mechanical filter sockets, power plug, and rubber grommets may be assembled. Place solder lugs under all socket retaining bolts for ground connections. Before any wiring is done a 3" x 3" piece of perforated aluminum (*Reynold's "Do-it-yourself"* aluminum, available at large hardware stores) is formed into the shield shown in figures 13 and 14. A $\frac{3}{8}$ " flange is bent along all edges of this shield except where it crosses the center of the 9-pin filter socket. A small notch is cut in the shield next to the socket to pass the heater and plate power leads to the V₂ socket. The shield passes across the filter socket between pins 3 and 4, and 8 and 9, then is bolted to a soldering lug that has been soldered to pin 1 of the filter socket. The flange is also bolted to the top of the box directly above coil L₂, and two self-tapping sheet metal screws are driven into the side flanges of the shield when the other half of the box is assembled.

Cable Assembly Constructing the two i-f tube socket cables takes little time if the assembly shown in figure 15 is followed. First, cut two lengths of RG-58/U coaxial cable 17 inches long and remove $1\frac{1}{2}$ inches of the vinyl cover on one end of each piece. Slide the braided outer shield back over the outer cover and trim the insulation and center conductor so that $\frac{1}{2}$ inch protrudes beyond the shield. Next cut the insulation to expose $\frac{1}{4}$ inch of the center conductor and trim one lead of the coupling capacitor C₃ soldering it to the center conductor with a $\frac{1}{4}$ inch overlap. Cut narrow strips of plastic insulating tape and wrap them around this joint up to the body diameter of the capacitor as shown in figure 15. Finally, slide the braided shield over the capacitor, pull it tight and wrap a short length of tinned copper wire twice around the middle of the capacitor. Solder the wire to the shield and trim off the excess shielding. The tinned wires from each cable are then soldered to a pin taken from an octal tube base, making a plug-in ground connection as shown in figure 8. Similar tube base pins are soldered to the other leads, and the excess lead trimmed off. The exposed cable shield is then wrapped with plastic tape.

If the receiver has a 7-pin miniature tube in the first i-f amplifier stage, short lengths of #18 tinned wire may be used for the plug-in pins on the cables, or the capacitors and ground lead may be soldered to a special 7-pin miniature male adapter plug (*Vector P-7*).

Adapter Wiring For easy parts assembly, the filter shield may be temporarily removed, and replaced when wiring is completed. Heater, screen and plate power wires are installed first, keeping all such leads close to the box wherever possible to minimize

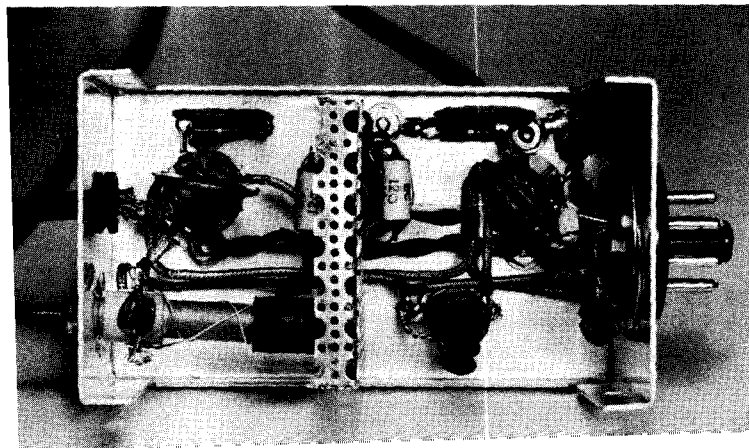

Figure 13
UNDERCHASSIS
VIEW OF THE
ADAPTER

Slug-tuned coil L₂ is at left, below the second stage 6B J6 socket. Screen bypass capacitor is placed across socket. Capacitors C₂ and C₃ may be seen on each side of the center shield. Coil L₁ is at right of shield. Input cable is at far right. Output cable passes through rear wall of chassis at left. Power leads pass through center of shield.

stray signal pickup. The smaller components are now soldered in place, after which the coaxial cable input and output leads are connected. About $\frac{3}{8}$ inch of the outer vinyl jacket is removed from the cables and the shield braid is twisted into a single conductor. The cable ends are brought into the box through rubber grommets. The twisted cable shield is soldered to a nearby ground lug and the center conductor is soldered to the correct tube socket pin. Finally coils L_1 and L_2 and their associated capacitors are placed in position and wired into the circuit.

Alignment of the Adapter The adapter is connected to the communications receiver as previously described, following a wiring and power check to ensure that the correct voltages are applied to the various tube elements. The receiver should then be tuned to the center of a strong, steady local signal. If the receiver has an S-meter, the a-v-c should be left on. The slugs of coils L_1 and L_2 are now tuned for maximum carrier strength reading on the S-meter. If the receiver has no S-meter, a modulated signal from a test oscillator must be used in conjunction with a vacuum tube voltmeter placed across the audio output circuit of the receiver. Tuning adjustments on the first and second i-f transformers in the receiver are also recommended for maximum output of the adapter.

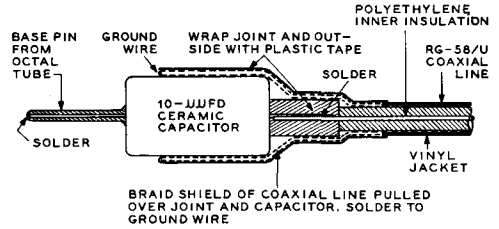

Figure 15
CROSS-SECTION VIEW OF SIGNAL CABLES

Receiver Tuning Techniques A somewhat different tuning technique should be used for tuning A-M and single sideband signals on a receiver following installation of the mechanical filter adapter. Modulated signals with carrier should be tuned in so that the carrier is placed on one edge, rather than in the center of the i-f passband (figure 7). Only one sideband of an A-M signal will be heard at one time, and the receiver tuning may be shifted so that the sideband on which a heterodyne is present may be "pushed off the edge" of the bandpass curve of the i-f system.

When receiving single sideband or c-w signals the beat frequency oscillator of the receiver is turned on and adjusted so that the frequency of the b-f-o is near one edge of the

Figure 14

OBLIQUE VIEW OF ADAPTER CHASSIS

Coil L_1 is at left near power plug, with coil L_2 mounted horizontally at right. Note C_2 and C_3 are placed directly across pins of mechanical crystal socket.

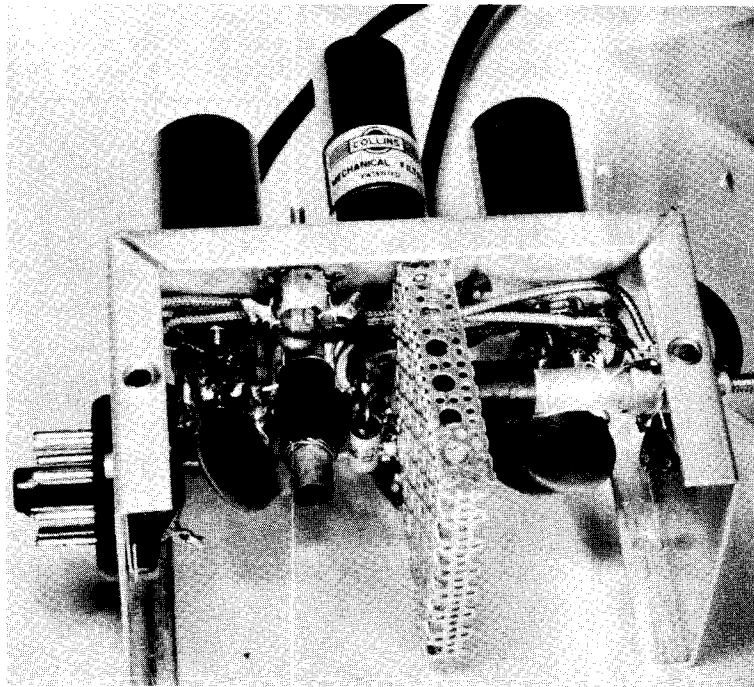



Figure 16
FRONT VIEW OF AMATEUR
BAND RECEIVER

6-band receiver covers 80-6 meters, using TV turret for "front end." Mechanical filters provide optimum selectivity.

filter passband. The proper pitch control setting may be determined by tuning the receiver across a carrier while adjusting the pitch control so that a beat note on only one side of zero beat is heard. After marking this setting of the pitch control, again turn it so the test signal on only the other side of zero beat is heard. Mark this setting, then try tuning in a single sideband signal. If intelligible speech cannot be heard, shift the b-f-o pitch control to the other setting. Small adjustments of the pitch control and the tuning of the receiver will produce the correct voice tones. For best reception, the audio control of the receiver should be fully advanced, and only enough r-f gain used to produce a readable signal. Volume is therefore controlled by the r-f gain control.

For optimum c-w reception, the 0.5 kc. mechanical filter may be used. No changes need be made to the adapter when filters are changed.

27-4 A High Performance Amateur Band Receiver

This receiver was designed for outstanding performance on the 80, 40, 20, 15, 10, and 6 meter amateur bands. It incorporates many up-to-date features such as mechanical filters for optimum selectivity, double conversion for freedom from images, and a novel r-f assembly for mechanical stability and good operating efficiency on the higher frequencies. The receiver uses 12 tubes, plus a selenium rectifier power supply. The complete r-f assembly is designed about a television turret tuner having positions for 12 separate bands. The rugged construction and excellence of the self-wiping contacts of the TV tuner add greatly to the overall stability of the receiver. Complete dial calibration and an S-meter provide maximum tuning simplicity and logging ease.

Because of the "snap-in" coil strips of the tuner it is possible to provide coils to tune any narrow segment of the shortwave range between 3.5 megacycles and 75 megacycles. For example, coils can be wound to cover the 13, 19, 21, 31, and 49 meter international shortwave broadcast bands if desired. Panel control of the selectivity allows instant selection of the optimum passband for either voice or c-w reception. The receiver is entirely self-contained except for an external speaker.

Circuit Description The High Performance Amateur Band Receiver is a double conversion superhetrodyne (figure 17). A modified TV turret tuner is employed to cover six amateur bands. The turret

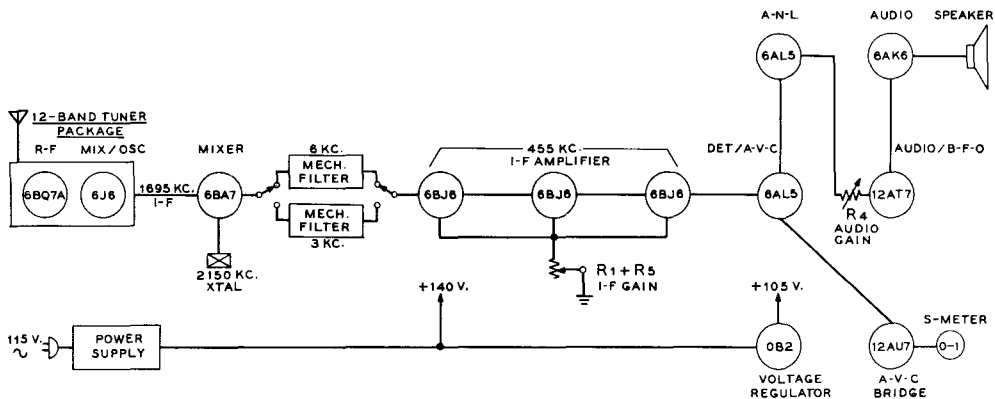
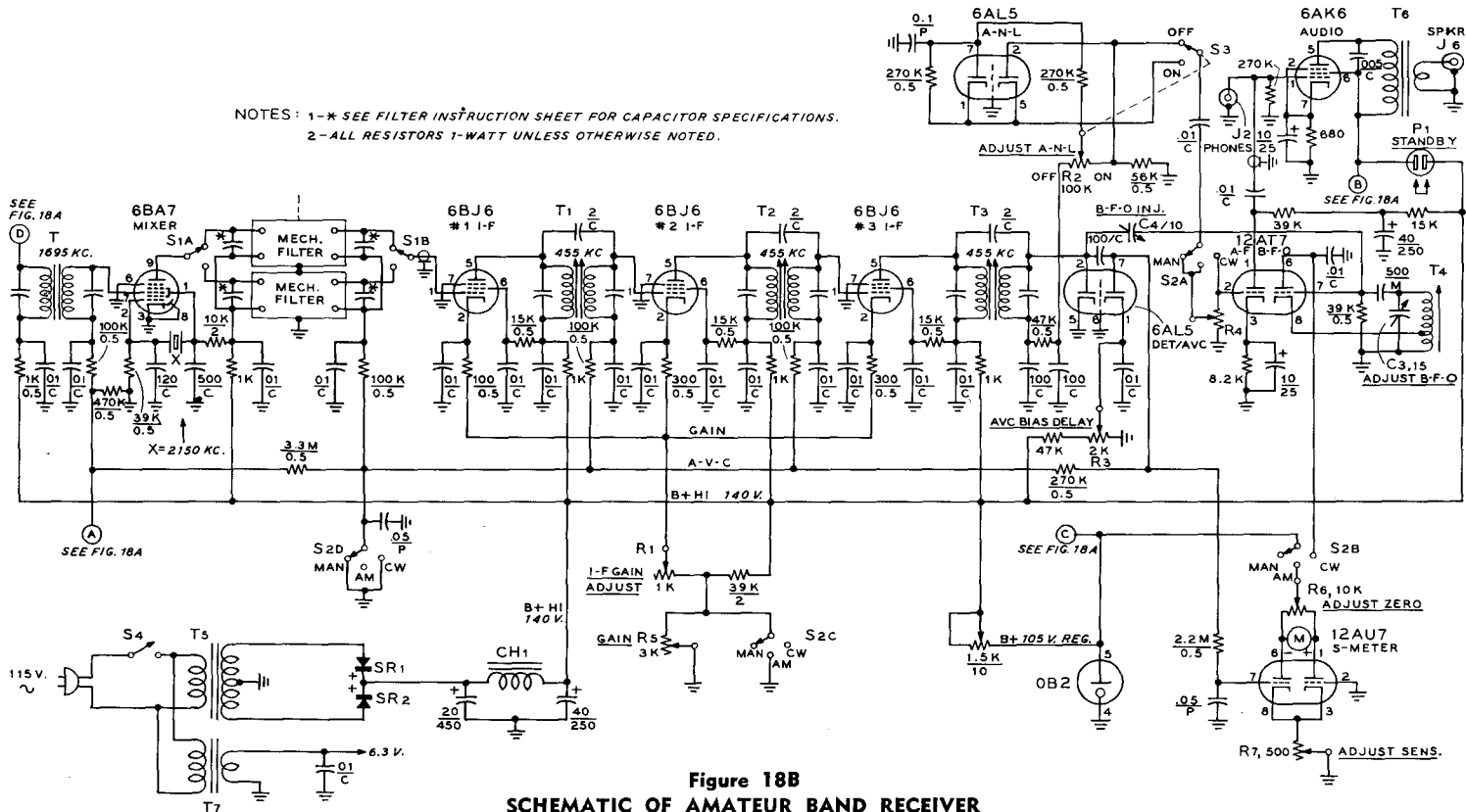

Figure 17
BLOCK DIAGRAM OF DE-LUXE AMATEUR COMMUNICATION RECEIVER

NOTES: 1—* SEE FILTER INSTRUCTION SHEET FOR CAPACITOR SPECIFICATIONS.
2—ALL RESISTORS 1-WATT UNLESS OTHERWISE NOTED.



The "front-end" circuit is shown in Figure 18A. The tuning capacitors placed across the input and output circuits of the mechanical filters are determined by their type. See filter specification sheet. Type F455C filters were used in this receiver.

M—0-1 d-c milliammeter, 1-inch diameter

S₁A-B—DPDT rotary switch, Centralab PA-2001 decks, with Centralab PA-302 index assembly

S₂A-B-C-D—4 pole, 3 position switch, Centralab PA-1013

T—1500 kc. i-f transformer, J. W. Miller Co. 512-W1. Remove turns from primary and secondary to permit resonance at 1695 kc.

T₁-T₂—455 kc. i-f transformer, J. W. Miller Co. 12-C1, or equivalent

T₃—455 kc. diode transformer, J. W. Miller Co. 12-C2, or equivalent

T₄—455 kc. BFO transformer, J. W. Miller Co. 112-C5, or equivalent

T₅—150-0-150 volts at 100 ma. UTC S-51

T₆—10 K pri., 4 ohm sec., Stancor A-3879

T₇—6.3 volts, 3 amp., Stancor P-6466

reading on the 0-1 d-c milliammeter connected between the plates of the 12AU7 triodes.

The selenium rectifier power supply delivers 140 volts at the receiver current drain of 65 milliamperes. The low plate voltage and small power consumption of the receiver result in a very low degree of thermal drift. If desired, the selenium supply may be replaced with a more conventional supply using a 5Y3-GT rectifier tube. Plate voltage to the receiver should be held below 160 volts. Plate voltage to the 6J6 oscillator section and the 12AU7 S-meter tube is regulated by an OB2 gas regulator.

Plate voltage is removed from the r-f and audio stages when the receiver is in "standby" condition. All oscillators are left running continuously to reduce initial warmup drift.

Receiver Layout The receiver is built upon a plated steel chassis measuring 8" x 15" x 2½". Panel height is 8". To achieve maximum rigidity, the panel is braced to the chassis with two steel angle brackets visible in figure 19. The tuning dial is centered on the panel, and the three gang tuning capacitor is behind the dial, on the center-line of the chassis. Directly to the left of the tuning capacitor is a 3½" x 5" cut-out in the chassis. The TV tuner is placed in this cut-out, held in place by two 3" angle brackets cut from aluminum stock. Height of the tuner above the chassis is determined by the shaft of the tuner which must pass through the bushing drilled in the lower left corner of the dial escutcheon. Likewise, the placement of the

three gang tuning capacitor C_1 is determined by the shaft height of the main dial bushing. C_1 is therefore mounted above the chassis by means of long 6-32 bolts and steel spacers.

Placement of the major components may be seen in figures 19 and 20. The two mechanical filters are mounted to the left of the tuner, directly behind the 6BA7 mixer tube and the 1695 kc. i-f transformer, T_1 . The filter selection switch S_1 is mounted below chassis so that the switch segments fall over the filter terminals. This switch is made up from a switch kit, and is mounted in place by means of two brackets cut from soft aluminum. One bracket holds the front panel bushing of the switch, and the other is placed just forward of section S_1B and holds the two fixed shafts of the switch. A hole is cut in the center of the bracket to clear the rotary shaft of the switch. This bracket also serves as a shield isolating the output circuits of the mechanical filter from the input circuits. The particular switch used is highly recommended, and it is suggested that no substitution be made. It is imperative that the drive shaft of the switch be metal, and that it is securely grounded. Some switches have fibre drive shafts, or metal shafts held in position with a cotter pin. Fibre drive shafts permit signal leakage along the shaft, deteriorating filter performance, and the cotter pin-type switch does not insure the shaft is securely grounded which is mandatory, when the metal shaft-type switch is used.

The three intermediate frequency stages are spaced along the back of the chassis. At the right rear are the 6AK6 audio stage, the volt-

Figure 19
TOP VIEW OF
AMATEUR
COMMUNICATION
RECEIVER

Mechanical filters are at left with three stage i-f amplifier along rear of chassis. The TV tuner is mounted in chassis cut-out to the left of main tuning capacitor. Power supply and audio section occupy right-hand section of steel chassis. Six channels of tuner are used to cover the amateur bands between 80- and 6-meters. Six spare channels may be used to cover shortwave broadcast bands, or portions of 100 Mc. region.

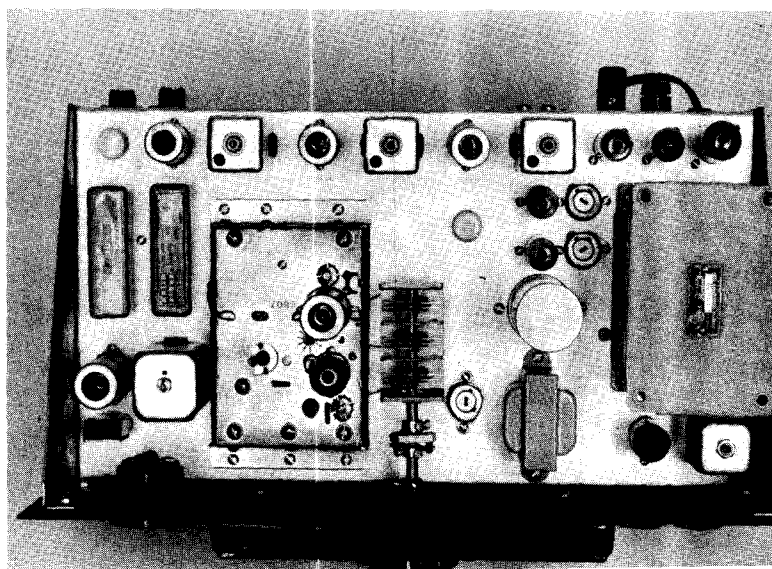

age regulator tube, and the 12AU7 S-meter tube. In front of the last i-f transformer can be the two 6AL5 tubes and potentiometers R_6 and R_7 .

At the right end of the chassis is the power transformer, and between it and the panel is the b-f-o transformer and the 12AT7 audio/b-f-o tube. Between the power transformer and the three gang tuning capacitor are the power supply filter capacitor and the auxiliary filament transformer. The i-f gain control potentiometer R_1 is placed between the filament transformer and the main tuning capacitor.

Placement of the smaller components below the chassis may be seen in figure 20. The TV turret and mechanical filter switch are at the right of the chassis, with the audio output transformer mounted to the back wall of the chassis near the turret. The filter choke for the power supply is mounted to the left side wall of the chassis, with the two selenium rectifiers in front of it. The 10 watt dropping resistor for the regulator tube is mounted to the chassis between the filter choke and the rear tube sockets.

Receiver Construction The receiver should be built in two parts to simplify construction. The power supply, audio and 455 kc. i-f sections are built first, and the receiver is placed in operating condition up to the 1695 kc. i-f channel. The TV tuner is then modified, using the rest of the receiver for alignment and adjustment tests.

All major components should be marked in position on the paper wrapper of the chassis

which is then drilled and punched. All major components with the exception of the TV turret are mounted in place. The ground connections at each tube socket are made first, then the filament leads are wired in position. Use #14 insulated wire for the filament leads, as the current drain is quite high. The power supply should be wired first and tested. It should deliver approximately 140 volts across a 2000 ohm, 10 watt resistor used as a temporary dummy load. When the power supply section is completed, the audio stages, b-f-o, S-meter, second detector, and noise limiter stages can be wired. Operation of the audio system may be checked by injecting a small audio signal on pin #2 of the 12AT7 stage and checking the volume of the tone in the loud speaker.

The next step is to wire the three i-f amplifiers and the a-v-c circuit. Five terminal phenolic tie-point strips are mounted in front of each i-f tube socket. The a-v-c, cathode bias, and screen dropping resistors are mounted between the socket pins and the terminals of the strip. The ceramic bypass capacitors are soldered directly between socket pins with the shortest possible leads. All interconnecting wiring is done between the terminal strips. After the i-f strip has been wired up to the arm of switch S_1 , segment B, the amplifier may be tested. Pin #1 of the first 6BJ6 i-f tube is temporarily returned to the a-v-c bus by placing a 100 K resistor across the output pins of the mechanical filter socket. Switch S_1 is adjusted to place the resistor in the circuit.

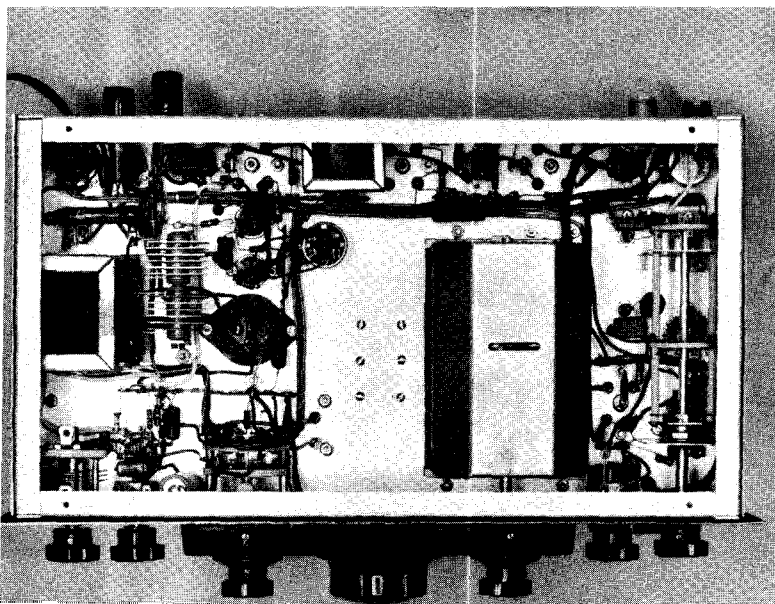

Figure 20
UNDER-CHASSIS
VIEW OF AMATEUR
BAND RECEIVER

To the left of the chassis are the selenium rectifiers and the filter choke. At the extreme right is the mechanical filter selector switch mounted on two aluminum brackets. The controls along the panel are (left to right): BFO, AUDIO GAIN, MAN---AM---CW, tuning control, TV turret switch, R-F GAIN, and filter selector switch. Output transformer is mounted to back of chassis.

A signal generator having a tone modulated 455 kc. signal is attached to the input grid of the 6BJ6 tube, and an a-c voltmeter is connected across the speaker terminals. To insure that the i-f system is aligned at the center of the filter passband it is imperative that the alignment frequency be very close to 455.0 kc. The use of a BC-221 or equivalent signal generator is recommended. As the transformers are brought into alignment the input signal to the i-f strip should be decreased. A vacuum tube voltmeter may be employed to measure the negative voltage developed on the a-v-c bus. A maximum voltage of about -8 volts is developed with a strong input signal to the i-f strip. Overall gain is controlled by the setting of R₁ when switch S₂ is placed in the "A-M" position.

After i-f alignment has been completed, the 100 K input resistor should be removed from the filter socket and the 6BA7 mixer stage wired. The capacitors connected between pins 1 and 2 and ground of the 6BA7 socket determine the level of excitation to the 2150 kc. crystal. If difficulty is encountered in obtaining consistent oscillation, the value of one or both of these capacitors may be altered until reliable oscillation is obtained. Operation of the crystal oscillator may be monitored with a nearby receiver tuned to the crystal frequency. When the oscillator is working properly, a 1695 kc. tone modulated signal should be

coupled through a 0.01 μfd. blocking capacitor to the "hot" end of the primary winding of transformer T. This transformer is adjusted for maximum output signal. The receiver is now ready for tuner installation.

Tuner Modification

The tuner used in this receiver is a *Standard Coil Co.* replacement type unit using a 6BQ7A cascode r-f amplifier and a 6J6 mixer stage. Several different variations of this tuner can be purchased at nominal prices through large wholesale outlet stores. The tuner has snap-in coil strips for 12 TV channels, and may have either a 21 Mc. or 42 Mc. i-f output range. Several simple changes must be made to the tuner for use in this receiver. The i-f output coil and the cascode neutralizing circuit must be removed. The best thing to do is to remove all the clip-in coils and trace out the tuner circuit, and then compare it with the circuit shown in figure 18A. Cathode bias must be added to the first section of the cascode and several of the resistors in the tuner must be changed. Rewire the tuner according to the circuit of figure 18A. Note that regulated voltage is applied to the oscillator section of the 6J6 and that a-v-c voltage is applied to the first section of the 6BQ7A. The main tuning capacitor C1A-B-C is connected to the appropriate points in the tuner by three short leads. A ¼-inch coil is drilled in the rear of the

FIGURE 21 - COIL TABLE FOR AMATEUR BAND RECEIVER

BAND	COIL	WINDING AND WIRE SIZE	SPACING	SHUNT CAPACITY	NATURAL RESONANCE	BAND	COIL	WINDING AND WIRE SIZE	SPACING	SHUNT CAPACITY	NATURAL RESONANCE
6M	L ₁	ANT.: 3 T. N° 22 E.	C-W	—	—	20M	L ₁	ANT.: 7 T. N° 22 E.	C-W	—	—
		GRID: 5 T. N° 18 E.	WIRE DIA.	56 μJFD.	63 MC.			GRID: 13 T. N° 22 E.	C-W	180 μJFD.	15.2 MC.
	PLATE, R-F: 5 T. N° 18 E.	WIRE DIA.	82 μJFD.	63 MC.	L ₂		PLATE, R-F: 13 T. N° 22 E.	WIRE DIA.	200 μJFD.	14.75 MC.	
	GRID, OSC.: 5 T. N° 18 E.	WIRE DIA.	62 μJFD.	62 MC.			GRID, OSC.: 12 T. N° 22 E.	WIRE DIA.	200 μJFD.	17 MC.	
		PLATE, OSC.: 5 T. N° 18 E.	C-W	—	—			PLATE, OSC.: 10 T. N° 30 E.	C-W	—	—
10M	L ₁	ANT.: 10 T. N° 22 E.	C-W	—	—	40M	L ₁	ANT.: 15 T. N° 30 E.	C-W	—	—
		GRID: 10 T. N° 22 E.	WIRE DIA.	75 μJFD.	33 MC.			GRID: 39 T. N° 30 E.	C-W	100 μJFD.	7.9 MC.
	PLATE, R-F: 10 T. N° 22 E.	WIRE DIA.	62 μJFD.	32 MC.	L ₂		PLATE, R-F: 38 T. N° 30 E.	C-W	110 μJFD.	7.8 MC.	
	GRID, OSC.: 10 T. N° 22 E.	WIRE DIA.	68 μJFD.	32.5 MC.			GRID, OSC.: 25 T. N° 30 E.	C-W	110 μJFD.	10 MC.	
		PLATE, OSC.: 9 T. N° 30 E.	C-W	—	—			PLATE, OSC.: 12 T. N° 30 E.	C-W	—	—
15M	L ₁	ANT.: 9 T. N° 22 E.	C-W	—	—	80M	L ₁	ANT.: 10 T. N° 30 E.	C-W	—	—
		GRID: 9 T. N° 22 E.	WIRE DIA.	150 μJFD.	22.3 MC.			GRID: "LOOPSTICK" B-C COIL REMOVE TURNS TO RESONANCE.	15 μJFD.	5.4 MC.	
	PLATE, R-F: 10 T. N° 22 E.	WIRE DIA.	120 μJFD.	22.25 MC.	L ₂		PLATE, R-F: SEE L ₁ ABOVE	12 μJFD.	5.7 MC.		
	GRID, OSC.: 10 T. N° 22 E.	WIRE DIA.	220 μJFD.	21.0 MC.			GRID, OSC.: SEE L ₁ ABOVE	39 μJFD.	7.2 MC.		
		PLATE, OSC.: 10 T. N° 30 E.	C-W	—	—			PLATE, OSC.: 20 T. N° 30 E.	C-W	—	—

NOTE 1 - GRID WINDING OF OSCILLATOR COIL L₂ IS PLACED NEXT TO OSCILLATOR PLATE WINDING. R-F PLATE WINDING IS PLACED ABOUT 1/2-INCH AWAY FROM OSCILLATOR-GRID WINDING.

2 - ANTENNA COIL SPACED ABOUT 1/16-INCH FROM GRID COIL.

3 - 10 K RESISTOR PLACED ACROSS 80 METER R-F GRID COIL.

4 - RESONANT FREQUENCY MEASURED WITH SHUNT CAPACITOR ACROSS COIL.

tuner case to permit the coaxial lead from the antenna receptacle to enter the tuner. The tuner is now ready to be mounted in the receiver.

Tuner Coil Modification

The tuner coils should be removed from their snap-in holders. Notice that the r-f coils have five terminals and that the mixer-oscillator coils have six terminals. All coil forms and windings are removed from the clip-in assemblies and may be discarded. The new coils for all bands are to be wound on lengths of 1/4-inch diameter polystyrene rod, cut to fit into the assembly clamps. For this particular tuner, the r-f coil forms are 1 1/8" long and the oscillator mixer coil forms are 1 13/16" long. The ends of the forms are tapered slightly with a file so that they fit into the slotted ends of the assembly clamp. After each set of coils is completed the frequency band notation is marked on the unit for future identification.

Complete coil data is given in figure 21 and a complete set of coils is shown in figure 22. Start with the ten meter coils, as they have few turns and are easy to wind. Make the r-f stage coil first. The windings may be tem-

porarily held in place with a small piece of cellophane tape until the coil form is cemented in the assembly clamp with *Duco* cement. The coil leads are then cleaned and soldered to the corresponding terminals. After the shunt capacity is added, the natural resonance of the winding should be checked against the value given in figure 21. The coil should be suspended in the clear and checked with a grid-dip oscillator. Turn spacing may be varied to produce the correct resonance point. The mixer-oscillator coil is wound next. The two tuned windings are placed at the ends of the form and the oscillator plate winding is placed between them, positioned close to the grid winding as illustrated in figure 22. The coil windings may be held in position with a temporary piece of cellophane tape. This coil is adjusted in the same manner as the r-f coil. When completed, the mixer-oscillator coil may be snapped into the tuner and the receiver turned on. The oscillator operates on the low frequency side of the signal for 10 meter reception, covering the range of 26.3 Mc. to 28.0 Mc. as the receiver is tuned from 27,995 kc. to 29.7 Mc. Listen for the oscillator in a nearby receiver. The frequency range of the oscillator can be set by varying the spacing of the turns of the 6J6 oscillator coil, and also by adjustment of the oscillator trimmer capacitor C_2 in the tuner. When the correct frequency range is covered the winding may be permanently held in place with a small application of *Duco* cement. Check the frequency range once again after you apply the cement as the frequency shifts slightly lower as the cement is applied. Make your final correction before the cement dries. The other coil windings are relatively non-critical and require no adjustments after they are completed.

Once the oscillator tuning range has been set, the signal generator may be used to calibrate the main dial of the receiver. If care is used in this process, the dial calibrations can be read to an accuracy of five kilocycles or less. The oscillator injection voltage may be checked at *terminal A* on the tuner with a v-t-v-m. The injection range should lie between two to three volts on each band, and may be controlled by varying the spacing between the

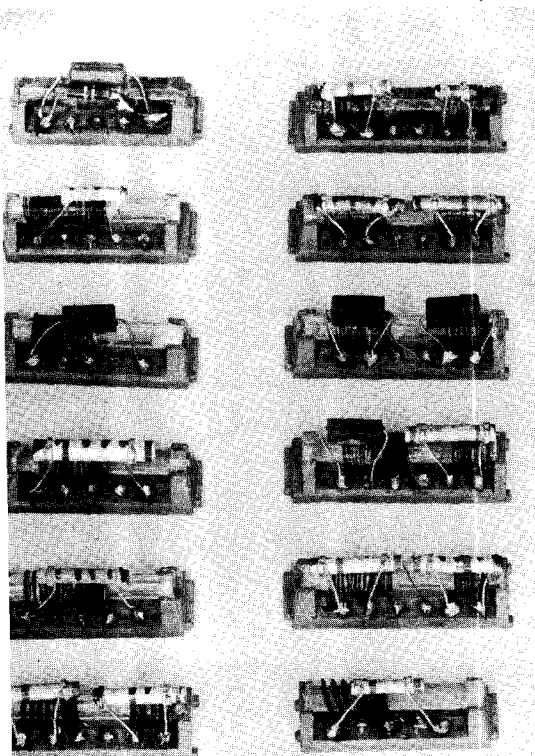

Figure 22
COIL SET FOR AMATEUR
BAND RECEIVER

Tuner coils are wound on 1/4-inch polystyrene rods. R-f coils are at left, with mixer-oscillator coils at right. 80 meter coils are at top of photo, with 6 meter coils at bottom.

oscillator grid winding and the untuned plate winding. These adjustments may be made with the coils in the receiver by removing the bottom and side plates of the tuner.

The conversion oscillator operates on the high frequency side of the signal on the 15, 20, 40, and 80 meter bands, as tabulated in figure 21. The 80 coils are made from "loop-stick"-type broadcast coils. Turns are removed from these coils until the natural resonance falls at the desired frequency as shown in the table. A small value of capacitance is used across these coils since the percentage-tuning range is quite high.

Receiver Adjustment After the first set of coils has been completed, the receiver may be adjusted for optimum results. A balance between r-f gain and i-f gain must be achieved. Under normal operating conditions, the residual noise picked up by the antenna system should mask out the internal noise level of the receiver. If the antenna is removed from the receiver and the internal noise level does not drop appreciably it is usually a sign that the i-f gain of the receiver is too high and the r-f gain is too low. The value of i-f gain may be controlled by the setting of R_1 . Normally, there is no instability or regeneration in the i-f strip. The stability, however, is dependent to some extent upon the wiring technique you use; it may be necessary to retard the i-f gain level to prevent instability. Receiver i-f gain may be further decreased by increasing the value of the cathode resistor of the first 6BJ6 stage. I-f gain may be increased by decreasing the value of the cathode resistors of the second two i-f stages.

The a-v-c bias delay potentiometer R_3 should be set to provide about one volt of bias on pin #1 of the 6AL5 a-v-c rectifier. This will retard a-v-c action on weak signals and improve the signal-to-noise ratio of threshold signals.

The level of beat oscillator injection can be set by varying the setting of coupling capacitor C_1 . Sufficient injection should be used to provide good reception of single sideband signals. The injection level is not critical for c-w operation. Finally, the b-f-o capacitor C_2 should be set at mid-scale and the slug of transformer T_1 adjusted until the b-f-o signal is tuned exactly to 455 kc.

The response of the S-meter is controlled by the time constant in the grid of the 12AU7 meter tube. If the grid capacitor in this circuit is increased in value from .05 μ fd. to 1.0 μ fd.

the S-meter will respond much more slowly to changes in signal strength. The value of this capacitor can be altered to suit the user's taste.

Finally, various settings of the noise limiter threshold control R_2 should be tried to find the best clipping level for various types of pulse-type interference.

Receiver Operation Receiver tuning is extremely smooth, and the dial calibration remains as good as the original calibration. The r-f input circuits are designed for 50-100 ohm unbalanced transmission line on all amateur bands, and r-f stage resonance may be easily attained by means of the antenna trimming capacitor located within the set. For phone reception, switch S_2 is set to A-M and the audio level is controlled by the audio potentiometer R_4 . For c-w or sideband reception S_2 is set to C-W and audio control R_4 is fully advanced. Receiver gain is now controlled by the R-F gain potentiometer R_5 . The B-F-O pitch control C_3 is adjusted to place the oscillator on the edge of the filter pass-band for "single signal" reception of c-w signals or single sideband reception of SSB transmissions. The S-meter is operative on the "A-M" position of S_2 ; S-meter sensitivity is controlled by potentiometer R_7 .

27-5 A "Handie - Talkie" for 144 Mc.

The 144 Mc. band is the ideal frequency range for short-haul, portable equipment. Little power is required for local coverage, and the antenna size is moderate. Then too, this is just about the highest frequency at which filament type battery tubes will operate.

Shown in the accompanying illustrations is a battery powered, crystal controlled "handie-talkie" designed for operation in the 2 meter region. It is especially well suited for Civil Defense work or emergency service. This unit was designed after the AN/URC-4 air-sea rescue transmitter, and is completely self-contained, including batteries.

Circuit Description The circuit of the "handie-talkie" is shown in figure 24.

Six quick heating filament type tubes are used. Two tubes are used in the transmitter portion of the transceiver, two in the receiver portion, and the remaining two in the common audio section.

The transmitting portion of the unit employs a 3A5 dual triode and a 3A4 pentode.

The first triode section of the 3A5 serves as an overtone crystal oscillator, delivering 24 Mc. energy from an 8 Mc. crystal. The crystal oscillates in series mode and sufficient regeneration is introduced in the circuit by returning the crystal circuit to a tap on the oscillator plate coil. The oscillator may be adjusted by tuning the slug of coil L₁. The 24 Mc. plate circuit of the oscillator stage is capacitively coupled to a 3A4 pentode tripler stage whose plate circuit is tuned to 72 Mc. This stage is resonated by means of the slug of coil L₂. The 3A4, in turn, is capacitively coupled to the second section of the original 3A5 which

serves as a doubler from 72 Mc. to 144 Mc. Tuning of the plate circuit is accomplished by the slug of coil L₃. Inductive coupling is used between L₃ and the quarter-wave whip antenna.

The receiver employs a 5678 sub-miniature pentode r-f stage to provide a better signal-to-noise ratio and also to reduce spurious radiation from the super-regenerative detector. At a distance of fifty feet from the transceiver, the detector radiation is inaudible to a sensitive receiver. In the interest of economy, the 5678 can be replaced with a 959 "acorn" tube if miniaturization of the unit is not desired. The super-regenerative detector uses a special quench circuit which provides smooth operation yet allows the usual variable quench control to be eliminated. Values shown in the schematic are optimum, and care should be taken to keep all leads short. Capacitor C₁ is the receiver tuning control and has a range of 140 Mc. to 150 Mc. If it is desired to reduce the tuning range, one or two plates can be removed from C₁ and coil L₃ readjusted accordingly. The 5676 can be replaced by a 957 "acorn" tube in the interest of economy.

Audio output from the super-regenerative detector is passed through a simple R-C filter to suppress the quench frequencies. The first audio stage is a 1S5 pentode using contact potential grid bias. Interstage coupling is accomplished by a *Centralab Couplate* printed circuit incorporating the six components required at this juncture. If this item is not available, the values of resistance and capacitance shown can be substituted. The output stage consists of a 3Q4 power pentode driving a 2½-inch speaker through the output transformer T₁. For reception only one-half of the 3Q4 filament is used to conserve "A" and "B" battery drain. During transmit periods the extra audio is needed and the other half of the filament is energized.

The "send-receive" switch S₁A-B-C-D-E is a miniature ceramic rotary switch. Section A switches the antenna from the receiver to the transmitter. Section B energizes the filaments of the receiver r-f tubes on the "receive" position, and energizes the microphone and the second section of the 3Q4 filament on the "transmit" position. Section C turns off all filaments in the "off" position, and section D opens the 67.5 volt battery circuit in the "off" position. Section E connects the loudspeaker to the audio system in the "receive" position of switch S₁. The extreme counterclockwise position of S₁ is the "off" position.

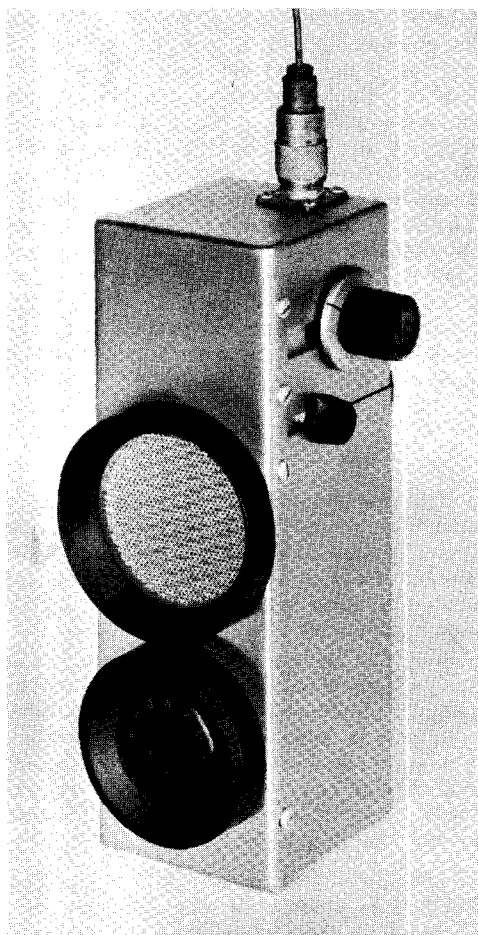

Figure 23
BATTERY POWERED "HANDIE-TALKIE" FOR 2 METERS

Completely self-contained transceiver employs crystal controlled transmitter for greatest stability. Send-receive switch is at top right with tuning control of receiver directly below.

Under normal operating conditions the transceiver is held like a telephone and a short whip antenna is used. The operating range may be extended by removing the whip and using a beam, connected to the unit by a length of 52-ohm coaxial transmission line.

Three separate battery voltages are required by the "handie-talkie." 1½-volts is required for the filament circuit, 4.5 volts is required for grid bias of the 3Q4 audio stage, and 67.5 volts is required for the plate voltage. All these voltages may be obtained from miniature batteries placed within the case of the transceiver.

Transceiver Layout No hard and fast assembly procedure is given for this unit, since each builder will want to custom-fit the circuit into his particular case. The unit shown in the photographs was built

within a steel box measuring 9" long by 2¾" wide by 2⅝" deep. The width and depth dimensions were determined by the size of the battery pack. The "front" of the cabinet is one piece with flanged edges. The microphone and speaker are attached to this portion of the box. The transceiver chassis is custom designed to fit the available components and is held to the front of the box by two 6-32 bolts through the rear of the speaker frame. The rear and sides of the cabinet serve merely as a dust shield as no components are fastened to them, except for the coaxial antenna receptacle. The portion of the cabinet directly over the batteries is separately removable to permit easy access to the battery pack. The remaining portion of the cabinet is affixed permanently to the front piece by means of sheet metal screws. The crystal projects through a cut-out in this piece, and there are three ⅜-inch holes

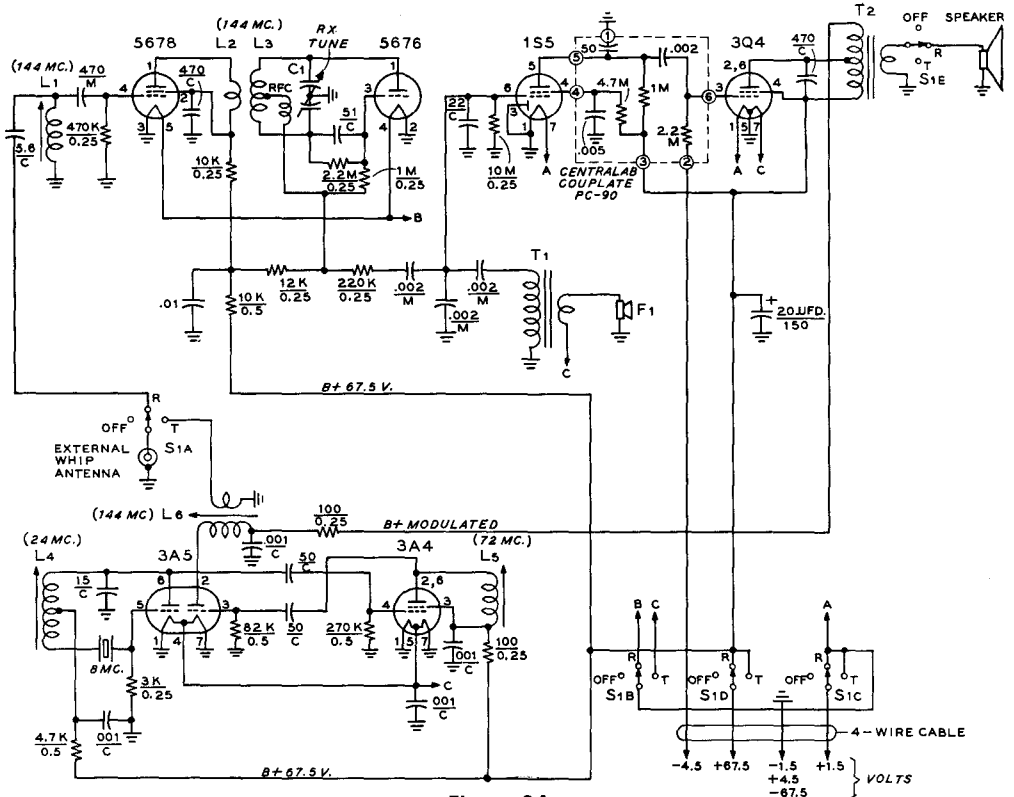

Figure 24
SCHEMATIC, "HANDIE-TALKIE" FOR 2 METERS
 Coil data is given in Figure 26.
 C₁₁—11 µfd. "butterfly", Johnson 3MB11
 S₁A-B-C-D-E—5 pole, three position rotary switch. Centralab PA-2015
 T₁—100 ohms to grid. Triad A-1X
 T₂—5 K pri., 6.7 K and 4 ohm sec. Triad M-4Z
 F₁—Telephone-type carbon microphone.

through which the transmitter tuning slugs may be adjusted. These holes are closed with snap-in hole plugs after adjustments are completed.

A general view of the transmitter chassis may be seen in figures 25, 27, and 28. Notice that a small shield passes across the r-f stage tube socket, and pin 3 of the socket is grounded to the shield. The shield isolates coil L_1 from tuning capacitor C_1 which is placed directly below it. The two audio stages and transformer T_1 mount at the end of the chassis. The tubes mount parallel to the front panel on a small aluminum angle bracket. Directly below T_1 is the 5676 detector tube, also placed in a horizontal position.

The crystal socket, the transmitter coils, the two r-f tubes, and the "send-receive" switch S_1 are mounted at the far end of the chassis. A small shield plate is placed between coils L_4 and L_5 to reduce interstage feedback. Output transformer T_2 is located between the 3A4 plate coil (L_5) and the audio tubes.

The r-f stage coil L_1 is wound upon a slug-tuned form made from a concentric trimmer capacitor. The outer electrode of the capacitor is removed, exposing the polystyrene form upon which the coil may be wound. The inner slug of the capacitor serves as the tuning slug of the coil.

FIGURE 26—COIL TABLE FOR "HANDIE-TALKIE"

L1	— 5 TURNS N° 16 E. (SEE TEXT)
L2	— 2 TURNS N° 22 INSULATED WIRE COUPLED TO GRID END OF COIL L3.
L3	— 5 TURNS N° 16 E., 3/8-INCH DIAMETER, 1/2-INCH LONG, AIR WOUND.
L4	— 20 TURNS N° 26 E., 1/2-INCH DIAMETER, 1/2-INCH LONG. TAP 9 TURNS FROM GRID END. RESONATES IN CIRCUIT AT 24 MC.
L5	— 7 TURNS N° 16 E., 3/8-INCH DIAMETER, 1/2-IN. LONG. RESONATES IN CIRCUIT AT 72 MC.
L6	— 5 TURNS N° 16 E., 3/8-INCH DIAMETER, 1/2-IN. LONG. RESONATES IN CIRCUIT AT 144 MC.

Transceiver Wiring

Wiring techniques are extremely important when working on VHF equipment that must be compacted into a small space. It is recommended that a "pencil-type" soldering iron be used, along with small gage wire whose insulation will not melt if it is overheated. All socket grounds and filament wiring are completed first. Coils are wound and put into position. After the coupling capacitors and other r-f components are mounted in place, the tubes are placed in the sockets and the tuned circuits are adjusted to frequency. It may be necessary to alter the number of turns on coils L_1 , L_3 , L_5 , and L_6 due to slight variances in circuit components and tube inter-electrode capacities.

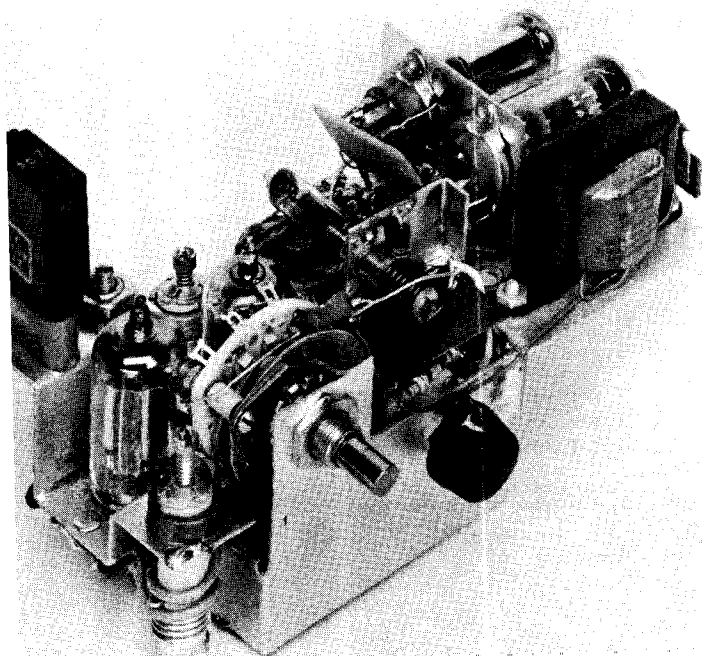
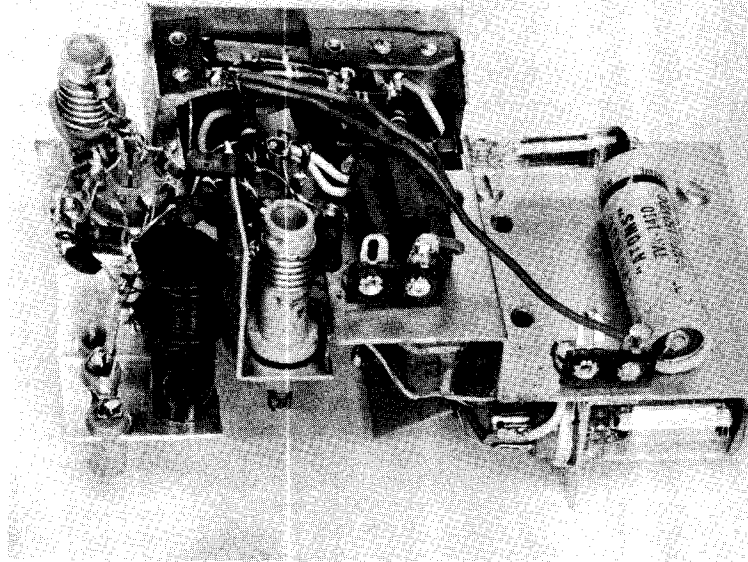

Figure 25
VIEW OF
"WALKIE-TALKIE"
CHASSIS SHOWING
MAJOR
COMPONENTS

Oblique view of chassis looking towards switch S_1 . Output coil L_5 is in foreground with 3A5 tube behind it. To right of 3A5 is 3A4 tripler stage. Coils L_1 and L_2 are behind 3A4. To right of switch S_1 is receiver tuning control C_1 . Shield separates C_1 from coil L_1 directly above it. R-f amplifier tube 5687 mounts on vertical plate supporting L_1 . Shield below r-f tube isolates it from detector components below the chassis. Audio tubes are at right, with T_1 .

Figure 27
UNDER-CHASSIS
VIEW OF
WALKIE-TALKIE
SHOWING MAJOR
COMPONENTS

Chassis of transceiver is specially bent to fit components in smallest possible space. Oscillator coil L_1 is at left separated from tripler coil L_2 by small shield. Output coil L_3 is to rear. 5676 detector tube is at right rear, flanked by 20 μ f. filter capacitor. Audio tubes are under chassis partition at right. Quench filter capacitors are to right of coil L_1 .



These adjustments may be done quickly and easily with the aid of a grid dip oscillator.

After the r-f circuits are adjusted the rest of the transceiver may be wired. Short, direct leads should be used in the r-f circuits and all wires should be routed in the shortest possible paths.

Transceiver Alignment After all wiring has been checked, the tubes should be removed from their sockets and the filament batteries connected to the unit. The filament voltage at each tube socket should be checked in all three operating positions of switch S_1 . Make sure the second filament section of the 3Q4 (pin #7) is energized in the "transmit" position of S_1 . The bias batteries and B-plus batteries may now be attached to the proper leads. Be sure of the correct battery polarity before inserting the tubes in the sockets. Test the "handie-talkie" for proper reception first. The slug of coil L_1 should be adjust-

ed for best reception after the transceiver is assembled and the whip antenna placed in the coaxial receptacle. However, it is possible to place a short piece of wire in the antenna receptacle to pick up a test signal while the transceiver is dissembled on the bench. The coupling between L_2 and L_3 should be adjusted for best super-regenerative action and sensitivity.

After the receiver is operating, the transmitter should be energized. Tune the slug of coil L_1 for reliable crystal operation. A grid dip oscillator held in the proximity of L_1 will serve as a r-f indicator. Remove the plate voltage from the grid dip oscillator for this test. Alternatively, oscillator operation may be monitored in a nearby receiver tuned to the 24 Mc. overtone frequency of the crystal. The 3A4 tripler stage may now be tuned for maximum output on 72 Mc. as indicated on the grid dip oscillator. Finally, the grid dip oscillator (or wavemeter) is held in close proximity

Figure 28
TRANSCEIVER
CHASSIS BOLTED
TO PANEL OF
WALKIE-TALKIE

The chassis is held in place by bolts passed through frame of small speaker. Modulation transformer T_2 is visible in foreground with Centralab "Couplate" at rear of audio tube sockets. Batteries occupy space to left above microphone. Crystal socket is at far right, which is "top" end of transceiver.

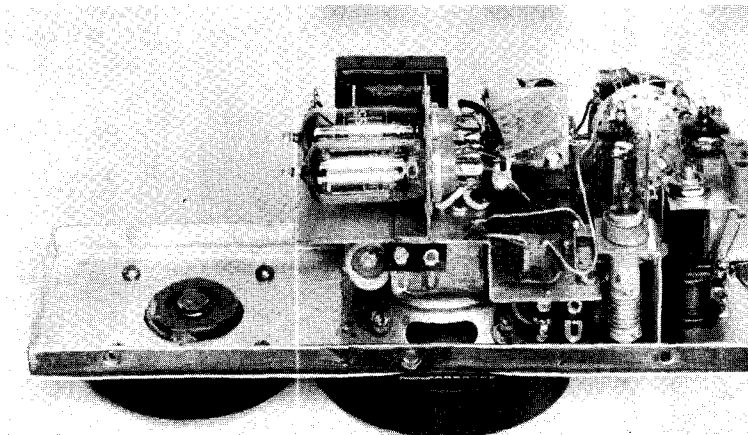

to the 144 Mc. doubler plate coil, L₆. This coil is tuned for maximum output at 2 meters. After this preliminary alignment is completed the chassis of the transceiver may be placed in the case, along with the battery power pack.

Final Alignment Experience with several of these units has shown that maximum output is obtained with a whip antenna slightly longer than quarter wavelength. The transmitter stages should be retuned for maximum field strength in a nearby wavemeter and different length whip antennas should be tried. The quarter wavelength whip is nineteen inches long, but whip lengths up to twenty-seven inches should be tried. In general, whip lengths of twenty-four inches or so seem to produce best results with this little transceiver. Input to the final stage of the 3A5 is approximately ½-watt under optimum loading conditions.

The operating range between two of these units varies from a thousand feet or so over obstructed terrain to better than three miles over smooth ground. Communication between the "handie-talkie" and a base station equipped with a sensitive receiver and a high gain beam can be maintained over greater range.

27-6 Six Meter Transceiver for Home or Car

The six meter band has become extremely popular within the past few years. The pinnacle of the sunspot cycle, combined with the influx of new amateurs has brought life to an otherwise neglected amateur band. Most of the stations operating on this band employ

relatively low power and the amateur having modest power suffers no handicap if he has a good antenna.

The growth of mobile operation on the six meter band has been rapid and the need has arisen for a compact transceiver that will work well either in the car or at home. The unit described in this section has been designed to meet this need.

This compact transceiver operates in the 50-54 Mc. range. It employs a stable, superheterodyne type receiver and a 10 watt transmitter. The transmitter may be either crystal controlled, or driven with an external variable frequency oscillator. A 5-watt audio system operates from a high impedance crystal microphone and provides 100% modulation of the transmitter. In the receiver mode, the audio system delivers sufficient power to drive an external speaker well above the noise level of the automobile.

Small enough to fit comfortably under the dash of today's car, the transceiver delivers a well modulated signal at a total plate power drain of 100 milliamperes at 250 volts potential. Voltage regulation of the plate and filament voltages of the receiver oscillator ensures the maximum stability required for mobile work.

Transceiver Circuit A block diagram of the transceiver is shown in figure 30.

Eleven tubes are employed, plus a filament voltage regulator. Change-over from receive to transmit is accomplished by a push-to-talk circuit that operates two d-c relays from the microphone control button.

The receiver employs a broad-band r-f stage and two i-f stages. The r-f stage uses a 6CB6 television-type pentode with pre-tuned grid and plate circuits. This stage is capacity coupled to a second 6CB6 mixer operating with grid injection. The variable frequency oscillator is a third 6CB6 in a Tri-tet configuration. The oscillator circuit (L₃-C₃-C₄) tunes the 17.0-17.7 Mc. range. The plate circuit of this



Figure 29

DE-LUXE SIX METER TRANSCEIVER FOR HOME OR CAR

Operating from a separate power package, this compact transceiver is well suited for the serious six meter operator. A 10 watt crystal controlled transmitter and superheterodyne receiver are combined with a dual purpose audio system in this small cabinet. Receiver controls are at left and transmitter controls at right. Meter serves as S-meter and transmitter tuning indicator. External VFO may be used with transceiver.

stage is gang-tuned to the oscillator and covers the third harmonic range of 51-53 Mc. The harmonic voltage is capacitively coupled to the input grid circuit of the mixer stage. Series padding capacitors in the oscillator and tripler stages permit close tracking over the tuning range.

An i-f channel of 1 Mc. is employed in this transceiver. When the oscillator is considered to be on the high frequency side of the received signal, the tuning range is 50-52 Mc. When the oscillator is considered to be on the low frequency side of the received signal, the tuning range is 52-54 Mc. The broad band r-f circuits of the receiver "front end" cover the complete range of 50-54 Mc. so that signals on either side of the injection frequency may be detected. This principle is sometimes referred to as *super-imposition tuning*, wherein the receiver is tuned to two frequencies simultaneously. For example, if the local oscillator is tuned to 51 Mc., simultaneous reception of signals on 50 Mc. and 52 Mc. is possible. Since most amateur activity takes place in the lower one megacycle of the six meter band, the chance of two signals appearing at one point of the dial that in reality are two megacycles apart is remote.

Super-imposition tuning greatly simplifies the design of a VHF receiver. Double conversion is not required, and the local oscillator need tune only a relatively narrow frequency range. Saving, in parts and circuit complexity, is obvious.

Two stages of one megacycle i-f amplification are used for maximum gain. Five i-f transformers are used to narrow the "skirt" response of the i-f strip. A 12AL5 serves as the detector, a-v-c rectifier, and automatic noise limiter. Filament voltage to the 12AL5 is reduced to 10.5 volts to provide better noise limiting action.

Two tubes are used in the audio system of the transceiver. A 12AX7 dual triode serves as a two stage resistance coupled speech amplifier. Only one section of the 12AX7 is used for reception purposes. The dual triode is capacity coupled to a 12AQ5 audio output stage. A tapped output transformer matches the 12AQ5 to the r-f amplifier plate circuit of the transmitter section, and a low impedance winding on the transformer drives an external speaker for reception. The screen voltage of the 12AQ5 is reduced for receiving operation to conserve power supply drain.

The transmitter section of the transceiver uses two pentode tubes. The oscillator is a 6CL6 in a "hot cathode" circuit employing 25 Mc. overtone crystals. Switch S₂ in the grid circuit of the oscillator permits selection of an external variable frequency oscillator. The plate circuit of the oscillator (C_s-L_s) is tuned to the 50 Mc. second harmonic of the crystal. A switch (S₁) in the oscillator screen circuit permits the operator to turn on the oscillator stage during reception for "zero-beat" or frequency marking purposes. The oscillator is inductively coupled to a 5763 r-f amplifier

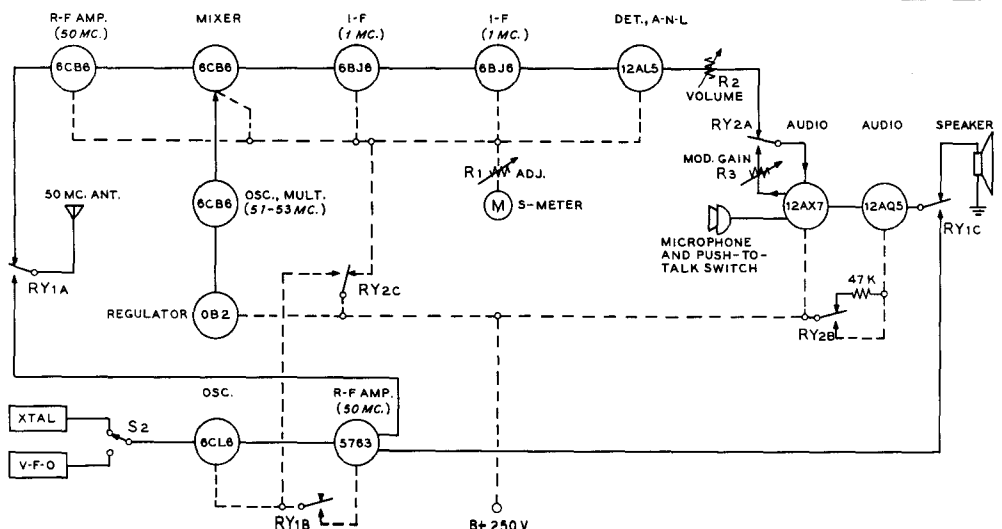

Figure 30
BLOCK DIAGRAM OF 10 WATT SIX METER TRANSCEIVER

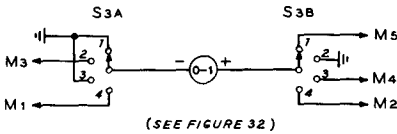
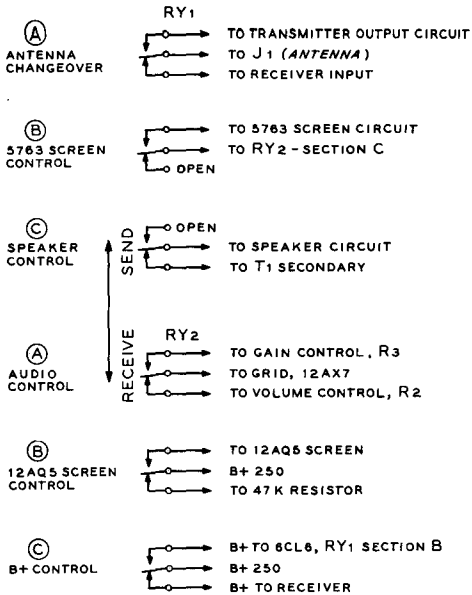

Figure 31
RELAY AND METER CIRCUITS
Relays are shown in unenergized position.

stage, which is plate modulated by the 12AQ5 audio amplifier. The r-f amplifier is bridge neutralized by capacitor C_{10} for greatest stability at the operating frequency range. The plate circuit of the 5763 is pi-coupled to a 52- or 72-ohm external load.

Transfer from reception to transmission is accomplished by means of two d-c relays actuated by a push-to-talk switch in the microphone. The six volt relay coils are connected in series for twelve volt operation. Relay change-over operation is shown in figure 31. Relay RY-1 actuates antenna changeover, screen control, and speaker control circuits. Relay RY-2 actuates audio control, 12AQ5 screen control, and B-plus control circuits. Both relays are shown in "receive" position in figures 31 and 32.

Proper tuning of the r-f amplifier is accomplished by a simple crystal diode voltmeter (1N38A) connected in the antenna circuit.

The stage is tuned for maximum reading of the voltmeter.

A two pole, four position rotary switch (S_2) serves to place the 0-1 d-c milliammeter across the appropriate circuits in the transceiver. In position 1 (M_5) the meter serves as a 0-500 volt meter measuring the transceiver plate voltage. Position 2 (M_3) converts the meter into a 0-10 d-c milliammeter measuring power amplifier grid current. Position 3 (M_1) monitors the r-f voltmeter output, and position 4 (M_1, M_2) places the meter in the a-v-c controlled B-plus line of the receiver where it serves as a signal strength meter.

Under normal driving and charging conditions, the voltage of the standard "12 volt" battery can vary from 11 volts to 14.5 volts. This fluctuation can raise havoc with the receiver oscillator stability. It is annoying, to say the least, to have the receiver calibration change with variations of car speed and generator voltage. To eliminate this effect, an *Amperite* ballast tube (R_4) is placed in series with the filament circuit of the 6CB6 receiver oscillator tube. This current sensitive device compensates for voltage changes in the filament circuit, holding the voltage at the filament terminals of the oscillator tube within a few percent of a nominal 6.3 volts.

The six volt tubes of the receiver are connected in series parallel for operation across the 12-volt power supply. A compensating resistor is required across the filament of the 5763 to equalize the current drain with that of the 6CL6 oscillator.

Transceiver Layout and Assembly Figures 29, 33, and 34 provide a general layout of the transceiver.

The unit is built upon an aluminum chassis measuring 9" x 7" x 1½" in size. This assembly fits within a steel wrap-around type cabinet 4½" high, and approximately the same length and depth. The cabinet is formed of perforated metal to ensure proper ventilation while at the same time reducing spurious radiation to a minimum.

Viewed from the top rear (figure 33), the receiver portion of the unit occupies the right half of the chassis and the transmitter and modulator occupy the left half. The external plugs and receptacles are mounted on the rear apron of the chassis as is the modulation gain control, R_3 . These components project through a cut-out in the rear of the steel enclosure. All the ceramic variable capacitors that serve as circuit adjustment trimmers are flush

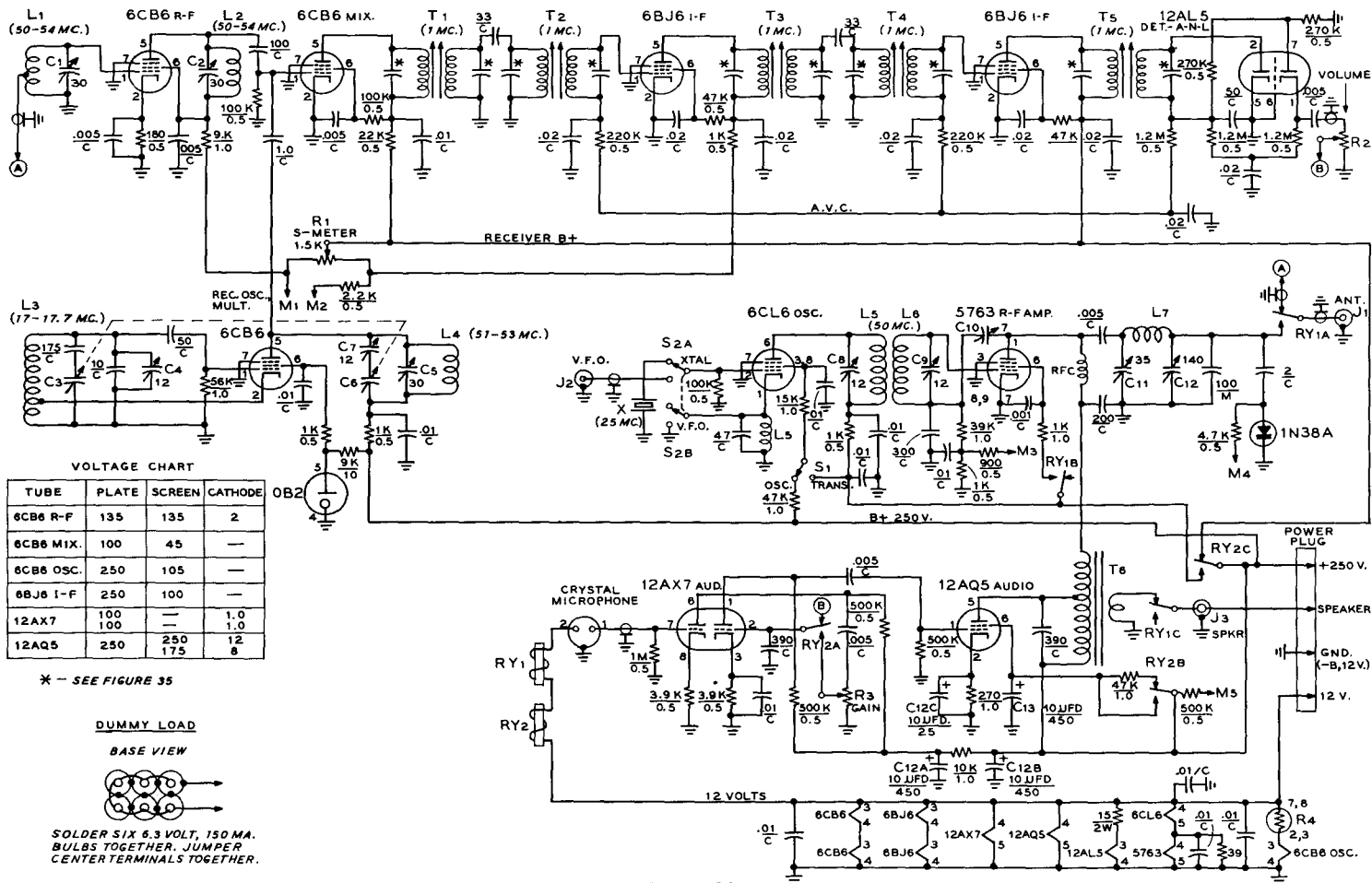

Figure 32
SCHEMATIC, SIX METER TRANSCEIVER

Coil data and i-f transformer modification is given in figure 35. Relay and meter connections are given in figure 31.

C₁-C₃-C₅—6-30 μ fd. Centralab 827C
 C₄-C₇-S₂-C₈—3-12 μ fd. Centralab 827B
 C₉-C₆—15 μ fd. per section. All-Star Products Co., Defiance, Ohio. Model C3
 C₁₀—7 μ fd. variable "piston-type". Erie 532B
 C₁₁—2E μ fd. Hammarlund HF-35

RY₁, RY₂—3 pole, double throw with 6.3 volt d-c coil. Advance #MG-3C6VA
 T₁-T₅—1500 kc. i-f transformer. J. W. Miller Co. 12-W1
 (see figure 35 for modification)
 T₆—5 K pri., 6.7 K sec., and 4 ohm winding. Triad M5-Z
 R₁—Amperite Ballast Tube #3TF-4A
 Antenna and speaker—California Chassis Co. #LTC-464

mounted to the chassis and may be tuned from the top of the unit, with the exception of the receiver oscillator trimmer C_7 which is mounted below chassis to conserve space.

Below the chassis, a small aluminum shield measuring $1\frac{1}{2}$ " long and $1\frac{1}{4}$ " high is positioned between the oscillator output coil L_1 and the receiver r-f amplifier plate coil L_2 . This is the only interstage shield required in the transceiver. The two transfer relays RY-1 and RY-2 are mounted in the under-chassis area beneath the modulation transformer T_6 . Between the relays is placed an 8-terminal phenolic mounting strip. To the side of this strip is placed the midget S-meter potentiometer R_1 . All sockets and trimming capacitors are mounted in place using 4-40 hardware with soldering lugs placed beneath the nuts in various convenient locations.

Transceiver Wiring The wiring of the unit is quite simple if done in the proper sequence. The underchassis area contains many small components but these need not be crowded, provided proper care is taken in the layout and installation of parts. Be sure the i-f transformers have been modified accord-

ing to the data of figure 35 before wiring is started.

The majority of components are installed between the socket pins of the various tubes and five large phenolic terminal strips. One of these strips (previously mentioned) is placed between the two transfer relays. A four terminal and a six terminal tie-point strip are mounted in line running parallel to the i-f tube sockets of the receiver, towards the chassis-edge side of the sockets. The i-f stage components mount between these tie-points and the pins of the 6BJ6 and 12AL5 tube sockets. A fourth terminal strip (8 tie-points) is parallel to and directly beside the edge of the chassis adjacent to the r-f tube sockets of the receiver. The smaller components of the r-f section mount between this strip and the pins of the 6CB6 sockets.

The r-f coils of the receiver section (L_1 , L_2 , L_3 , and L_4) are mounted directly to the ceramic trimming capacitors associated with each coil. The interstage coupling coils (L_5 and L_6) of the transmitter section are mounted to their respective trimming capacitors and may be seen in the center of the chassis in figure 34.

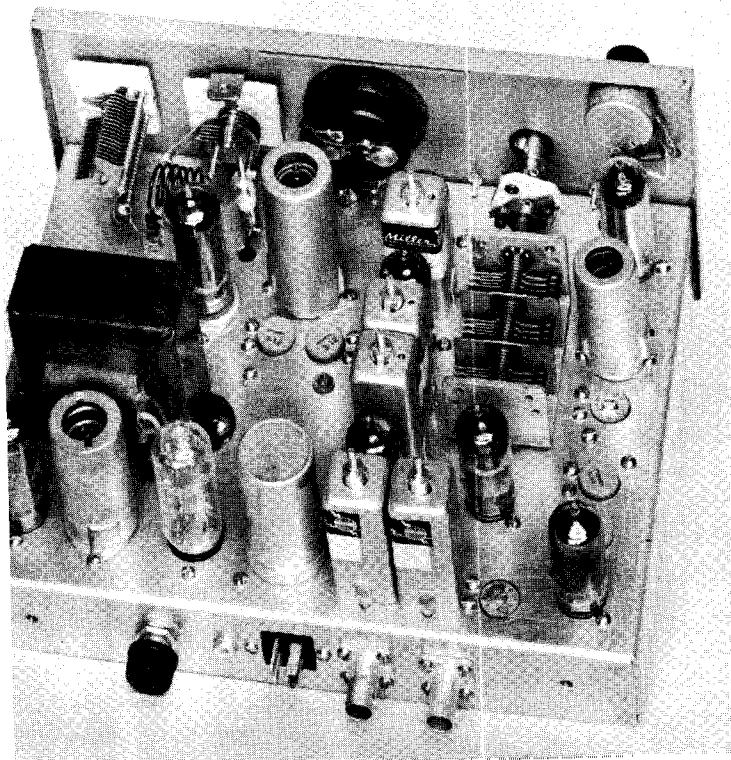

Figure 33
REAR VIEW OF
SIX METER
TRANSCIVER
CHASSIS

Receiver section of unit is at right with trimmer capacitors seen on chassis deck. Center section of three gang variable capacitor is unused. Transmitter output controls are located at upper left. Filament voltage regulator tube is at rear of chassis, just above modulation level control potentiometer. 5763 amplifier tube is behind modulation transformer, with shielded 6CL6 tube to right. I-f strip runs along center of chassis. Antenna and speaker plugs and power receptacle are along rear lip of chassis. Receiver audio control is at upper right of front panel.

After all major components have been mounted to the chassis the various socket ground connections should be made, followed by the filament wiring. The speech amplifier should be wired next, taking care to place small components directly between socket pins to conserve space. All the small components of the i-f system can be mounted above the tube sockets, and in the space between the sockets and the tie-point strips. The power leads from the wired sections of the transceiver should now be run to the two relays.

The next step is to complete the receiver wiring. Shielded leads are run to the volume control R_2 mounted in the upper-left hand corner of the receiver panel (as viewed from the front). The S-meter wiring circuit should be completed as the final wiring step. Note that the case of potentiometer R_1 is "hot" and should be insulated from the chassis with fibre bushings.

Receiver Check-out The receiver may be tested before the transmitter wiring is done. Relays RY-1 and RY-2 are in an unenergized position during reception. Examine both relays to make sure that the back contacts (normally closed) are in good operating condition.

FIGURE 35 COIL TABLE FOR SIX METER TRANSCEIVER	
L1, L2, L4 - 8 TURNS N°18 E., 3/8" DIAM., 1/2" LONG.	
L3 - 7 TURNS N°18 E., 1/2" DIAM., 1/2" LONG. (B&W COIL STOCK)	
L5, L6 - 10 TURNS N°22 E., 5/16" DIAM., 5/16" LONG. ADJUST SPACING BETWEEN COILS FOR MAXIMUM GRID DRIVE. COILS MOUNT END TO END.	
L7 - 6 TURNS N°18 E., 1/2" DIAM., 5/8" LONG. AIRWOUND.	
T1, T5 - REPLACE 100 μ F PD PADDING CAPACITORS WITH 200 μ F PD CAPACITORS TO RESONATE WINDINGS TO 1 MC.	

A power supply capable of delivering 250 volts at 100 milliamperes and 12.6 volts at 3 amperes is required to test the transceiver. A 4-ohm loudspeaker is also required. The receiver is energized and the important voltage points are checked with a high resistance voltmeter and should comply closely with the values of figure 32. When the receiver section is determined to be in operational order, a tone modulated 1 megacycle signal should be loosely coupled to the plate circuit of the 6CB6 mixer tube (pin 5) and the slug cores of all i-f transformers tuned for maximum audio signal. As the stages are brought into resonance, the input signal to the mixer tube should be reduced to prevent over-excitation of the stages.

**Figure 34
UNDER-CHASSIS
VIEW OF
TRANSCEIVER**

Changeover relays are located at the left edge of the chassis. The i-f amplifier runs down the center of the chassis, with the receiver r-f stages to the right. Transmitter stages are located between front relay and i-f strip. Audio stages are placed along rear of chassis. Small components are mounted between socket pins and adjacent phenolic terminal strips.

Note: filament circuit is designed for d.c. operation. If a.c. filament operation is desired, high resistance relay coils operated from the high voltage supply should be employed.

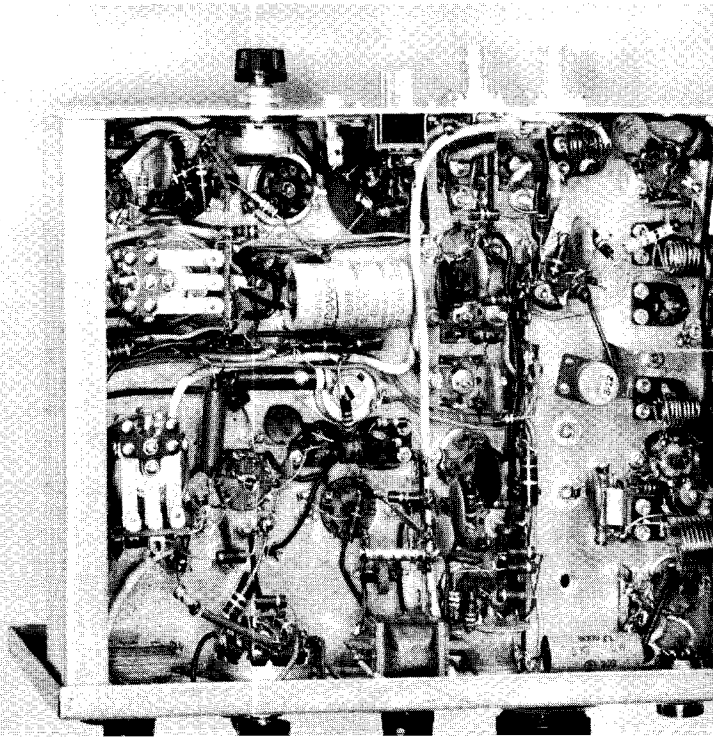

The next step is to check the tuning range of the high frequency oscillator, which should be 17.0—17.7 Mc. The range may be checked with an accurately calibrated receiver or frequency meter. The fixed trimming capacitor determines the overall frequency span of the oscillator, and padding capacitor C_4 determines the range setting. Padding capacitor C_4 is adjusted so that 17.0 Mc. occurs when the main tuning dial is set to five degrees, allowing a slight amount of "overlap" at the band edges. As the main tuning capacitor setting is decreased the oscillator will tune to 17.7 Mc. If it is desired to widen or diminish the tuning range, the value of the series capacitor may be changed slightly. Once the proper oscillator range has been established, the tripler circuit should be adjusted to track with it. The main tuning capacitor should be set to 17.7 Mc. and padding capacitor C_5 adjusted so that the tuned circuit resonates at 53 Mc., as checked with a grid dip oscillator. The main tuning dial is then reset to place the oscillator on 17.0 Mc.; trimming capacitor C_7 is adjusted so that the tripler circuit resonates at 51 Mc. Once the two circuits have been brought into rough alignment they may be placed "on the nose" by adjusting C_7 and C_8 for constant grid current in the mixer stage across the tuning range. Temporarily unsolder the grounded terminal of the 0.1-megohm grid resistor of the 6CB6 mixer tube (pin 1) and place a 0-100 micro-ammeter in series with the resistor to ground. Adjust C_7 at the high frequency end of the tuning dial and C_8 at the low frequency end until the rectified grid current is relatively constant across the band. Under proper operating conditions, the reading should be about 15 microamperes.

The last step is to align the tuned circuits of the r-f stage. These are relatively broad band and need only be peaked over the usual frequency range of operation. For most purposes they should be resonated at 50.5 Mc. for optimum operation at the low frequency end of the band. Signals above 52 Mc. will be slightly attenuated by this adjustment. If operation at the high frequency end of the six meter band is desired, the circuits should be peaked at 53 Mc. with a consequent slight reduction of performance in the 50 Mc. region.

Completion of the Transmitter Section Once the receiver is judged to be in good operating condition, attention should be turned to the transmitter. The lead from the XTAL-VFO switch S_2 to the v-f-o input receptacle J_2 on the rear of the

chassis should be made of coaxial cable, as should the lead from relay RY-1 to the antenna receptacle J_1 . In addition, the lead from the receiver antenna input circuit to relay RY-1 should be shielded.

The majority of small components of both the oscillator and amplifier stages may be mounted by their leads between socket pins and a nearby 5-terminal phenolic tie-point strip. The plate coil L_7 of the 5763 amplifier stage is mounted above chassis, directly behind amplifier tuning capacitors C_{11} and C_{12} . Small *National Co.* polystyrene feed through bushings are used to support the coil. Neutralizing capacitor C_{10} is soldered to a rotor terminal of plate tuning capacitor C_{11} . The lead from C_{10} to the "cold" end of L_6 passes through a $\frac{1}{4}$ -inch hole drilled in the chassis. To insure a good ground return, the rotors of C_{11} and C_{12} are connected to the chassis with a short, heavy copper strap.

The final step is to complete the wiring to the meter switch and the relays as outlined in figure 31. When this is completed, all the transceiver wiring should be completely checked and the chassis thoroughly cleaned of loose bits of solder, wire, etc.

Transmitter Adjustment It is necessary to close both relays to test the transmitter operation. For the time being, they may be wedged close with a bit of matchstick if a 12-volt d-c supply is not readily available. A 25 Mc. crystal should be plugged in the panel holder and switch S_2 set to the XTAL position. Switch S_1 is set to OSC position, and the lead from the screen circuit of the 5763 amplifier tube to the contact of relay RY1-B is temporarily opened, removing screen voltage from the r-f amplifier. Filament and plate voltage is applied to the transceiver and capacitor C_8 is tuned for oscillation of the crystal. The meter of the transceiver is switched to the GRID (M_3) position and capacitor C_9 adjusted for maximum grid current. A reading of half-scale should be obtained. The coupling between L_5 and L_6 can be varied slightly to obtain the proper reading.

The dummy antenna (figure 32) is next plugged into antenna receptacle J_1 and loading capacitor C_{12} set at full capacity. The plate circuit of the amplifier stage should be resonated at 50 Mc. with the aid of a grid dip oscillator coupled to coil L_7 . The turns of L_7 should be adjusted so resonance occurs at half-capacity setting of tuning capacitor C_{11} . After this preliminary adjustment has been made, capacitor C_{11} should be tuned through its range while

carefully noting the grid current of the amplifier. Unless neutralizing capacitor C_{10} has been correctly set by a lucky accident, the grid current reading will show an abrupt kick as capacitor C_{11} is tuned through resonance. The setting of the neutralizing capacitor should be slowly varied so as to minimize the kick of grid current. After change of setting of C_{10} , grid tuning capacitor C_9 should be retuned for maximum grid current. An adjustment of C_{10} will soon be found that will reduce the grid current variation to an imperceptible kick of the meter. When this point is found, the rotor of C_{10} should be fastened in place with a drop of nail polish and the screen lead to RY-1 should be resoldered.

Switch S_1 is now set to the transmit position and power is again applied to the transmitter. The meter switch is placed in the OUTPUT (M_4) position, and plate tuning capacitor C_{11} adjusted for maximum meter reading. At the same time, the bulbs of the dummy antenna should glow. Capacitors C_{11} and C_{12} are touched up for maximum indication of the meter.

In order to test the modulator section of the transmitter when using an a-c filament supply, it is necessary to disconnect the push-to-talk circuit at pin #2 of the microphone plug; otherwise there will be a loud hum on the audio signal. When this is done, the microphone may be plugged into the jack and the gain control (R_3) advanced. The dummy antenna should increase in brilliance under proper modulation. If the coupling to the dummy load is too tight downward modulation will result, and the bulb brilliance will drop. The capacity of loading capacitor C_{12} should be increased, dropping the degree of loading.

The transmitter is designed to operate into a coaxial transmission line having an impedance value between 50 and 75 ohms. When a high value of standing wave ratio exists on the line the impedance presented to the pi-network amplifier may be of such magnitude as to preclude the possibility of a proper match. It is permissible to add a second mica capacitor in parallel with loading capacitor C_{12} to extend the operating range of the pi-network. If more than 50 $\mu\text{mfd.}$ has to be added, the SWR ratio should either be lowered by proper adjustments to the antenna, or the length of the transmission line between the transceiver and antenna should be altered in order to present a more reasonable load to the amplifier circuit. Maximum carrier power output when properly tuned is about $4\frac{1}{2}$ watts.

All r-f adjustments should be carried out with the purpose of obtaining maximum reading on the output meter of the transmitter under a given set of antenna conditions. Under these conditions, maximum transceiver plate current is 100 milliamperes at a plate potential of 250 volts.

The Meter Circuit A final word should be said about the metering circuit of the transceiver. The particular meter used has a d-c resistance of 100 ohms, and a full scale reading of one milliampere. In order to simplify the problem of obtaining meter shunts, the meter is converted into a 0-1 volt-meter by adding a 900 ohm resistor in series with the meter in the grid current position (M_3). The meter is placed across a 1000 ohm shunt in this position. Since the resistance of the meter circuit and the shunt are equal, one-half the grid current flows through the meter, and one-half through the shunt. Thus, when the meter reads full scale (one milliampere), two milliamperes of grid current are flowing in the grid return circuit.

When the meter is switched to S-METER position (M_1, M_2) of switch S_2 , the meter is placed in a bridge circuit, the variable leg of which is the internal resistance of the a-v-c controlled, i-f amplifier tube. The bridge is balanced by proper setting of R_1 ; meter sensitivity is set by the value of the series resistor (2.2K). Dropping the value of this resistance will increase the sensitivity of the meter.

When S_2 is set to the VOLTS position, the meter is placed in series with a 500 K resistor (M_5) and is converted into a 0-500 volt meter to check the operating potential of the plate supply.

27-7 A "Hot" Transceiver for 28 Megacycles

This little transceiver is vivid proof that DX can be easily worked on the 10 meter band. During a test period of two weeks, using a dipole antenna, over 80 foreign phone contacts were made in four continents, including three contacts with India. Power input to the transmitter section of the unit was under 10 watts. Admittedly, such DX is not a daily feature with such low power, but it does prove that a few watts into a well situated antenna can work wonders on the 28 megacycle band.

The 28-10 transceiver (28 megacycles, 10 watts) is designed to operate over the range

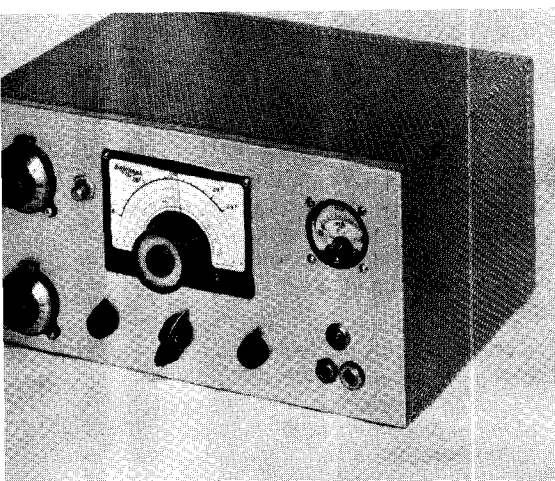

Figure 36
TEN METER TRANSCEIVER HAS
SIMPLE CONTROL PANEL

Used with a dipole antenna, this 10 watt 28 Mc. transceiver has made three contacts with India. Main tuning dial of receiver is at center with send-receive switch below it. At upper right is combination S-meter and transmitter tuning indicator. Transmitter tuning controls are at left with "push-to-zero" switch near receiver tuning dial. Unit features self-contained power supply for 115 volt operation.

of 28.0-29.7 Mc. The receiver portion employs five tubes in a single conversion circuit. Two tubes do double duty as the audio section for reception and the modulator for transmission. Four tubes are used in the r-f section, making a total of eleven tubes plus a voltage regulator. A voltage doubler selenium rectifier supplies plate voltage for the complete transceiver. The whole unit weighs less than eleven pounds so it is readily transportable, even by air. The power source is 115 volts, 50-60 cycles, a-c.

Transceiver Circuit

A block diagram of the transceiver is shown in figure 37. Change-over from receive to transmit is accomplished by a ceramic rotary switch, S₁. The receiver employs one r-f stage and two i-f stages for optimum selectivity and sensitivity. The r-f stage employs a low drain 6BJ6 remote cut-off pentode with tuned grid and tuned plate circuits. The plate of the r-f tube is shunt fed through a 10 K composition resistor and the tuned circuit is placed in the low potential grid circuit of the next stage. A 6U8 is employed here as a combined mixer and oscillator. Grid circuit injection is used. The triode section of the 6U8 serves as the local oscillator, tuning from 26.5-28.2 Mc. for 10 meter coverage. A three section variable capacitor C1A-B-C simultaneously tunes the

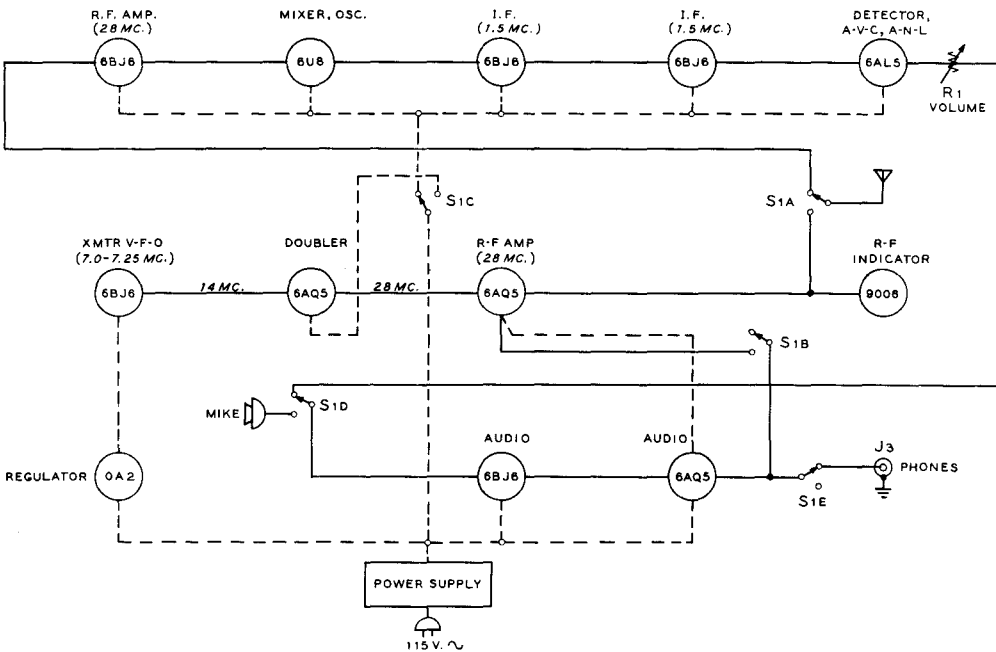

Figure 37
BLOCK DIAGRAM OF TEN METER TRANSCEIVER

r-f, mixer, and oscillator stages. Series padding in the r-f and mixer circuits is employed for good tracking across the band.

An i-f channel of 1.5 Mc. is used in this unit. This particular frequency was chosen to eliminate the troublesome "image" problem, so prevalent on the 10 meter band when the usual 455 kc. i-f channel is employed. Selectivity suffers a bit when the higher frequency channel is used, but a total of eight tuned circuits (four transformers) provide an acceptable passband for voice reception. A 6AL5 double diode serves as the detector, a-v-c rectifier, and automatic noise limiter. The a-n-1 is left in the circuit at all times.

The audio section of the 28-10 uses two tubes. A 6BJ6 serves as a resistance coupled pentode voltage amplifier which is coupled to a 6AQ5 power amplifier. A tapped output transformer matches the 6AQ5 to the r-f amplifier plate circuit of the transmitter section, and a low impedance winding on the transformer matches the audio system to external earphones or speaker. The input circuit of the 6BJ6 forms an R-C dividing network isolating the microphone input from the audio output circuit of the receiver. No switching is required in this circuit.

The transceiver is designed to be used with a low impedance carbon microphone. Voltage for microphone operation is taken from a tap on the cathode circuit of the 6AQ5 amplifier stage. This circuit is broken by switch S1D during reception. At the same time, switch section S1E connects the earphone circuit to the low impedance winding on the output transformer T₅.

Three tubes plus a gas-type voltage regulator and a diode r-f indicator are used in the transmitter portion of the transceiver. A 6BJ6 serves as a "Tri-tet" oscillator covering the range of 7.0-7.25 Mc. The plate circuit is slug-tuned to the 14 Mc. second harmonic. A switch (S₂) in the plate circuit of the oscillator permits the operator to turn on this stage for "zero-beat" or frequency marking purposes. The oscillator is capacitively coupled to a 6AQ5 doubler stage whose plate circuit is tuned to the 28 Mc. region. Switch segment S1C removes the plate voltage from this stage during reception and applies it to the r-f section of the receiver. The plate circuit of the 6AQ5 doubler stage is capacitively coupled to a second 6AQ5 serving as the modulated amplifier. This latter stage is bridge neutralized by capacitor C₅ for stability at the operating frequency. The plate circuit of the amplifier

is a simple pi-network designed to match loads of 50 to 75 ohms. The external antenna is switched between the transmitter and the receiver by means of switch segment S1A. A separate section of the transfer switch (S1B) removes plate voltage from the 6AQ5 r.f. amplifier stage and applies an audio load to the modulator during reception. This auxiliary loading prevents audio feedback when the headphones are removed from the jack J₃, and permits the use of headphones of any impedance to be used without the danger of spurious feedback. The overall gain of the audio system is quite high and it is built in a small space. As a result, it does not have the reserve of stability that would normally be expected. The switching system, too, tends to create small feedback loops that must be carefully controlled. The chief cause of audio instability (or feedback) in this case is due to the close proximity of transformers T₅ and T₆ above the chassis. Feedback can be reduced or enhanced by reversing the polarity of the secondary winding of T₅. The additional audio filtering shown in the schematic of figure 38 reduced this tendency to a minimum. As a final precaution, a small shield (cut from a segment of tin can) was soldered to the top of the core of T₅. The shield projected downwards over the windings of the transformer, as seen in Figure 39. A more expensive solution would have been to employ a shielded transformer in this portion of the circuit. A similar shield is soldered to the core of the filament transformer to reduce hum pickup by the adjacent audio transformers.

The a-c operated power supply employs two "replacement type" selenium rectifiers in a voltage doubling circuit delivering 250 volts at 100 milliamperes. A small filament transformer (T₇) provides 6.3 volts for the tubes and pilot lamp. This particular voltage doubler has the negative side of the high voltage in common with one side of the primary line. As a result, there is a fifty-fifty chance that the chassis of the transceiver will be "above ground" by the amount of the line voltage, which in this case is 115 volts. This can be a lethal situation if permitted to exist. A practical solution is to remove the "ground" side of the transmitter power cable from the usual two wire line, and connect it directly to the external ground, as shown in figure 41. This ensures that the chassis of the transceiver is at ground potential. The "hot" side of the line returns to *one pin* of the line plug. If the plug

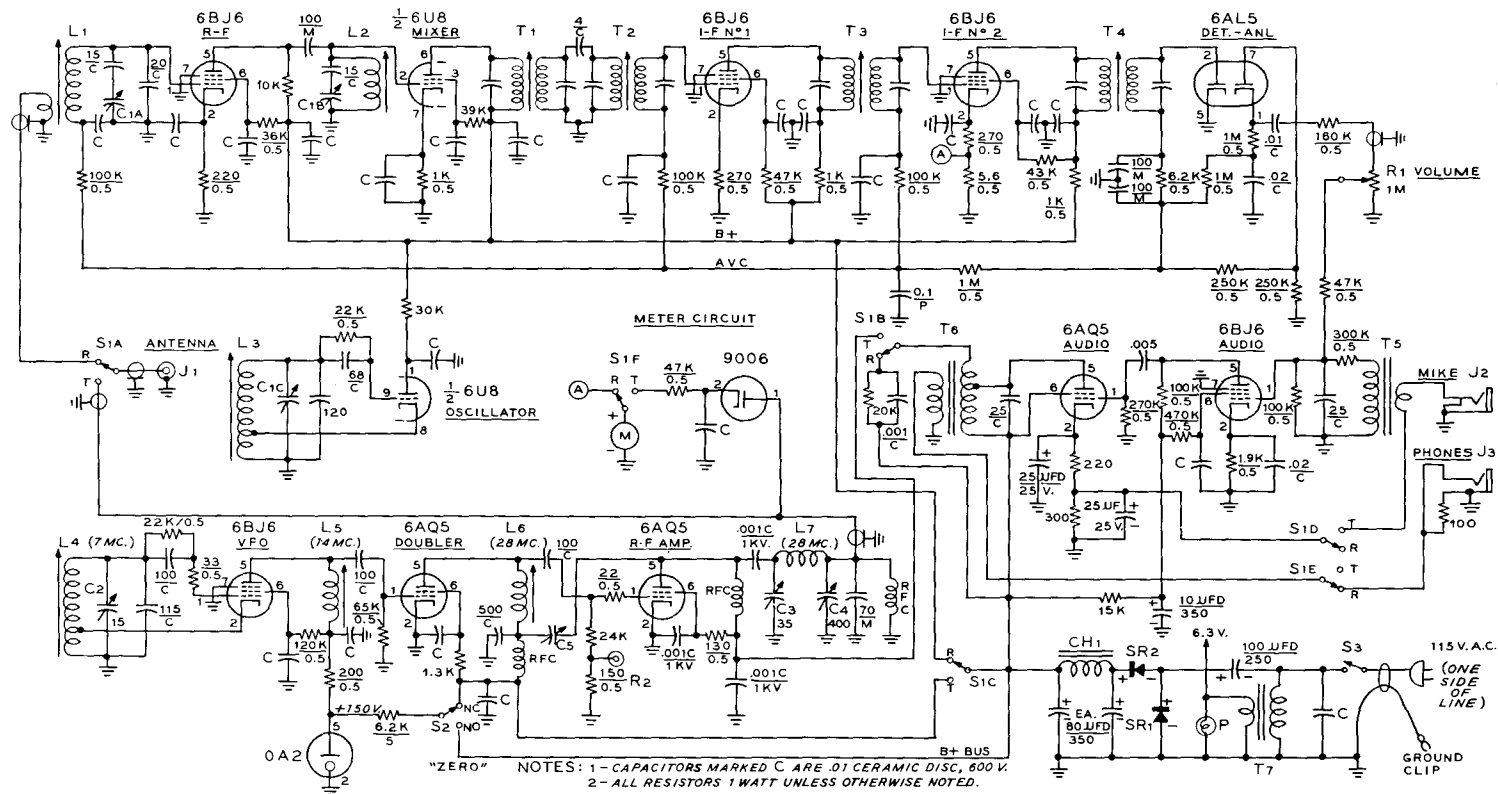

Figure 38A
SCHEMATIC, 10 METER TRANSCEIVER

C—01 μ fd., 600 volt ceramic capacitor. Centralab DD6-103
 C_{1A-B-C}—15 μ fd. per section. All Star Products Co., Defiance, Ohio, Type C3
 C₂—15 μ fd. Bud MC-565
 C₃—30 μ fd. Bud LC-1651
 C₄—400 μ fd. Allied Radio Co., Chicago, Ill. #61H-009
 C₅—7 μ fd. Erie 532B
 CH₁—3 henry at 100 ma. Stancor C-2304

RFC—2½ mh. Millen miniaturized J300-2500
 S_{1A-B-C-D-E-F}—6 pole, two position switch. Centralab PA-2019
 SR₁, SR₂—150 ma. selenium rectifier. Federal 1005
 T₁—T₂—1500 kc. i-f transformer. J. W. Miller Co. 12-W1
 T₃—100 ohms pri. to grid. Triad A-5X
 T₄—5 K pri., 6.7 K and 4 ohm sec. Triad M-4Z
 T₇—6.3 volt, 3 amp. Stancor P-6466
 Chassis and cabinet—California Chassis Co. #LTC-470

FIGURE 38B
COIL TABLE, 10 METER TRANSCEIVER

L1- ANTENNA: 2 TURNS N° 18 INSULATED WIRE AROUND "COLD" END OF L1. GRID: 14 TURNS N° 18 E., 1/4" DIAM., 1/2" LONG. J.W. MILLER 1447-F

L2- 13 TURNS N° 18 E., SAME AS L1

L3- 7 TURNS N° 18 E., SAME AS L1, TAP AT 3 TURNS FROM GROUND END.

L4- 13 TURNS N° 18 E., 3/4" DIAMETER, 1/2" LONG. NATIONAL XR-62 FORM.

L5- J.W. MILLER FORM 1447-F, 1/4" DIAM., 1/2" LONG CLOSEWOUND WITH N° 26 E. FULL LENGTH OF SPACE.

L6- 14 TURNS N° 18 E., SAME AS L1

L7- 7 TURNS N° 18 E., 5/8" DIAM., 3/8" LONG (B&W STOCK)

VOLTAGE MEASUREMENTS			
TUBE	PLATE	SCREEN	CATHODE
6BJ6 R-F	160	150	2.5
6U8 MIX.	260	185	7
6U8 OSC.	100	—	—
6BJ6 I-F'S	185	140	3
6AQ5 AUDIO	260	260	TX-12.5 RX-17

is inserted in a wall socket incorrectly nothing will happen. The transceiver simply refuses to function, and no dangerous situation is created. Simply reversing the plug will energize the circuit, with no danger to the operator. The dual power lead connection, therefore, is a

simple and foolproof system of protection and permits the use of the inexpensive and light weight selenium supply. The only other practical alternative is to employ a power transformer which will add excessive weight and bulk to the package.

Because this hazard exists with any radio equipment of the so-called ac-dc type, many of the newer buildings are being wired with polarized power receptacles having a separate grounding pin. The use of this new wiring technique will help to reduce the inherent "shock potential" of the practical and efficient half-wave rectifier systems, of which this is an example.

Transceiver Layout and Assembly The component placement may be seen in figures 39 and 40.

The 28-10 transceiver is built upon an aluminum chassis measuring 11" x 8 1/2" x 2" in size, and fits within a steel wrap-around type cabinet 5 3/4" high. The cabinet is formed of perforated metal to ensure proper ventilation. Radiation of harmonics from the assembly is reduced to a minimum with this type of enclosure.

Layout of the major components above the chassis may be seen in figure 39. The receiver

Figure 39
REAR VIEW OF
TRANSCEIVER
CHASSIS

Tuning capacitor of variable frequency oscillator is in foreground of photo, panel driven by an extension shaft. To the left of the capacitor is the adjustable slug core of the oscillator coil. Along rear edge of the chassis are the selenium rectifiers, the filament transformer and the high voltage filter capacitor. Transmitter tubes are at right of chassis, with amplifier tube next to panel. At far right is voltage regulator tube. Audio section is at upper left with 9006 diode rectifier in front of the input audio transformer. I-f amplifier is at center chassis, parallel to front panel.

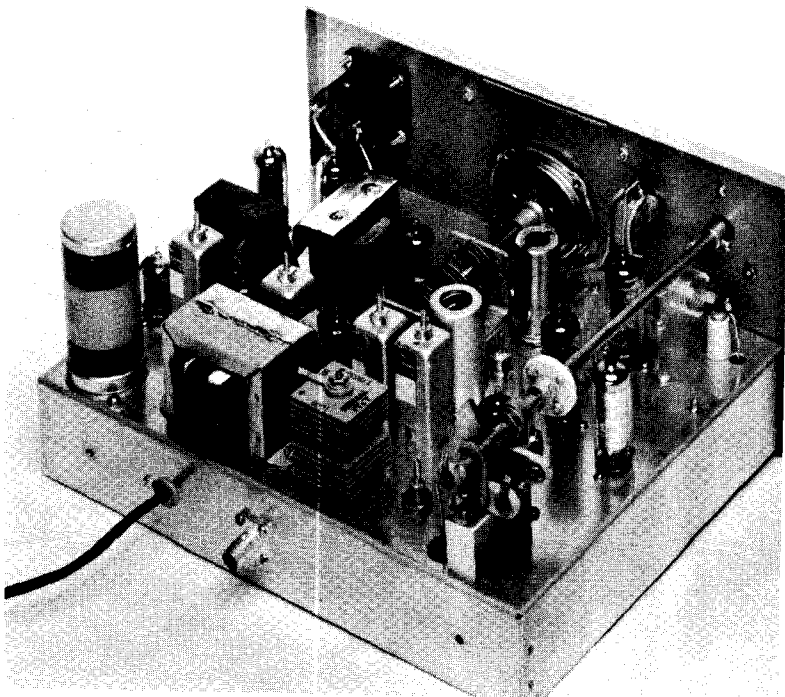

section of the unit occupies the center section of the chassis with the power supply directly behind it. To the right is the transmitter section with the variable frequency oscillator at the rear. Panel control of the oscillator is accomplished by an extension shaft and a flexible coupling. At the left of the chassis is the audio system.

Placement of the main tuning dial is dictated by the height of the three-gang tuning capacitor shaft above the chassis deck. In this case, it is necessary to cut a small notch in the soft aluminum chassis to permit the dial drive assembly to drop low enough to permit the dial shaft to align with the capacitor tuning shaft.

No interstage shields are required below the chassis. Filter choke CH1 mounts at the rear of the chassis, directly below filament transformer T_r . The 100 $\mu\text{fd.}$ filter capacitor mounts to the left wall of the chassis below and to the left of v-f-o tuning capacitor C_s . The three slug-tuned coils of the receiver may be seen in the photograph. Coil L_1 is located behind change-over switch S_1 . Coil L_2 is towards the middle of the chassis, and adjacent to the 10 $\mu\text{fd.}$ audio decoupling capacitor. Coil L_3 is to the left of L_2 and between the r-f tube and mixer tube sockets.

The transmitter oscillator coil L_4 is placed at the left rear corner of the chassis. The adjustable slug of this coil is visible in figure 39 between the selenium rectifiers and tuning capacitor C_s .

To facilitate wiring, four phenolic tie-point terminal strips (six lug type) are placed beneath the chassis. One is located parallel to the edge, just to the left of the 6AQ5 buffer tube socket. A second is placed parallel to the first, to the right of the same socket. The latter strip is used for connections to the r-f circuitry of the receiver section. The third strip is placed parallel to the rear of the chassis just in front of the i-f strip and is used for i-f connections. The last strip is located between the 6AL5 tube socket and the main filter capacitor. The noise limiter and a-v-c components are mounted to this strip.

To secure maximum stability it is necessary to firmly mount the oscillator tuning capacity to the chassis. An aluminum block measuring $1\frac{5}{8}'' \times 1''$ was therefore cut from a section of $\frac{1}{2}$ -inch aluminum stock and used as a support block for capacitor C_s . The capacitor is bolted to the chassis by long 6-32 machine screws which pass through the block and are firmly bolted beneath the chassis.

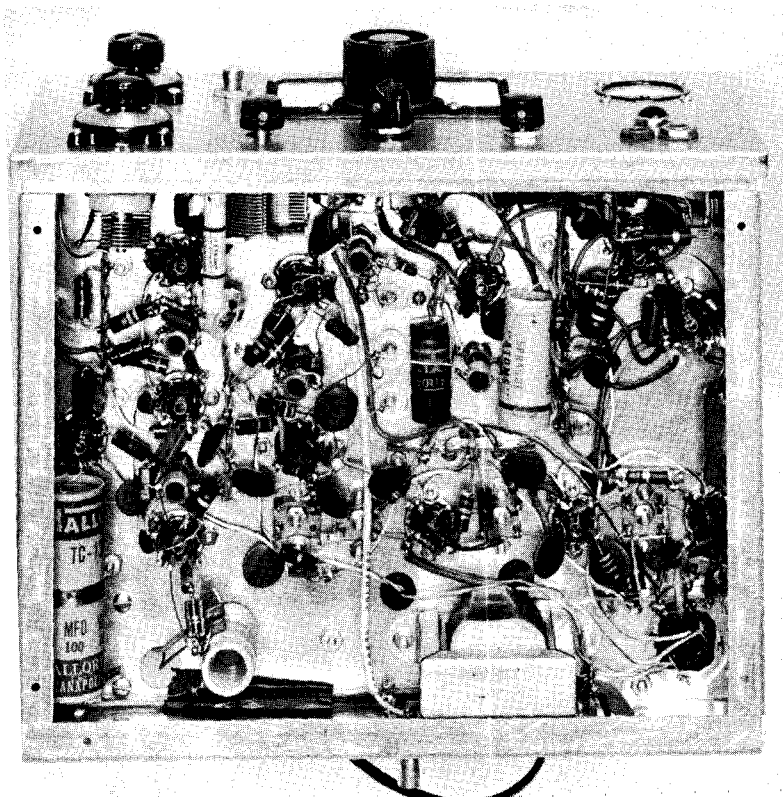

Figure 40
UNDER-CHASSIS
VIEW OF
TEN METER
TRANSCEIVER

The transmitter components are along the left side of the chassis. Receiver components are at the center, with r-f stage nearest the panel. Filter choke is mounted below chassis at rear. Audio stage components are grouped in upper right corner of chassis. See text for placement of the smaller components.

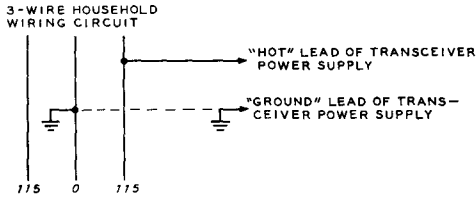

Figure 41
"GROUNDED NEUTRAL"
WIRING SYSTEM

Most dwellings have a three-wire grounded neutral system. 115 volts a-c can be obtained from either side of the system to ground. Separate ground lead on transceiver is always connected before line plug is energized. This eliminates usual "ac-dc" shock hazard.

Transceiver Wiring The sequence of wiring follows much the same pattern as that of the six meter transceiver described in section 27-6. Small components are installed between tube socket pins, or between socket pins and adjacent terminal strip lugs. Socket ground connections are made first and then the filament wiring is completed. The power supply wiring can be done first. When the supply is completed it should be tested. A 2500 ohm, 25-watt resistor should be attached between the output of the supply and ground. A full 250 volts should be developed across this resistor with 115 volts a-c applied to the power supply.

Next, the i-f and second detector section of the receiver should be wired. Short, direct leads and the use of the adjacent terminal strips will reduce crowding in this area. The audio stages should now be wired, along with switch segments S1B, S1D, and S1E. When this is completed, the i-f section and audio of the transceiver may be tested. A test speaker should be connected to jack J₃, and a 1.5 Mc. tone modulated signal from a test oscillator is loosely coupled to the plate pin (#6) of the 6U8 socket. The top and bottom slugs of the i-f transformers are now adjusted for maximum output signal. As the stages approach alignment, be sure to decouple the signal generator to prevent overloading.

After this portion of the transceiver has been tested, the r-f circuits of the receiver should be wired. Coils L₁, L₂, and L₃ are wound and the coil forms clipped in place. The front section of tuning capacitor C1A is employed for the grid circuit of the r-f stage, the middle section is for the interstage r-f circuit, and the rear section is for the oscillator section of the 6U8 tube. Connections between the coils, the

tuning capacitor, and the tube sockets are made with #16 tinned solid wire. In particular, care should be taken to prevent movement of the leads and components in the oscillator section as any minute vibration of this part of the circuit would lead to receiver instability.

Sufficient coupling exists between the wiring of the oscillator and mixer circuits to provide the proper level of injection, and no coupling capacitor is required. The final wiring step is to wind the antenna coil on form L₁. One end is attached to a nearby socket ground lug and the other end goes to the "receive" contact of transfer switch S1A.

When the receiver is completed, a 28.5 Mc. may be injected into the antenna circuit and the main tuning dial set near maximum capacity. The slug of receiver oscillator coil L₃ is now adjusted until the signal is received near a dial setting of thirty degrees. After this, coil L₁ and coil L₂ are peaked for maximum signal strength. Dial calibration should wait until the transmitter section is completed.

Completion of the Transmitter Section The oscillator coil should be wound and mounted in position. The lead from coil L₁ to tuning capacitor C₂ is made of #14 solid copper and passes through a 1/2-inch hole in the chassis. All oscillator components are firmly mounted to reduce vibration to a minimum. Coils L₃ and L₆ are wound and snapped into position as the buffer stage is being wired. The p-a plate coil (L₇) is mounted above chassis between the 6AQ5 amplifier tube and the front panel. The plate (or "hot") end of the coil is supported on a 1/2-inch ceramic insulator and the coil lead passes through a 1/4-inch hole in the chassis to the stator of tuning capacitor C₃, mounted directly below the coil. The opposite end of coil L₇ is attached to a polystyrene feed-through insulator. Neutralizing capacitor C₅ is affixed at one end to a terminal of coil form L₆. The other end attaches to the plate r-f choke, as shown in the under-chassis photograph. The output lead from transfer switch S1A to the antenna receptacle on the rear of the chassis is made from a short length of coaxial cable. When the wiring is completed all connections should be checked and the chassis thoroughly cleaned of solder bits, pieces of wire, flux, etc.

Transmitter Adjustment The 6BJ6 oscillator tube should be placed in the socket, along with the OA2 voltage regulator. Transmitter frequency control capacitor C₂ is set near full setting and the slug of oscillator

coil L_1 is adjusted so as to place the oscillator frequency on 7.1 Mc. The fourth harmonic of the oscillator will then be on 28.4 Mc. At minimum tuning capacitor setting the upper frequency limit of the transmitter will be slightly above 29.7 Mc. The 6AQ5 tubes are now placed in their sockets, and a 0.5 d-c milliammeter is temporarily connected across meter shunt R_2 in the grid circuit of the 6AQ5 final amplifier stage. The screen lead (pin 6) of the 6AQ5 amplifier tube is temporarily opened. Transfer switch S_1 is placed in the "transmit" position and the v-f-o tuning capacitor C_2 is set to 29 Mc. The transmitter is energized and the slugs of oscillator coil L_1 and buffer coil L_2 are adjusted for maximum grid drive to the amplifier (about two milliamperes). Amplifier loading capacitor C_4 is set at full capacity, and tuning capacitor C_3 is tuned through its range while carefully noting the grid current reading. The reading will show an abrupt kick as C_3 is tuned through resonance. Next, the setting of neutralizing capacitor C_5 should be slowly varied by means of a fibre-blade screwdriver so as to minimize the kick of grid current. After each movement of C_5 , the slug of coil L_2 should be reset for maximum grid current. A setting of C_5 can readily be found that will provide a minimum value of grid current change as capacitor C_3 is tuned through resonance. The last step is to resolder the screen lead to pin 6 of the 6AQ5 amplifier tube socket.

Transceiver Operation The transmitter may now be attached to a suitable antenna or dummy load (see section 27-6) for an operative check-out. Receiver calibration should be rechecked, and the dial may be calibrated. The transfer switch should be set to the transmitting position and the transceiver loaded into the antenna system. The meter now indicates the r-f voltage rectified by the 9006 diode attached to the output of the pi-network system. Tuning (C_3) and loading (C_4) should be adjusted to provide a maximum meter reading, with C_3 always being set last for the final "touch up" adjustment. Maximum capacity setting of C_4 provides *minimum* loading and vice-versa.

It may be necessary when working into low impedance loads, or transmission lines having a high value of SWR to parallel loading capacitor C_4 with an auxiliary 100 μ fd. mica capacitor to obtain optimum loading. This will have to be determined by experiment.

A mobile carbon microphone may now be plugged into jack J_2 . An indication of the modulation level can be obtained by noting the increase in brilliance of the lamps of the dummy antenna. Overloading will tend to cause downward modulation. The degree of modulation may be varied by moving the microphone away from the lips. Using a telephone-type *F-1* unit, optimum modulation occurs when speaking in a normal tone about three inches from the microphone. The transceiver output is about six watts fully modulated with a power amplifier input of ten watts.

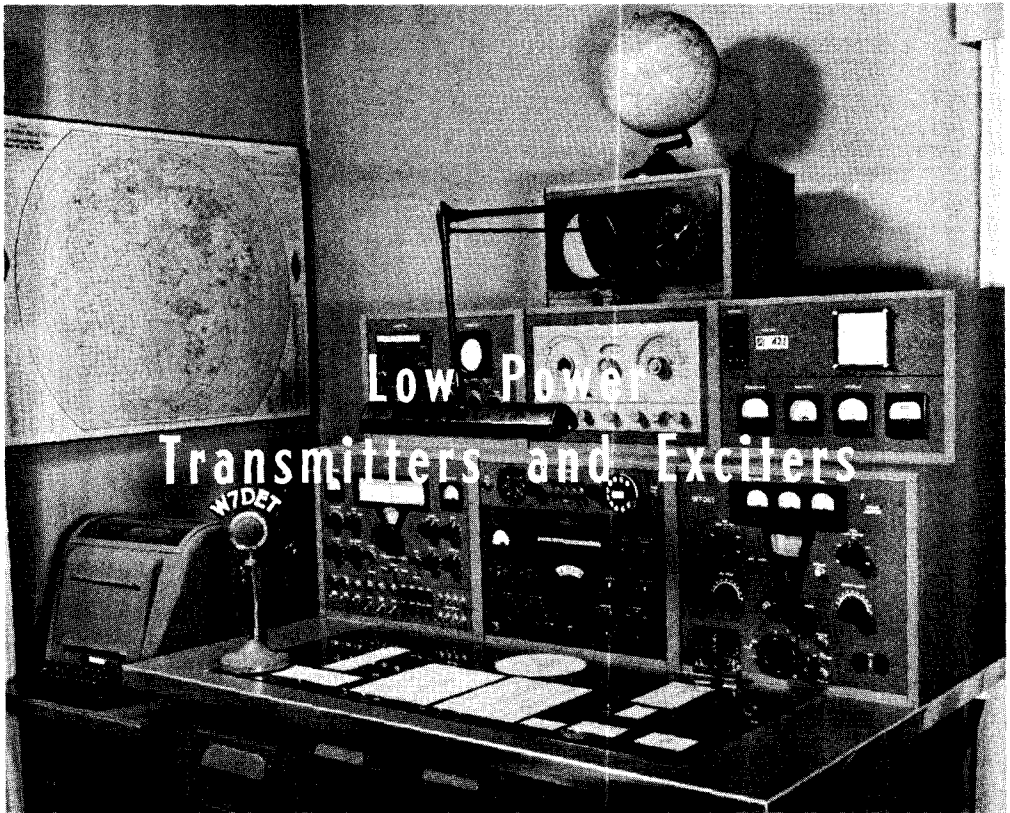

The exciter is the "heart" of the amateur transmitter. Various forms of amplifiers and power supplies may be used in conjunction with basic exciters to form transmitters which will suit almost any need. Of great interest today are simple SSB exciters for fixed and mobile operation. These may be used "as-is" or with a small linear amplifier for mobile work, or may be combined with a high power linear amplifier for fixed station operation. Also occupying a position of importance is the "package" VHF station capable of operation on one or more of the VHF amateur bands.

Several different types of equipment designed to meet a wide range of needs are described in this chapter. There are two different sidband exciters for fixed/mobile service and a de-luxe VHF station capable of outstanding performance on two VHF amateur bands. Also shown is a high stability variable frequency oscillator unit designed for operation in the high frequency DX bands. To the amateur who is interested in the construction phase of

his hobby, these and other units shown in later chapters should offer interesting ideas which might well fit in with the design of his basic transmitting equipment.

As in the previous chapter, the component nomenclature and color codes outlined in figures 1, 2, and 3 of chapter 27 are used in this chapter unless otherwise noted.

28-1 SSB Exciter for Fixed or Mobile Use

The simplest and most economical method of generating a single sideband signal is to employ a phasing-type transmitter of the form outlined in chapter 17 of this Handbook. If the r-f phasing system operates on the carrier frequency of the transmitter the complex frequency conversion circuits may be omitted and the complete exciter becomes inexpensive to build and simple to place in operation.

A SSB exciter suitable for fixed or mobile operation is shown in figures 1 and 4. The exciter delivers a 3 watt peak power signal,

sufficient to drive a high power tetrode linear amplifier to a kilowatt level. Operation is confined to the 80 meter band, although operation on the higher frequency bands is possible with a change of coils, phasing network, and crystal. The r-f phasing circuits are balanced at some frequency within the amateur phone band and will retain a good degree of balance over a frequency range of plus or minus fifty kilocycles of the adjustment frequency.

Circuit Description The circuit of the single sideband exciter is shown in figures 2 and 3. A 12AU7 is employed as a crystal oscillator stage and buffer-amplifier. The first section of the double triode is used in a Pierce oscillator circuit with the crystal connected between the grid and plate of the tube. The oscillator operates directly on the chosen SSB frequency in the 80 meter band. The frequency of oscillation may be varied over a range of two hundred cycles or so by the 50 μmfd trimming capacitor permitting the transmitter to be "zeroed in" on a particular SSB channel. The second section of the 12AU7 serves as an isolation amplifier with the plate circuit tuned to the operating frequency. Changes in the input impedance of the diode modulator stage under operating conditions would cause frequency shift of the oscillator stage if direct coupling between these circuits was used. The isolation afforded by the buffer stage effectively prevents frequency pulling of the oscillator stage during modulation.

The output of the buffer stage is link coupled to a simple 90° r-f phase shift network wherein the audio signal from the audio phasing amplifier is combined with the r-f signals. The network is of the R-C type made up of 50 ohm non-inductive resistors and 800 μmfd . capacitors in a bridge configuration. The reactance of the capacitors is very close to 50

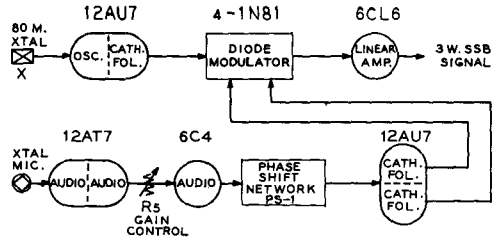

Figure 2
BLOCK DIAGRAM OF PHASING-TYPE
SIDE-BAND EXCITER

Only five tubes are required in this simple phasing-type sideband exciter. Audio system has sufficient gain to operate from crystal microphone.

ohms in the center of the 80 meter phone band. Bridge balance and carrier elimination is achieved by adjustment of the variable potentiometers (R_s , R_a , R_{10}) in the bridge circuit. Four selenium diodes are used in the modulator circuit. A 1N82 multiple diode assembly may be employed, or four 1N81 diodes whose front/back ratios are equal may be used.

The output of the balanced modulator network is coupled by a low impedance link to the grid circuit of a neutralized 6CL6 linear amplifier. This stage operates class AB₁ with cathode bias, delivering a 3 watt peak SSB signal to a low impedance load circuit. All circuits are tuned by adjustable slug-tuned coils (L_1 , L_2 , and L_3).

A cascade 12AU7 and a 6C4 comprise the speech amplifier which may be driven from a crystal microphone. The output of the 6C4 is transformer coupled into the audio phase shift network PS-1. An interstage transformer is connected backwards for T_1 , providing a relatively low impedance secondary winding delivering two equal audio voltages that are 180° out of phase. These voltages are applied to the special audio network whose output circuits drive separate triode sections of the 12AU7 audio phasing amplifier. The 12AU7 tube functions as a dual cathode fol-

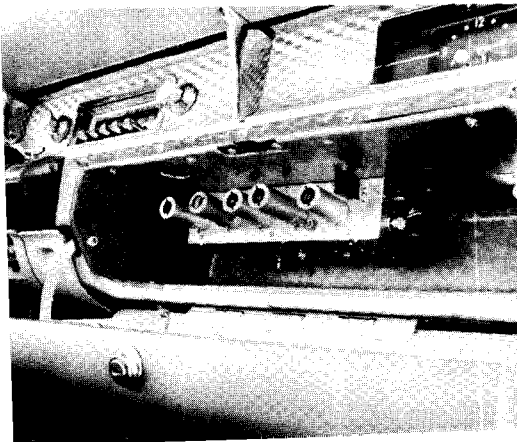

Figure 1
THE GLOVE COMPARTMENT
SIDE-BAND EXCITER

This miniature phasing-type SSB exciter may be mounted in the glove compartment of a car with room to spare! Using only four tubes the exciter delivers a 3 watt peak sideband signal capable of driving a kilowatt tetrode amplifier to full output. The 12AU7 and 6CL6 r-f tubes are at the right end of the chassis, along with the crystal. Major tuning controls are on the right end of the chassis. Entire unit is bolted to the roof of the glove compartment.

lower which provides the necessary low impedance required to match the r-f phasing network.

Sideband switching is accomplished by reversal of polarity of the audio channels by switch S₁. The diode modulator may be unbalanced to pass a carrier for tune-up purposes

by throwing carrier insertion switch S₂ to the right and biasing the diode modulators by means of carrier insertion R_i.

Power requirements for the transmitter are 300 volts at a current drain of 100 milliamperes, and 6.3 volts d-c at 1.85 amperes. When the filaments are connected for 12.6 volt op-

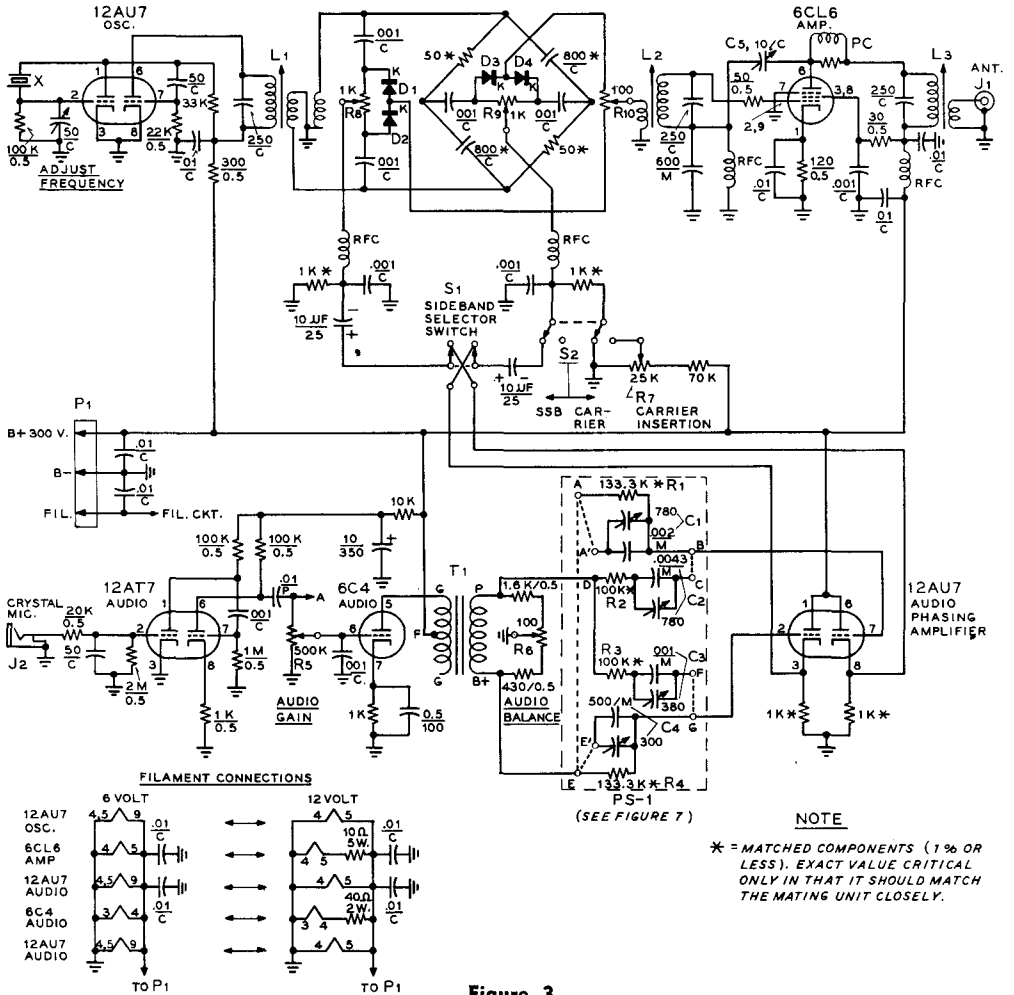

Figure 3
SCHEMATIC DIAGRAM OF FIXED/MOBILE SSB EXCITER

- C₁, C₂, C₃, C₄—See figure 7
- C₅—10 μfd variable ceramic, Centralab 827B.
- R₁, R₂, R₃, R₄—See figure 7
- R₅—500K linear taper potentiometer
- R₆, R₁₀—100 ohm potentiometer
- R₇—25K linear taper potentiometer
- R₈, R₉—1K potentiometer
- PS-1—Phase shift network package. See figure 7
- L₁, L₂, L₃—See figure 8
- T₁—Interstage audio transformer (1:3). Stancor A-53C used backwards.
- RFC—Miniature 2.5 mh. choke. Millen J300-2500
- X—80 meter crystal (3800 - 4000 kc.)
- PC—3 turns #18 e. wire around 50 ohm, 0.5 watt composition resistor.
- D₁-D₄—1N81 diodes; see text.

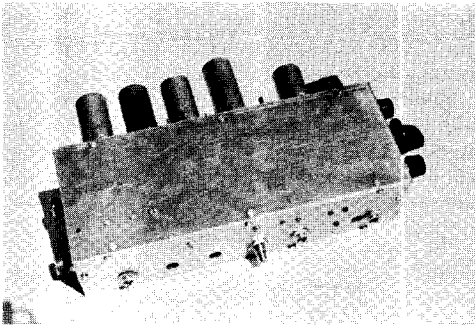

Figure 4
TOP VIEW OF SSB EXCITER

The top plate is removable for easy access to internal wiring and adjustments. Microphone jack and coaxial antenna receptacle are visible at left of chassis. Four control potentiometers are along bottom of box (see text).

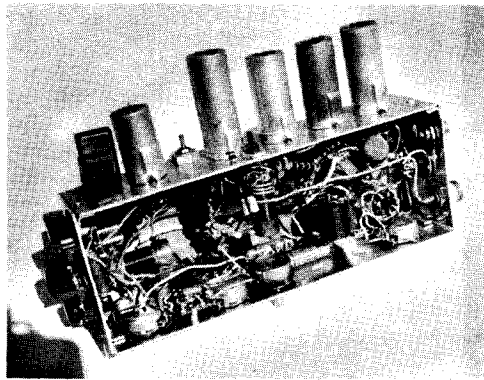

Figure 5
UNDER-CHASSIS VIEW OF SSB EXCITER

Placement of the main components may be seen in this inside view of the chassis. R-f circuitry is at the left with home-made audio phasing network at center, right. R-f modulator potentiometers and germanium diodes in lower left area of the chassis with audio section at right. The 6CL6 linear amplifier plate coil is in the foreground of the center of the chassis.

eration current the current drain is 1.25 amperes.

Transmitter Construction and Wiring The transmitter is constructed upon an aluminum box-chassis measuring 10" x 2½" x 2½" in size. Placement of the major components may be seen in figure 5. The 80 meter crystal and 12AU7 oscillator/buffer tube are positioned at the left end of the chassis, and the 6CL6 linear amplifier is centered on the chassis. The balanced modulator is mounted on a phenolic terminal board on the opposite side of the box. Oscillator tuning controls are placed on the left side of the box-chassis, along with the sideband selector switch S₁, the carrier insertion switch S₂, and the audio gain control R₅. Along the "bottom" of the chassis are placed (left to right) the modulator balance potentiometers R₈, R₉, and R₁₀ and the audio balance control R₆. The carrier insertion potentiometer R₇ is mounted inside the chassis. The three audio stages are mounted on the right-hand section of the chassis.

The components of the audio phasing network PS-1 are mounted on a small phenolic terminal board that may be observed in the lower right corner of the chassis. This network should be wired and tested before it is placed in the transmitter.

The Audio Phasing Network The complete network may be purchased as a finished item (Millen 75012) or it may easily be home built if an audio oscillator and oscilloscope are available for testing purposes.

The circuit of the audio network is shown

in figure 7A. The mounting base may be thin phenolic or any insulating material. The base holds four precision resistors and four fixed mica capacitors padded with four adjustable mica trimmer capacitors. If desired, a series of fixed capacitors may be measured on a capacity bridge and hand picked units chosen to replace the variable capacitors after final adjustments have been completed. This was done with the network shown in the photographs.

The two 100 K series resistors used in the network are *Continental Nobeloy* 1% tolerance precision resistors. The 133.3 K resistors, however, were made by taking two 150 K precision *Continental Nobeloy* resistors and paralleling each of them with a one-half watt 1.2 megohm (plus or minus 10% tolerance) resistor. Careful selection of the 1.2 M units permits close adjustment to the desired target value of 133.3 K. A convenient way to mount the 1.2 M resistors is to slip them inside the hollow body of the precision resistors. The dashed connections should be omitted initially, since the alignment procedure described below presumes that these connections will be made at the proper time only.

Adjustment of the Audio Network If a manufactured network is employed no adjustments are required. However, the home-made network must be aligned before it is placed in the transmitter

chassis. The network resistors should bear the ratio of 133.3 to 100.0, that is, 4 to 3 as closely as can be determined. If in doubt as to the ratio of the resistors you use, double-check their values on an accurate bridge. The adjustment of the phase shift network now consists only of setting the four capacitors to their proper values.

An audio oscillator capable of operation from 225 to 2750 cycles per second (with good waveform) is required, plus an oscilloscope. The oscillator should be carefully calibrated by the method described later. Connect the output of the audio oscillator through a stepdown transformer (T_1 will serve nicely) to a 1 K potentiometer (use R_1) with the arm grounded.

Adjust the arm position so that equal and opposite voltages appear on each half of the potentiometer. A steady audio frequency signal of any convenient frequency may be used with the oscilloscope acting as the voltmeter for this job. Swing the vertical deflection lead of the 'scope from one end of the potentiometer to the other and adjust the arm to obtain equal voltages. Hook up a temporary double cathode follower using a 12AT7 with 500 ohms from each cathode to ground and connect as shown in figure 7B. (It will be convenient to provide leads M, N, and 1 and 2 with clips at the ends to facilitate checking). Cathode pins 8 and 3 of the 12AT7 should connect to the H and V deflection amplifiers in the oscilloscope, and the oscilloscope "ground" connection should be made to the common return of the cathode follower amplifier.

First connect lead M to terminal A on PS-1 and lead N to terminal A'. Connect leads 1 and 2 to terminal M. (Note that the dashed connections are missing at this stage of ad-

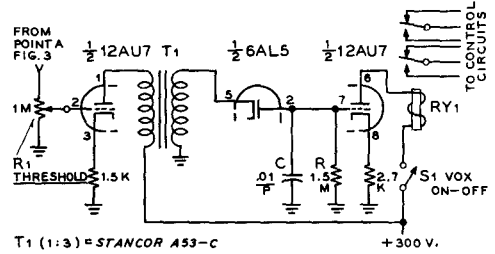

Figure 6
SIMPLE "VOX" CIRCUIT FOR ANY SSB EXCITER

Capacitor C and resistor R determine the "delay time" of the voice operated relay circuit. Operation point is set by potentiometer R_1 . Relay RY_1 has a high resistance d.c. coil (Automatic Electric Co. type R-45L with 10,000 ohm coil may be used).

justment). Adjust the horizontal and vertical gain controls of the oscilloscope to produce a line about 1½ inches long slanted at 45 degrees when the oscillator is set to a frequency of 490 c.p.s. (an exact method of setting frequency will be described later). If the oscilloscope has negligible internal phase shift the display will be a straight line instead of a narrow slanting ellipse. If the latter display appears, it is necessary to correct the oscilloscope phase shift externally by using an adjustable series resistance (a 100 K potentiometer) mounted at either the vertical or horizontal input terminal, depending on what correction is necessary.

The objective here is to obtain a single straight line pattern on the 'scope at an audio frequency of 490 c.p.s. In some cases a series capacitor may be needed in conjunction with the potentiometer to provide the necessary correction. Try values from .05 µfd to .0005 µfd. When the required slanted line is obtained,

PHASE SHIFT NETWORK PS-1

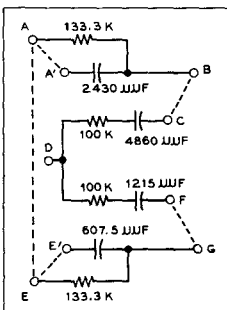

ALL COMPONENTS ± 1% TOLERANCE

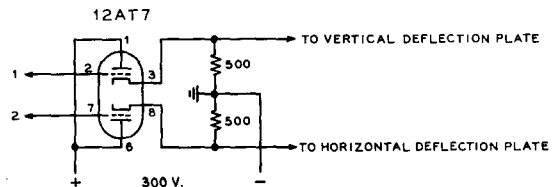
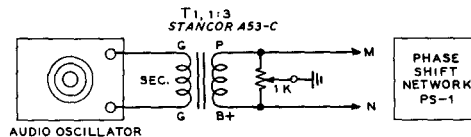
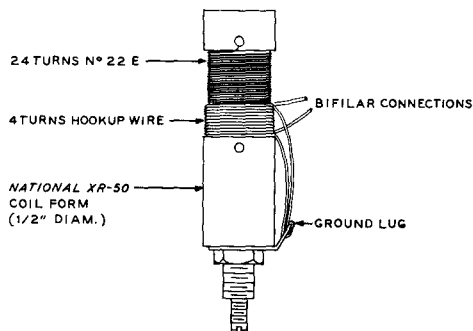

Figure 7

AUDIO PHASE-SHIFT NETWORK AND TEST LAYOUT



NOTE: TWO PARALLEL PIECES OF HOOKUP WIRE ARE WOUND SIMULTANEOUSLY OVER PRIMARY WINDING TO MAKE BIFILAR SECONDARY. BOTTOM END OF ONE WINDING AND TOP END OF OPPOSITE WINDING ARE GROUNDED TO MOUNTING LUG ON COIL FORM.

Figure 8
BIFILAR COIL FOR SSB
TRANSMITTER (L_1)

Coils L_2 and L_3 have 4-turn link coils over bottom end instead of the bifilar winding.

shift lead 1 from terminal A to terminal B on the phase network PS-1. Adjust the trimmer capacitor C_1 (figure 3) to obtain a circle on the oscilloscope. It will be noted as this adjustment is made the display will shift from an ellipse "leaning" to one side through a circle or ellipse (with axes parallel to the deflection axes) to an ellipse which "leans" the other way. If desired, the appropriate gain control on the oscilloscope may be varied so that a circle instead of an "erect" ellipse is obtained at the point of correct adjustment. After checking the gain control on the 'scope, recheck and correct (if necessary) the phase shift in the oscilloscope by moving lead 1 back to terminal A, and then repeat the setting of capacitor C_1 with lead 1 back on terminal B.

In general, always make certain that the oscilloscope is used in a phase-corrected manner. As a double check (if the deflection plates in the oscilloscope are skewed, for instance) connect lead 2 to terminal A'. If the circle changes to a slanting ellipse, readjust C_1 to produce an ellipse "half-way" between the ellipse (obtained by switching lead 2) and a circle. Changing lead 2 from A' to A and back again should give equal and opposite skew to the display when capacitor C_1 is set correctly. Failure to get symmetrical ellipses (egg-shaped, or other display) is due to distortion in the 'scope, the oscillator, the transformer, or the cathode follower. Conduct the test at the lowest signal level possible to avoid distortion.

Next, connect leads M and N to terminals E and E', respectively. Connect leads 1 and 2 to

E, set the oscillator frequency to 1960 c.p.s., correct oscilloscope phase shift as before, and move lead 1 to terminal G. Adjust capacitor C_1 in PS-1 for a circle as was done for C, using the precautions outlined for that case.

Now connect lead M to terminal D, and lead N to terminal F. Connect leads 1 and 2 to terminal D, set the oscillator frequency at 1307 c.p.s., correct oscilloscope phase shift as before, and move lead 1 to the junction of R_3 and C_3 . Adjust capacitor C_3 for a circle on the oscilloscope, as before.

Repeat the above procedure for the remaining R-C pair, R_2 and C_2 . Use terminals D and C at this time and set the oscillator to 326.7 c.p.s. This completes the tests except for a final check to all adjustments. Connect A to A', E to E', B to C, F to G, and A to E. The network PS-1 is now completely wired.

Checking the Audio Network

If the oscilloscope did not require changes in external compensation over the four frequencies used, an over-all frequency check may now be easily made on the phase shift network. To do this, connect lead 1 to point B-C, lead 2 to point F-G, lead M to point A-A'-E-E', and lead N to point D. Now shift the arm of the potentiometer towards M until a circle appears on the oscilloscope screen at a frequency of 250 c.p.s. Then, as the oscillator frequency is varied from 250 c.p.s. to 2500 c.p.s., this circle will wobble a little from one side to the other, passing through a perfect circular display at 440, 1225, and 2500 c.p.s.

The audio band over which the wobble indicates a plus or minus 1.3 degree deviation from true 90 degrees is 225 to 2750 c.p.s., or 12 to 1 in range. This means that when other circuits are properly adjusted, a sideband suppression ratio of 39 decibels is possible at the *worst* points within this range. The average suppression ratio will be about 45 decibels. Proper phase-shift network operation is necessary to obtain this class of performance, so the adjustment procedures have been outlined in detail as an aid toward this goal. The phase shift network should never require readjustment, so that when you are satisfied with the adjustment you may seal the trimmers with cement.

Audio Oscillator Calibration

It will be noted that the frequency ratios are such that the 12th harmonic of 326.7 c.p.s., the 8th harmonic of 490 c.p.s. and the 3rd harmonic of 1306.7 c.p.s. are all the same as the 2nd harmonic of

1960 c.p.s., namely 3920 c.p.s. Thus, if a stable source of 3920 c.p.s. frequency (such as a thoroughly warmed audio oscillator) is used as a reference, the frequency of the test oscillator can be set very closely to one-half, one-third, etc. of the reference frequency if both oscillators feed an oscilloscope and the resulting Lissajous figures observed, as discussed in chapter 9 of this Handbook.

Use of a calibrating frequency in this manner assures that the frequency *ratios* used are correct, even though the exact frequencies used are unknown. The frequency *ratios* (just as the resistance ratio previously mentioned) are far more important that the actual values of frequency (or resistance) used.

Transmitter Wiring The r-f and audio sections of the unit should be wired before the phase network is placed within the chassis. Socket ground connections and filament wiring are done first. The oscillator section should be wired and tested first. The bifilar secondary winding of coil L_1 may be made of two lengths of insulated hookup wire wound over the coil as shown in figure 8.

The germanium diodes in the modulator section deserve special care in handling. Do not bend the leads close to the diode unit itself. The diodes are mounted by means of their leads between the terminals of potentiometers R_8 and R_9 and adjacent tie-point terminals. Protect the diodes from excessive heat while soldering by holding the lead with pliers between the body of the diode and the point where the soldering takes place. Further, use only as much heat as is necessary to make a good joint.

The 50 ohm composition resistors used in the modulator bridge circuit should be a matched pair, measured on an ohmmeter or Wheatstone bridge. In the same fashion the bridge capacitors should be matched as closely as possible to the target value of 800 μmfd .

Both coils L_2 and L_3 of the linear amplifier are mounted beneath the chassis on either side of the 6CL6 tube socket. To reduce coupling between the coils, a shield is placed over coil L_2 . The shield may be made from part of an old i-f transformer can measuring approximately 1" x 1" x 2" in size.

When the transmitter wiring is completed, the audio phase network PS-1 may be placed in the transmitter chassis and wired in place.

Transmitter Adjustment After the wiring has been completed and checked the transmitter is ready for adjustment.

Insert the 12AU7 oscillator/buffer tube in the socket, and plug in a crystal in the range of

3.8-4.0 Mc. Apply plate power and adjust the slug of coil L_1 for maximum signal strength of the oscillator in a nearby receiver. The oscillator should start promptly each time plate voltage is applied to the unit. Frequency of oscillation may be varied over a small range by changing the setting of the crystal tuning capacitor.

The next step is to neutralize the 6CL6 linear amplifier. It is necessary to bypass the diode modulator to do this. Temporarily disconnect one lead of the bifilar link winding on L_1 , and also disconnect the lead between potentiometer R_{10} and amplifier grid coil L_2 . Now, connect the free winding of the bifilar link of L_1 to the ungrounded end of the link of L_2 . This will apply the oscillator signal directly to the linear amplifier. Temporarily load the 6CL6 stage with one or two flashlight bulbs (6.3 volt, 150 ma. — brown bead) connected in parallel at the output jack J_1 . The slugs of coils L_2 and L_3 should be adjusted for maximum amplifier output. The 12AU7 oscillator tube should now be removed from the socket, and unless the setting of neutralizing capacitor C_5 happens by chance to be correct, the flash lamp load will continue to give some indication of output, showing that the 6CL6 amplifier stage is oscillating. Neutralizing capacitor C_5 should be adjusted with the aid of a fibre screwdriver until the bulb goes out. Readjust L_2 and L_3 for maximum bulb indication as the setting of capacitor C_2 is varied. A setting of C_5 will be found at which oscillation will not occur, regardless of the setting of the slugs of coils L_2 and L_3 .

When C_5 is properly adjusted, the 12AU7 tube should be replaced in its socket and coils L_2 and L_3 returned for maximum output. The temporary link connection between L_1 and L_2 should be removed and the diode modulator reconnected into the circuit.

Next, remove the r-f tubes and insert the three audio tubes in their respective sockets. Apply a low level audio signal of 1225 c.p.s. to the microphone jack J_2 of the unit and connect the horizontal deflection terminal of the oscilloscope to a cathode (pin 3) of the 12AU7 audio phasing amplifier, and the vertical deflection terminal to the other cathode (pin 8) after making certain that the 'scope is phase-compensated at the test frequency of 1225 c.p.s. Adjust audio balance control R_6 to produce a circle on the screen. Make this test at as low an audio level as possible.

Now, plug in the r-f tubes and connect the dummy load to the antenna receptacle, J_1 .

Connect the vertical plates of the oscilloscope (no 'scope amplifier used) to the terminals of the dummy load so that the 80 meter signal of the transmitter may be seen on the screen of the 'scope. Deliberately unbalance one of the diode modulators by setting potentiometer R_9 off-center. Adjust amplifier output coil for maximum pattern deflection at any convenient sweep speed. As the pattern grows when L_1 is resonated it may be necessary to reduce modulator unbalance to keep from overloading the output stage or the 'scope. Remove all audio input to the transmitter by adjusting audio gain control R_5 to zero, then by successive adjustments of the modulator balance controls adjust for zero output as seen on the oscilloscope. It will be noted that as the correct point is approached the adjustments will become progressively sharper. Potentiometers R_8 and R_9 should be juggled until the indicated carrier is a minimum. Slight capacity unbalances within the modulator bridge may prevent a perfect minimum from being obtained. It may be necessary to place a small 10 μmfd variable ceramic capacitor from either end of potentiometer R_{10} back to one side of the diode rectifier bank for best attenuation. Good carrier attenuation may finally be achieved by juggling the settings of R_8 , R_9 , and R_{10} , together with the added padding capacitor.

Next, apply a 1225 c.p.s. audio signal and advance gain control R_5 . An r-f envelope should be seen on the screen of the oscilloscope. The percentage of modulation (or ripple) noted on the pattern is an indication of the degree of mis-adjustment of the balancing controls of the unit. The balance potentiometers should now be touched up to produce minimum modulation on the observed carrier. Audio balance control R_6 should also be checked for minimum ripple pattern.

It is a good idea to vary the audio level input to the transmitter to determine the point of overload. This can be seen on the 'scope as the point at which the modulation ripple on the pattern increases sharply as R_5 is advanced. Always make sure that your audio level is set well below this overload point when adjustments are being made. It should be possible to produce a pattern having very little ripple on the observed carrier wave. This completes the adjustments of the transmitter. Carrier insertion for test purposes may be obtained by reversing switch S_2 and adjusting carrier insertion control R_7 .

VOX Circuits

Voice control of the "send-receive" circuits of the

transmitter are desirable for serious sideband work, and are doubly suited for mobile operation, since full attention may be given to road problems. A simple voice control (VOX) circuit suitable for use with this transmitter is shown in figure 6. Connection to the speech amplifier is made at point A of figure 3. The voice signal is amplified by a triode stage and rectified by the 6AL5 diode. The resulting signal is applied to the second half of the triode tube which operates a sensitive relay connected in the plate circuit. The relay contacts operate the changeover circuits of the transmitter. The time delay required to make the transmitter "hang on" between syllables of speech is determined by the R-C network in the grid of the relay control tube. Increasing the size of the capacitor will increase the delay time and vice-versa.

28-2 A Mobile Transistorized SSB Exciter

Power consumption of radio equipment is of paramount importance in mobile systems. Without the addition of auxiliary expensive

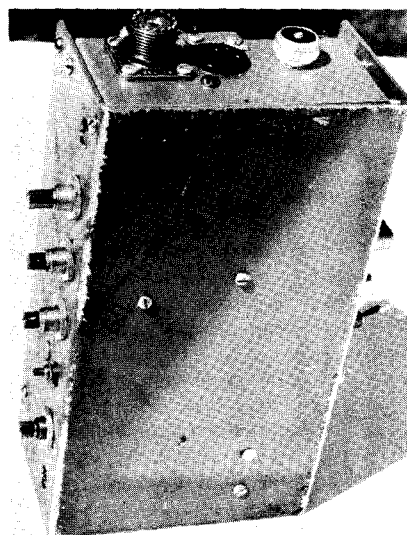

Figure 9
TEN THOUSAND MILES OF QSO'S
HAVE BEEN MADE WITH THIS
TRANSISTORIZED FORTY METER
SSB EXCITER

The reliability of transistorized sideband equipment has been proven with this miniature phasing-type exciter. Overall size is only 7 1/4" x 4" x 2 1/2". Antenna, power, and microphone connectors are on end of chassis and balancing potentiometers and buffer base inductor (L_1) are mounted on side of chassis.

charging components, the usual automotive electrical system is capable of a relatively small additional power drain over and above the standard equipment provided with the car. Single sideband affords an excellent opportunity for the mobile enthusiast to obtain more "talk power" for a given degree of primary power consumption. In addition, if the sideband equipment can be transistorized the power drain will be reduced by a further important amount.

Described in this section is a 40 meter experimental transistorized sideband exciter delivering sufficient output to excite a tetrode linear amplifier to one kilowatt peak input power. The exciter operates directly from the 12 volt ignition system of the car, using five inexpensive transistors, a printed circuit transistor amplifier, and a single vacuum tube. Until a power transistor is developed for r-f

service, it appears that the vacuum tube will still be necessary as a buffer when high frequencies are involved. Power requirements for the exciter are 300 volts at 50 milliamperes, and 12.6 volts at 0.43 amperes.

A new subminiature printed circuit amplifier (*Centralab TA-11*) is used for the speech amplifier. Completely sealed in epoxy resin for protection against mechanical abrasion and humidity, this four stage transistor amplifier provides a gain of over 70 decibels. The complete unit is only 1¼ inches long and less than one inch high.

It is strongly recommended that spare transistors be on hand for substitution in the various circuits. This will give the builder confidence and assurance that each stage is functioning as it should. Many times limitations on performance are imposed by certain transistors without the operator being aware of the con-

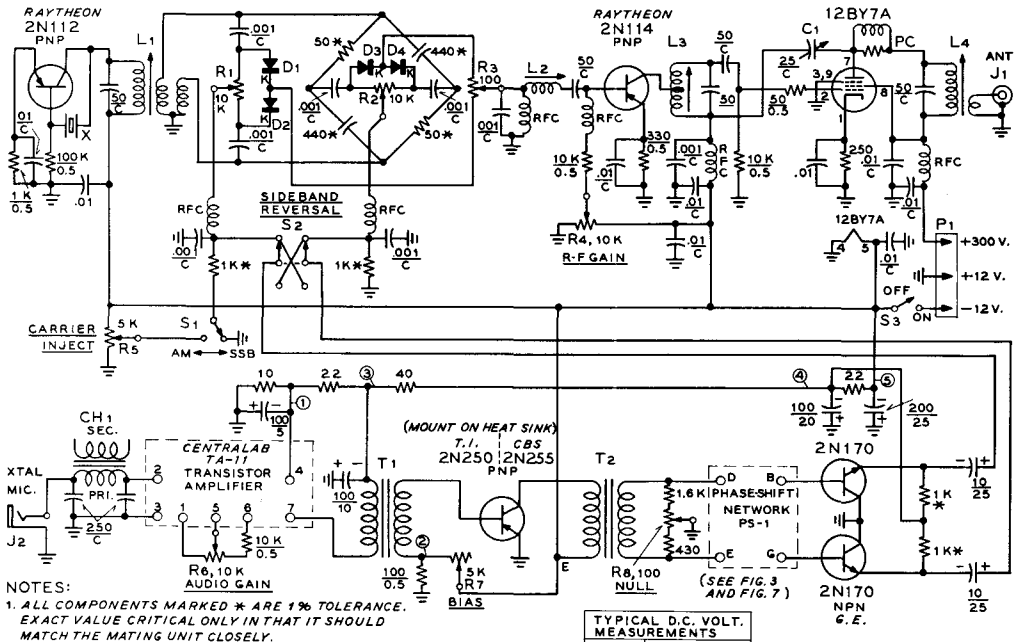

Figure 10

SCHEMATIC OF TRANSISTORIZED FORTY METER SSB EXCITER

- C₁—25µfd. variable ceramic capacitor. Centralab 823-DZ
- L₁—35 turns #22 enamel, ½" diam., closewound on National XR-50 form. Start with two turn bifilar winding (see figure 8, section 28-1 for bifilar detail). Mount coil assembly in small shield can.
- L₂, L₃—Same as L₁. Mount L₂ in small shield can.
- L₄—Same as L₁. Tap 18 turns from "cold" end. Mount in small shield can.
- RFC—2.5 mh. miniature r-f choke. Millen J300 - 2500
- T₁—1K pri., 60 ohm sec. transistor transformer. Chicago UM-111
- T₂—95K sec., 15K pri. (use backwards) UTC-07
- CH₁—200K pri., 1 K sec. transistor transformer. Use primary only. Chicago UM-112
- X—7.2 - 7.3 Mc crystal
- D₁-D₄—Matched 1N81 Diodes; see text.

dition. The concept of transistor action is new and novel to many amateurs; it is not easy to run to the corner radio store and test a transistor to make sure it is operating properly.

Exciter Circuitry The complete schematic of the transistorized exciter is shown in figure 10. It is derived from the vacuum tube exciter circuit of figure 3, section 1, and employs phasing technique on the frequency of operation.

A 2N112 transistor is used as a grounded emitter crystal oscillator employing crystals in the 7.2-7.3 Mc. range. The r-f output is coupled through a tuned circuit and a bifilar winding to the crystal diode balanced modulator. The output in turn drives a 2N114 r-f amplifier stage, operating in grounded emitter configuration. A base bias potentiometer R_4 is included in this stage which permits parameter adjustment for maximum output. The collector of the transistor is tapped at a point on the grid inductor of the linear amplifier stage providing maximum drive without exceeding the transistor ratings.

A 12BY7A is used as the linear amplifier stage. Neutralization is employed for greatest circuit stability, and VHF parasitic oscillations are eliminated by the use of a parasitic suppressor in the plate circuit.

The subminiature transistorized audio amplifier used in this exciter has a rising frequency characteristic that is well suited for SSB work. However, the rising response carries well into the upper audio range wherein the phase shift networks of the PS-1 unit

cease to function properly. It is therefore necessary to incorporate a simple low-pass filter that will substantially eliminate all audio frequencies above 3000 cycles. Such a filter is incorporated in the circuit between the microphone input jack J_2 and the transistorized audio amplifier. The filter consists of the primary winding of a small audio transformer (CH_1) and two 250 μ fd capacitors.

The output signal from the encapsulated transistorized amplifier is transformer coupled to a 2N250 (or a 2N255) power transistor which serves as a driver for the phase shift network. The 2N250 transistor requires a "heat sink" for the collector to allow maximum collector dissipation rating to be achieved. The transistor may therefore be mounted on anodized aluminum discs or mica wafers (supplied by the manufacturer of the transistor), thus insulating the case of the transistor (the collector terminal) from the chassis of the exciter. The phase shift network driven by this transistor is identical to that described in section 28-1 and illustrated in figure 7.

Two 2N170 NPN type transistors are base driven by the phase shift network, and serve as emitter followers, providing a low impedance driving source for the balanced modulator. Sideband selection is accomplished by switch S_2 whose purpose is to reverse the phase of the audio signals applied to the balanced modulator. Carrier injection is accomplished by potentiometer R_5 and switch S_1 which apply conducting bias to the modulator diodes.

A voltage dropping network is employed

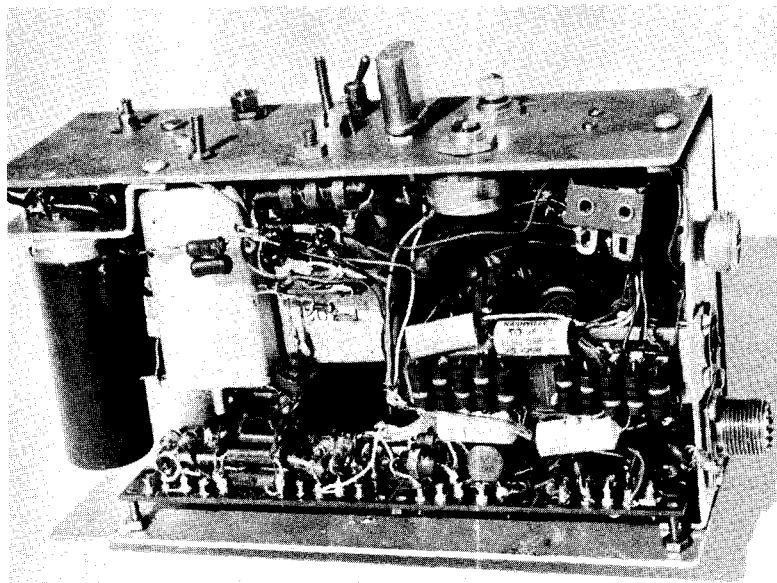

Figure 11
UNDER-CHASSIS
VIEW OF
TRANSISTORIZED
SSB EXCITER

The audio and r-f networks are mounted on a phenolic sheet attached to the bottom of the chassis. The 12BY7A linear amplifier and shield are mounted on a small aluminum bracket at the left of the assembly. Grid coil L_2 is beside the tube, and plate coil L_1 is behind the tube. Coil L_3 is to the right of L_2 with sideband switch S_2 behind it. The two r-f balancing controls R_1 and R_2 are at the extreme right of the chassis panel.

to reduce the 12.6 volt primary supply to 9 volts for the 2N170 stage, and to 4 volts and $2\frac{1}{2}$ volts for the preamplifier stage. The exciter is designed for use with a primary supply having the positive terminal of the battery grounded.

Exciter Construction The exciter is built within an aluminum case measuring $7\frac{1}{4}$ " x 4" x $2\frac{1}{2}$ " in size. Miniaturization of the audio phase shift network was accomplished by measuring a quantity of resistors and capacitors on a bridge. Final selection was made from those having the closest tolerances. These hand picked components are mounted on a phenolic terminal strip. This same sheet is used to support the small r-f chokes as well as the balanced modulator components.

It is a good idea when building equipment to fit in a limited space to construct everything in the form of sub-assemblies. This will permit the components to be mounted in the open, facilitating wiring. In this particular unit, the audio components and the r-f modulator are mounted on a phenolic board on one side of the box and the r-f components are attached to the opposite wall of the box. The oscillator coil L_1 is placed within an old i-f transformer can as is the linear amplifier grid coil L_2 . The 12BY7A tube is mounted on a small bracket at one end of the box, and has a tube shield placed over it. The plate coil L_3 of the amplifier stage is directly behind the tube (figure 11). Various voltage dropping resistors are mounted on a small terminal board at the center of the chassis, and the audio transistors are placed in the area between the lower terminal board and the rear wall of the case.

The r-f circuits are wired after the component boards are mounted in place. Wiring is straightforward and simple. The two r-f transistors are mounted by their leads to three terminal phenolic tie-point strips. Be sure to protect both the transistors and the modulator diodes from excess soldering heat, as described in section 28-1. The reader is referred to this section concerning the adjustment and test procedure for the home-made phase shift network.

Testing The Exciter The transistorized SSB exciter may be bench tested by running the transistors from a group of $1\frac{1}{2}$ volt batteries. It is wise to conduct preliminary tests at an operating potential of about 9 volts. The voltage may be boosted to the operating value after tuning and alignment adjustments have been completed. Volt-

age should be first applied to the transistor oscillator. R-f output may be measured at the terminals of the bifilar coil with the aid of a vacuum tube voltmeter. The slug of coil L_1 is adjusted for maximum reading. Under diode load, about 4 volts r.m.s. may be measured from either side of the winding to ground. The bifilar winding is relatively critical. Too many turns will load the oscillator to a point of instability, and too few turns deliver insufficient drive to the modulator. Two turns, loosely coupled to the primary winding, seem to be about correct. When the bridge is unbalanced, approximately 0.2 volt r.m.s. may be measured from either arm of output potentiometer R_2 to ground. This voltage is stepped up by means of a pi-network circuit so that maximum excitation voltage is applied to the base of the 2N114 r-f transistor.

Preliminary adjustments, in general, follow those described for the vacuum tube exciter described in section 28-1. Potentiometers R_1 , R_2 , and R_3 are adjusted for minimum carrier output in the collector circuit of the 2N114. It may be necessary to add a $10 \mu\mu\text{fd}$ variable ceramic capacitor from one side of the modulator bridge to ground to achieve maximum carrier suppression. The final adjustment is to apply an audio signal and touch up the audio phasing potentiometer R_3 for maximum rejection of the unwanted sideband.

When these preliminary adjustments have been made, the 12BY7A tube may be inserted in the socket, and the shield slipped over the tube. Grid inductor L_2 is resonated for maximum grid excitation with the aid of grid dip oscillator, and the plate inductor L_3 can be tuned in the same manner. A dummy load consisting of two 6.3 volt, 150 ma. flashlamp bulbs (brown bead) connected in parallel is attached to output jack J_1 . Plate voltage and excitation are now applied to the linear amplifier stage and L_2 and L_3 adjusted for maximum output. When audio excitation is removed from the exciter the r-f amplifier will probably break into oscillation and the antenna bulbs will continue to glow. Neutralizing capacitor C_1 should now be adjusted with a fibre screwdriver until oscillation stops. After the exciter is operating properly, full battery voltage may be applied to the transistor stages with a consequent increase in grid drive and power output of the linear amplifier. Approximately 2 volts r.m.s. grid drive may be measured with the vacuum tube voltmeter at the grid pin of the 12BY7A linear amplifier stage under conditions of maximum excitation.

28-3 A VHF Transceiver of Advanced Design

Modern tubes and circuit techniques permit sensitivity and stability levels to be achieved in the VHF region that were possible only at the lower frequencies a few years ago. The transceiver described in this section makes full use of these advanced circuits to produce superb results in the amateur 50 Mc. and 144 Mc. bands.

The transceiver (pictured in figure 12) comprises a complete VHF station and power supply in one small, streamlined cabinet. The transmitter section is crystal controlled on any one of eleven frequencies chosen at random in the two bands, and runs eighteen watts input fully modulated. The receiver section employs cascode-type r-f amplifiers resulting in a noise figure better than 5 decibels on both bands. Optimum communications selectivity is obtained by the use of a two-section crystal lattice filter in the intermediate frequency amplifier. Maximum frequency stability is achieved by the use of crystal controlled VHF conversion oscillators and a highly stable low frequency tunable oscillator. A signal strength meter is incorporated in the receiver, and a tuning meter is used to obtain optimum transmitter adjustment. The power supply operates from 115 volts a.c., and either 6- or 12-volts d.c.

Styling for the transceiver permits its use either as a fixed, home station or as a mobile unit. The major tuning controls are placed at the left of the panel to permit operation while the automobile is being driven. A push-to-talk system is employed for rapid break-in operation, and band changing takes place in a few

seconds. Twenty tubes including a voltage regulator are employed in the unit, and the total primary power consumption is approximately 105 watts.

Circuit Description This high performance transceiver is a complex device, and the wiring diagram has been broken down into several schematic drawings (figures 14, 15, 17, 18, and 19). A block diagram of the complete circuit is given in figure 13.

The Receiver Section. The receiver portion of the unit employs thirteen tubes in a double conversion superheterodyne circuit. Separate r-f "front ends" are employed for each band. Each "front end" employs a 6BZ7 cascode r-f amplifier and a 6J6 converter/oscillator tube. The desired section is activated by energizing the filaments and connecting the output circuit of the mixer stage to the first i-f amplifier. Switch S_1 accomplishes this action. The 144 Mc. cascode amplifier is neutralized for optimum signal-to-noise ratio, while the neutralizing circuit is omitted from the 50 Mc. amplifier since a satisfactory noise figure is obtained without the extra coil. Overtone crystals operating in the VHF region are used in a regenerative oscillator circuit to provide mixing voltage for the 6J6 triode converter. The complete schematic of the r-f section is given in figure 14.

The tunable intermediate frequency amplifier covers the range of 30 - 34 Mc. "Low side" oscillator operation is used for two meter operation with the conversion crystal at 114 Mc. "High side" operation is used for six meter service with the crystal at 84 Mc. The four megacycle i-f tuning range is covered by a

Figure 12
VHF Transceiver for Six and Two Meters is Designed for Fixed or Mobile Operation

This transmitter-receiver provides the highest order of reliable communication in the two most popular VHF bands. Receiver tuning controls are placed at the left of the unit to permit ease of tuning in mobile installation. Double conversion receiver and crystal lattice i-f filter provide maximum stability and selectivity for reception. Crystal controlled transmitter delivers a ten watt carrier. Band change takes only a few seconds. Left hand meter is signal strength indicator for receiver, and meter at right is multi-purpose milliammeter for transmitter. The transmitter tuning controls are at right. Perforated metal cabinet insures maximum ventilation for continuous operation.

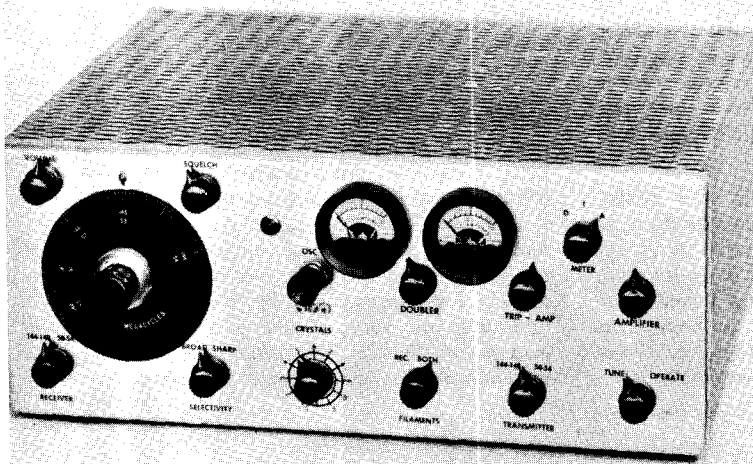

TV-type rotary induction tuner, padded to the correct operating range. The use of this type of tuned circuit provides exceptional stability combined with small size and has proven to be a very satisfactory choice. A 6BJ6 remote cutoff pentode is used as the first i-f amplifier stage (V₅) and a 6BE6 is used as the second mixer (V₆). The tunable oscillator stage operates 2009 kilocycles lower than the variable intermediate frequency and employs a single section of a 6J6 tube (V₇). A small inductance (L₁₁) is placed in series with the rotary coil of the oscillator section to ensure proper tracking over the 4 Mc. tuning range.

The greater portion of the receiver gain and selectivity is achieved in the second intermediate frequency amplifier which operates at a center frequency of 2009 kc. A double lattice crystal filter is employed to ensure maximum selectivity at this frequency. The filter is made in two sections and has a single 6BJ6 amplifier tube (V₉) between the sections to compensate for the insertion loss of the filter.

The first section of the filter is placed immediately after the 6BE6 converter tube to achieve maximum i-f amplifier protection from strong signals adjacent to the desired one. Two

crystals are used, one at a frequency of 2007 kc. and the other at a frequency of 2011 kc., providing a "flat top" to the passband of about 4 kilocycles. The crystals used in this filter are specially cut for filter work, and the substitution of ordinary "transmitter type" crystals will degrade the performance of the filter. The units specified in figure 15, however, are not expensive. The i-f transformers are standard 1500 kc. units with the mica tuning capacitors changed as shown in figure 15 to permit operation at 2 Mc. The lattice filter may be removed from the circuit by means of the "sharp-broad" switch, S₁. All four crystals are shorted out in the "broad" position, and one crystal in each filter section is disconnected from the associated i-f transformer. In addition, another section of the switch (S₁C) drops the gain of the amplifier tube (V₉) to compensate for the rise in stage gain that occurs when the crystals are removed from the circuit. Two additional stages of i-f amplification (V₈, V₁₀) follow the crystal filter, providing an abundance of gain for proper operation of the a-v-c and audio squelch circuits.

The detector and associated audio components of the receiver are shown in figure 17. A

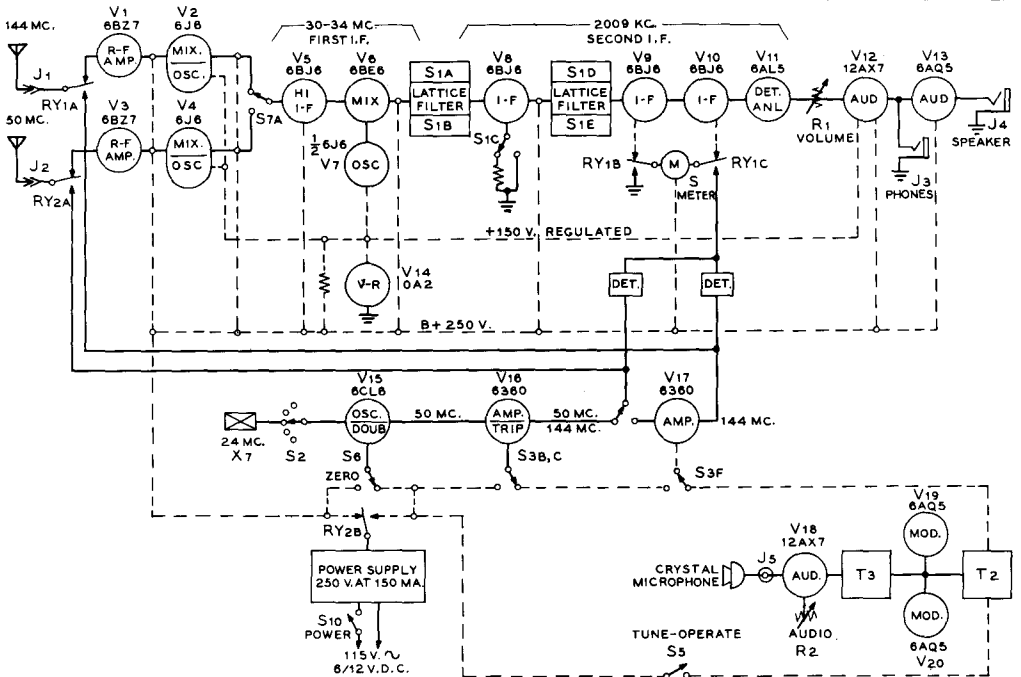

Figure 13

BLOCK DIAGRAM OF 2-6 METER TRANSCEIVER

Twenty tubes plus selenium rectifier power supply provide de-luxe operation for the advanced VHF enthusiast. Power supply may be operated from either automobile electrical system or 115 volts, a.c.

6AL5 (V_{11}) is employed as detector, a-v-c, and a-n-l tube. The noise limiter is of the low distortion type and is left in the circuit at all times. One section of the 6AL5 serves as the a-v-c rectifier, and the resulting voltage is applied to four i-f tubes for smooth a-v-c action on strong signals. The last i-f stage (V_{10}) is left off the a-v-c line, and the S-meter is connected between the plate supply return of this tube and an adjacent controlled tube. A change in the plate current of the controlled tube (V_9) upsets the balance of the bridge circuit, and a meter reading is produced that is proportional to the a-v-c voltage. This voltage is also applied to one section of a double triode audio tube (V_{12}) which functions as a squelch tube. This circuit renders the audio section of the receiver inoperative until the receiver a-v-c circuit is activated, thus eliminating a large portion of the background noise commonly associated with VHF reception. The squelch circuit may be disabled by switch S_5 . Two audio

stages (V_{12} and V_{13}) deliver sufficient audio power to fully drive a loudspeaker and to overcome the motor and wind noises of a car in motion. An auxiliary jack (J_3) provides ear-phone reception if desired. The receiver is inactivated during transmission periods by relay contacts RY2B which remove the high voltage from the plates and screens of the receiver tubes.

The Transmitter Section. Shown in figure 17 is the transmitter section of the transceiver. Six tubes are used, three for the audio portion of the unit and three for the r-f portion. Crystals in the 24-25 Mc. region are employed for both 6- and 2-meter operation. Any one of eleven crystals may be selected by switch S_2 . The oscillator is a 6CL6 (V_{15}) in a "hot-cathode" doubler circuit, delivering energy in the 48-50 Mc. region. A split-stator tuning capacitor is employed in the plate circuit to provide a balanced output configuration. The oscillator stage may be turned on during re-

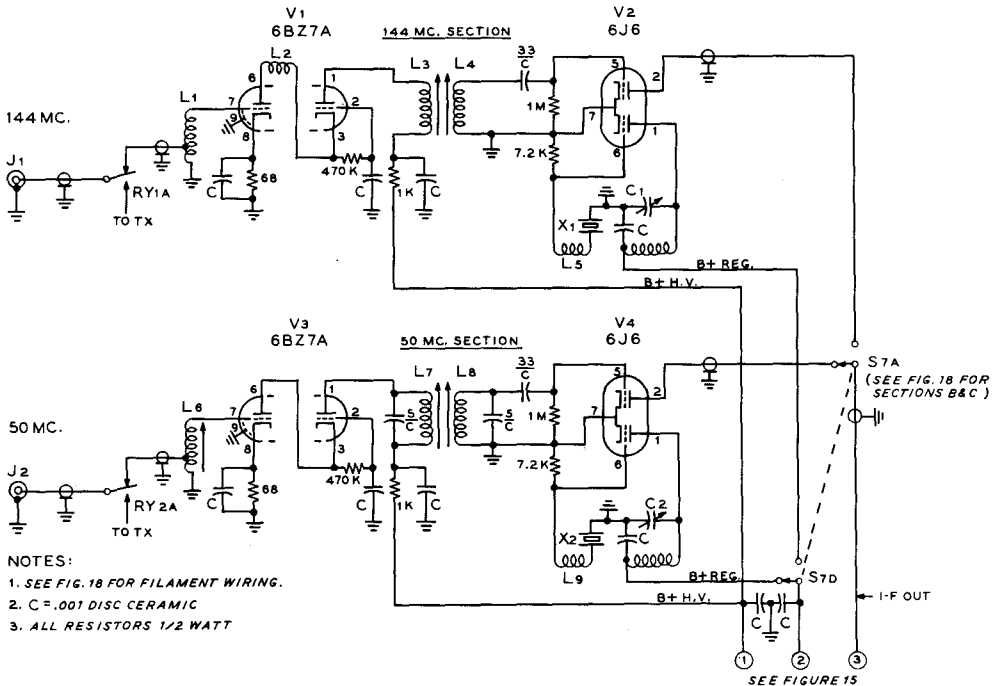
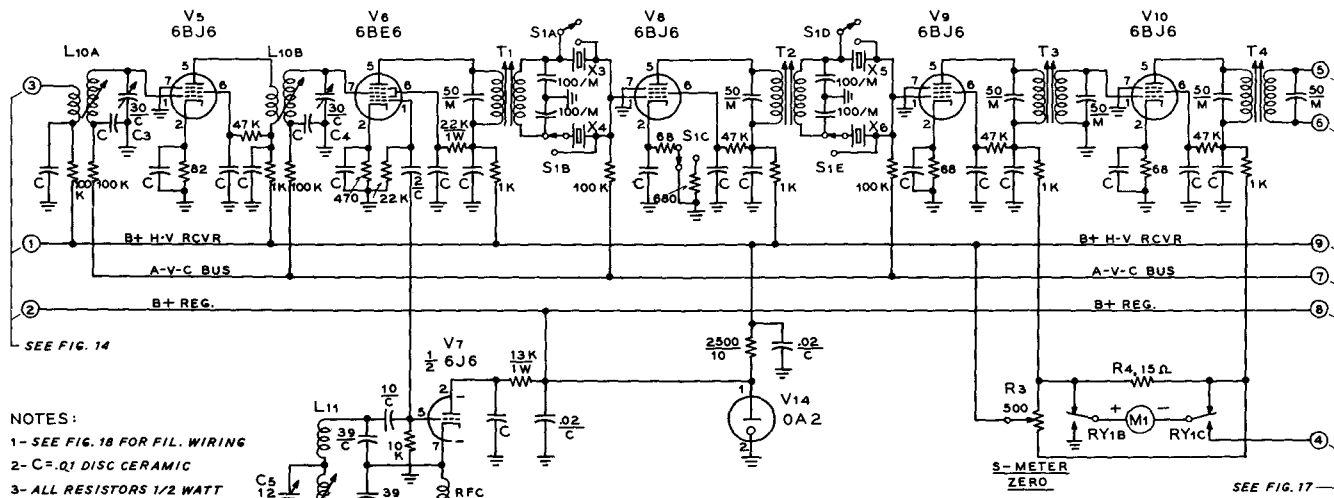

Figure 14
 SCHEMATIC, R-F PORTION OF RECEIVER SECTION

- C—.001 μ fd. disc ceramic capacitor. Centralab DD-102
- C₁, C₂—20 μ fd. Johnson 20M11
- J₁, J₂—BNC-type coaxial receptacle
- L₁, L₂—See figure 21 for coil information
- S_{7A}, D—Part of S7 (Centralab wafer PA-9) See figure 18.
- RY_{1A}, RY_{2A}—See figure 19
- X₁—114 Mc. overtone crystal. Precision Crystal Lab., Santa Monica, Calif.
- X₂—84 Mc. crystal (see X₁)



- NOTES:
- 1- SEE FIG. 18 FOR FIL. WIRING
 - 2- C = .01 DISC CERAMIC
 - 3- ALL RESISTORS 1/2 WATT UNLESS OTHERWISE NOTED
 - 4- S1 IN "XTAL IN" POSITION
 - 5- RY1 IN "RECEIVE" POSITION

Figure 15
SCHEMATIC, I-F PORTION OF RECEIVER SECTION

- C₃, C₄—30 μ fd. ceramic trimmer. Centralab 827-C
- C₅—12 μ fd. ceramic trimmer. Centralab NPO
- L₁₀-L₁₁—See figure 21 for coil information
- M₁—0-1 d.c. milliammeter. De-jur #112
- RY₁B, RY₁C—See figure 19
- S₁A-S₁E—2 wafers, 6 pole, 2 position each wafer. (Two Centralab PA-9 wafers with PA-301 index assembly)
- T₁-T₃—Modified 1500 kc. slug-tuned interstage i-f transformer. (J.W. Miller 12-W1). Remove internal resonating capacitors. Replace plate capacitor with 50 μ fd. mica, and grid capacitor with two 100 μ fd. mica capacitors connected in series. Ground common tap of capacitors. Transformer now tunes to 2009 kc.
- T₄—1500 kc. slug-tuned i-f output transformer. (J. W. Miller 12-W2). Modify as above.
- X₃-X₅—Lattice crystal set. 2007 kc. and 2011 kc. Precision Crystal Labs., Santa Monica, Calif.
- X₆-X₈—Same as X₃-X₅.
- RFC—39 μ h. J. W. Miller 4628

ception by depressing the "zero" switch S_6 , which applies plate voltage to the oscillator by way of the receiver circuits.

The balanced output circuit of the oscillator stage is inductively coupled to a push-pull miniature beam amplifier stage employing a 6360 (V_{16}). The grid circuit of this stage is broadly resonant to the 50 Mc. region by virtue of the interelectrode capacitances of the tube. For six meter operation, the 6360 functions as a class-C amplifier with the plate circuit ($L_{13}-C_7$) tuned to 50 Mc. Bias and screen voltages are set for optimum operating values by segments of switch S_3 . In addition, the plate return of the stage is routed through the secondary of modulation transformer T_2 . The r-f output circuit is inductively coupled to the 50 Mc. antenna coaxial receptacle through relay contacts RY2A.

When switch S_3 is moved to the 144 Mc. position, the aforementioned 6360 stage is converted into a high efficiency tripler stage, providing output in the 140-150 Mc. region. Switch segment S_3D raises the operating bias on the stage, segment S_3E drops the screen voltage, and segments S_3A-B select the proper plate tank coil, L_{14} .

A separate amplifier stage employing another 6360 dual beam power tube (V_{17}) is used for 2-meter operation. The tube functions as a class-C amplifier and is driven by the push-pull tripler stage (V_{16}). The grid circuit of the 144 Mc. amplifier is inductively coupled

to the tripler, and the plate circuit (C_0-L_{15}) is inductively coupled to the output circuit. A separate antenna receptacle (J_1) is used for 144 Mc. operation. Plate voltage is applied to this tube by switch section S_4F .

The use of inductive coupling between the three stages of the transmitter reduces spurious emissions to a minimum. Channel 2 television interference, so common to six meter transmitters is absent when this transmitter is used, thanks to the combination of interstage inductive coupling and the employment of 25 Mc. crystals. Power input to the modulated stage on both bands is close to 18 watts, permitting a carrier power of over 10 watts.

Transmitter adjustment is greatly simplified by the use of r-f volt-meters connected to the output circuits of each amplifier stage. Small germanium diodes (D_1 and D_2) are used to rectify a minute portion of the output voltage which is read on the multi-meter M_1 of the transmitter. All tuning adjustments of the transmitter are conducted so as to enhance the reading of the r-f voltmeter under a given set of antenna conditions.

The transmitter is plate modulated by two 6AQ5 tubes (V_{19} , V_{20}) operating class AB₁. Plate voltage may be removed from these tubes and from the modulated amplifier by the "tune-operate" switch S_5 . A single 12AX7 serves as a two stage resistance coupled audio amplifier, having sufficient gain for the use of a crystal or dynamic microphone.

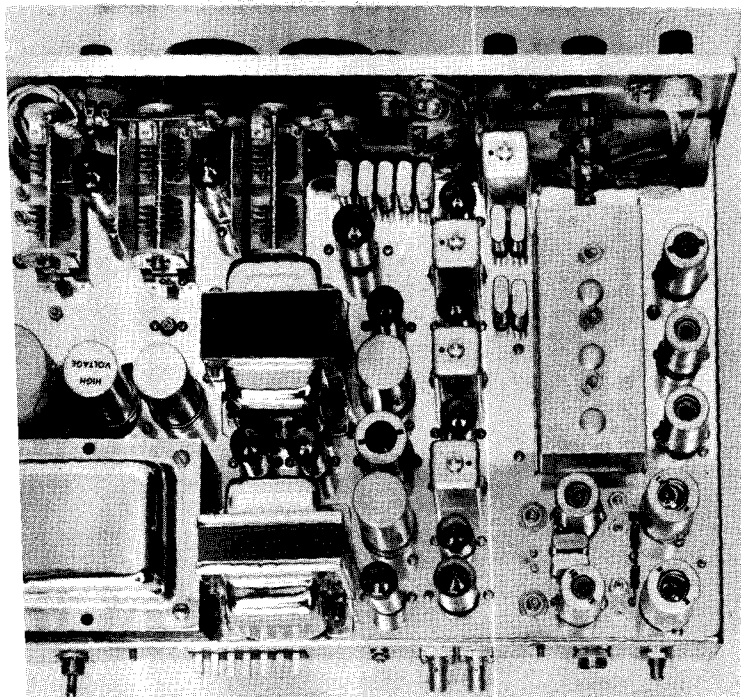
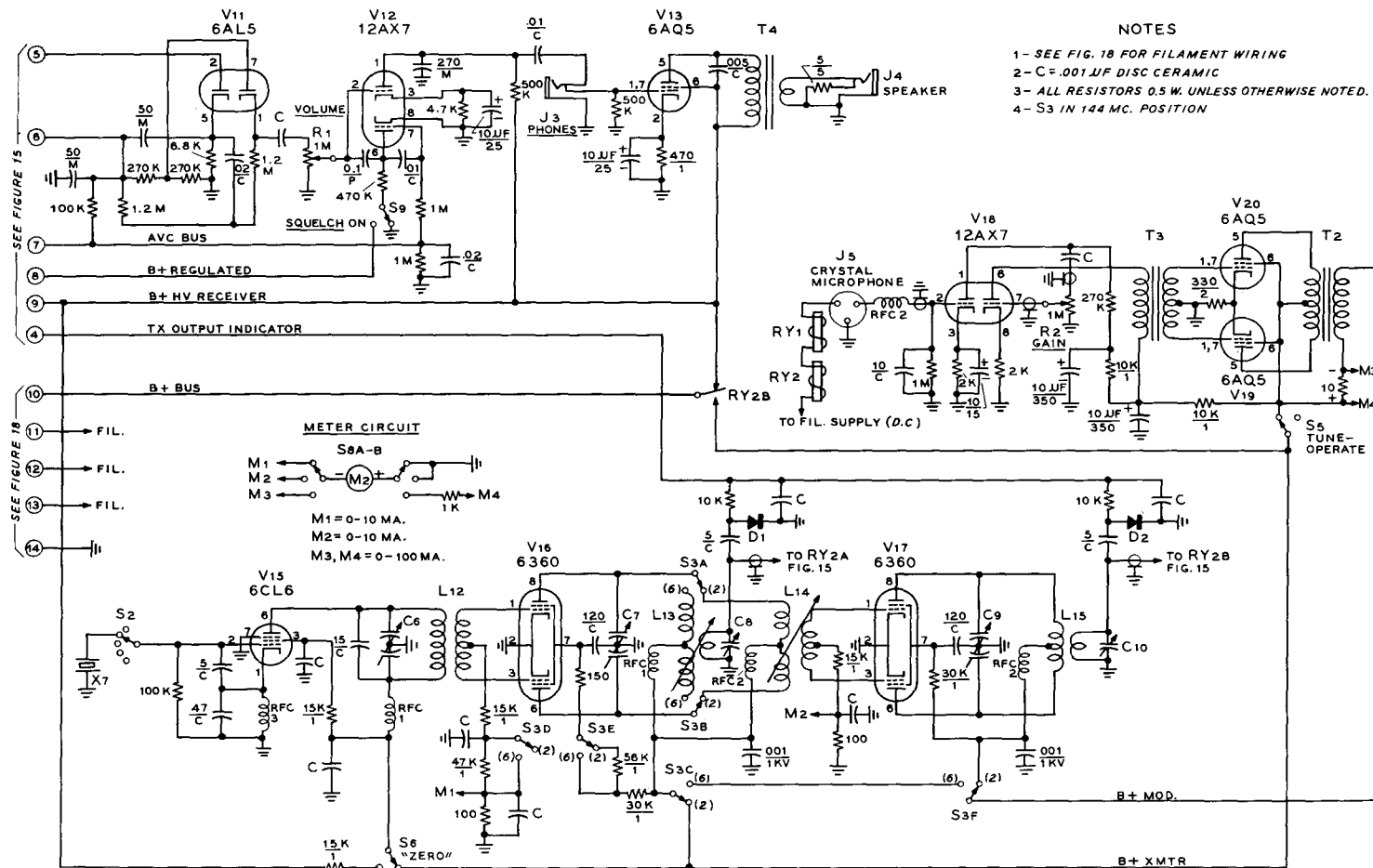

Figure 16

REAR VIEW OF VHF TRANSCEIVER

At the left rear of the chassis is the dual purpose power supply with the vibrator and filter capacitors mounted in front of the power transformer. At the front of the chassis are the two 6360 tubes and the tuning capacitors of the transmitter. Note that the stages are isolated by shields placed between the tuning capacitors and tubes.

The modulator and power supply filter choke occupy the center portion of the chassis, with the receiver i-f section to the right. In front of the i-f strip are the transmitter crystals and the lattice crystals. At the right of the chassis are located the "TV-type" variable inductor tuner and the three tunable i-f stage tubes. At the rear of the chassis, directly behind the tuner are the two VHF conversion oscillators. The microphone receptacle and audio gain control are on the rear lip of the chassis, directly below the cascade stages. Cabinet and chassis custom made by California Chassis Co., Lynwood, Calif.



- NOTES
- 1- SEE FIG. 18 FOR FILAMENT WIRING
 - 2- C = .001 JUF DISC CERAMIC
 - 3- ALL RESISTORS 0.5 W. UNLESS OTHERWISE NOTED.
 - 4- S3 IN 144 MC. POSITION

Figure 17

SCHMATIC, TRANSMITTER AND AUDIO SECTION OF TRANSCEIVER

- C₁, C₂, C₃—15/15 μfd. Hammarlund HFD-15X
- C₄, C₁₀—30 μfd. Johnson 25112
- D₁, D₂—Germanium diode 1N81
- L₁, L₁₅—See figure 21 for coil information
- RFC₁—7.0 μh. Ohmite Z-50
- RFC₂—1.8 μh. Ohmite Z-144
- RFC₃—0.15 μh. J. W. Miller 4644

- S₂, S₃, S₄—Same as S₁, figure 15. Space decks so coils L₁ and L₁₄ fit between the decks.
- S₅—SPDT "push-button" switch
- S₆—2 pole, 3 position non-shorting switch. Mallory 3223-G
- RY₁, RY₂—See figure 19
- M₂—0-1 d.c. milliammeter. De-jur #112
- T₂—25 watt modulation transformer, 10K pri., 5 K sec. Stancor A-3845
- T₃—Interstage transformer, 1:3. Stancor A-53C
- X₁—24-26 Mc. overtone crystal. Precision Crystal Co., Santa Monica, Calif.

The power transformer is made from a TV-replacement type, with a new vibrator winding replacing the usual 6.3 volt filament windings. Information covering the conversion of the transformer will be found later in this section. The special winding may be arranged for either 6-volt d.c. or 12-volt d.c. operation, but not both. Thus, the choice of d.c. supply voltage must be determined before the transformer is modified.

The filaments of the transceiver are arranged in a series parallel circuit so that they may be operated from either 6- or 12-volts d.c., or 6.3 volts a.c. with no change in circuitry. The appropriate filament connections to the power supply are automatically made when the proper terminal plug is inserted in SO₁. A simplified drawing of the primary power wiring of the transceiver is shown in figure 18.

Relay and Switching Circuits. The control circuits of the de-luxe transceiver are shown in figure 19. Two relays control change-over operation. The relay coils are of the d.c. type, and are connected in series with the push-to-talk button of the microphone and the filament voltage supply. Closing the microphone switch grounds one end of the relay coil circuit and actuates both relays. Relay RY₁ controls the 144 Mc. antenna changeover, and switches the S-meter to the r-f output meter circuit of the transmitter section. Relay RY₂ controls the 50 Mc. antenna changeover, and switches the B-plus from the receiver to the transmitter.

Meter M₂ serves as a multi-meter for the transmitter portion (figure 17). The basic meter has a 0-10 d.c. millimeter movement and is used as-is for measuring the grid current of V₁₆ and V₁₇. Meter switching is accomplished by means of S₅. The third position of the switch connects the meter across the shunt in the plate circuit of the modulated amplifier stage. The resistance of the shunt is chosen so that full scale meter deflection is 100 milliamperes.

Transceiver Layout and Assembly The transceiver is housed in a special cabinet measuring 14" long, 10" deep, and 5½" high. The cabinet is formed from "cane metal" stock and has a removable front panel. The back, which is also made of solid material is welded to the wrap-around cane-metal cover. The chassis of the unit is made of sheet steel which is copper plated after all major holes have been drilled. Chassis height is 2 inches. Placement of the major components may be seen in figure 16. The receiver section occupies the right-hand por-

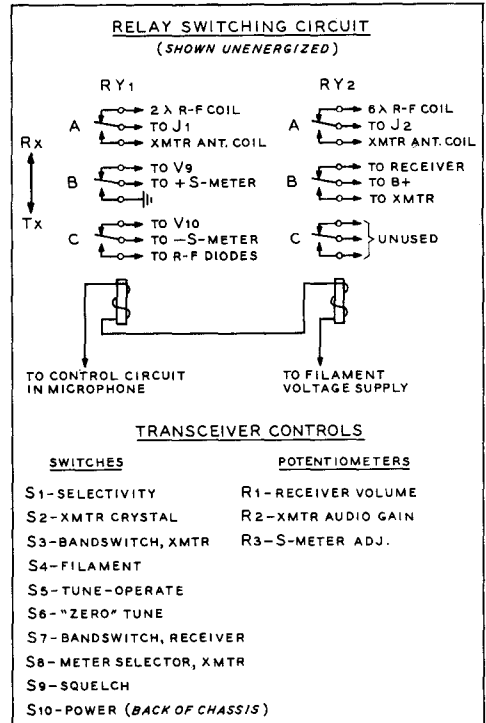

Figure 19
RELAY CONTROL WIRING AND LIST OF TRANSCEIVER CONTROLS
RY₁, RY₂—3 pole, DT. Advance MF3C/6VD.
Hook coils in parallel for 6 volt operation.

tion of the chassis, with the power supply to the rear left, and the transmitter at the upper left of the photograph. The variable TV-type tuner is panel driven by the main tuning dial through a simple speed reduction gear (Crowe). To the side of the tuner are tubes V₅, V₆, and V₇. To the rear of the tuner are the two separate "front end" sections of the receiver. The two cascade stages are in the corner, with the 6J6 mixer/oscillator tubes to the left. The various coil slugs and tuning capacitors are mounted to the chassis deck and are adjustable from the top of the unit. Near the center of the chassis and running from the front to the back is the 2009 kc. i-f strip. The four crystals of the i-f filter are seen near the front of the chassis directly behind i-f transformer T₁. To the left of the i-f strip arranged in a line are the voltage regulator tube V₁₄, the first 10μfd. filter capacitor for the speech amplifier, the speech amplifier tube V₁₅, the second 10μfd. filter capacitor, and the receiver audio amplifier/squelch tube V₁₂. To the left of these components are the two 6AQ5 modulator tubes and transformers T₂ and T₃. In the far left

corner of the chassis are placed the power transformer T_1 , the vibrator VIB_1 , and the two power supply filter capacitors. Note that the case of one of the capacitors is "hot" to ground and the unit is mounted on a fibre base ring.

The transmitter components occupy the upper left chassis area of the transceiver. The 6CL6 oscillator stage is at the center of the chassis with tuning capacitor C_6 to the left. A small aluminum shield isolates the oscillator components from the 6360 buffer/amplifier tube. A second shield plate is placed between the second stage tuning capacitor C_7 and the 6360 144 Mc. amplifier.

Space is provided on the chassis to mount five miniature crystal holders for the transmitter oscillator circuit. A small aluminum clamp holds five additional crystal sockets to the rear of crystal selector switch S_2 , as seen in the under-chassis photograph of figure 20.

The power supply area beneath the chassis is separated from the remainder of the circuitry by a 2 inch high copper shield that encloses the selenium rectifiers and other small supply components. Leads passing out of this compartment go through chassis mounting type miniature feedthrough capacitors mounted in holes in the shield (*Centralab FT-1000*).

The "broad-sharp" switch S_1 may be seen in the upper left area of the chassis. Each segment of the switch is placed over a group of i-f crystal sockets so that the leads from the crystals to the switch contacts are extremely short. To the left of this switch is the S-meter "zero" potentiometer R_3 . The receiver bandswitch S_3 is located adjacent to the cascode amplifier

stages at the rear of the chassis and is actuated from the panel by an extension shaft.

The r-f section of the transmitter is visible in the upper right area of the chassis, running parallel to the front panel. A small brass shield is passed across the center of each of the 6360 tube sockets. The shield passes between pins 1 and 9, and 3 and 4. Transmitter band-change switch S_3 is located in the center compartment and the adjoining shields prevent coupling between the coils of this circuit and either the 144 Mc. amplifier coil or the 50 Mc. oscillator coil.

Transceiver Wiring The transceiver is a complex piece of equipment and should be wired with care. Space is at

a premium and wiring errors are difficult to find when working in a small area. It is therefore suggested that the unit be wired in sections. The receiver should be wired first, and placed in operation with an auxiliary power supply. The transmitter may be wired next and tested for operation with the receiver. Finally, the power transformer should be converted and the power supply can be wired and tested within the transceiver. The final check is to make sure that all sections operate properly as a complete system.

Wiring the Receiver Section. The receiver section should be wired first. It is imperative that all r-f wiring and ground leads be short and direct. As many components as possible are mounted between the pins of the tube sockets and the socket ground lugs. Miniature disc ceramic capacitors are used for bypass pur-

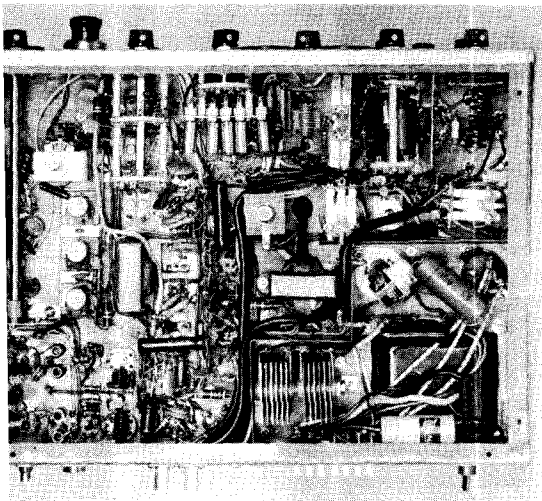

Figure 20
UNDER-CHASSIS VIEW OF
TRANSCIVER

General layout of the components below the chassis may be seen in this view. At the lower right are the power supply components, separated from the rest of the circuitry by a copper shield. RY_1 , RY_2 , and the audio driver transformer are just above this shield. Across the front of the chassis is the transmitter section with the inter-stage shields mounted across the tube sockets. At the center is the crystal switch with five crystals mounted to the wafer of the switch. Directly behind this switch is the i-f section of the receiver and the audio output transformer. In the lower left corner are the cascode r-f stages and the bandswitch for the receiver which is mounted on a small bracket and panel driven by an extension shaft. In front of this switch are the components of the tuned first conversion stage. The trimmers used with the TV "inductuner" are mounted on the tuner terminals.

Sections of $1/4$ -inch coaxial cables connect the various antenna circuits to the change-over relays and the coaxial antenna receptacles on the rear of the chassis.

FIGURE 21
COIL TABLE FOR 2 AND 6 METER TRANSCEIVER

RECEIVER SECTION, FIGURES 14 AND 15

L1-6T. #20 E., 3/8" DIA., 1/2" LONG. TAP 2 1/2 T. FROM GROUND END.

L2-12 T. #20 E, 3/16" DIA. 7/16" LONG. MOUNT BETWEEN PIN 3 AND PIN 6 OF SOCKET V1.

L3, L4-5T. #18 E. 1/4" DIA., SPACED WIRE DIA. ON CTC IRON CORE FORM PLS6. CENTER-TO-CENTER DISTANCE BETWEEN L3 AND L4 IS 3/4".

L5- PLATE WINDING: 6T. #16 E, 5/16" DIA. 1/2" LONG. GRID WINDING: 1 T. PLASTIC HOOKUP WIRE BETWEEN TWO "COLD" END TURNS OF PLATE WINDING.

L6-10T. #20 E, 3/8" DIA., 1/2" LONG. TAP 4T. FROM GND. END

L7, L8-16T. #20 E, CLOSEWOUND ON CTC IRON CORE FORM PLS6. CENTER-TO-CENTER DISTANCE BETWEEN L7 AND L8 IS 3/4".

L9- PLATE WINDING: 9T. #16 E, 5/16" DIA. 5/8" LONG. GRID WINDING: 1 T. PLASTIC HOOKUP WIRE BETWEEN TWO "COLD" END TURNS OF PLATE WINDING.

L10A, B, C - MALLORY INDUCTUNER, VHF TV TYPE, MODEL 8303

L11- 0.33 UH. J.W. MILLER 4586 R-F CHOKE.

TRANSMITTER SECTION, FIGURE 17

L12- PLATE WINDING: 12T. #16, 3/4" DIA. 3/4" L. 88W 3011. GRID WINDING: 7 T. #16, 1" DIA. 9/16" L. 88W 3015. PLACE PLATE COIL WITHIN GRID COIL. CIRCUIT RESONATES TO 24-26 MC. REGION.

L13- PLATE WINDING: 18T. #16 E. 1/2" DIA., 1 1/2" L. WITH 1/4" SPACE AT CENTER OF WINDING. CIRCUIT RESONATES TO 50-54 MC. REGION. ANTENNA WINDING: 3 T. #20 E. 1/2" DIA. 1/4" LONG AT CENTER OF PLATE WINDING.

L14- PLATE WINDING: 6T. #16 E. 1/2" DIA., 1 1/2" L. WITH 1/4" SPACE AT CENTER OF WINDING. CIRCUIT RESONATES TO 144-148 MC. REGION. GRID WINDING: 4 T. #20 E. 1/2" DIA. 1/4" LONG AT CENTER OF PLATE WINDING.

L15- PLATE WINDING: SAME AS L14, #14 E. WIRE. ANTENNA WINDING: 3 T. #20 E., 1/2" DIA. 1/4" LONG AT CENTER OF PLATE WINDING.

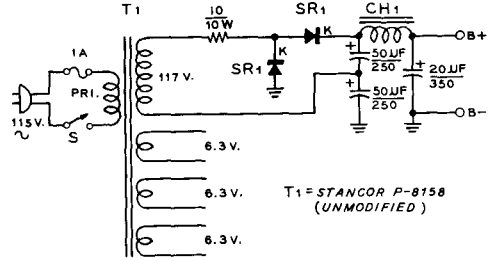

Figure 22
TEST POWER SUPPLY FOR TRANSCEIVER

Testing the Receiver Section. After the receiver wiring is completed, it should be thoroughly checked for errors and omissions. Have another person check your wiring, as it is often difficult to find your own errors. When you are sure of the circuitry the receiver section may be connected to the test power supply shown in figure 22. This supply makes use of the transceiver components and may be wired "bread-board style" for the duration of the tests. A speaker is connected to the output jack of the receiver, and a modulated test signal of the intermediate frequency is injected on pin 5 of the 6BE6 mixer tube (V_6). A very small capacitor is used to couple the i-f signal into the receiver. Remove the 6J6 oscillator tube (V_7) for this test. The signal generator can be of the BC-221 type capable of being accurately set to a frequency half-way between the crystal frequencies of the lattice filter. (In this case, the mid-frequency is 2009 kc.) Switch S_1 is set to the "sharp" position and the tuning slugs of the i-f transformers are adjusted for maximum audio output. As the i-f strip is brought into alignment, the coupling to the signal generator should be reduced to prevent overloading.

The 6J6 mixer tube is now replaced and the signal generator is tuned to the first intermediate frequency of 34 Mc. The tuner is adjusted to the high frequency dial setting and oscillator trimming capacitor C_8 adjusted until generator is heard. R-f padding capacitors C_3 and C_4 are adjusted for maximum signal strength. If a short antenna is attached to the rotor arm of transfer switch S-A, signals in the 30 - 34 Mc. range should be easily received.

Switch S_2 is next set to 50 Mc. and the r-f amplifier (V_4) and mixer tube (V_2) for this range are placed in their sockets. Oscillator tuning capacitor C_9 and the coupling between coil L_9 and the crystal feedback winding are adjusted for stable operation of the oscillator stage. The oscillator may be monitored in a

poses in the r-f section of the receiver and every attempt should be made to keep the leads as short as possible. Components associated with tubes V_5 , V_6 , and V_7 are mounted between the socket pins and an eight terminal phenolic tie-point strip attached to the side wall of the chassis immediately above the sockets. Trimming capacitors C_3 , C_4 , and C_5 are mounted directly to the terminals of the TV tuner. A twelve terminal phenolic strip mounts to the right of the i-f section of the receiver and supports various components of these stages.

After the majority of components have been wired, the r-f coils of the receiver are wound and soldered in position. They should be adjusted to resonance with the aid of a grid-dip oscillator. The first tunable i-f circuit ($L_{10}A-C_3$) and the 6BE6 grid circuit ($L_{10}B-C_4$) may be adjusted with the aid of the grid-dip oscillator to cover 30 - 34 Mc. as the main tuning dial of the receiver is tuned throughout its range. The mixer circuit ($L_{10}C-C_5$) covers the range of 28 - 32 Mc.

nearby receiver tuned to 84 Mc. A signal in the 50-54 Mc. range is now injected in the antenna receptacle (J_2) of the receiver section, and the adjustable slugs of coils L_7 and L_8 tuned for greatest signal response. The last step is to adjust the slug of antenna coil L_6 .

Switch S_7 should be set to the 144-148 Mc. range and tubes V_1 and V_2 are placed in their sockets. Oscillator operation is checked at 114 Mc., and coils L_1 , L_3 , and L_4 are adjusted for maximum signal response in the 2 meter band. When the receiver is operating properly on both bands, the transmitter section of the transceiver may be wired and tested.

Wiring the Transmitter Section. The r-f section of the transmitter is wired first. Coupling coil L_{12} between the oscillator and buffer is made of two sections of coil stock that are telescoping, and the plate coil is placed within the grid coil. Coils L_{13} and L_{14} are mounted between the wafer sections of Switch S_3 . The 50 Mc. antenna coil is placed between the two windings of L_{13} , and the 144 Mc. grid coil of the 2 meter amplifier is placed between the dual windings of coil L_{14} . The various resistors associated with the bandswitch are mounted between the terminals of the switch. The 2 meter plate coil L_{15} is fastened to the terminals of tuning capacitor C_9 , which project through $\frac{1}{2}$ -inch clearance holes cut in the chassis. The 2 meter antenna coil is supported on two miniature ceramic insulator posts mounted adjacent to L_{15} . When the r-f wiring is completed, the various coils may be adjusted to operating frequency range by varying the spacing between the turns.

The audio section of the transmitter should be wired next. This is a straightforward operation and comparatively simple. Small shielded leads are run from the second section of the 12AX7 speech amplifier to the audio gain control R_2 mounted on the rear apron of the chassis near the microphone jack. A shielded lead runs from the microphone jack to the first section of the 12AX7. The coils of relays RY_1 and RY_2 are connected in series with the control pin of J_5 , and are returned to the filament circuit of the transmitter.

Testing the Transmitter Section. The transmitter is now temporarily connected to the auxiliary power supply and the 6CL6 oscillator tube and an appropriate crystal are inserted in their respective sockets. A test lamp should be made from a 6.3 volt, 150 ma. (brown bead) pilot lamp attached to a small loop of wire. This test lamp is coupled loosely to os-

cillator coil L_{12} and will light brightly when the oscillator stage is functioning. Capacitor C_6 is adjusted for steady operation of the oscillator. Bandswitch S_3 is now set to 50 Mc. and switch S_5 is set to the "tune" position removing plate and screen voltage from the amplifier tube. The 6360 is inserted in the buffer socket and meter switch S_8 is set to read the grid current of this stage. A reading of about 3.5 milliamperes can be obtained by proper adjustment of capacitor C_6 . The plate circuit of the 50 Mc. stage should be set to approximate resonant frequency with a grid-dip oscillator and a dummy load or antenna is attached to the 50 Mc. antenna receptacle J_2 . Switch S_3 is now set to the operate position and the push-to-talk relay circuit actuated. Amplifier tuning capacitor C_7 is adjusted for maximum meter reading when the meter is switched to the r-f voltmeter position. Plate current of the 6306 tube under this condition is approximately 70 milliamperes. The actual value of plate current may be checked by setting meter switch S_8 to the "amplifier" position (0-100 milliamperes).

The next step is to check the modulator. Insert tubes V_{18} , V_{19} , and V_{20} in their respective sockets. Advance gain control R_2 while speaking into the microphone in a normal tone. When checked in a nearby receiver the modulation should be clear and crisp.

After the transmitter section is operating properly on 50 Mc., attention should be given to the 2 meter section. A 144 Mc. antenna is attached to receptacle J_1 , and the 6360 amplifier tube (V_{17}) is inserted in its socket. Switch S_3 is placed in the "tune" position, and the coupling between the grid coil of this stage and buffer plate coil L_{14} adjusted for 3.5 milliamperes of grid current to V_{17} . Switch S_3 automatically activates tube V_{17} when the switch is placed in the 144 Mc. position. Finally, switch S_5 is placed in the "operate" position and the tuning (C_9) and loading (C_{10}) controls are adjusted for maximum indication on the r-f voltmeter. Plate current to the 2 meter stage is held at 70 milliamperes as measured on the amplifier position of meter switch S_8 .

The bandchange operation will now merely consist of selecting the proper transmitting crystal, setting S_3 to the proper position, and adjusting the transmitter controls for maximum reading of the r-f voltmeter. The complete bandchanging operation takes about fifteen seconds.

The Power Supply

When the transceiver is in working order, attention should be turned to the power supply sec-

tion (figure 18). At the time of construction, no power transformer was available that would provide the desired voltages and at the same time be capable of operation from both a 115 volt a.c. and a d.c. vibrator primary source. It is necessary, therefore, to find a power transformer that has suitable high voltage windings and to remove the filament windings, replacing them with a special multi-purpose winding that will fill the bill. The *Stancor P-8158* was used in this transceiver, and does the job nicely. This transformer has a 115 volt primary winding, a 117 volt secondary winding designed for voltage doubler service, and three 6.3 volt filament windings. The three filament windings are on the outside of the transformer and may be easily removed.

Power Transformer Modification. The four transformer bolts should be removed, exposing the copper shorting band of the transformer, which is taken off. Take off the layers of cambric tape to expose the uppermost filament winding. Now, remove the unused filament windings, being careful not to damage the other windings of the transformer. A new winding made of enameled wire should now be placed over the remaining windings. This winding will be for either six or twelve volt operation, and will have a voltage tap for filament operation when the supply is run from alternating current. During battery operation the filaments of the transceiver will be run directly from the d.c. primary source.

Decide whether you want a six or twelve volt primary winding. The six volt winding will be made of #14 wire, whereas the twelve volt winding will be made of #16 wire. Each winding will have a tap at the proper point to provide voltage for the tube filaments. This new winding is shown on transformer T₁, figure 18.

The new winding will be put on in two halves, since two separate windings are required for proper operation of the "full-wave" vibrator. The six volt winding consists of *two separate windings of 14 turns* of #14 wire. The windings are wound on in series, with the two adjacent leads brought out as a center tap (see terminal B, T₁, figure 18). The 6.3 volt filament tap (terminal D, T₁) is placed ten turns from the junction of the two windings (point B). The windings should be carefully taped in place and the transformer reassembled. If twelve volt operation is desired, *two separate windings of 28 turns* of #16 wire are wound in series on the transformer. The filament tap for a-c operation of the filaments (D) is

placed at the 12.6 volt spot on the winding, or twenty turns from point B. Thus, the filaments work as a "six volt string" for 6/115 volt operation and as a "twelve volt string" for 12/115 volt operation. The two different arrangements of plug PL-2 necessary to accomplish this are shown in figure 18.

Testing the Power Supply. After transformer T₁ has been modified, the power supply should be wired in accord with figure 18. Before it is used with the transceiver, it should be tested with both a.c. and d.c. input circuits. The high voltage system should develop approximately 250 volts across a 1600 ohm 50 watt resistor, and a full 6.3 volts should be measured across a 1 ohm, 10 watt filament load resistor. The 12 volt configuration should develop the same high voltage under a similar load, and should deliver 12.6 volts across a 2 ohm, 10 watt resistor. If it is found that the voltages developed during operation from the d-c source are lower than the corresponding voltages derived from a-c operation, it is an indication that the modified primary winding has too many turns. The transformer should be removed from the installation and one turn removed from each half of the primary winding. This will boost the d.c. plate voltage about 10%. After the voltage has been set, the power supply wiring and switching circuits of the transceiver may be completed.

28-4 A Miniaturized SSB Transmitter for 14 Mc.

This 40 watt p.e.p. sideband transmitter was designed to provide the greatest amount of "talk power" for a given size and weight. It was built by W6AVA expressly for the purpose of permitting amateurs in far-off countries to have the opportunity to experiment with SSB transmission. The completely self-contained transmitter has been shipped around the world by air freight, and has been operated in such locations as Canton Island, Fiji, Brunei, Singapore, and other exotic spots.

The transmitter and power supply is contained within an aluminum case measuring 9" x 6" x 5" and weighs less than seven pounds. When encased in a strong cardboard box it is completely transportable by air express. Primary power source can be either 115- or 230-volts, 50 - 60 cycles. Air tested by many hours of operation under conditions of extreme heat and humidity, this small sideband transmitter has proven to be an effective design

that may provide inspiration for a more elaborate assembly. Tuning adjustments are simple and fool proof, and the transmitter remains in alignment without time consuming balancing of r-f and audio phase networks.

Transmitter Circuitry A block diagram of the circuit is shown in figure 24. Fourteen tubes are used including two voltage regulators. The filter method of sideband generation is employed using a 500 kc. *Collins* mechanical filter having a passband of 3.1 kc. The sideband signal is heterodyned to the 14 Mc. operating frequency by two mixer stages. A voltage doubler type silicon rectifier power supply provides high voltage for transmitter operation.

The complete transmitter schematic is given in figures 26 and 29. Sub-miniature tubes are used wherever possible to conserve space. The audio and sideband generation section of the transmitter is illustrated in figure 26. The heart of this section is the *Crosby* triple triode modulator stage (V_{2A} , V_{2A} , V_{2B}). The first triode serves as a cathode follower audio stage and is driven by a sub-miniature 5702 resistance coupled audio amplifier V_1 . The second triode is also a cathode follower (V_{2A}) and is excited by the mixing oscillator stage V_4A , B. The cathode follower output voltage is developed across a common cathode resistor and is injected into the cathode of a grounded grid mixer tube V_3B . A double sideband A-M signal is developed in the plate circuit of the mixer tube. The phase of the signal at the plate of mixer V_3B is opposite to that of a signal injected on the control grid of the tube. Cancellation of the carrier is therefore possible by injecting the r-f carrier on this grid via

the "carrier null" potentiometer R_3 . For maximum carrier elimination capacitor C_1 is adjusted to neutralize the capacity feed-through which may occur between V_3A and V_3B . With proper adjustment of C_1 and R_3 a carrier reduction of greater than 40 decibels below maximum SSB signal may be obtained with stability.

The mixing carrier is generated at approximately 498 kc., the frequency of the "20 db attenuation point" of the mechanical filter. The carrier is coupled into the *Crosby* modulator through cathode follower V_4B . A single sideband suppressed carrier signal appears at the output terminals of the mechanical filter and is amplified by a single 5702 pentode stage (V_5), which drives a cathode coupled 6BG7 mixer (V_6). A crystal oscillator (V_{10}) operating on 4002 kc. provides mixing voltage to deliver a 4.5 Mc. sideband signal in the output circuit of the mixer tube. Two double tuned transformers (T_2 and T_3) provide adequate suppression of the mixer voltage. Further signal amplification is obtained at 4.5 Mc. by virtue of a 6BG7 cascode r-f amplifier stage, V_7 .

At this point the signal is mixed in a second cathode coupled mixer stage (V_8) and heterodyned to the 14 Mc. amateur band. The mixing oscillator operates in the 9.7-9.8 Mc. region and uses a 5744 triode (V_{11}) in a *Pierce* circuit. The 14 Mc. SSB signal is developed across a tuned circuit in the plate of the mixer tube. The signal level at this point is quite low, and a second cascode r-f amplifier (V_9) is employed to boost the signal to a level high enough to drive a class AB_1 tetrode linear amplifier. The *RCA* 6524 dual beam amplifier tube requires only 33 volts peak drive signal to develop 50 watts p.e.p., so it was chosen for the final r-f amplifier stage. With the two sections of the tube connected in parallel and 475 volts applied to the plates approximately 40 watts p.e.p. can be obtained from the tube. For maximum stability and freedom from parasitic oscillations, suppressors are placed in the grid and plate leads of the tube and the stage is neutralized.

A simple pi-section output circuit is em-

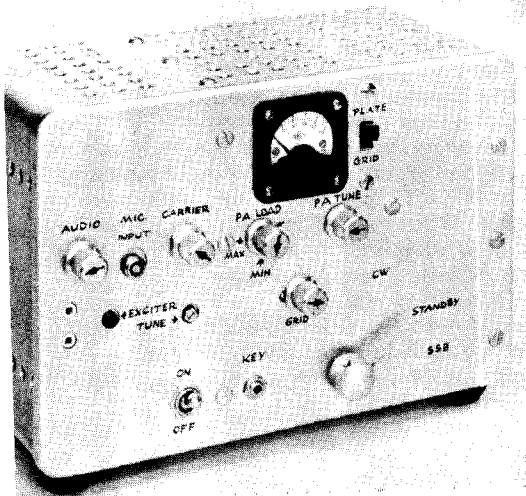

Figure 23

SINGLE SIDEBAND IN A SMALL PACKAGE!

A complete filter-type 14 Mc. single sideband transmitter capable of 40 watts p.e.p. and less than one-half cubic foot in size is described in this section. Completely self contained, this seven pound sideband package is well suited for portable or mobile operation. Primary power source is 115/230 volts, 50-60 cycles. Silicon rectifiers are used in high voltage supply and a 6524 is employed as high level linear amplifier.

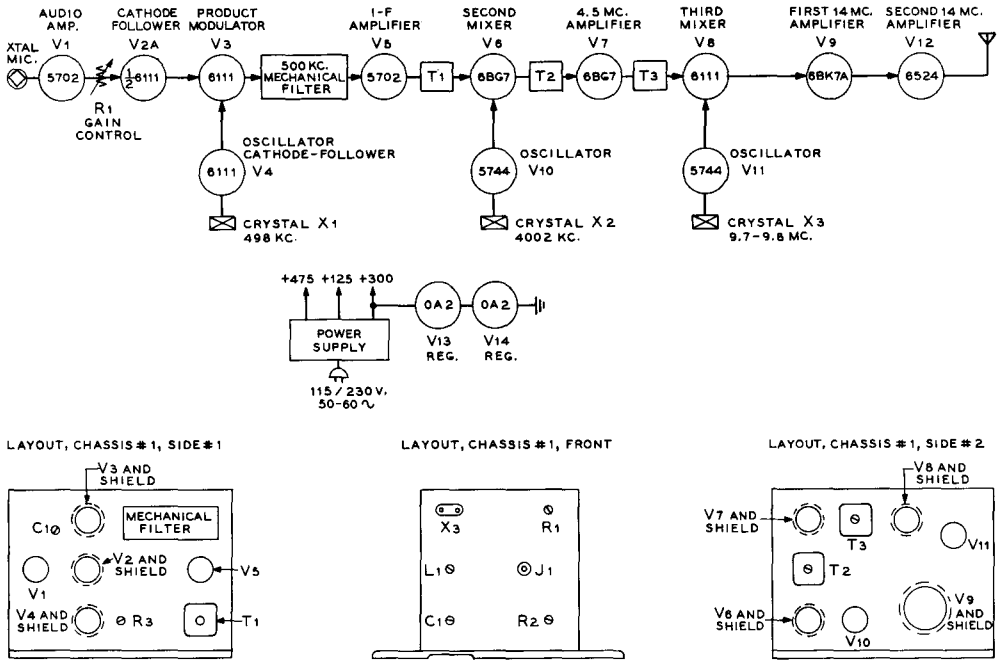

Figure 24

BLOCK DIAGRAM AND PARTS LAYOUT OF 14 MC. SIDEBAND TRANSMITTER

Fourteen tubes (including two voltage regulators) are used in this compact transmitter. A "Crosby" modulator and 500 kc. Collins Mechanical Filter are employed for sideband generation. First frequency conversion is to 4 Mc., and second frequency conversion is to 14 Mc. Layout of major components on both sides and front of special chassis is shown in the illustration.

Figure 25
**OBLIQUE VIEW OF
 AMPLIFIER AND
 EXCITER CHASSIS**

The power amplifier chassis is at the left. The plate coil, plate tuning capacitor and loading switch are in the foreground. Side #1 of the exciter is shown. The inter-chassis area is covered with perforated metal. The tip jacks for the receiver disabling circuit are on the right edge of the chassis. Corners of the mounting base are rounded to permit close fit with drawn aluminum case.

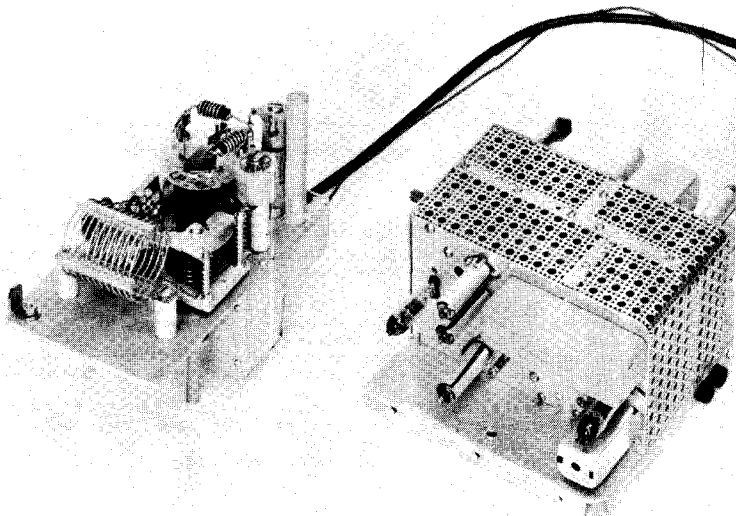

ployed with the linear amplifier stage. In order to conserve space, the usual variable capacitor is omitted from the output side of the network and a rotary switch and selection of fixed capacitors is employed in its place. Proper choice of capacitors permits the transmitter to be matched to 52- or 72-ohm transmission lines having s.w.r. values as great as 2.5/1.

The problem of obtaining the necessary d-c power from a supply that would fit within the small cabinet space was solved by employing a bridge rectifier using the new Sarkes-

Tarzian silicon rectifiers. The forward voltage drop of these rectifiers is of the order of only 1.5 volts and the back resistance is extremely high. Because of the very small size, a great number of rectifiers may be placed in a small area (figure 33). Care must be taken with these rectifiers not to overload them with an accidental short circuit. Peak currents are critical because the small mass of the rectifier element will heat instantaneously and could conceivably reach failure temperature within a time lapse of a few microseconds. The use of

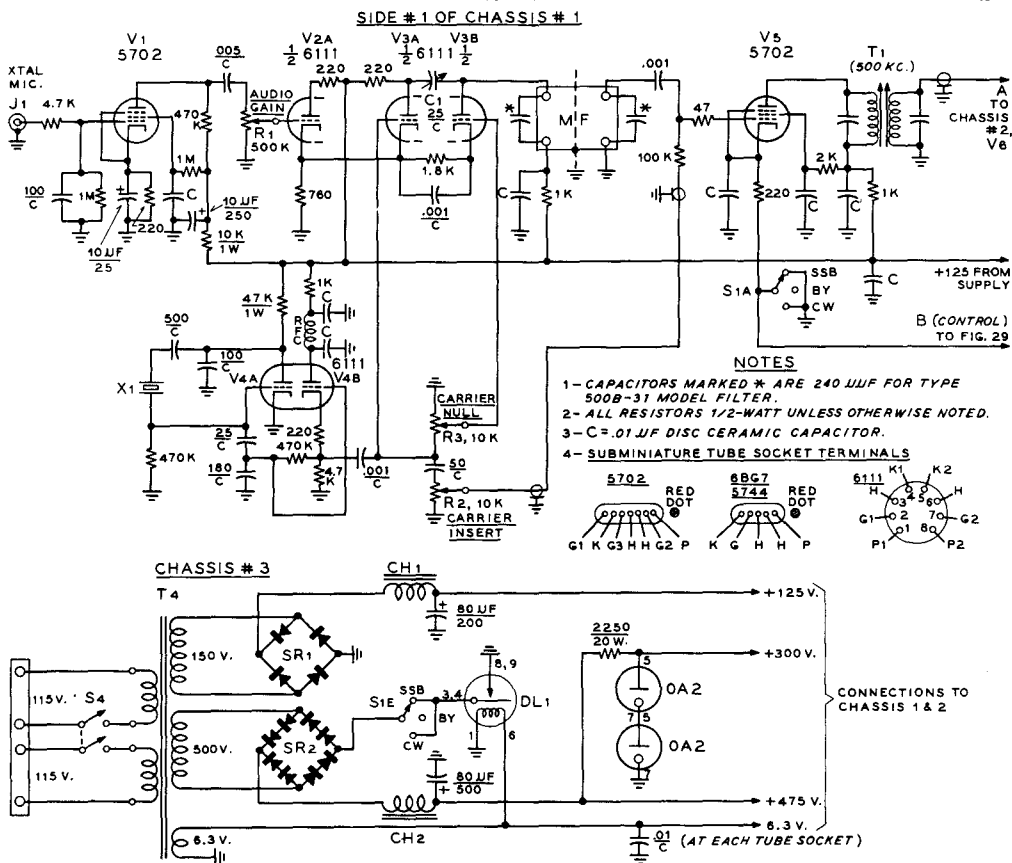

Figure 26

SCHEMATIC, LOW FREQUENCY SECTION AND POWER SUPPLY OF SSB TRANSMITTER

- DL₁—Time delay relay, 45 seconds. Amperite 6N045-T. Normally open.
- T₁—455 kc. miniature i-f transformer. J. W. Miller 12-C9. Remove turns from windings to resonate at 500 kc.
- T₂—150 volt, 125 ma., 500 volt, 125 ma., 6.3 volt, 4 amp. Two 115 volt, 50-60 cycle primary windings. Walgren 3266. Walgren Electric Mfg. Co., Pasadena, Calif.
- CH₁, CH₂—2 henry at 130 ma. Stancor C-2303
- SR₁—Four silicon rectifiers. Max. inverse volts = 280. Sarkes-Tarzian M-500 or 1N1084
- SR₂—Eight silicon rectifiers, two in series for each leg. Max. inverse volts = 280. Sarkes-Tarzian M-500 or 1N1084
- M_F—Collings Mechanical Filter, 3.1 kc. bandwidth, 500 kc. center frequency. Type 500B-31
- X₁—Approximately 498 kc. Frequency chosen to place carrier oscillator at "20 db. down" point on filter curve (see filter data sheet).
- R_FC—2.5 mh. miniature r-f choke. Millen J300-2500.
- S₁—See figure 29

Figure 27
INTERIOR OF LOW FREQUENCY
PORTION OF FILTER TYPE SSB
TRANSMITTER

500 kc. filter and low frequency components are on the bottom deck of the chassis. Small components are mounted between socket pins and miniature tie-point terminals. Interior shield isolates low frequency section from conversion oscillators and 4 Mc. amplifier stages. The "twenty meter" conversion crystal X₁ projects through the front panel of the transmitter (left). Note that transformers are mounted below chassis level to bring overall height even with that of miniature tubes. 6BK7A amplifier tube is also sub-mounted.

Power leads that pass through inter-stage shielding are routed through feed-thru type ceramic insulators (Centralab type FT-1000).

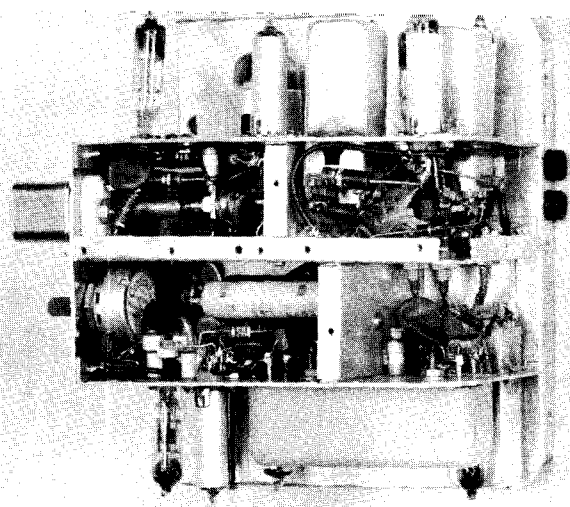

an auxiliary supply for tuning operations, therefore, is highly recommended.

Transmitter Layout and Assembly The transmitter is built in three sections which are held together by a common front panel. The exciter (figure 27), the linear amplifier (figure 31), and the power supply (figure 33) make up these three sections. When the three sections are placed in position they appear as in figure 32. A rear view of the complete transmitter (minus the case) is shown in figure 28. The sections are bolted together and the complete assembly is fastened to the front panel. Because space is at a premium in such a configuration, each chassis is individually designed and shaped to fit the unusual layout. A sketch of the exciter chassis is shown in figure 24. It is formed from two sides and a base. The base mounts in a vertical position in the completed assembly (see figure 28). Side #1 of the exciter chassis contains the low frequency portion of the exciter and can be seen in figure 26, and

the actual placement of major components is shown in figures 25 and 27. The mechanical filter occupies the upper right portion of the deck. Input and output circuits of the filter are isolated by a shield partition that passes across the midsection of the filter. This shield also braces side #1 to the interior full-length shield seen in figure 27. Power leads from this portion of the exciter pass through .001 μ fd. Centralab type FT ceramic feed-through capacitors. These capacitors are employed wherever power leads pass through an interstage shield. Note that coupling transformer T₁ is submounted to bring its height in line with that of the sub-miniature tubes. All components are mounted on this side of the chassis and it is wired before it is attached to the base.

Side #2 of the exciter chassis is attached to the base, and is further braced to side #1 by an end plate and an interstage shield. The 6BK7A socket, and transformers T₂ and T₃ are submounted to bring their height down to that of the sub-miniature tubes. The compon-

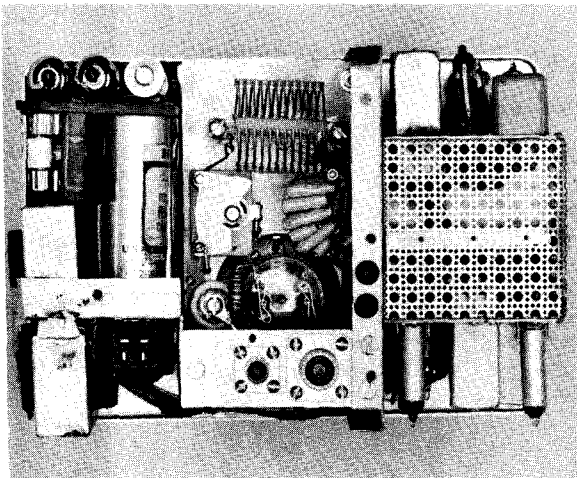

Figure 28
REAR VIEW OF ASSEMBLED SSB
TRANSMITTER

The three sub-assemblies of the transmitter are fastened together and bolted to the front panel. At the left is the power supply section. The a.c. power receptacle is at the bottom of the assembly with the two filter chokes at the left. Above the chokes is the bank of silicon rectifiers with the two voltage regulator tubes and dropping resistor at the top of the supply.

The linear amplifier comprises the center section of the assembly. Antenna and receiver coaxial receptacles are mounted on a small bracket bolted between the outer sections. Plate coil is visible at the top of the chassis with adjustable loading switch to the right.

The right section of the assembly is the exciter, shown in detail in figure 27.

Figure 30
LINEAR AMPLIFIER
AND EXCITER
SECTIONS OF SSB
TRANSMITTER

Left: Linear amplifier is constructed upon an aluminum sheet with grid circuit enclosed by small L-shaped shield box. Low impedance link leads from exciter pass through grommet in box. The coaxial output cable passes through chassis hole to changeover switch. Space to the right of grid enclosure is occupied by meter and time delay relay.

Right: Front view of assembled exciter chassis shows main panel controls. Chassis mounts in vertical position in final assembly. "Twenty meter" conversion crystal socket is at top, left, of front of assembly.

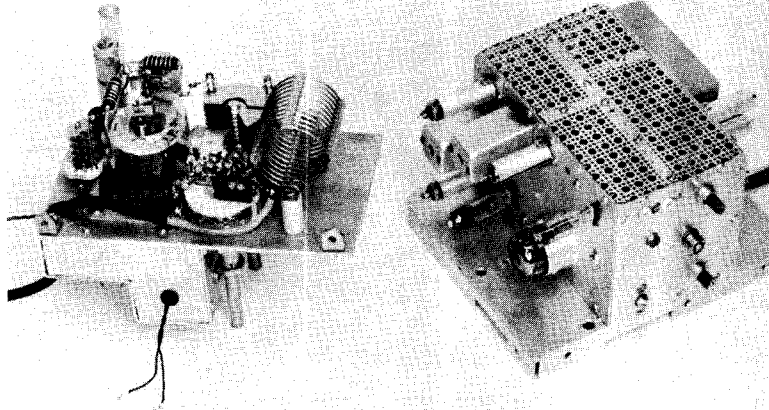

clearly visible in figure 32. The clearance space provided by the "step" is occupied by the "SSB-standby-CW" switch S_1 which is mounted to the panel in close proximity to the grid circuit components of the amplifier stage. The important leads to the control switch pass out of the grid compartment through ceramic feed through capacitors mounted on the wall of the "step" shield. The coaxial r-f output lead and the grid bias lead also pass through this shield and may be seen in figure 32.

Figure 31 provides a close-up of the interior section of the amplifier chassis. Grid coil L_3 is affixed to a polystyrene insulator and is mounted to the side of the chassis-box. Neutralizing capacitor C_3 is placed on a small polystyrene plate adjacent to the 6524 amplifier tube. Plate r-f choke is next to C_3 , and the 5KV plate blocking capacitor is supported between the top end of the choke and the stator of tuning capacitor C_1 . The plate inductor L_1

occupies the far end of the chassis. Pi-network switch S_2 is placed next to the tuning capacitor, and the various padding capacitors are mounted directly on the back of the switch section.

Power supply chassis #3 is attached to the front panel, and the weight of the supply is supported by a sheet metal screw run through the rear of the case into the supply chassis after final assembly. The power supply components are mounted upon a phenolic board which in turn is fastened to the aluminum chassis frame. The silicon rectifiers are held in position by fuse clips mounted on the boards and are placed so that they obtain the maximum possible ventilation. The primary power plug is placed on the rear of the supply chassis and projects through a hole cut in the case of the transmitter. The time delay relay DL-1 is mounted on the side of the amplifier chassis and may be seen in figure 31. The small bias battery for the amplifier stage fits below this space.

Transmitter Wiring It is important that no low frequency energy pass around the mechanical filter as spurious

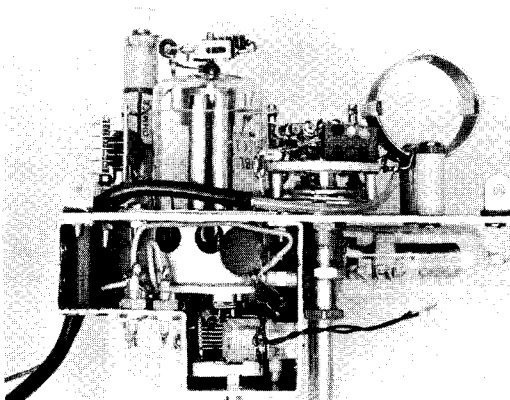

Figure 31
INTERIOR VIEW OF LINEAR
AMPLIFIER GRID COMPARTMENT

Time delay relay is mounted on side of grid box, occupying space between the panel meter and plate tank assembly. The grid coil and tuning capacitor can be seen below the tube socket. Neutralizing capacitor is made from Johnson 30M8 with every third plate removed, but capacitor listed in parts list of figure 29 is satisfactory.

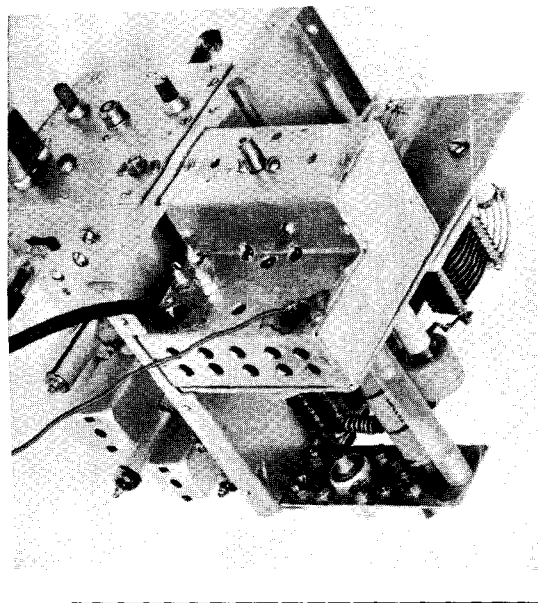

Figure 32
COMPLETE R-F ASSEMBLY OF 20
METER SSB TRANSMITTER

The two r-f units are bolted together in this view. The power supply chassis mounts on the right-hand edge of this assembly. Bias batteries fit in the lower area of the center unit, while plate meter fits into upper space in front of time delay relay. Compare this view with figure 23. This photo is taken from the right front, looking upward at the assembly.

leakage will deteriorate the sideband and carrier suppression to a great degree. Power leads are therefore bypassed with feed through type ceramic capacitors at each partition. Several circuits (V_1B , V_2 , V_3 , V_7 , and V_8) are of the "hot cathode" type in which r-f voltage appears on the cathode of the tube. It is very necessary, therefore, to bypass the filament lead of these tubes to prevent a signal leakage path along the common filament wiring.

Bypass capacitors are placed directly at the tube socket pins to conserve space and all wiring is short and direct. Coil L_1 (14 Mc. mixer plate coil) is mounted within the chassis assembly on a small bracket and a short extension shaft is soldered to the slug to permit circuit adjustment from the front panel. All wiring must be checked for opens, shorts, transpositions, and accidental grounds before power is applied to the transmitter.

Testing the Transmitter

The transmitter should be tested in sections before it is assembled in the case. The use of an auxiliary power supply is recommended. The exciter section should be tested first. A one kilocycle audio signal of low harmonic content is applied to the microphone jack J_1 . "Carrier insert" potentiometer R_2 is set at zero (ground end) and the antenna of a receiver capable of tuning to 500 kc. is attached to point A, figure 26. Before the audio signal is applied, "carrier null" potentiometer R_3 and neutralizing capacitor C_1 are adjusted for minimum signal at the crystal frequency of 498 kc. When the audio level is advanced an unmodulated carrier should be heard in the receiver. The frequency of the carrier will be

the crystal frequency plus the frequency of the audio signal. (i.e.; a 2 kc. audio signal will produce a carrier frequency of 500 kc.). The carrier may be observed on an oscilloscope as described in chapter 17 and audio signal level and null adjustments are varied to reduce the residual "ripple" modulation of the carrier.

Conversion crystal X_2 and tubes V_6 , V_7 , V_8 , and V_{10} are inserted in the proper sockets and the receiver is tuned to 4.5 Mc. and coupled to the secondary winding of T_3 . Transformer T_1 , T_2 , and T_3 are adjusted for maximum sig-

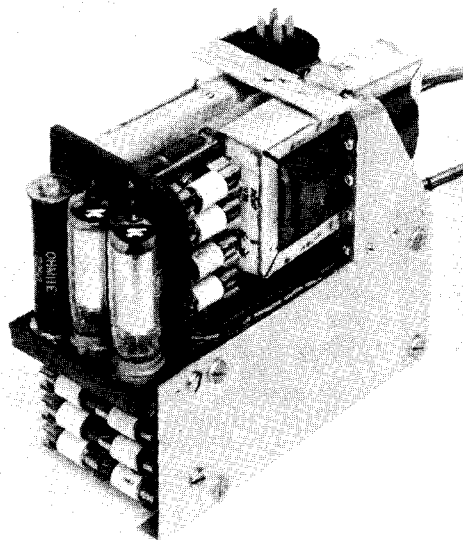

Figure 33
COMPACT SILICON POWER SUPPLY
RUNS ENTIRE TRANSMITTER

Miniature silicon rectifiers permit the complete power supply to be built in extremely small space. Rectifiers are mounted in fuse clips bolted to phenolic board. Power transformer occupies bottom area of assembly and is fastened to aluminum assembly plate by the four bolts in the foreground. Primary power plug can be seen at top of unit, with the two filter chokes mounted back-to-back on an arm of the assembly plate. Voltage regulator tubes and dropping resistors are in the foreground.

Figure 34
"DUPLEX" TRANSMITTER-RECEIVER
FOR 220 MC. RADIO LINK

The width of the amateur 220 Mc. band permits simultaneous duplex transmission between two remote points. This compact VHF package contains a complete 220 Mc. "Radio Link." A crystal controlled transmitter operates on 224.6 Mc. The receiver operates at a frequency of 220.1 Mc. Signal from the transmitter acts as local oscillator for the i-f signal of 4.5 Mc.

The complete station is housed in single steel cabinet. Transmitter section is at left with crystal mounted on panel. Receiver section is at right with power supply occupying lower portion of cabinet. Transmitter may be tone modulated for i.c.w. transmission.



nal level at 4.5 Mc. If a broadband oscilloscope, such as the *Heathkit O-11* is at hand, the signal may be observed visually and the audio level may be set for minimum carrier modulation. When monitored in the receiver the 4.5 Mc. signal should be a pure carrier with little or no tone modulation. When audio gain control R_1 is retarded, the signal should gradually weaken and disappear. After satisfactory operation is obtained at this frequency, crystal X_3

and tubes V_0 and V_{11} are placed in their sockets. Capacitor C_1 (figure 29) is tuned for maximum SSB signal in the 14 Mc. band. The interstage coupling transformers are peaked for maximum sideband signal and the receiver may be used for monitoring purposes. Voice modulation of the transmitter should be sharp and clean. The carrier may be inserted for test purposes by advancing potentiometer R_2 .

The next step is to check the operation of

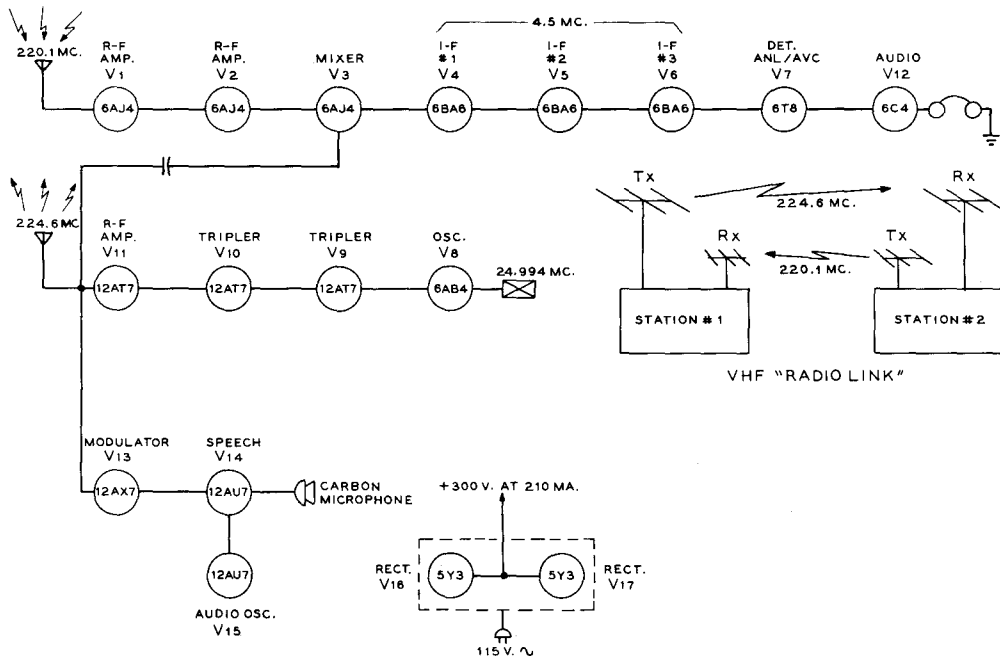

Figure 35
BLOCK DIAGRAM OF 220 MC. TRANSMITTER-RECEIVER

Seventeen tubes are employed in the VHF station. The receiver has two grounded grid r-f stages for maximum sensitivity. Local oscillator injection is provided from the transmitter. Three 4.5 Mc i-f stages provide excellent gain and adequate selectivity. Transmitter is crystal controlled from 25 Mc. crystal and is plate modulated. Power supply provides 300 volts at 210 milliamperes. Transmitter draws 80 milliamperes, receiver draws 75 milliamperes, and modulator draws approximately 45 milliamperes under 100% modulation. Speech system is designated to be used with high gain mobile-type carbon microphone.

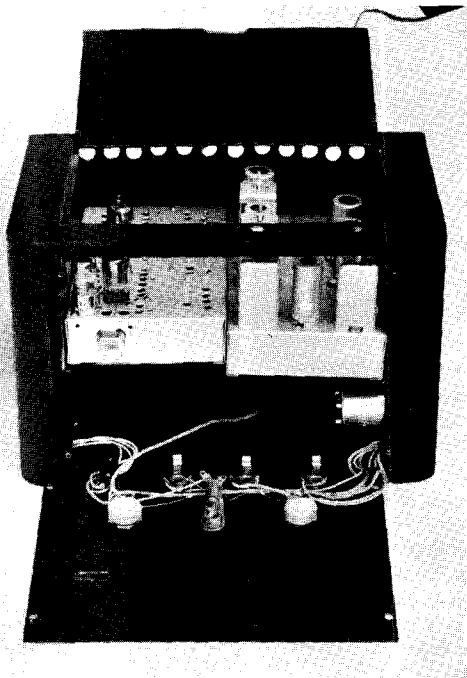

Figure 36

**REMOVAL OF FRONT PANEL SHOWS
PLACEMENT OF R-F CHASSIS**

The receiver and transmitter sections are bolted together to form a single unit which sits near the top edges of the power transformer and modulator chassis. Power supply chassis is bolted to cabinet "on edge" along left hand side, and modulator chassis is attached in the same fashion along the right hand side of the cabinet. Ventilation holes are drilled along upper edge of rear portion of cabinet.

the linear amplifier stage. Bias voltage should be applied to the 6524 and meter switch S_2 set to the grid position. With full carrier insertion, one or two milliamperes of grid current will flow. The stage is neutralized by adjusting capacitor C_2 for minimum grid current fluctuation as the plate circuit is tuned through resonance. A dummy load is then attached to the antenna receptacle (J_2) and the amplifier stage tuned in the usual manner. *Make sure* that plate voltage is never removed when excitation is applied to the tube as the screen current will increase to such a value as to endanger the tube. *Always* remove the screen lead when you remove the plate voltage. When the carrier is nulled out, the resting plate current of the linear amplifier will be about 20 ma., rising to about 100 ma. under voice peaks. No grid current should be indicated under these conditions.

28-5 A Duplex Transmitter-Receiver for 220 Mc.

Duplex operation is permitted in the 220 Mc. amateur band and opens interesting possibilities for unusual and novel forms of equipment. This class of operation consists of two one-way communication links separated in frequency from each other sufficiently to permit interference-free operation. The width of the 220 Mc. band permits placing one link at the low frequency end of the band and the other link near the high frequency end of the band without the danger of excessive interference between the links.

Shown in figure 35 is the block diagram of a transmitter-receiver unit designed to serve as one end of a typical duplex communication link. Transmission takes place on 224.6 Mc., and reception takes place on 220.1 Mc. The frequency separation between the two links is 4.5 Mc. At the opposite end of the link, transmission takes place on 220.1 Mc., and reception takes place on 224.6 Mc.

The complete duplex station is built within a single cabinet and employs a common power supply. Separate antennas are used for transmission and reception, and communication is maintained in the same manner as in the case of a "land-line," that is, simultaneous reception and transmission are possible.

Transmitter-Receiver Circuitry

The schematic of the transmitter - receiver is given in figure 37 and figure 38. The receiver section employs eight tubes in a superheterodyne circuit having two grounded grid r-f amplifier stages (figure 35). The intermediate frequency of the receiver is 4.5 Mc. and three stages of i-f amplification are used. Since the frequency separation of the two links is 4.5 Mc. it is feasible to employ the signal from the transmitter portion of the unit as the injection frequency for the first mixer of the receiver. Thus with the use of two properly chosen transmitter crystals (one at each end of the duplex link) the two transmitter-receivers are locked on frequency and tuning of the receivers is unnecessary. The transmission frequency at each end of the circuit controls the frequency of reception of the receiver portion of the transmitter-receiver.

Two 6AJ4 tubes are used in the receiver as grounded grid r-f amplifier stages. The gain per stage is quite low but is sufficient to overcome the noise level of the mixer tube (V_3). R-f energy from the transmitter section pro-

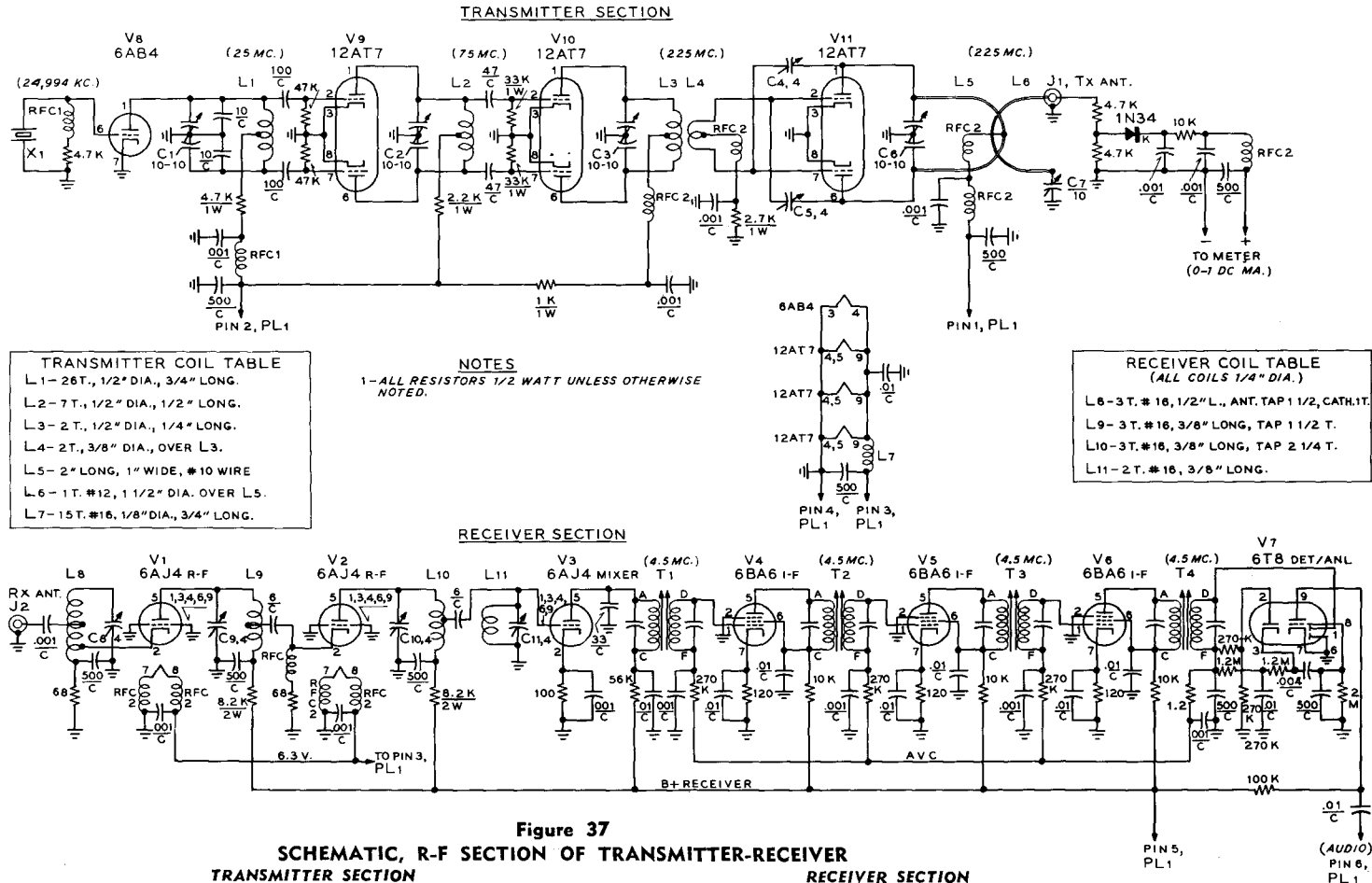

TRANSMITTER SECTION

RECEIVER SECTION

TRANSMITTER COIL TABLE

L1—26T., 1/2" DIA., 3/4" LONG.
 L2—7 T., 1/2" DIA., 1/2" LONG.
 L3—2 T., 1/2" DIA., 1/4" LONG.
 L4—2 T., 3/8" DIA., OVER L3.
 L5—2" LONG, 1" WIDE, #10 WIRE
 L6—1 T. #12, 1 1/2" DIA. OVER L5.
 L7—15 T. #16, 1/8" DIA., 3/4" LONG.

NOTES
 1—ALL RESISTORS 1/2 WATT UNLESS OTHERWISE NOTED.

RECEIVER COIL TABLE
 (ALL COILS 1/4" DIA.)

L8—3 T. #16, 1/2" L., ANT. TAP 1 1/2, CATH. IT.
 L9—3 T. #16, 3/8" LONG, TAP 1 1/2 T.
 L10—3 T. #16, 3/8" LONG, TAP 2 1/4 T.
 L11—2 T. #16, 3/8" LONG.

Figure 37
SCHEMATIC, R-F SECTION OF TRANSMITTER-RECEIVER

- TRANSMITTER SECTION**
 C₁, C₂, C₃, C₅—10-10 μμfd. Johnson 11MB11
 C₄, C₆—4 μμfd. Erie 3139-F
 C₇—10 μμfd. Johnson 9M11
 RFC₁—Ohmite Z-28 r-f choke
 RFC₂—Ohmite Z-235 r-f choke
 X₁—24,944 kc. crystal. Precision Crystal Lab., Santa Monica, Calif.
- RECEIVER SECTION**
 C₈, C₉, C₁₀, C₁₁—4 μμfd. Erie 3139-F
 RFC₃—Ohmite Z-235 r-f choke
 T₁-T₄—4.5 Mc. interstage i-f transformer. J. W. Miller 1466
 PL—6 contact receptacle. Cinch-Jones P-306-AB

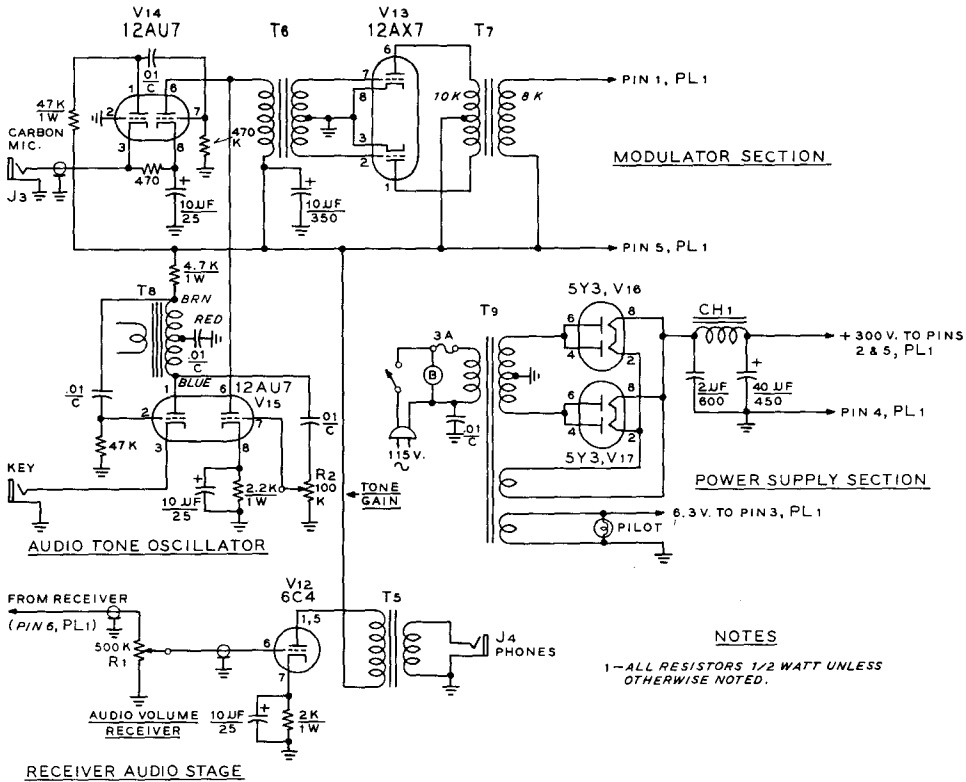

Figure 38

SCHEMATIC, AUDIO AND POWER SUPPLY SECTIONS OF TRANSMITTER-RECEIVER

- T₅, T₈—10K pri., 4 ohm sec. Stancor A-3879
- T₆—10K pri., Pri. to 1/2 sec. = 2:1. Stancor A-4713
- T₇—10 pri., 8K sec. Stancor A-3845
- T₉—360-0-360 volts at 200 ma., 5 v. at 6 amp., 6.3 v. at 9 amp. Stancor P-8351
- CH₁—2 henry at 200 ma. Stancor C-2325
- B—Miniature blower motor and fan, 115 volts

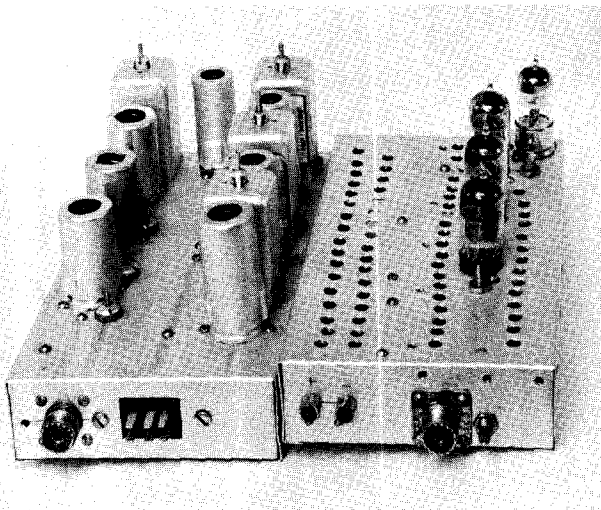
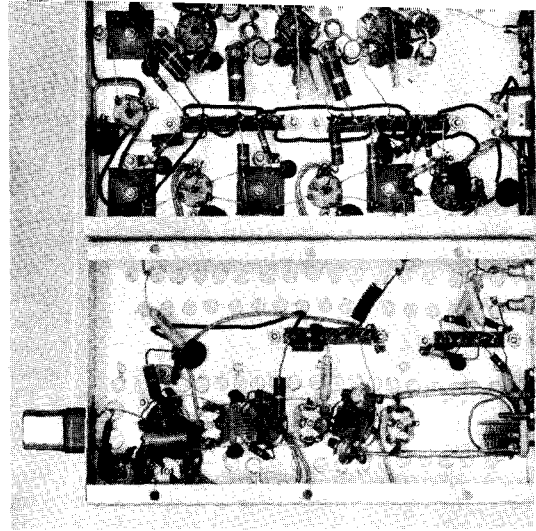

Figure 39
REAR VIEW, R-F DECKS OF TRANSMITTER-RECEIVER

Receiver deck is at the left and transmitter deck is at the right. The two chassis are bolted together to form one unit. Across the back lip (left to right) are; Receiver antenna receptacle, power plug PL₁, meter terminals, transmitter antenna receptacle, and transmitter loading capacitor. Rows of 1/4" holes are drilled in the transmitter chassis to improve ventilation of the rectifier area under the chassis.

Figure 40
UNDER-CHASSIS VIEW, R-F DECKS
OF TRANSMITTER-RECEIVER

Small components of both sections are mounted between tube socket pins and phenolic terminal strips mounted at center of chassis. Small copper shields are placed across center of 6AJ4 r-f tube sockets of the receiver. Shield plate made of perforated aluminum sheet is placed over bottom of transmitter chassis to reduce injection voltage to receiver mixer stage. Neutralization capacitors of transmitter amplifier stage are mounted directly across socket on either side of the grid coil.



vides the proper mixing voltage for this stage. Three stages of 6BA6 amplifiers at 4.5 Mc. comprise the i-f section of the receiver. A-v-c is applied to each stage. A 6T8 multi-purpose tube (V_7) is employed as diode detector, a-v-c rectifier, noise limiter, and first audio stage.

The transmitter section is mounted upon a separate chassis. A 6AB4 triode oscillator (V_8) operates on 24.994 Mc. The plate circuit of this stage is split to provide balanced drive to a push-pull 12AT7 tripler, which in turn

drives a second 12AT7 tripler stage to 224.6 Mc. All stages employ capacity coupling. A third 12AT7 (V_{11}) is used as a push-pull neutralized amplifier at 224.6 Mc. The plate circuit of this stage is a "hair pin" inductance (L_5) tuned by a miniature butterfly capacitor C_6 . Inductive coupling is employed between the driver stage (V_{10}) and the amplifier, and between the amplifier and the antenna circuit. A 1N34 germanium diode serves as a r-f voltmeter in the antenna circuit for transmitter tuning purposes.

The transmitter modulator, audio tone oscillator, and receiver audio amplifier stage are mounted upon another chassis (figure 38). The modulator uses two tubes. A 12AU7 (V_{14}) serves as a two stage resistance coupled speech amplifier, and a 12AX7 (V_{13}) is used as a class B modulator. The speech amplifier is designed to be used with a mobile-type carbon microphone. M-c-w transmission is permissible in the 220 Mc. band and a 12AU7 (V_{15}) audio oscillator has been added for this purpose. The oscillator may be keyed for code transmissions.

The power supply occupies the remaining chassis. It uses two 5Y3 rectifier tubes to provide 300 volts at a current drain of 210 milliamperes. No standby circuits are required since both transmitter and receiver operate simultaneously.

Assembly and Wiring

The complete assembly is housed in a steel cabinet measuring 7" x 12" x 8" (figures 34 and 36). The receiver and transmitter portions are built upon two aluminum chassis measuring 5" x 8" x 1". These chassis are bolted together as seen in figures 39 and 40 and occupy the center section of the cabinet. The power supply and modulator are built upon two similar

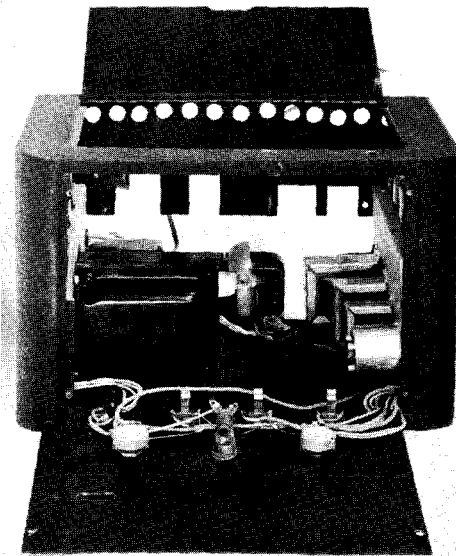

Figure 41
TRANSMITTER-RECEIVER CABINET,
SHOWING POWER SUPPLY
AND MODULATOR

The power supply and modulator chassis are mounted vertically against the side walls of the cabinet. The tubes are mounted on the top edge of the chassis. A small blower motor is placed at the rear of the chassis for continuous duty operation. R-f section sits upon power transformer and is held in position by panel bolts and sheet metal screws passed through rear of cabinet.

chassis that are mounted against the side walls of the cabinet as seen in figure 41. The corners of these chassis are rounded to permit mounting them snugly against the walls of the cabinet. The various tubes are mounted in a vertical position on the upper side of the chassis while the transformers mount on the vertical surface. To the rear of the cabinet is a small blower motor to provide adequate ventilation for protracted operation of the equipment. The various manual controls fasten directly to the main panel of the cabinet and flexible leads are run from them to their respective circuits in the equipment. The r-f deck sits atop the power transformer and the modulation transformer and is held in position by sheet metal screws that pass through the rear wall of the cabinet into the chassis.

The Transmitter Chassis. The placement of major parts on the transmitter chassis may be seen in figures 39 and 40. The crystal oscillator stage is at the front of the chassis with the crystal mounted in a horizontal position, projecting through the front panel of the cabinet. The multiplier stages fall in a line, with the final amplifier stage at the rear of the chassis. The coaxial antenna receptacle J_1 and antenna tuning capacitor C_1 are mounted to the rear wall of the chassis.

Common v.h.f. wiring techniques are employed in the assembly. Short, direct leads in the r-f section are mandatory. The sockets of the two tripler tubes (V_9 and V_{10}) and the amplifier tube (V_{11}) are positioned at an angle of 45 degrees so that a line drawn through pins 1 and 6 is parallel with the front edge of the chassis. The midget butterfly capacitors are mounted in line with the tube sockets, permitting very short leads to be run from the plate pins of the tubes to the stators of the capacitors.

The nine-pin tube sockets are the type that mount from beneath the chassis and have a metal ring encasing the phenolic portion of the socket. The various pins of each socket that must be grounded are bent down and soldered directly to this ring. The grid resistors of V_9 and V_{10} are installed directly between the grid pins and the grounded cathode pins of the tube socket. The coupling capacitors between the stages are placed between the grid pins and the stator rods of the butterfly tuning capacitors. Filament pins 4 and 5 of the nine-pin sockets are grounded to the socket ring and a common filament lead runs between the number 9 pins.

Inductors L_1 and L_2 are made of manufac-

ured coil stock and are mounted to the stator rods of the tuning capacitors. Coils L_3 and L_4 may be wound from enameled wire. The various power leads, decoupling resistors and capacitors are placed clear of the r-f circuitry and the components are mounted upon phenolic tie point strips placed adjacent to the tube sockets. The power leads and meter leads that leave the chassis pass through ceramic feed through capacitors (*Centralab FT-1000*) mounted on the walls of the chassis.

Preliminary Transmitter Adjustments. Transmitter operation may be checked using the power supply shown in figure 38, or any auxiliary supply capable of providing about 200 volts at 80 milliamperes. If the permanent supply is used for tune-up purposes, a 5000 ohm, 10-watt dropping resistor should be placed in series with the B-plus lead to the exciter to protect the tubes in case of misadjustments. Tuned circuit L_1-C_1 may be set to 25 Mc. with the aid of a grid dip oscillator and the 6AB4 oscillator tube and crystal X_1 plugged in their sockets. Proper operation of this and succeeding stages may be checked with a 2 volt, 60 milliampere (pink bead) flash light bulb attached to a small loop of wire which is held in proximity to the coil of the stage being adjusted. When oscillation is obtained, the 12AT7 tripler tube is plugged in its socket and circuit L_2-C_2 set to 75 Mc. with the grid dipper. Plate voltage is again applied and the circuits touched up for maximum bulb brilliance when the pickup loop is held near L_2 . The second tripler tube V_{10} is plugged in the socket and circuit L_3-C_3 adjusted for maximum output at 225 Mc. using the indicator lamp. Spacing of the turns of L_3 may require adjustment to permit resonance. Plate current drawn by these three tubes should be about 70 milliamperes when the dropping resistor is shorted out.

The next step is to neutralize the amplifier stage. This may be done by observing the grid current of V_{11} while capacitors C_4 and C_5 are adjusted. The leads of a high resistance voltmeter are temporarily clipped across the 2.7K grid resistor of the amplifier stage, and the exciter circuits are repeaked for maximum grid voltage reading. Over twenty volts should be obtained. Plate voltage to the amplifier stage is removed for this test. Neutralizing capacitors C_4 and C_5 are now set to minimum capacity and coil L_4 is varied in position with respect to L_3 to obtain maximum grid voltage. The amplifier plate tuning capacitor C_6 is tuned through resonance while grid voltage is observed. If a change in voltage occurs during

the tuning process the settings of capacitors C_4 and C_5 are advanced in unison until no change of grid voltage is noticeable. As the capacity settings are increased (keeping the two settings approximately equal) the "kick" of grid voltage will gradually decrease, until there is either no movement of the meter as C_6 is varied, or else merely a gradual rise of a volt or so as C_6 is swung through its range.

A 6.3 volt, 150 milliampere (brown bead) lamp is now connected to antenna receptacle J_1 and plate voltage is applied to the amplifier stage and exciter. Capacitors C_6 and C_7 are tuned for maximum bulb brilliance. The plate current of the amplifier stage will be close to 30 milliamperes under conditions of maximum output.

Once initial adjustments have been made, a 0-1 d.c. milliammeter may be connected to the r-f voltmeter terminals and the transmitter may be completely tuned by adjusting all resonant circuits for maximum indication of the meter. It is wise, however, to make the preliminary adjustments stage by stage as described above to acquaint the operator with proper transmitter operation.

The Receiver Chassis. The placement of the major components of the receiver chassis may be seen in figures 39 and 40. The line-up of stages forms a "U" on the chassis, passing down one side, across the front and back along the other side. Two six terminal phenolic tie-point strips are mounted along the center line of the chassis, supporting various decoupling and voltage dropping resistors. Layout of the r-f stages may be seen in the under-chassis view of figure 40. A small copper shield plate 1" high and 1½ inches long passes across the center of each socket and is grounded at each end by soldering to the socket retaining screws. The center stud of the socket, and pins 1, 3, 4, 6, and 9 are all soldered to this plate. Tuning capacitors C_8 , C_9 , C_{10} , and C_{11} are mounted close to the tube sockets, and the VHF-type bypass capacitor at the "cold" end of each coil (*Centralab type ZA*) is mounted next to the tuning capacitor. Coils L_8 , L_9 , L_{10} , and L_{11} are mounted between the terminals of the respective tuning capacitor and the adjacent VHF bypass capacitor. Care must be taken to keep the coil leads as short as possible—less than ¼-inch long in any case.

One filament choke of each r-f amplifier stage is grounded to the shield plate and the other choke is bypassed by a disc ceramic capacitor and returns to the common filament lead. Wiring of the i-f stages is straightforward,

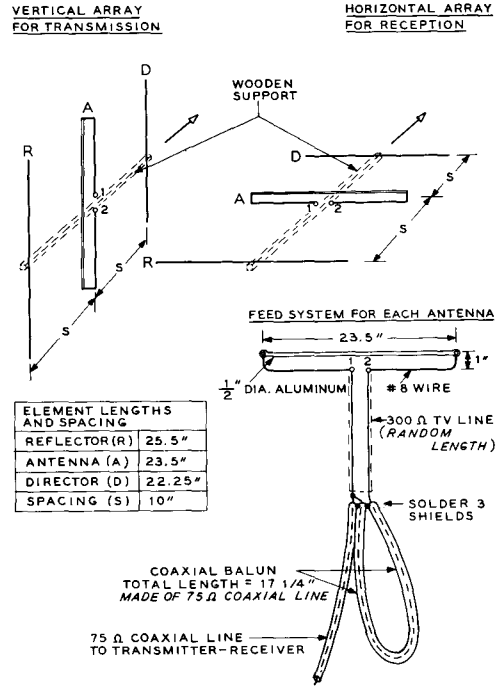

Figure 42
DUAL ANTENNA SYSTEM FOR 220 MC. TRANSMITTER-RECEIVER

The same polarization must be used on each link. This means that polarization of transmission and reception is different at each station. For the companion link to the one illustrated in this drawing, the vertical array should be used for reception, and the horizontal array for transmission.

components being mounted between the socket and i-f transformer terminals and the phenolic tie-point strip. Power leads are terminated at the six prong plug mounted on the rear apron of the chassis.

No connection need be made between the r-f circuit of the transmitter and the mixer stage of the receiver as ample proximity coupling exists. In fact, a shield plate is placed over the bottom of the transmitter chassis to reduce the mixer injection to a tolerable level.

Preliminary Receiver Adjustment. After all wiring is completed, the i-f section of the receiver may be aligned. A 4.5 Mc. tone modulated signal is loosely coupled to the plate pin (#5) of mixer tube V_3 and earphones or an a-c meter connected to the output circuit of audio tube V_7 (Pins 5 and 6 of the power plug). The slug cores of transformers T_1 , T_2 , T_3 , and T_4 are adjusted for maximum signal. The receiver and transmitter sections should be bolted together and the transmitter tuned

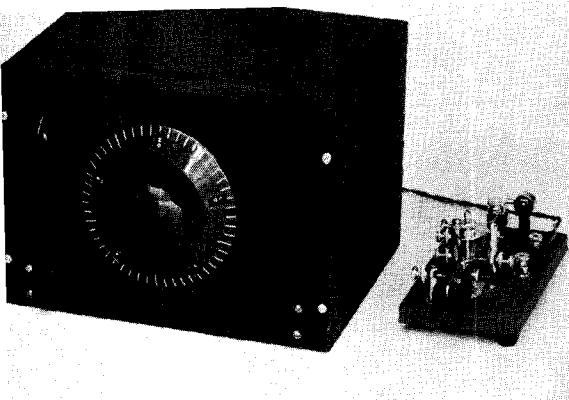

Figure 43
COMPACT VFO PROVIDES HIGH
STABILITY SIGNAL FOR HIGH
FREQUENCY DX BANDS

This small v.f.o. employs latest techniques to achieve stable, drift-free signal. Only 7½" × 9" × 7" in size, the unit uses a high-C 1.75 Mc. oscillator followed by a cathode follower to achieve a maximum degree of circuit isolation. Buffer tuning and control switch are at left of panel, with large, easily read frequency control dial at center.

up with a dummy load. This will provide injection signal for proper receiver operation at 220.1 Mc. A remote signal (preferably that of the companion unit) should be used as a signal source and the tuned circuits of the r-f amplifiers adjusted for best signal reception. It may be necessary to alter the spacing of coils L_8 - L_{11} to provide proper circuit resonance which should occur at about the middle of the tuning range of the associated capacitor.

Modulator and Power Supply Construction. The layout of the modulator and power supply can be seen in figure 41. The units are wired and the control leads are brought out through insulated grommets placed in the end of the chassis. A common ground lead is run from each chassis to the switches and controls mounted upon the front panel. The small blower motor is mounted at the rear of the cabinet and a row of ⅜" ventilation holes is drilled around the top edge of the cabinet as shown in the photograph. The power supply and modulator should be tested before they are mounted in the cabinet, and the whole assembly should be in operating condition before it is placed within the cabinet. The tone of the audio oscillator (V_{15}) may be varied by placing a capacitor across the primary winding of the oscillator transformer T_5 .

Antenna Installation Two separate antennas are required for duplex operation. To reduce coupling, one link is horizontally polarized and the other link is vertically polarized as illustrated in figure 42. Care must be taken that identical polarization is employed at both ends of each link. Three-element beam antennas are used for each link. A folded dipole and balun system are employed to provide a good match to the coaxial transmission line. After the links have been set up, transmitter and receiver tuning adjustments should be peaked to maximize the signals. It will be found advantageous to experiment with

the position of the antennas to provide maximum signal pickup with a minimum of interference from the local transmitter. In general, the receiver antenna should be oriented for maximum signal from the distant station, and the transmitter antenna should be oriented for minimum local signal pickup. For general use, the two antennas may be attached to the same supporting structure, separated from each other by four or five feet. As with any VHF equipment, time spent in placing the antennas will pay big dividends in system operation.

28-6 A High Stability V.F.O. For the DX Operator

Stability and freedom from drift are the prime requisites of a high quality variable frequency oscillator. To meet the requirements of the discriminating operator the v.f.o. must be stable with respect to warm-up, ambient temperature variations, line voltage shift, vibration, and the presence of a strong r-f field. To achieve these parameters in a unit simple enough for home construction is a large order.

The variable frequency oscillator shown in figures 43, 46, and 47 is a successful attempt to meet these requirements and is recommended to those operators who desire a v.f.o. having a high order of stability and resetability.

Frequency Stability The perfect variable frequency oscillator has the frequency determining elements completely

VOLTAGE MEASUREMENTS, V.F.O.	
SCREEN (PIN 3)	6U8 - 70
CATHODE (PIN 8)	6U8 - 10.5
R-F VOLTS, GRID (PIN 9)	6U8 - 10.3
R-F VOLTS, CATHODE (PIN 8)	6U8 - 9.5
R-F VOLTS, J1, ACROSS 47 OHM RESISTOR	- 6.2

Figure 44
VOLTAGE CHART FOR V.F.O.

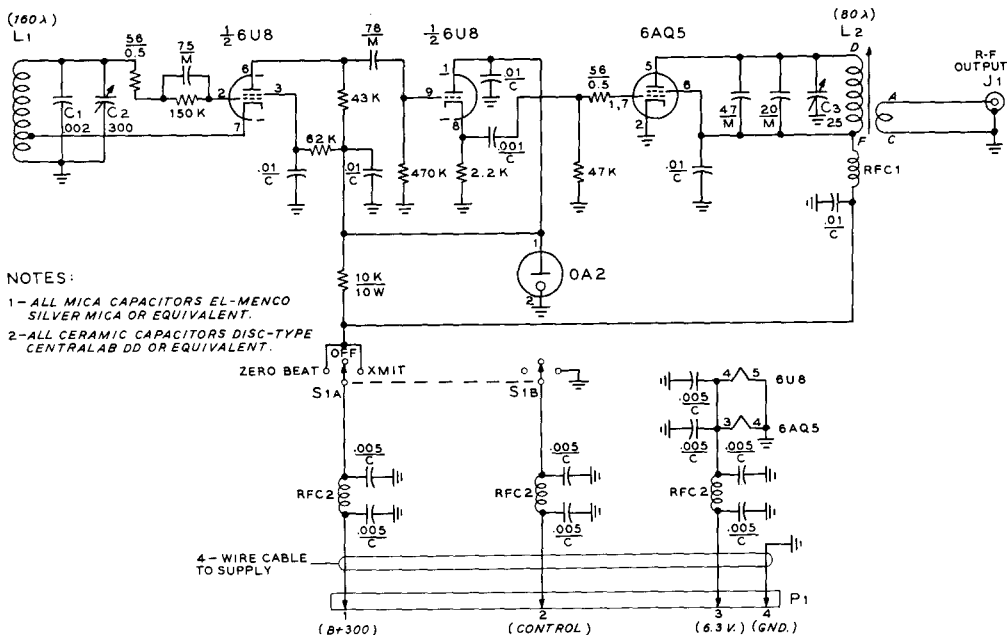

- C₁—0.002 μ fd. Centralab high accuracy capacitor 950-202.
- C₂—300 μ fd. Bud MC-1860
- C₃—25 μ fd. Bud LC-1642
- L₁—17 $\frac{3}{4}$ turns #20 g. $\frac{3}{4}$ " diam., approx. 1" long. (See text) Wind on National ceramic form XR-72. Tap at 4 turns from "cold" end.
- L₂—4.5 Mc. Interstage "TV" transformer. J. W. Miller 1466. Remove secondary winding and replace with 8 turns #22 d.c.c. wound next to primary winding.
- RFC₁—2.5 mh. National R-100
- RFC₂—YHF choke, 500 ma. National R-60

isolated both electrically and physically from the rest of the transmitting equipment. This goal cannot be achieved in practice since a vacuum tube or transistor must be coupled to these circuit elements to maintain oscillation. The coupling of such items deteriorates the electrical isolation of the frequency determining circuit. By the use of proper coupling circuits the effects of the tube or transistor can be minimized.

The frequency determining circuit is also

subject to temperature variations, changes in the relative humidity of the surrounding air, and absorption of heat from nearby objects. By employing temperature and humidity resistive materials and removing as many heat generating components from the vicinity of the frequency determining circuits, a good degree of stability in the v.f.o. may be obtained.

Finally, steps must be taken to ensure that the oscillator of the v.f.o. unit is completely free of parasitics, and that the output waveform

Figure 46

REAR VIEW OF V.F.O. CHASSIS, SHOWING PLACEMENT OF PARTS

Oscillator inductor L₁ is at the left of chassis, separated from the heat producing electron tubes. To right of L₁ is the precision padding capacitor C₁ mounted to the chassis. The main tuning capacitor is firmly affixed to a heavy dural mounting plate bolted to the gear box of the dial drive. The rear of the tuning capacitor is attached to the chassis by a mounting stud. To the right are the three tubes and the output transformer. Directly under the tuning capacitor is the polystyrene chassis plate holding the feed through bushings for the oscillator leads to the under-chassis area. Control switch S₁ is at upper right.

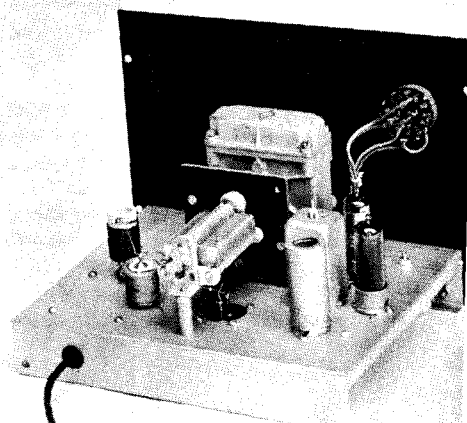

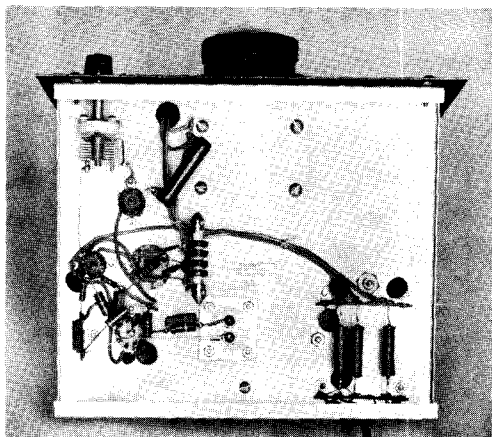

Figure 47
UNDER-CHASSIS VIEW OF
V.F.O. UNIT

Power lead filters are at lower right of chassis, with r-f circuit components at left. All parts are firmly mounted to terminals and tie points to reduce vibration. Power leads are laced. Buffer tuning capacitor C₁ is at upper left.

is low in harmonic content. The variable frequency exciter to be described in this section meets these fundamental requirements.

The V.F.O. Circuit The circuit diagram of the high stability v.f.o.

is shown in figure 45, and the complete physical layout may be seen in figures 46 and 47.

The pentode section of a miniature 6U8 tube is used as the oscillator. The oscillator circuit is tuned to the 160 meter region and consists of a high-Q oscillator coil resonated to the working frequency by a precision ceramic capacitor in parallel with a variable air capacitor. The ceramic capacitor (*Centralab type 950*) has a measured temperature coefficient of less than plus or minus ten parts per million over the temperature range of -40 degrees to plus 60 degrees Centigrade. The use of ordinary ceramic or silver mica capacitors as a substitute for this unit is not recommended, since the temperature coefficient of such units cannot be closely controlled in quantity production.

The oscillator coil, L₁, is wound upon a ceramic coil form that has a very low coefficient of expansion. The coil turns are spaced to ensure low inter-turn capacitance. The wire is wound upon the form under tension and at a relatively high temperature. As the wire cools, it shrinks and tightly clasps the form so that for all practical purposes the wire and the form have the same coefficient of expansion

with regard to temperature changes. This style of winding reduces the possibility of the oscillator developing random frequency jumps with changes in temperature and humidity.

A 56 ohm resistor is inserted in series with the grid lead of the 6U8 oscillator tube. This suppressor eliminates any tendency toward parasitic oscillation that can result in this type of oscillator circuit. The parasitic tends to make fundamental oscillation unstable at certain settings of the oscillator tuning capacitor. This instability may be caused by variations of the inherent inductance of the tuning capacitor at the frequency of parasitic oscillation.

All components of the oscillator circuit are spaced clear of the oscillator tube to prevent heat transfer from the tube to the frequency determining circuit.

The pentode oscillator is R-C coupled to the triode section of the 6U8 which serves as a cathode follower. The input impedance of the cathode follower is extremely high and provides excellent isolation between the oscillator circuit and the output stage. Plate and screen voltage of the oscillator and plate voltage of the cathode follower are regulated by an OA2 gas regulator to provide maximum isolation from power supply fluctuations.

The r-f output of the triode section of the 6U8 is taken from the low impedance cathode circuit and is capacity coupled to a 6AQ5 miniature pentode tube which serves as a frequency doubler to the 80 meter region. The v.f.o. covers the frequency range of 1750 kc. to 1850 kc., and the plate circuit of the 6AQ5 doubler tunes 3500 kc. to 3700 kc. The 80 meter output is 0.8 watt which is more than sufficient to drive a tetrode buffer such as an 807 or 6146. If more output is desired, a 6CL6 may be substituted for the 6AQ5 (with appropriate socket wiring changes) to deliver approximately 2 watts.

One filament terminal of each tube is grounded and the free terminals are bypassed to ground with .005 μ fd. ceramic capacitors. The filament leads then pass through an r-f choke to ensure maximum lead isolation.

Switch S₁ disables the v.f.o. by removing the plate voltage. A second section of the switch opens an auxiliary circuit that can control the power relays of the transmitter. A third position of switch S₁ permits the v.f.o. to be turned on by itself for zero-beat operation.

Transmitter keying for c-w operation is done in the stages following the v.f.o.-exciter to achieve maximum frequency stability and freedom from frequency shift during keying.

Mechanical Design of the V.F.O.

The mechanical design of the variable frequency oscillator is equally important as the electrical design if maximum stability and reliability are to be achieved. Provision must be made for dissipation of the heat generated by the vacuum tubes, and the v.f.o. components should be mounted on a sheet of conducting material which will act as a heat "sink" and will tend to resist rapid changes in the temperature of the components bolted thereto.

The v.f.o. is built upon a cadmium plated steel chassis measuring $7\frac{1}{2}$ " x 9 " x $1\frac{1}{2}$ ". The gear box of the *National HRO*-type dial is bolted to the chassis and the main tuning capacitor C_2 is affixed by its front bearing to a 3 " x 3 " x 0.125 " dural plate held to the capacitor gear box by three long machine screws and three $1\frac{1}{8}$ " metal spacers. The tuning capacitor is driven through a high quality flexible coupling. This coupling should be free of back-lash, and should not permit end pressure on the shaft of the capacitor. A *Johnson 104-250* coupling is recommended. Make sure that the shaft of the gear box and that of the capacitor are perfectly in line as misalignment tends to force a degree of back-lash in the system.

The rear mounting foot of the capacitor is fastened to the steel chassis by means of a long $6/32$ bolt and a 1-inch metal spacer. This assembly provides a very rugged arrangement with a minimum of flexing between the capacitor and the chassis.

Oscillator coil L_1 and the precision ceramic capacitor C_1 are mounted to the chassis to the side of the tuning capacitor as seen in the rear view photograph. The slug of coil L_1 is removed and discarded before the coil is wound. Moveable oscillator slugs are not conducive to any great degree of oscillator stability and this potential source of instability should be taken from the circuit before it can do any damage.

The leads from the oscillator circuit to the 6U8 pentode tube pass through a $1\frac{1}{4}$ " hole cut in the steel chassis. A $\frac{1}{8}$ "-thick square of polystyrene is mounted under this hole and two miniature feedthrough bushings are mounted in the insulating plate. The residual capacity to grounds of these important leads is thereby held to an absolute minimum value.

The vacuum tubes and auxiliary circuits are placed on the opposite side of the tuning capacitor from the sensitive tuned circuit L_1 - C_1 . In front of the oscillator tube is the 80 meter

output coil L_2 , the 6AQ5 socket and the OA2 socket. Switch S_1 is mounted to the front panel directly in front of the 6AQ5. The front panel is held to the chassis by means of four $6/32$ bolts placed in the extreme corners of the front lip of the chassis. The panel is spaced slightly away from the chassis by an extra set of nuts slipped over the bolts before the panel is affixed to the chassis.

All control leads to the v.f.o. unit pass through a four wire cable which enters the under chassis area via a rubber grommet on the back lip of the chassis. Each lead is bypassed with a $.005$ μ fd. ceramic capacitor and is filtered with a low resistance r-f choke. The coaxial output receptacle for the v.f.o. is also mounted on the rear lip of the chassis, directly behind the 6U8 oscillator tube.

Wiring the V.F.O.

The under-chassis area of the v.f.o. should be wired first. Common ground connections are made to the three sockets by means of soldering lugs and lock washers placed beneath one socket retaining nut. The filament leads are wired next. The bypass capacitors for pins 1, 3, and 4 of the 6U8 socket are placed between the socket pins and the grounded center stud of the socket with the shortest possible leads. All components of the 6U8 stage should be mounted solidly in place between adjacent tube pins or to nearby phenolic tie-point terminals. The grid resistor and capacitor of the oscillator section are mounted between pin #2 of the 6U8 socket and the inter-chassis feedthrough insulator in the polystyrene block.

The plate coil of the 6AQ5 doubler stage is made from a 4.5 Mc. sound TV i-f transformer. The secondary winding and tuning capacitor are removed and a link winding of 8 turns is wound on the form, closely spaced to the primary winding. The transformer is then replaced in the shield can and mounted atop the chassis. The r-f choke in the plate circuit of the doubler stage is mounted between two terminals of a phenolic tie-point strip bolted to one of the transformer lugs.

The power supply r-f filter circuits are placed on two four terminal tie-point strips mounted in the far corner of the chassis. The bypass capacitors are mounted between the individual terminal lugs and the adjacent ground connections of the strip and the r-f chokes are mounted between the strips.

After the under-chassis wiring is completed the wiring atop the chassis may be done. The leads of the tuned circuit are made of #12 tinned wire. The coil is wound with #20

increasing the capacitance of C_2 will provide full coverage of the 80 meter band. In either case, it will be necessary to juggle the turns on L_1 to obtain the correct tuning range.

Operating Check of the V.F.O. When completed the v.f.o. should be placed in the operating position and run for a period of several hours. During this time, the frequency of the v.f.o. should be compared against a known standard such as a 100 kc. crystal, or Standard Frequency Station WWV. Under normal conditions the v.f.o. will have a small positive initial warm-up drift of less than 100 cycles on 80 meters. It should settle down after a period of time and remain relatively stable if the temperature of the room is constant.

Temperature stabilization may be accomplished by the addition of a small value of

negative coefficient capacitance to the tuning circuit. This is a cut-and-try process and is not recommended unless the builder has plenty of time and previous experience with the task. It is not really required unless the oscillator is operated under extremes of room temperature.

The last step is to place the v.f.o. in the metal cabinet. The unit should not be operated out of the cabinet as the enclosure affords some degree of shielding from the r-f field of the transmitter. The rear of the chassis is fastened to the bottom of the cabinet by two sheet metal screws passed from the under side of the bottom of the cabinet up into the rear lip of the chassis. To prevent frequency changes during operation the lid of the cabinet should be fastened shut by means of two sheet metal screws run through the front corners of the lid into the cabinet.

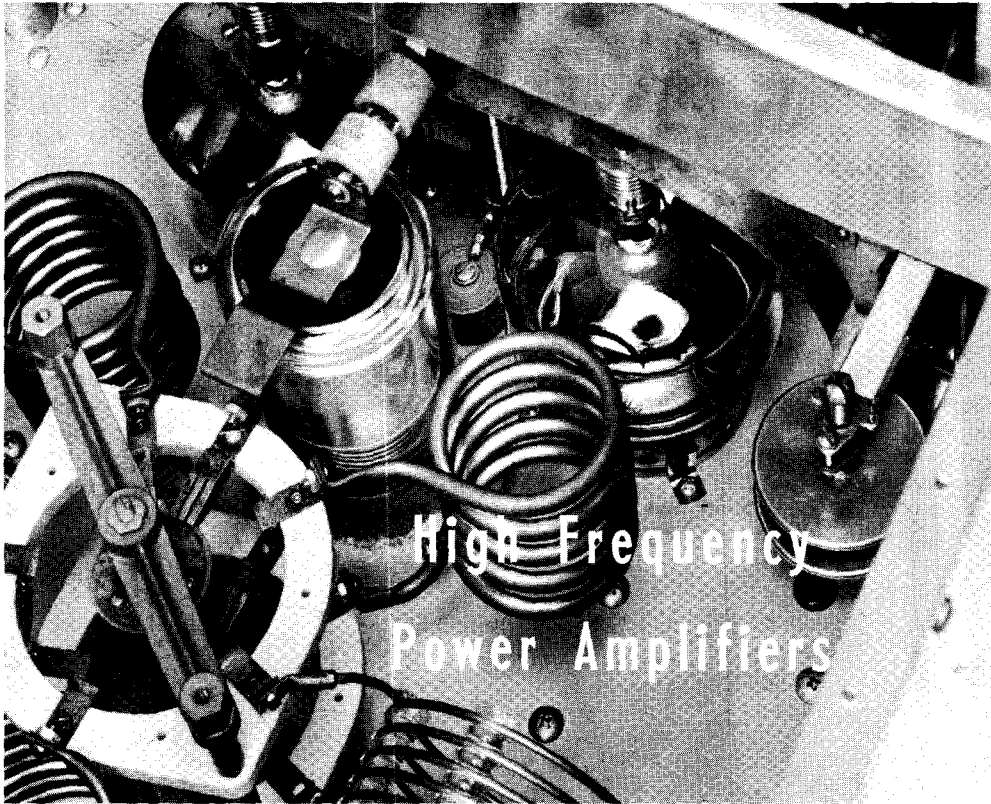

The trend in design of transmitters for operation on the high frequency bands is toward the use of a single high-level stage. The most common and most flexible arrangement includes a compact bandswitching exciter unit, with 15 to 100 watts output on all the high-frequency bands, followed by a single power amplifier stage. In many cases the exciter unit is placed upon the operating table, with a coaxial cable feeding the drive to the power amplifier, although some operators prefer to have the exciter unit included in the main transmitter housing.

This trend is a natural outgrowth of the increasing importance of v-f-o operation on the amateur bands. It is not practical to make a quick change in the operating frequency of a transmitter when a whole succession of stages must be returned to resonance following the frequency change. Another significant factor in implementing the trend has been the wide acceptance of commercially produced 75 and 150-watt transmitters. These units provide r-f

excitation and audio driving power for high-level amplifiers running up to the 1000-watt power limit. The amplifiers shown in this chapter may be easily driven by such exciters.

29-1 Power Amplifier Design

Choice of Tubes Either tetrode or triode tubes may be used in high-frequency power amplifiers. The choice is usually dependent upon the amount of driving power that is available for the power amplifier. If a transmitter-exciter of 100-watt power capability is at hand (such as the *Heath TX-1*) it would be wise to employ a power amplifier whose grid driving requirements fall in the same range as the output power of the exciter. Triode tubes running 1-kilowatt input (plate modulated) generally require some 50 to 80 watts of grid driving power. Such a requirement is easily met by the output level of the 100-watt transmitter which should

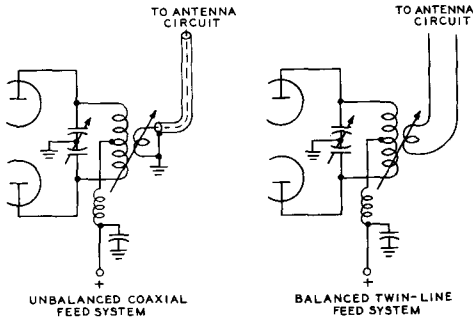

Figure 1
LINK COUPLED OUTPUT CIRCUITS
FOR PUSH-PULL AMPLIFIERS

be employed as the exciter. Tetrode tubes (such as the 4-250A) require only 10 to 15 watts of actual drive from the exciter for proper operation of the amplifier stage at 1-kilowatt input. This means that the output from the 100-watt transmitter has to be cut down to the 15 watt driving level. This is a nuisance, as it requires the addition of swamping resistors to the output circuit of the transmitter-exciter. The triode tubes, therefore, would lend themselves to a much more convenient driving arrangement than would the tetrode tubes, simply because their grid drive requirements fall within the power output range of the exciter unit.

On the other hand, if the transmitter-exciter output level is of the order of 15-40 watts (the *Johnson Ranger*, for example) sufficient drive for triode tubes running 1-kilowatt input would be lacking. Tetrode tubes requiring low grid driving power would have to be employed in a high-level stage, or smaller triode tubes requiring modest grid drive and running 250 watts or so would have to be used.

Power Amplifier Design—Choice of Circuits

Either push-pull or single ended circuits may be employed in the power amplifier. Using modern tubes and properly designed circuits, either type is capable of high efficiency operation and low harmonic output. Push-pull circuits, whether using triode or tetrode tubes usually employ link coupling between the amplifier stage and the feed line running to the antenna or the antenna tuner.

It is possible to use the link circuit in either an unbalanced or balanced configuration, as shown in figure 1, using unbalanced coaxial line, or balanced twin-line.

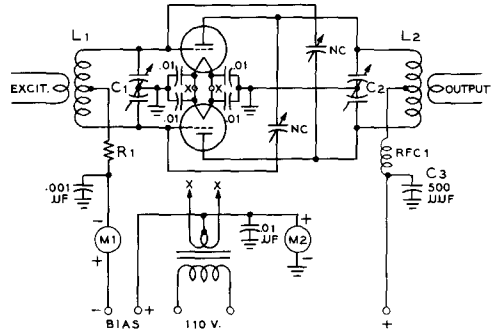

Figure 2
CONVENTIONAL PUSH-PULL
AMPLIFIER CIRCUIT

The mechanical layout should be symmetrical and the output coupling provision must be evenly balanced with respect to the plate coil

- C₁—Approx. 1.5 μfd. per meter of wavelength per section*
- C₂—Refer to plate tank capacitor design in Chapter 11*
- C₃—May be 500 μfd., 10,000-volt type ceramic capacitor*
- NC—Max. usable capacitance should be greater, and min. capacitance less than rated grid-plate capacity of tubes in amplifier. 50% greater air gap than C₁.*
- R₁—100 ohms, 20 watts. This resistor serves as low Q r-f choke.*
- RFC—All-band r-f choke suitable for plate current of tubes*
- M₁-M₂—Suitable meters for d-c grid and plate currents*
- All low voltage .001 μfd. and .01 μfd. by-pass capacitors are ceramic disc units (Centralab DD or equiv.)*
- L₁—50-watt plug-in coil, center link*
- L₂—Plug-in coil, center link, of suitable power rating.*

Common technique is to employ plug-in plate coils with the push-pull amplifier stage. This necessitates some kind of opening for coil changing purposes in the "electrically tight" enclosure surrounding the amplifier stage. Care must be used in the design and construction of the door for this opening or leakage of harmonics through the opening will result, with the attendant TVI problems.

Single ended amplifiers may also employ link-coupled output devices, although the trend is to use pi-network circuits in conjunction with single ended tetrode stages. A tapped or otherwise variable tank coil may be used which is adjustable from the front panel, eliminating the necessity of plug-in coils and openings into the shielded enclosure of the amplifier. Pi-network circuits are becoming increasingly popular as coaxial feed systems are coming into use to couple the output circuits of transmitters directly to the antenna.

29-2 Push-Pull Triode Amplifiers

Figure 2 shows a basic push-pull triode amplifier circuit. While variations in the method of applying plate and filament voltages and bias are sometimes found, the basic circuit remains the same in all amplifiers.

Filament Supply The amplifier filament transformer should be placed right on the amplifier chassis in close proximity to the tubes. Short filament leads are necessary to prevent excessive voltage drop in the connecting leads, and also to prevent r-f pickup in the filament circuit. Long filament leads can often induce instability in an otherwise stable amplifier circuit, especially if the leads are exposed to the radiated field of the plate circuit of the amplifier stage. The filament voltage should be the correct value specified by the tube manufacturer when measured *at the tube sockets*. A filament transformer having a tapped primary often will be found useful in adjusting the filament voltage. When there is a choice of having the filament voltage slightly higher or slightly lower than normal, the higher voltage is preferable. If the amplifier is to be overloaded, a filament voltage slightly higher than the rated value will give greater tube life.

Filament bypass capacitors should be low internal inductance units of approximately .01 μ fd. A separate capacitor should be used for each socket terminal. Lower values of capacitance should be avoided to prevent spurious resonances in the internal filament structure of the tube. Use heavy, shielded filament leads for low voltage drop and maximum circuit isolation.

Plate Feed The series plate voltage feed shown in figure 2 is the most satisfactory method for push-pull stages. This method of feed puts high voltage on the plate tank coil, but since the r-f voltage on the coil is in itself sufficient reason for protecting the coil from accidental bodily contact, no additional protective arrangements are made necessary by the use of series feed.

The insulation in the plate supply circuit should be adequate for the voltages encountered. In general, the insulation should be rated to withstand at least four times the maximum d-c plate voltage. For safety, the plate meter should be placed in the cathode return lead, since there is danger of voltage breakdown between a metal panel and the meter

movement at plate voltages much higher than one thousand.

Grid Bias The recommended method of obtaining bias for c-w or plate modulated telephony is to use just sufficient fixed bias to protect the tubes in the event of excitation failure, and to obtain the rest by the voltage drop caused by flow of rectified grid current through a grid resistor. If desired, the bias supply may be omitted for telephony if an overload relay is incorporated in the plate circuit of the amplifier, the relay being adjusted to trip immediately when excitation is removed from the stage.

The grid resistor R_1 serves effectively as an r-f choke in the grid circuit because the impressed r-f voltage is low, and the Q of the resistor is poor. No r-f choke need be used in the grid bias return lead of the amplifier, other than those necessary for harmonic suppression.

The bias supply may be built upon the amplifier chassis if care is taken to prevent r-f from finding its way into the supply. Ample shielding and lead filtering must be employed for sufficient isolation.

The Grid Circuit As the power in the grid circuit is much lower than in the plate circuit, it is customary to use a close-spaced split-stator grid capacitor with sufficient capacitance for operation on the lowest frequency band. A physically small capacitor has a greater ratio of maximum to minimum capacitance, and it is possible to obtain a unit that will be satisfactory on all bands from 10 to 80 meters without the need for auxiliary padding capacitors. The rotor of the grid capacitor is grounded, simplifying mounting of the capacitor and providing circuit balance and electrical symmetry. Grounding the rotor also helps to retard v-h-f parasitics by by-passing them to ground in the grid circuit. The L/C ratio in the grid circuit should be fairly low, and care should be taken that circuit resonance is not reached with the grid capacitor at minimum capacitance. That is a direct invitation for instability and parasitic oscillations in the stage. The grid coil may be wound of no. 14 wire for driving powers of up to 100 watts. To restrict the field and thus aid in neutralizing, the grid coil should be physically no larger than absolutely necessary.

Circuit Layout The most important consideration in constructing a push-pull amplifier is to maintain electrical symmetry on both sides of the balanced cir-

cuit. Of utmost importance in maintaining electrical balance is the control of stray capacitance between each side of the circuit and ground.

Large masses of metal placed near one side of the grid or plate circuits can cause serious unbalance, especially at the higher frequencies, where the tank capacitance between one side of the tuned circuit and ground is often quite small in itself. Capacitive unbalance most often occurs when a plate or grid coil is located with one of its ends close to a metal panel. The solution to this difficulty is to mount the coil parallel to the panel to make the capacitance to ground equal from each end of the coil, or to place a grounded piece of metal opposite the "free" end of the coil to accomplish a capacity balance.

Whenever possible, the grid and plate coils should be mounted at right angles to each other, and should be separated far enough apart to reduce coupling between them to a minimum. Coupling between the grid and plate coils will tend to make neutralization frequency sensitive, and it will be necessary to readjust the neutralizing capacitors of the stage when changing bands.

All r-f leads should be made as short and direct as possible. The leads from the tube grids or plates should be connected directly to their respective tank capacitors, and the leads between the tank capacitors and coils should be as heavy as the wire that is used in the coils themselves. Plate and grid leads to the tubes may be made of flexible tinned braid or flat copper strip. Neutralizing leads should run directly to the tube grids and plates and should be separate from the grid and plate leads to the tank circuits. Having a portion of the plate or grid connections to their tank circuits serve as part of a neutralizing lead can often result in amplifier instability at certain operating frequencies.

Excitation Requirements In general it may be stated that the overall power requirement for grid circuit excitation to a push-pull triode amplifier is approximately 10 per cent of the amount of the power output of the stage. Tetrodes require about 1 per cent to 3 percent excitation, referred to the power output of the stage. Excessive excitation to pentodes or tetrodes will often result in reduced power output and efficiency.

Push-Pull Amplifier Construction *Symmetry* is the secret of successful amplifier design. Shown in figure 3 is the top view of a 350 watt push-pull all band

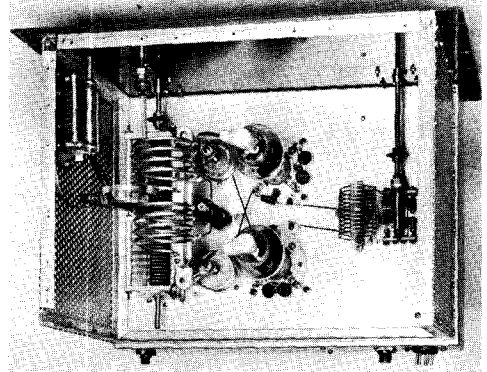

Figure 3
LAYOUT OF 350-WATT PUSH-PULL TRIODE AMPLIFIER

Two 811-A tubes are employed in this circuit. Plate tuning capacitor is at left of chassis, with swinging-link type plug-in coil assembly mounted above it. Rotor of split-stator capacitor may be insulated from ground to increase voltage breakdown rating of capacitor. Note that pickup link is series-tuned to reduce circuit reactance. One corner of rotor plate of series capacitor is bent so that capacitor shorts itself out at maximum capacitance. Grid circuit coil and capacitor are at right. Center-linked plug-in coil is employed. Parasitic chokes are placed in grid leads adjacent to the tube sockets, and tube filaments are bypassed to ground with .01 μ f. ceramic capacitors. Complete area above the chassis is enclosed with perforated screen to reduce radiation of r.f. energy.

amplifier employing 811-A tubes. The circuit corresponds to that shown in figure 2 except that the 811-A's are zero bias tubes. The bias terminals of the circuit are therefore jumpered together and no external bias supply is required at plate potentials less than 1300 volts.

All r-f components are mounted above deck. The plate circuit tuning capacitor and swinging link tank coil are to the left, with the two disc-type neutralizing capacitors between the tank circuit and the tubes. At the right of the chassis is the grid tank circuit. Small parasitic chokes may be seen between the tube sockets and the grid circuit. Plate and grid meters are placed in the under-chassis area where they are shielded from the r-f field of the amplifier.

Larger triode tubes such as the 810 and 8000 make excellent r-f amplifiers at the kilowatt level, but care must be taken in amplifier layout as the inter-electrode capacitance of these tubes is quite high. One tube and one neutralizing capacitor is placed on each side of the tank circuit (figures 4 and 5) to permit very short interconnecting leads. The relative position of the tubes and capacitors is trans-

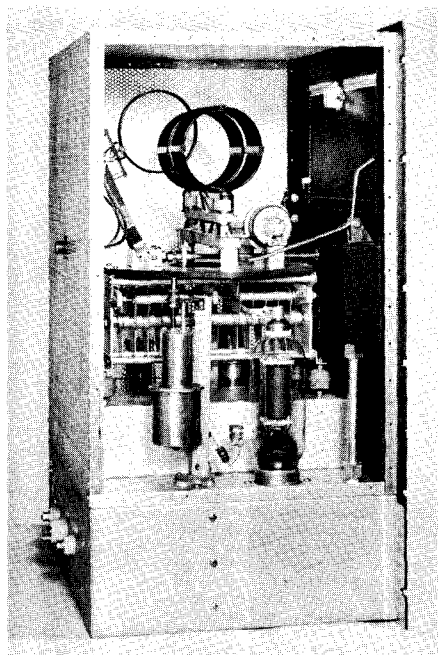

Figure 4
UNIQUE CHASSIS LAYOUT PERMITS
SHORT LEADS IN KILOWATT
AMPLIFIER

Large size components required for high level amplifier often complicate amplifier layout. In this design, the plate tank capacitor sits astride small chassis running lengthwise on main chassis. Inductor is mounted to phenolic plate atop capacitor. Variable link is panel driven through right-angle gear drive. Plate circuit is grounded by safety arm when panel door is opened. Note that plate capacitor is mounted on four TV-type capacitors which serve to bypass unit, and also act as supports. A small parasitic choke is visible next to the grid terminal of the 810 tube.

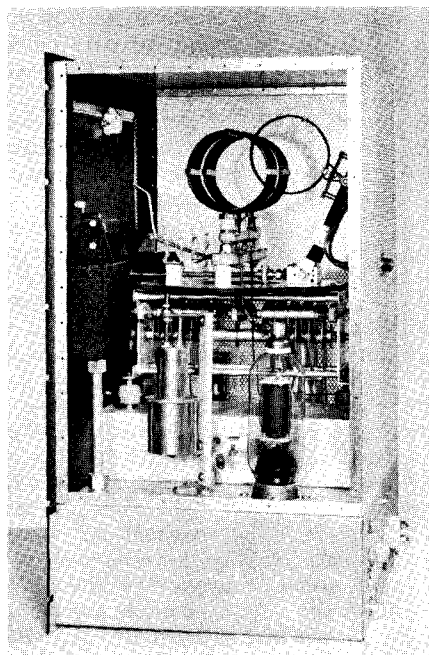

Figure 5
LEFT-HAND VIEW OF KILOWATT
AMPLIFIER OF FIGURE 4

Above shielded meter box is the protective "micro-switch" which opens the primary power circuit when the panel door is not closed. Tube sockets are recessed in the chassis so that top of tube socket shells are about 1/2-inch above chassis level. On right side of amplifier (facing it from the rear) the tube socket is nearest the panel, with the neutralizing capacitor behind it. On the opposite side, the capacitor is nearest the panel with the tube directly behind it. This layout transposition produces very short neutralizing leads, since connections may be made through the stator of plate tuning capacitor.

posed on each side of the chassis, as shown in the illustrations. The plate tank coil is mounted parallel to the front panel of the amplifier on a phenolic plate supported by the tuning capacitor which sits atop a small chassis-type box. The grid circuit tuning capacitor is located within this box, as seen in figure 6. An external bias supply is required for proper amplifier operation. Operating voltages may be determined from the instruction sheets for the particular tube to be employed.

Whenever the amplifier enclosure requires a panel door for coil changing access it is wise to place a power interlock on the door that will turn off the high voltage supply whenever the door is open!

29-3 Push-Pull Tetrode Amplifiers

Tetrode tubes may be employed in push-pull amplifiers, although the modern trend is to parallel operation of these tubes. A typical circuit for push-pull operation is shown in figure 7. The remarks concerning the filament supply, plate feed, and grid bias in Section 29-2 apply equally to tetrode stages. Because of the high circuit gain of the tetrode amplifier, extreme care must be taken to limit interstage feedback to an absolute minimum. Many amateurs have had bad luck with tetrode tubes and have been plagued with parasitics and spurious oscillations. It must be remembered with high gain tubes of this type

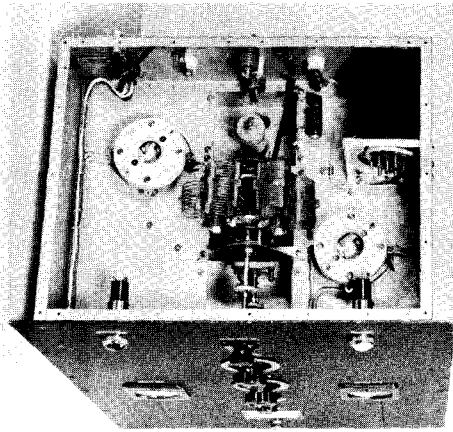

Figure 6
UNDER CHASSIS VIEW OF
1-KILOWATT TRIODE AMPLIFIER

The grid circuit tuning capacitor and plate circuit r-f choke are contained in the below chassis enclosure formed by a small chassis mounted at right angles to the front panel. The bandswitch coil assembly for the grid circuit is mounted on two brackets above this cutout. A metal screen attached to the bottom of the amplifier completes the TVI-proof enclosure.

that almost full output can be obtained with practically zero grid excitation. Any minute amount of energy fed back from the plate circuit to the grid circuit can cause instability or oscillation. *Unless suitable precautions are incorporated in the electrical and mechanical design of the amplifier, this energy feedback will inevitably occur.*

Fortunately these precautions are simple. The grid and filament circuits must be isolated from the plate circuit. This is done by placing these circuits in an "electrically tight" box. All leads departing from this box are by-passed and filtered so that no r-f energy can pass along the leads into the box. This restricts the energy leakage path between the plate and grid circuits to the residual plate-to-grid capacity of the tetrode tubes. This capacity is of the order of 0.25 $\mu\text{mfd.}$ per tube, and under normal conditions is sufficient to produce a highly regenerative condition in the amplifier. Whether or not the amplifier will actually break into oscillation is dependent upon circuit losses and residual lead inductance of the stage. Suffice to say that unless the tubes are actually neutralized a condition exists that will lead to circuit instability and oscillation under certain operating conditions. With luck, and a

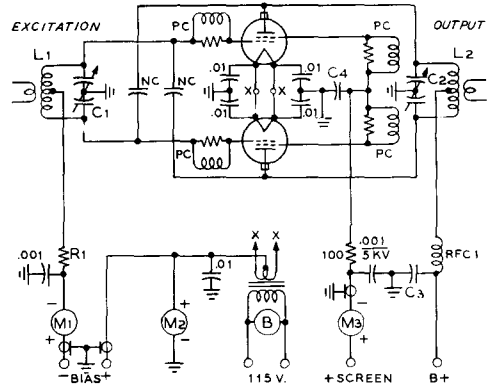

Figure 7
CONVENTIONAL PUSH-PULL
TETRODE AMPLIFIER CIRCUIT

Push-pull amplifier uses many of the same components required by triode tubes (see figure 2). Screen supply is also required. B—Blower for filament seals of tubes.

C₁—Low internal inductance capacitor, .001 $\mu\text{fd.}$, 5KV. Centralab type 8585 - 1000.

NC—See text and figure 8.

PC—Parasitic choke. 50 ohm, 2-watt composition resistor wound with 3 turns #12 e. wire.

Note: Strap multiple screen terminals together at socket with $\frac{3}{8}$ " copper ribbon. Attach PC to center of strap.

heavily loaded plate circuit, one might be able to use an un-neutralized push-pull tetrode amplifier stage and suffer no ill effects from the residual grid-plate feedback of the tubes. In fact, a minute amount of external feedback in the power leads to the amplifier may just (by chance) cancel out the inherent feedback of the amplifier circuit. Such a condition, however, results in an amplifier that is not "reproducible." There is no guarantee that a duplicate amplifier will perform in the same, stable manner. This is the one, great reason that many amateurs having built a tetrode amplifier that "looks just like the one in the book" find out to their sorrow that it does not "work like the one in the book."

This borderline situation can easily be overcome by the simple process of neutralizing the high-gain tetrode tubes. Once this is done, and the amplifier is tested for parasitic oscillations (and the oscillations eliminated if they occur) the tetrode amplifier will perform in an excellent manner on all bands. In a word, it will be "reproducible."

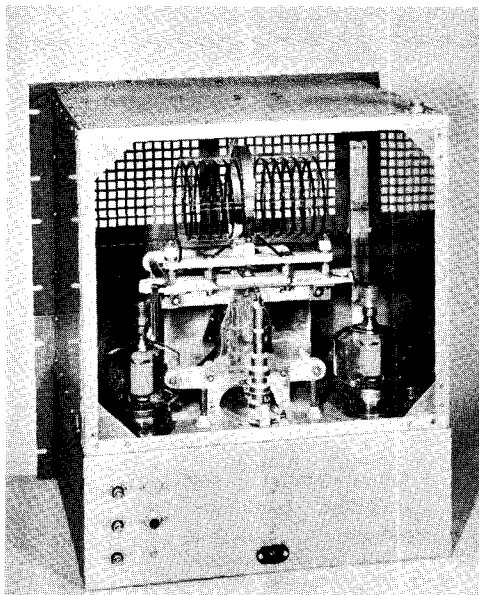

Figure 8
REAR VIEW OF PUSH PULL
4-250A AMPLIFIER

The neutralizing rods are mounted on ceramic feedthrough insulators adjacent to each tube socket. Low voltage power leads leave the grid circuit compartment via Hypass capacitors located on the lower left corner of the chassis. A screen plate covers the rear of the amplifier during operation. This plate was removed for the photograph.

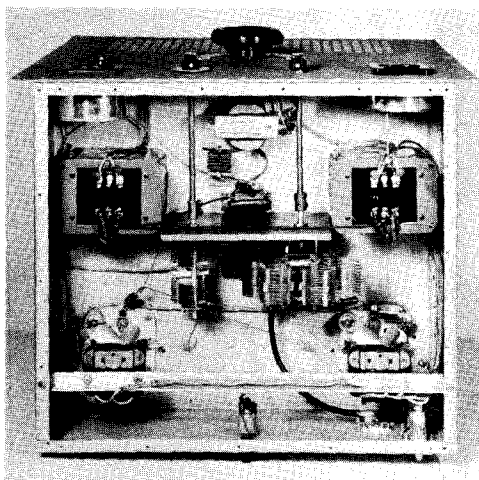

Figure 9
UNDER CHASSIS VIEW OF
4-250A AMPLIFIER

The bias supply for the amplifier is mounted at the front of the chassis between the two control shafts. A blower motor is mounted beneath each tube socket. A screened plate is placed on the bottom of the chassis to complete the under-chassis shielding.

As a summation, three requirements must be met for proper operation of tetrode tubes—whether in a push-pull or parallel mode:

1. Complete isolation must be achieved between the grid and plate circuits.
2. The tubes must be neutralized.
3. The circuit must be parasitic-free.

Amplifier Construction The push-pull tetrode amplifier should be built around two "r-f tight" boxes for the grid and plate circuits. A typical layout that has proven very satisfactory is shown in figures 8 and 9. The amplifier is designed around a *Barker & Williamson* "butterfly" tuning capacitor. The 4-250A tetrode tubes are mounted at the rear of the chassis on each side of the capacitor. The base shells of the tubes are grounded by spring clips, and short adjustable rods project up beside each tube to act as neutralizing capacitors. The leads to these rods are cross-connected beneath the chassis and the rods provide a small value of capacitance to the plates of the tubes. This neutralization is necessary when the tube is operated with high

power gain and high screen voltage. As the operating frequency of the tube is increased, the inductance of the internal screen support lead of the tube becomes an important part of the screen ground return circuit. At some critical frequency (about 45 Mc. for the 4-250A tube) the screen lead inductance causes a series resonant condition and the tube is said to be "self-neutralized" at this frequency. Above this frequency the screen of the tetrode tube cannot be held at ground potential by the usual screen by-pass capacitors. With normal circuitry, the tetrode tube will have a tendency to self-oscillate somewhere in the 120 Mc. to 160 Mc. region. Low capacity tetrodes that can operate efficiently at such a high frequency are capable of generating robust parasitic oscillations in this region while the operator is vainly trying to get them operating at some lower frequency. The solution is to introduce enough loss in the circuit at the frequency of the parasitic so as to render oscillation impossible. This procedure has been followed in this amplifier.

During a long series of experiments designed to stabilize large tetrode tubes, it was found that suppression circuits were most effective when inserted in the *screen lead* of the

tetrode. The screen, it seemed, would have r-f potentials measuring into the thousands of volts upon it during a period of parasitic oscillation. By-passing the screen to ground with copper strap connections and multiple by-pass capacitors did little to decrease the amplitude of the oscillation. Excellent parasitic suppression was brought about by strapping the screen leads of the 4-250A socket together (figure 7) and inserting a parasitic choke between the screen terminal of the socket and the screen by-pass capacitor.

After this was done, a very minor tendency towards self-oscillation was noted at extremely high plate voltages. A small parasitic choke in each grid lead of the 4-250A tubes eliminated this completely.

The neutralizing rods are mounted upon two feedthrough insulators and cross-connected to the 4-250A control grids beneath the chassis. These rods are threaded so that they may be run up and down the insulator bolt for neutralizing adjustment.

Because of the compact size of many tetrodes it is necessary to cool the filament seals of the tube with a blast of air. A small blower can be mounted beneath the chassis to project cooling air directly at the socket of the tube as shown in figure 9.

Inductive Tuning of Push-Pull Amplifiers The plate tank circuit of the push-pull amplifier must have a low

impedance to ground at harmonic frequencies to provide adequate harmonic suppression. The usual split-stator tank capacitor, however, has an uncommonly high impedance in the VHF region wherein the interference-causing harmonics lie. A push-pull vacuum-type capacitor may be used as these units have very low internal inductance, but the cost of such a capacitor is quite high.

A novel solution to this problem is to employ a split stator capacitor made up of two inexpensive *fixed* vacuum capacitors. Amplifier adjustment can then best be accomplished by inductive tuning of the plate tank coil as

seen in figure 10. Two fixed vacuum capacitors are mounted vertically upon the chassis and the upper terminals are attached to the plates of the amplifier tubes by means of low impedance straps. Resonance is established by rotation of a shorted copper loop located within the amplifier tank coil. This loop is made of a $\frac{3}{8}$ " long section of copper water pipe, two inches in diameter. Approximate resonance is established by varying the spacing between the turns of the copper tubing tank coil. Inductive coupling is used between the tank coil and the antenna circuit in the usual manner. Sufficient range to enable the operator to cover a complete high frequency band may be had with this interesting tuning method.

29-4 Tetrode Pi-Network Amplifiers

The most popular amplifier today for both commercial and amateur use is the pi-network configuration shown in figure 11. This circuit is especially suited to tetrode tubes, although triode tubes may be used under certain circumstances.

A common form of pi-network amplifier is shown in figure 11A. The *pi* circuit forms the matching system between the plate of the amplifier tube and the low impedance, unbalanced antenna circuit. The coil and input capacitor

Figure 10
INDUCTIVE TUNING MAY BE EMPLOYED IN HIGH POWER AMPLIFIER

Two fixed vacuum capacitors form split-stator capacitance, providing very low inductance ground path for plate circuit harmonics. Tuning is accomplished by means of shorted, single-turn link placed in center of tank coil. Shorted link is made from $\frac{3}{8}$ -inch section cut from copper water pipe. Larger link outside of tank coil is antenna pick-up coil.

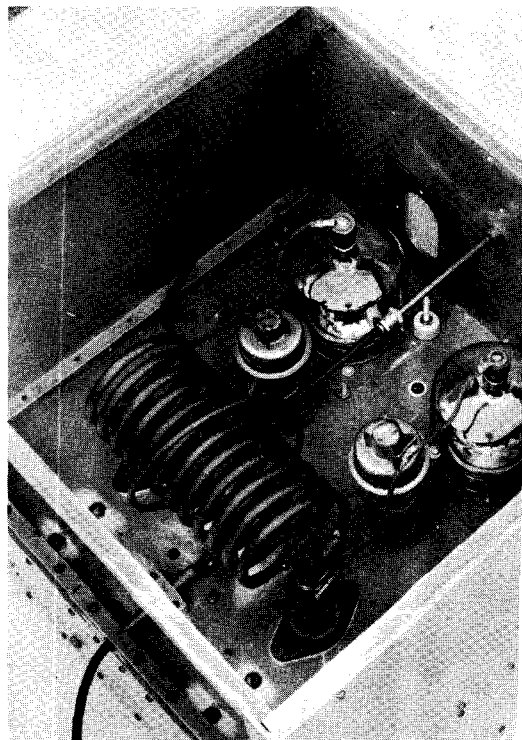

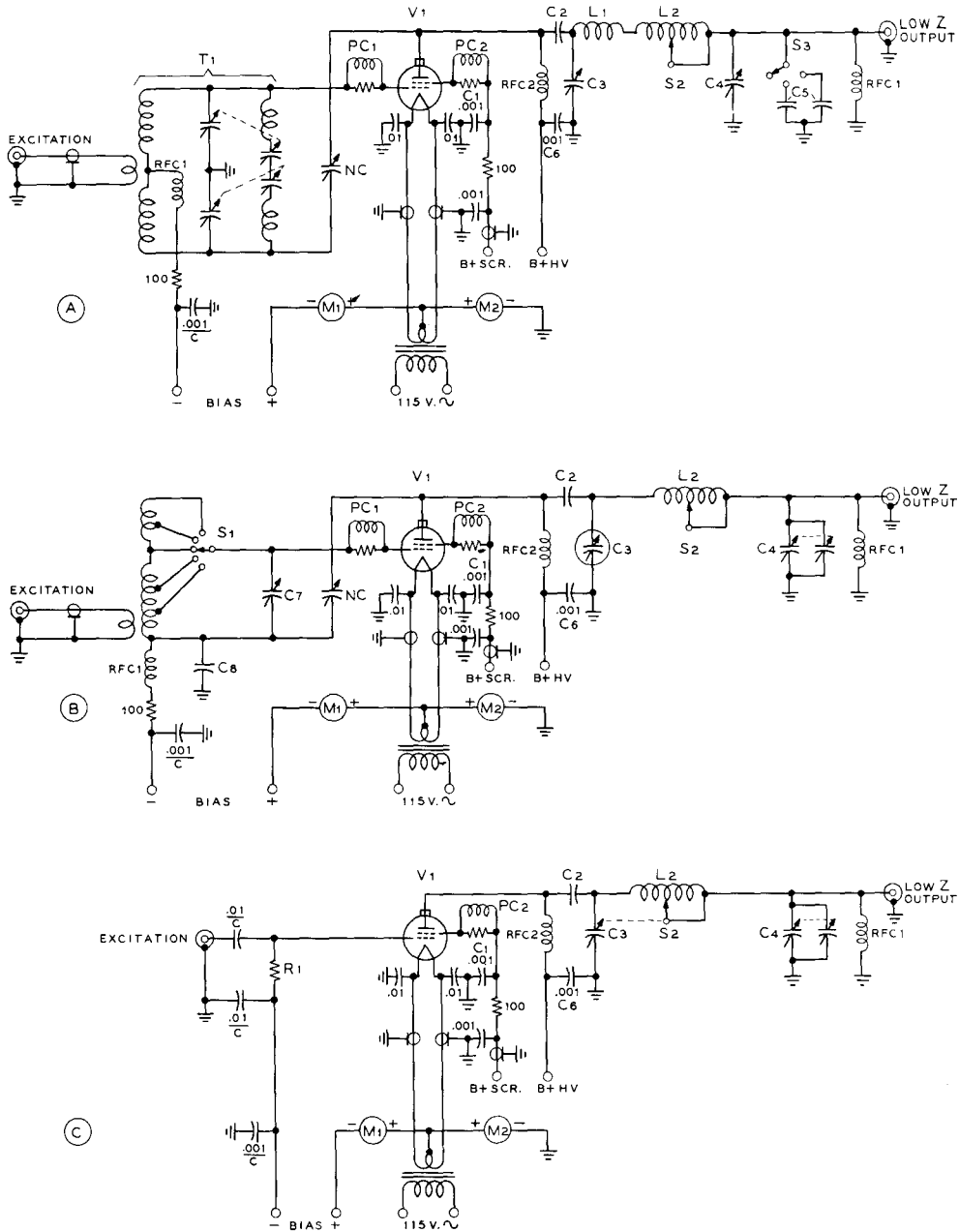

Figure 11

TYPICAL PI-NETWORK CONFIGURATIONS

A—Split grid circuit provides out-of-phase voltage for grid neutralization of tetrode tube. Rotary coil is employed in plate circuit, with small, fixed auxiliary coil for 28 Mc. Multiple tuning grid tank T₁ covers 3.5 - 30 Mc. without switching.

B—Tapped grid and plate inductors are used with "bridge type" neutralizing circuit for tetrode amplifier stage. Vacuum tuning capacitor is used in input section of pi-network.

C—Untuned input circuit (resistance loaded) and plate inductor ganged with tuning capacitor comprise simple amplifier configuration.

PC₁, PC₂—57 ohm, 2 watt composition resistor, wound with 3 turns #18 c. wire.

of the pi may be varied to tune the circuit over a 10 to 1 frequency range (usually 3.0 - 30 Mc.). Operation over the 20 - 30 Mc. range takes place when the variable slider on coil L_2 is adjusted to short this coil out of the circuit. Coil L_1 therefore comprises the tank inductance for the highest portion of the operating range. This coil has no taps or sliders and is constructed for the highest possible Q at the high frequency end of the range. The adjustable coil (because of the variable tap and physical construction) usually has a lower Q than that of the fixed coil.

The degree of loading is controlled by capacitors C_1 and C_2 . The amount of circuit capacity required at this point is inversely proportional to the operating frequency and to the impedance of the antenna circuit. A loading capacitor range of 100 $\mu\text{fd.}$ to 2500 $\mu\text{fd.}$ is normally ample to cover the 3.5 - 30 Mc. range.

The pi circuit is usually shunt-fed to remove the d.c. plate voltage from the coils and capacitors. The components are held at ground potential by completing the circuit ground through the choke RFC. Great stress is placed upon the plate circuit choke RFC. This component must be specially designed for this mode of operation, having low inter-turn capacity and no spurious internal resonances throughout the operating range of the amplifier.

Parasitic suppression is accomplished by means of chokes PC-1 and PC-2 in the screen and grid leads of the tetrode. Suitable values for these chokes are given in the parts list of figure 11. Effective parasitic suppression is dependent to a large degree upon the choice of screen bypass capacitor C_3 . This component must have extremely low inductance throughout the operating range of the amplifier and well up into the VHF parasitic range. The capacitor must have a voltage rating equal to at least twice the screen potential (four times the screen potential for plate modulation). There are practically no capacitors available that will perform this difficult task. One satisfactory solution is to allow the amplifier chassis to form one plate of the screen capacitor. A "sandwich" is built upon the chassis with a sheet of insulating material of high dielectric constant and a matching metal sheet which forms the screen side of the capacitance. A capacitor of this type has very low internal inductance but is very bulky and takes up valuable space beneath the chassis. One suitable capacitor for this position is the *Centralab type 858S-1000*,

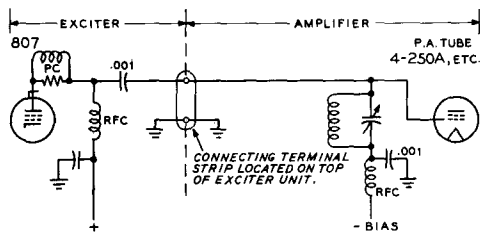

Figure 12
CAPACITIVE COUPLING CIRCUIT
BETWEEN EXCITER AND FINAL
AMPLIFIER STAGE MAKES USE
OF ONE COMMON TANK CIRCUIT
Grid circuit of amplifier stage serves as plate circuit of exciter in this simplified circuit. Leads between the tubes must be kept short and direct.

rated at 1000 $\mu\text{fd.}$ at 5000 volts. This compact ceramic capacitor has relatively low internal inductance and may be mounted to the chassis by a 6-32 bolt. It is shown in various amplifiers described in this chapter. Further screen isolation may be provided by a shielded power lead, isolated from the screen by a .001 $\mu\text{fd.}$ ceramic capacitor and a 100 ohm carbon resistor.

Various forms of the basic pi-network amplifier are shown in figure 11. The *A* configuration employs the so-called "all-band" grid tank circuit and a rotary pi-network coil in the plate circuit. The *B* circuit uses coil switching in the grid circuit, bridge neutralization, and a tapped pi-network coil with a vacuum tuning capacitor. Figure 11C shows an interesting circuit that is becoming more popular for class AB1 linear operation. A tetrode tube operating under class AB1 conditions draws no grid current and requires no grid driving power. Only r-f voltage is required for proper operation. It is possible therefore to dispense with the usual tuned grid circuit and neutralizing capacitor and in their place employ a simple load resistor in the grid circuit across which the required excitation voltage may be developed. This resistor can be of the order of 50 - 300 ohms, depending upon circuit requirements. Considerable power must be dissipated in the resistor to develop sufficient grid swing, but driving power is often cheaper to obtain than the cost of the usual grid circuit components. In addition, the low impedance grid return removes the tendency towards instability that is so common to the circuits of figure 11A and 11B. Neutralization is not required of the circuit of figure 11C, and in many cases parasitic suppression may be omitted. The price that must be paid is the



Figure 13
MIDGET LINEAR AMPLIFIER FOR
MOBILE SIDEBAND OPERATION
FEATURES WATER COOLED
4W-300B TETRODE TUBES

Miniature amplifier is comparable in size with sideband exciter. Antenna, plate, and screen current are monitored by panel lamps used in place of larger and more expensive meters. Inductor slug of grid coil is located below plate circuit tuning capacitor.

additional excitation that is required to develop operating voltage across grid resistor R_1 .

The pi-network circuit of figure 11C is interesting in that the rotary coil L_2 and the plate tuning capacitor C_3 are ganged together by a gear train, enabling the circuit to be tuned to resonance with one panel control instead of the two required by the circuit of figure 11A. Careful design of the rotary inductor will permit the elimination of the auxiliary high frequency coil L_1 , reducing the cost and complexity of the circuit.

A single tuned circuit may be employed to couple the power amplifier grid circuit to the buffer stage as shown in figure 12. Care must be taken to ensure that a good ground exists between the two circuits.

29-5 A Compact Linear Amplifier for Mobile SSB

Single sideband transmission is ideal for mobile operation because it provides the maximum amount of "talk power" for a given amount of primary power drain. The new three phase alternator systems available for automotive use are capable of supplying over one thousand watts of primary power, making the proposition of a kilowatt sideband transmitter a reality.

The compact kilowatt linear amplifier described in this section is designed for remote control operation on any one amateur band. It may be driven by any exciter capable of one or two watts p.e.p. output.

Amplifier Circuit The circuit of the mobile linear amplifier is shown in figure 14.

Designed around two *Eimac* 4W-300B water cooled tetrode tubes, the amplifier may nevertheless be used with 4X-250B or 4CX-300A tubes if air cooling is employed. For purely mobile operation the water cooled tubes are recommended as air blowers are bulky, noisy, and draw a high current from the automobile primary power system. Water cooling, although unfamiliar to many amateurs, is relatively simple and inexpensive. A *Stewart-Warner* fuel pump is used to pump distilled water from a reservoir through polyethylene tubes to the anodes of the 4W-300B tetrode and back through other tubes to the reservoir. This container is a surplus one gallon G.I. gasoline can (figure 17). The temperature of the water remains under 100°F . even when the transmitter is operated for extended periods of time. The water jackets of the tubes are connected in series as shown in the drawing. It has been found by experiment that it is not necessary to have any other form of cooling medium to maintain the tubes at a safe temperature. The water pump draws a current of 0.2 amperes at maximum pumping speed. It is mounted in a corner of the turtle-back of the automobile, along with the G.I. water can. The pump motor is connected so that it starts as soon as filament voltage is applied to the two 4W-300B tubes.

The two tetrode tubes are connected in parallel with a parallel resonant plate circuit and a simple "pi-type" grid circuit. The plate circuit consists of a miniature *Jennings* *GSLA-120* variable vacuum capacitor (C_1) in parallel with a silver plated copper tubing tank coil. Plate voltage is fed to the tubes through a r-f choke and the anodes of the tubes are coupled to the tank circuit through a $500\ \mu\text{fd.}$, 5 KV ceramic capacitor. The low impedance antenna system is directly tapped at a low impedance point on the tank coil. A small 6 volt automobile headlamp is placed in series with the antenna lead to provide a simple indicator of r-f current. Antenna transfer is accomplished by means of a miniature *Jennings* *RB-1* s.p.d.t. vacuum relay.

Special low impedance sockets for these tubes are supplied by the *Eimac* Co. and their use is recommended. The sockets have a built-

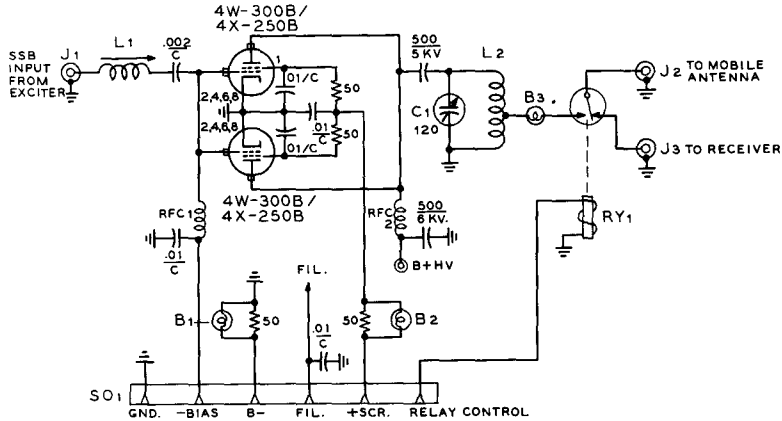

Figure 14
SCHEMATIC, MOBILE LINEAR AMPLIFIER

- C₁**—120 μ fd., 5KV variable vacuum capacitor. Jennings G5LA-120
- L₁**—(20 meters): 15 turns #18e., $\frac{5}{8}$ " diam., 1" long. Adjust to resonance with J₁ shorted and tubes in sockets.
- L₂**—(20 meters); 6 turns, $\frac{1}{4}$ -inch silver plated copper tubing, $2\frac{1}{2}$ " i.d., 2" long. Adjust antenna tap for proper loading.
- RFC₁**—2.5 mh. National R-100
- RFC₂**—225 turns #28 manganin, $\frac{5}{8}$ " dia., 2" long, in series with National R-100 choke. Or, heavy-duty Raypar RL-102 choke may be substituted for these two items.
- RY₁**—SPDT relay, d.c. coil to match battery voltage. Jennings RB-1 vacuum relay employed
- B₁, B₂, B₃**—Indicator pilot lamps. B₁ should have 500 ma. rating; B₂, 60 ma. rating; and B₃ may be automobile headlight lamp heavy enough to carry antenna current.

in screen capacitor which provides an extremely low impedance screen ground return circuit, reducing the problem of parasitics to a minimum.

A simple "series" tuned input circuit is employed in the grid circuit. The internal input capacitance of the tubes is effectively in parallel with the grid coil resonating it to the operating frequency. Since no grid current is drawn during class AB1 operation a small battery may be used to provide the correct value of operating bias. Flashlight bulbs are placed in the screen and negative high voltage leads instead of meters to conserve space.

Amplifier Construction Class AB1 operation plus the complete absence of parasitics results in a very minimum amount of harmonic generation. The use of a low inductance variable vacuum capacitor provides an effective return path to ground for high frequency harmonics appearing in the

Figure 15
SMALL SIZE OF LINEAR AMPLIFIER IS DUE TO USE OF MINIATURE 300 WATT, WATER COOLED TETRODE TUBES

Parallel operation of the 4W-300B tubes is employed. Plate tank inductor is at right, with miniature variable vacuum capacitor behind it. Plate choke is in the foreground, made up of a 2.5 mh. choke in series with a home-made unit. Commercial choke may be used, as indicated in parts list of figure 14. Special low inductance Eimac sockets are employed with the tubes. Vacuum-type antenna relay is at top, center.

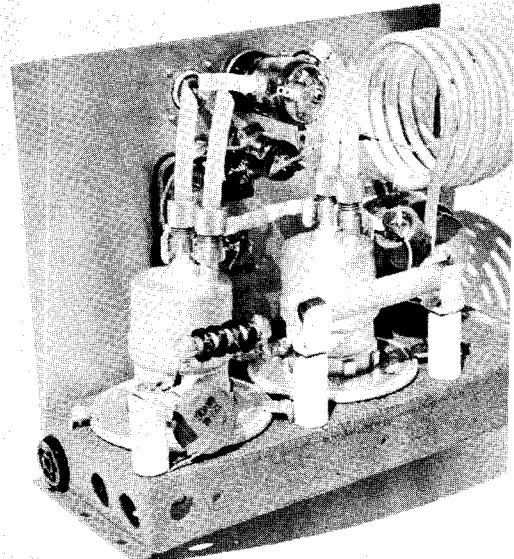

plate circuit of the amplifier. As a result, a very minimum of shielding and lead filtering is required with this amplifier even when 28 Mc. operation is desired. Placing the amplifier within the turtle-back of the automobile and the insertion of a low pass TV-filter in the coaxial antenna line reduces TVI-producing harmonics to such a low value that no interference is caused to a nearby television receiver tuned to a channel 2 signal of moderate strength.

The amplifier is built upon a shallow metal deck just large enough to hold the various components (figure 15). The two 4W-300B tube sockets are placed in the left area of the chassis with the variable vacuum capacitor mounted at the right corner of the front panel. The silver plated copper tubing tank coil is bolted between the rear terminal of the capacitor and one of the capacitor mounting bolts. Make sure that a good connection exists between the capacitor, the panel, and the chassis as this ground return is part of the plate tank circuit.

Centered on the front panel are the three pilot lamp indicator sockets, the antenna changeover relay and the coaxial antenna receptacles. At the rear of the chassis is the plate r-f choke. Two r-f chokes in series were used in the original model, but have since been replaced with one of the new *Raypar* miniature chokes (see parts list, figure 14).

The grid circuit components are mounted in the under-chassis area of the amplifier (figure 16). A shield plate is placed over the bottom of the amplifier to completely isolate the components from the field of the plate tank circuit. Grid coil L₁ is mounted to the panel and slug-tuned to resonance. The grid terminals of the tube sockets are connected with a short length of 1/4-inch wide copper

strap. A wire interconnecting lead will invariably lead to VHF parasitic oscillation of the stage.

Amplifier Operation The amplifier must be completely tested before it is installed in the automobile. Grid, plate, and screen meters should be inserted in the power leads to the amplifier and preliminary tune-up into a dummy load is done at reduced screen and plate potentials. A small driving signal is applied to the amplifier and grid coil L₁ resonated. The screen and plate currents will increase sharply in value when the grid circuit is tuned to the operating frequency. The degree of plate loading is determined by the position of the antenna tap on the plate tank coil.

Screen current is a very sensitive indicator of the degree of amplifier antenna loading. At plate potentials of 2000 or so the total screen current at one kilowatt peak input is about 10 milliamperes, varying slightly with individual tubes. As the plate potential is raised above this value the screen current gradually drops until at 3000 volts plate potential the screen current is near zero. In general, overcoupling of the amplifier will be indicated by low screen current and undercoupling will result in high values of screen current. At 3000 volts plate potential, an overcoupled condition is indicated by *negative* screen current, and undercoupling will produce positive screen current. Only a slight deviation from zero current during voice operation indicates proper operation. Maximum *peak* input under these conditions is about 1500 watts (3000 volts at 500 ma.).

The Power Supply This amplifier is designed to work from a three-phase alternator system of 1500 watts capacity. A three-phase rectifier supply is employed to

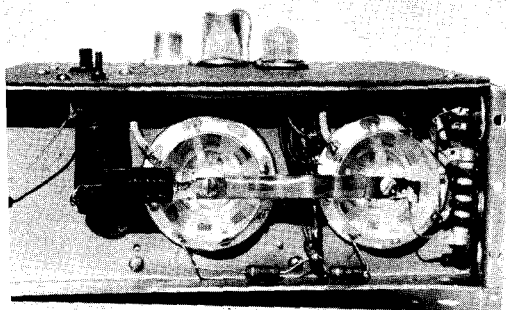

Figure 16
UNDER-CHASSIS VIEW OF MOBILE
SSB LINEAR AMPLIFIER SHOWS
SIMPLICITY OF CIRCUIT

Input circuit is at the left, with grid terminals of socket connected with short copper strap. Screen series resistors are at center, with grid choke and power plug at right. Under-chassis area is enclosed with aluminum bottom plate held in place with self-tapping sheet metal screws.

provide 2500 volts at 400 milliamperes (figure 18). Since the frequency of the alternator is 120 cycles or higher and the ripple output of the supply is less than 5% before filtering, a small capacitor is sufficient to produce pure d.c. and to provide good regulation for peak power surges.

In the interest of power conservation and compactness the new *Sarkes-Tarzian* silicon rectifiers are used in the high and low voltage power supplies. These rectifiers can be operated in series with no special selection. It is possible therefore to provide compact and inexpensive high voltage rectifiers by connecting a number of the standard type *M-500* rectifiers in series to obtain the required peak inverse voltage rating. The higher cost of the bank of silicon rectifiers as compared to vacuum tube rectifiers is offset by the elimination of the tubes and a special three-phase filament transformer. If desired, the special *Sarkes-Tarzian 280-SM* rectifier stack may be substituted for the individual units. Since the

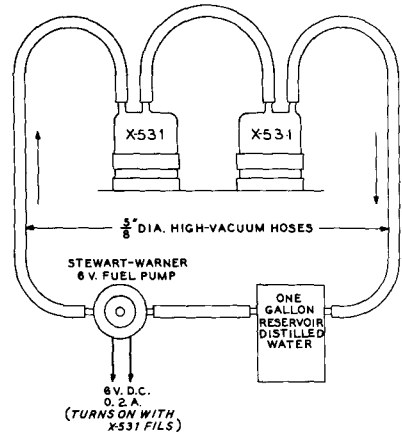

Figure 17
WATER CIRCULATION SYSTEM
FOR X-531 (4W-300B) TUBES

alternator will not supply much more than 1500 watts, the primary voltage drops rapidly

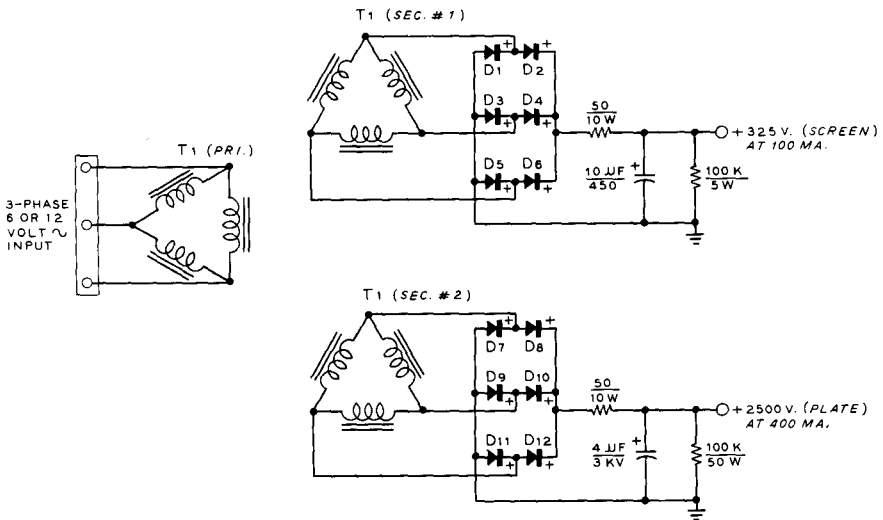

Figure 18
SCHEMATIC, THREE-PHASE MOBILE POWER SUPPLY

- D₁-D₆:—500 ma. silicon rectifier. *Sarkes-Tarzian M-500*
- D₇-D₁₂:—2.5 KV, 130 ma. rectifier stack. *Sarkes-Tarzian 280-SM* silicon rectifier. See text for substitute
- T₁:—Special three-phase power transformer to deliver 2500 volts d.c. at 400 ma., and 325 volts d.c. at 100 ma. Design data and core may be obtained from *Arnold Engineering Co., Marengo, Ill.* Core number: *ATA-1573* with 12-mil *Hypersil* laminations for 120 cycle operation.
- Primary winding: (12 volts)—Each leg, 15 turns #8e. wire
(6 volts)—Each leg, 7 turns #5e. wire
- Low Voltage secondary, Each leg, 265 turns #30e. wire
- High Voltage secondary: Each leg, 2400 turns #28e. wire
- 7.5 KV insulation employed. High voltage winding placed next to core, low voltage secondary next, and primary winding outside, with 2KV insulation. Vacuum impregnate windings. When finished, polarize windings by placing 6 volt, 50 c.p. lamps in series with each primary lead. Bulbs should only glow red when primary windings are correctly polarized. Correct polarization of secondary windings will deliver desired output voltages.

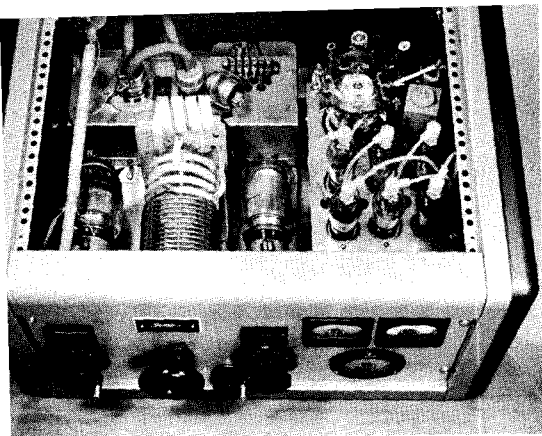

Figure 19
WATER COOLED LINEAR
AMPLIFIER PACKAGED FOR
FIXED STATION USE

Either 4W-300B (water cooled) tubes or 4X-250B (air cooled) tubes may be employed in this compact linear amplifier. Input and output capacitors of pi-network are vacuum units, and power supply (three phase) is contained within the cabinet (right). Wide band plate r.f. choke is at left of cabinet, running from front to back. Amplifier operates at plate potential of 3000 volts, with p.e.p. of 1500 watts.

under overload conditions and the silicon rectifiers cannot be damaged, even with a direct short circuit across the output terminals of the high voltage power supply.

This unusual equipment is described for others who may wish to make models based upon ideas presented in the design. Although some of the components shown in the amplifier or power package are unique or are not readily available, it is hoped that the reader can make use of his facilities and abilities to use many of the ideas shown herewith.

Variations Upon the Basic Circuit

It is possible to increase the power level of this amplifier by merely adding more tubes connected in parallel with the original two. Three tubes will permit a p.e.p. of two kilowatts at 3000 volts plate potential.

Four tubes in parallel will provide a p.e.p. of two kilowatts at 2000 volts plate potential. An experimental amplifier having five tubes in parallel has run 3500 watts p.e.p. into dummy loads. The five tube amplifier employed neutralization and parasitic suppression and performed in normal fashion with no signs of instability.

Shown in figure 19 is a fixed station version of this amplifier. Employing a pi-section plate tank circuit and a three-phase power supply, the complete unit is built within a standard 12" x 16" x 19" cabinet. Of unusual interest is the r-f choke employed in the plate circuit of the linear amplifier stage. This choke is usually a critical item as the full value of r-f plate potential is developed across it. For maximum amplifier efficiency and minimum loss the plate choke must present an impedance of several thousand ohms at any frequency of operation. Special r-f chokes are available that will perform this exacting task, and the one described equals the best of the commercial items at a fraction of the cost. The choke coil consists of 250 turns of #22 double cotton covered *manganin* wire close-wound upon a 1/2-inch diameter wooden dowel rod. The small d.c. resistance of the winding effectively destroys undesired resonance effects within the choke, providing a high and uniform impedance across all amateur bands from 80- to 10-meters. The choke will work well up to power levels of the order of 2000 watts, p.e.p., or 1000 watts, plate modulated.

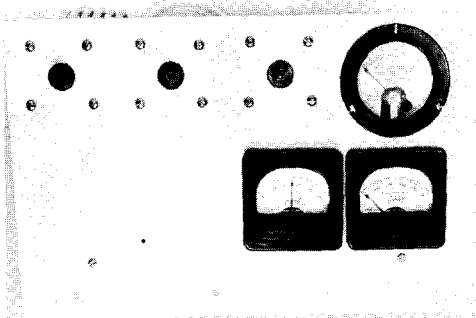

Figure 20
MULTI-BAND LINEAR AMPLIFIER
FOR MOBILE SERVICE FEATURES
THREE SEPARATE TANK CIRCUITS
SWITCHED BY CONTROL RELAYS

Three vacuum tank capacitors are located at top left corner of panel. To the right is thermocouple r.f. ammeter in output circuit. Zero-center screen meter and 0-500 d.c. ma. plate meter are at lower right.

29-6 A Multi-band Mobile Linear Amplifier

The kilowatt linear amplifier described in this section is designed for remote control mobile operation on any three amateur bands. The unit shown in the photographs operates on the 80, 40, and 20 meter bands, but operation on 15 or 10 meters is possible by altering the constants of the plate tank circuit.

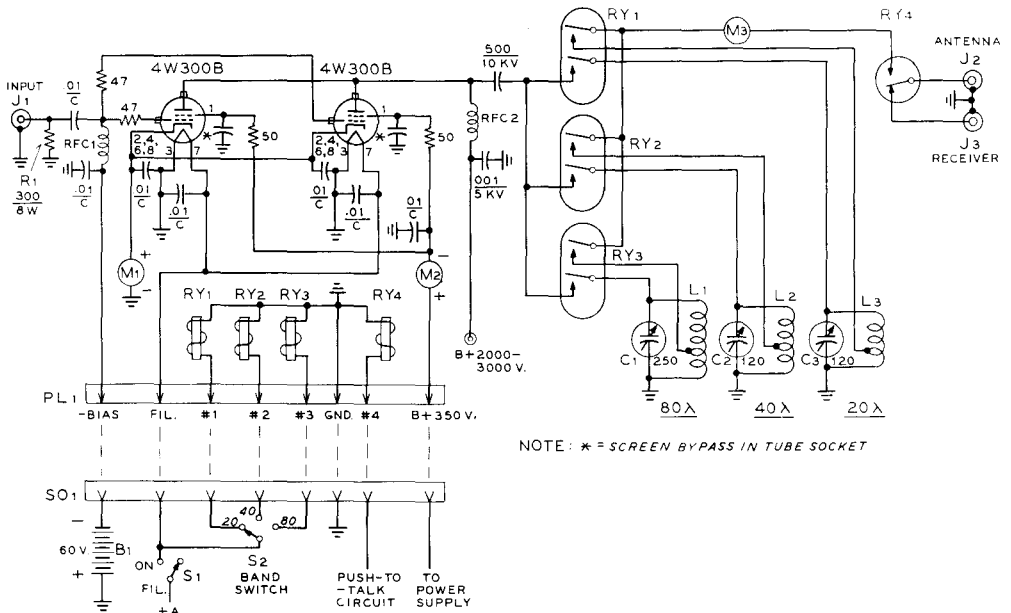

Figure 21
SCHEMATIC, MULTI-BAND MOBILE LINEAR AMPLIFIER

- C₁, C₂, C₃**—Jennings variable vacuum capacitor, type GSLA. Use 250 μ fd. unit for 80 meters and 120 μ fd. units for other bands. Adjust coils to resonate circuit with capacitors set near maximum value.
- L₁**—16 turns, $\frac{1}{4}$ -inch silver plated copper tubing, $2\frac{1}{2}$ " i.d., $3\frac{1}{2}$ " long. Antenna tap approximately 2 turns from ground end.
- L₂**—8 turns, same as L₁. Antenna tap approximately 2 turns from ground end.
- L₃**— $5\frac{1}{2}$ turns, same as L₁. Antenna tap approximately $\frac{3}{4}$ turn from ground end.
- RFC₁**—Wide band choke, 500 ma. rating. Raypar RL-102
- RY_{1, 2, 3}**—DPDT relay, d.c. coil to match battery voltage. Jennings type RB vacuum relay
- RY₄**—SPST relay, d.c. coil to match battery voltage. Jennings type RB-1 vacuum relay (Jennings Radio Co., San Jose, Calif.)
- M₁**—0 - 500 ma. d.c. meter
- M₂**—500 - 0 - 500 d.c. micro-ammeter, zero center movement, shunted to 50 - 0 - 50 ma.
- M₃**—0 - 5 ampere, r.f. ammeter

Amplifier Circuit The amplifier employs two external anode tetrodes such as the 4W-300B, 4X-250B, or 4CX-300A. The water cooled tubes are recommended for mobile operation, while the air cooled tubes may be used for fixed operation. The schematic of the amplifier is shown in figure 21 and is a version of the untuned input circuit of figure 11C.

Three separate parallel tuned plate circuits are employed in the linear amplifier. Each circuit is made up of a silver plated copper tubing coil paralleled with a miniature variable vacuum tuning capacitor. These new Jennings capacitors are extremely small in size and are tuned by means of a slotted shaft instead of the more cumbersome and expensive counter dial arrangement. The low impedance mobile antenna system is tapped directly on experimentally determined points on the tank

coils. The proper tuned circuit is switched to the linear amplifier by means of miniature vacuum-sealed d.p.d.t. relays. Three relays are required, one for each tank circuit. The tank circuits are relatively low impedance devices as they are tuned with capacitors having a large value of maximum capacitance, permitting good efficiency in matching the tubes to the very low load impedance presented by the mobile antenna system.

Although the tubes operate with "zero" driving power the resistive input system demands that approximately 9 watts of excitation be employed to develop 50 volts (peak) across the 300 ohm circuit impedance. The mobile SSB exciters of Chapter 28 used in conjunction with a 2E26 linear buffer stage will supply an abundance of excitation for this kilowatt amplifier. Alternatively, a high impedance grid circuit such as shown in figure

11B may be used, dropping the grid driving power level to a watt or so.

Selection of the proper tank circuit is accomplished by means of a rotary switch (S_2) located at the driver's position in the automobile. One of the three miniature plate circuit relays at a time may be operated by this switch. The antenna change-over relay is actuated by the push-to-talk circuit in the microphone.

Amplifier Construction The amplifier is built upon a shallow metal deck (figure 22). The two *Eimac* low inductance sockets for the tetrode tubes are placed in the rear corner of the chassis with the 80 meter tank coil to their left. One end of the coil is bolted to the chassis and the other end is attached to the rear terminal of the variable vacuum capacitor which is mounted to the metal panel. The 40 and 20 meter tank coils are mounted directly to their respective tuning capacitors.

The front area of the chassis is taken up with the plate circuit switching relays RY₁₋₂₋₃. These relays are bolted to the chassis and connections are made to the various terminals by means of flexible 1/4-inch silver plated copper strap. The three meters are mounted in the remaining panel space. Under-chassis wiring is extremely simple, as seen in figure 23. The socket grid terminals are connected together with a short length of copper strap. A shield is not required over the bottom of the chassis since the grid circuit is untuned.

Amplifier Operation The amplifier should be bench-tested before it is placed within the automobile. Operating conditions are similar to those described in Section 29-5. A center-reading milliammeter is used in the screen circuit to observe screen current during loading adjustments. Linear operation may be checked with the aid of envelope detectors, as discussed in an earlier chapter. Normal operation takes place at 2500 volts at 400 milliamperes, peak current. Screen current is less than 5 milliamperes under these conditions. Grid current is zero.

29-7 An Inexpensive Cathode Driven Kilowatt Amplifier

An objectionable feature of triode tubes is that they must be neutralized in conventional grid driven circuits. Tetrode tubes may often dispense with the neutralizing circuit, but they require a screen power supply whose cost and complexity dissipate the saving afforded by the elimination of the neutralizing circuit. The use of a *cathode driven amplifier* employing zero bias tubes overcomes these two disadvantages. The grids act as an excellent screen between the plate and cathode so neutralization is not usually required. The very small plate to cathode capacitance permits a minimum of intercoupling on frequencies below 30 Mc. when inexpensive tetrode or pentode tubes are used. No screen or bias supplies are required.

Figure 22
REAR VIEW OF
MULTI-BAND
MOBILE LINEAR
AMPLIFIER

The three amplifier tank coils are connected between the variable vacuum capacitors and chassis ground. Plate voltage is shunt-fed to the linear amplifier tubes (4W-300B's or 4X-250B's). Antenna relay is at left. Extremely low harmonic content of class AB1 amplifier operation requires no TVI screening or other enclosure to prevent radiation of undesired harmonics.

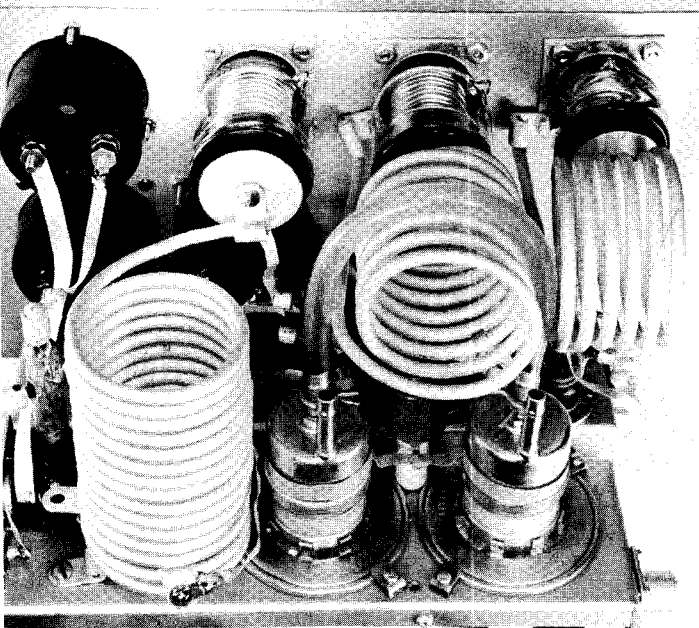

Feedthrough Power A large portion of the exciting power appears in the plate circuit of the cathode driven stage and is termed the *feedthrough* power. In any amplifier of this type, whether it be triode or tetrode, it is desirable to have a fairly large ratio of feedthrough power to peak grid driving power. The feedthrough power acts as a swamping resistor across the driving circuit to reduce the effect of grid loading. The ratio of feedthrough power to driving power should be at least 10 to 1 for best stage linearity.

Class AB1 Cathode Driven Amplifiers The only way that the advantages can be taken of the inherent feedback in a cathode driven amplifier is to drive it with a source having a high internal impedance and to operate the stage class AB1 without grid or screen current. It is a characteristic of class AB1 cathode driven (so-called "grounded grid") amplifiers that a variation in load impedance on the stage reflects back as a nearly proportional change at the input because the input and output circuits are essentially in series. In the same manner, a change in gain (such as may be caused by a nonlinearity of gain with respect to signal level) of a cathode driven stage reflects back as a change in the input impedance of that stage. If the cathode driven stage is fed by a source having high internal impedance such as a tetrode amplifier, changes in gain or nonlinearity in the cathode driven stage will be compensated for. For example, if the gain of the cathode driven stage drops slightly, the input impedance of the stage will increase and the load impedance on the driver stage will rise. If the driver has high internal impedance the output voltage will also rise when its load impedance rises. The increased output voltage will raise the output voltage of the cathode driven stage so that the output is nearly up to where it should be even though the gain of the cathode driven stage is low. The equivalent circuit for this action is shown in figure 24.

"True" class AB1 cathode driven amplifiers, however, have rather low stage gain and the use of low- μ triodes is required for reasonable efficiency. Such low gain circuits require more stages to reach a given power level. High driving voltage is required which is difficult to achieve in the cathode circuit. Since it seems impractical to operate most available tubes class AB1 in a cathode driven circuit (i.e., no grid current and no screen current) the possibility of taking advantage of the inherent feedback in the circuit is lost because a low driver

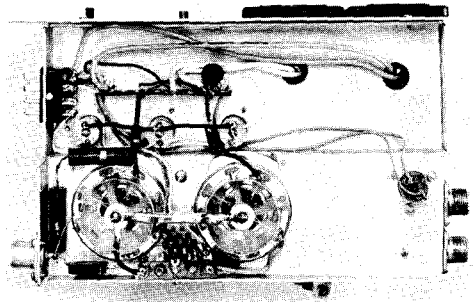

Figure 23
UNDER-CHASSIS VIEW OF MULTI-BAND LINEAR AMPLIFIER

Coaxial input receptacle is at left, with composition-type grid resistors. Simplicity of circuit requires relatively few components beneath the chassis. Grid terminals of sockets are connected with wide copper strap.

source impedance is then required to supply grid driving power for class AB2 operation. The latter class of operation offers stage gain figures of 10 to 25 with moderate values of cathode excitation voltage. The linearity, however, is approximately the same as for conventional grid driven circuits having low source impedance, and about 30 decibels signal-to-distortion ratio is the maximum that can be achieved.

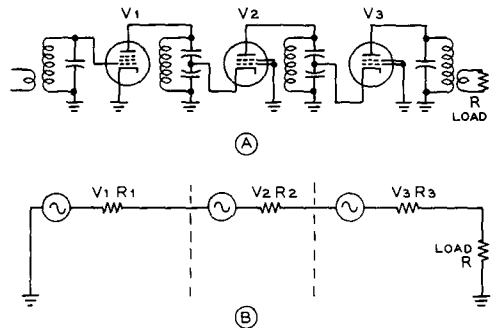

Figure 24
EQUIVALENT CIRCUIT OF CASCADE CLASS AB1 CATHODE DRIVEN AMPLIFIERS

- A—Cathode driven amplifiers may be arranged in cascade to provide high output levels. Any variation in load impedance (R) reflects back as nearly proportional change at the input, as input and output circuits are essentially in series as shown in figure B.
- B—Equivalent circuit of figure A. R_1 has a very high resistance, and R_2 and R_3 have very low resistances compared to the load R .

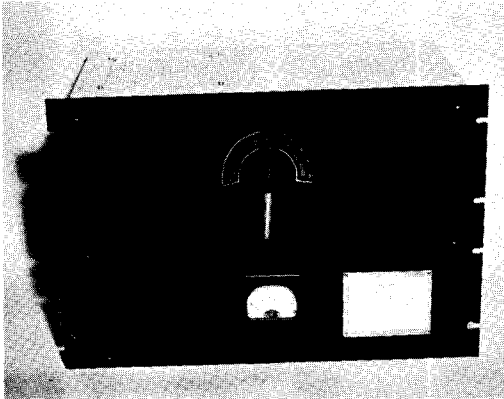

Figure 25

CATHODE DRIVEN KILOWATT AMPLIFIER FOR 40 AND 80 METERS

Cathode driven amplifier presents ultimate in simplicity and stability. Designed around two 803 tetrodes, this kilowatt amplifier for 40 and 80 meter operation has only plate tank tuning control and plate current meter on panel. Amplifier is completely enclosed for reduction of spurious radiation.

A Practical Cathode Driven Amplifier

Shown in figures 25, 27, and 28 is a cathode driven amplifier designed for 40 and 80 meter operation. It is capable of 1000 watts power input and may be employed for SSB, c.w., or a.m. phone. Combined grid driving and feedthrough power is approximately 110 watts for 1 kilowatt input. Actual grid driving power is of the order of 9 to 10 watts, so the ratio of feedthrough to drive power is about 10 to 1.

The schematic of the amplifier is shown in figure 26. Two 803 tetrode tubes are used in parallel in cathode driven configuration. These tubes are available on the surplus market for a dollar or so and perform very well up to approximately 10 Mc. All three grids of the tubes are returned to ground and the tubes operate in near zero bias condition. The internal screening of the tubes begins to deteriorate in the 15 Mc. region and amplifier instability may be encountered above 10 Mc. unless precautions are taken to ensure that the grids remain close to r-f ground potential.

When operating in the 3.5-7 Mc. region it is entirely possible to apply the r-f driving voltage directly to the filament circuit without the necessity of adding filament r-f chokes to isolate the driving voltage from the filament transformer. This makes for circuit simplicity and lower initial cost. If this circuit is used

with high frequency tubes such as the 813 and 7094, the use of filament chokes for operation above 7 Mc. is recommended.

This type of amplifier has a tendency toward parasitic oscillations in the 100 Mc. region at which point the inherent inductance of the ground paths begins to affect operation. Variations in grounding technique can eliminate the parasitic, but the addition of parasitic suppressors in the plate leads of the tubes makes the circuit relatively insensitive to variations in the ground return path.

Amplifier Construction

The amplifier is built upon a 10" x 19" x 4" aluminum chassis. The plate tuning capacitor C_1 is centered on the chassis with the two 803 tubes mounted to one side. The tube sockets are recessed below the chassis to bring the top of the tube base level with the top of the chassis. The plate r-f choke and bypass capacitors are mounted between the tubes. On the opposite side of the tank capacitor is the tank coil and the r-f thermocouple (figure 27).

In the under-chassis area the only components are the cathode current meter, the filament transformer, and the small parts associated with the filament circuit. Pins 2, 3, and 4 of each socket are grounded to the metal rods

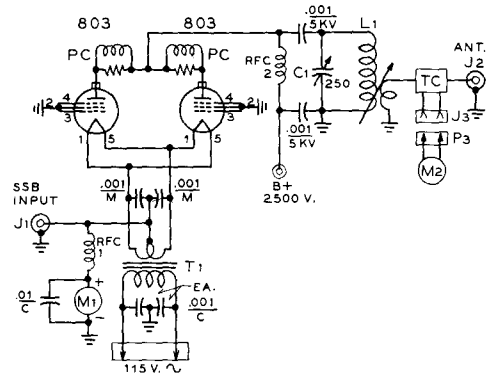
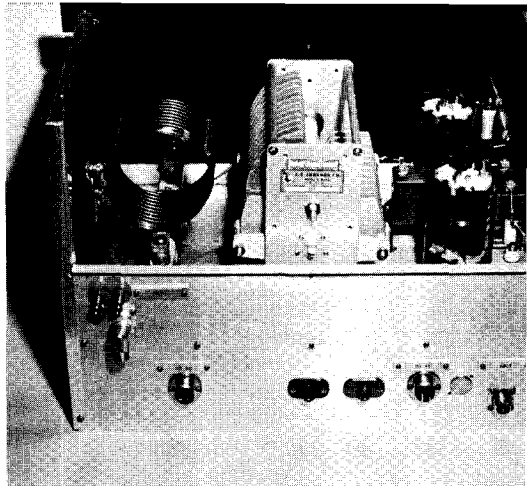

Figure 26
SCHEMATIC, CATHODE DRIVEN AMPLIFIER

- C_1 —250 μ fd., 5000 volt spacing
- L_1 —40 or 80 meter inductor. Cut to resonate to frequency with C_1 near full capacity. Antenna coil 5 turns.
- PC—40 ohm, 2 watt composition resistor wound with 6 turns #18 e. wire
- TC—R.f. thermocouple, 0-5 amperes
- T_1 —10 volts at 10 amperes. Stancor P-6461
- RFC—1.0 mh. Johnson 102-752
- RFC—Heavy duty plate choke. National R-175A
- M_1 —0-500 d.c. milliamperes
- M_2 —0-5 amperes, r.f. (Used with TC)

Figure 27
REAR VIEW, CATHODE DRIVEN
803 AMPLIFIER

Plate tuning capacitor is at the center, with tank coil to left. The 803 tubes (right) are mounted with sockets below deck, so that tops of bases are level with chassis. Plate r.f. choke is placed between tubes, with parasitic chokes (PC) supported from top terminal of choke.



supporting the sockets. The complete amplifier is enclosed in a shield made of aluminum. Holes are drilled above the 803 tubes in the top sheet (figure 25) and in the rear plate to permit circulation of air about the tubes.

Amplifier Operation The resting plate current of the amplifier under quiescent condition is between 30 ma. and 75 ma. depending upon the plate voltage, climbing to 450 ma. or so under full excitation at a plate potential of 2500 volts. Care should be taken in tune-up and full excitation should *never* be applied unless the amplifier is operating at rated plate voltage with maximum antenna loading. Applying full drive to the tubes with no plate voltage will surely cause damage to the grid structure of the tubes.

The meter indicates plate and screen current; actual plate current is about 40 milliamperes lower than the meter reading. At 1000 watts p.e.p., the power output measures approximately 600 watts. Tuning of the plate circuit is facilitated by means of a thermocouple r-f meter placed in the coaxial lead to the antenna coaxial receptacle.

29-8 A Low Distortion Sideband Linear Amplifier

A properly designed grounded grid linear amplifier is a very satisfactory high level stage for a sideband transmitter, even though the possibility of taking advantage of the inherent feedback is lost because of the reasons explained in Section 29-7 of this chapter. With care, a signal-to-distortion ratio of 30 decibels can easily be achieved and the circuit is unsurpassed for stability and ease of operation.

Data given in the tube manuals and instruction sheets are usually derived for maximum tube output rather than the condition of minimum distortion. It is therefore necessary to adjust circuit operating voltages to arrive at a satisfactory power output level consistent with a pre-set value of maximum allowable distortion. The maximum distortion level for this amplifier was set at 30 db S/D. At this figure 350 watts output p.e.p. can be obtained at 3000 volts plate potential, and 680 watts output p.e.p. can be obtained at 3500 volts.

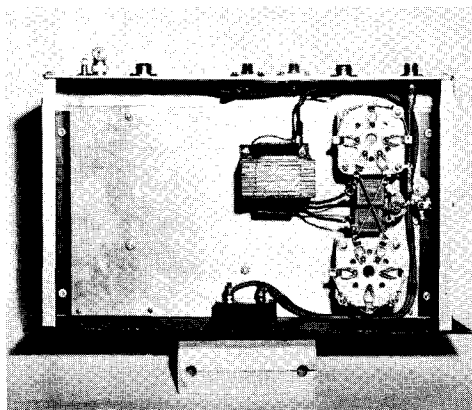

Figure 28
UNDER-CHASSIS VIEW OF CATHODE
DRIVEN AMPLIFIER

Input coaxial connector is at the right on rear of chassis. Mica filament bypass capacitors are placed between the tube sockets, with RFC₁ beneath them.

The Grounded Screen Configuration For maximum shielding within the tube, it is necessary to operate both grid and screen at r-f ground potential. At the same time, the control grid has a negative operating bias applied to it, and the screen has a positive operating potential. Both elements of the tube, therefore, must be bypassed to ground over a frequency range that includes the operating spectrum *and* the region of possible VHF parasitic oscillations. This is quite a large order. The inherent inductance of the usual bypass capacitors is sufficient to introduce sufficient regeneration into the circuit to degrade the linearity of the amplifier at high signal levels even though the instability is not great enough to cause parasitic oscillation. The

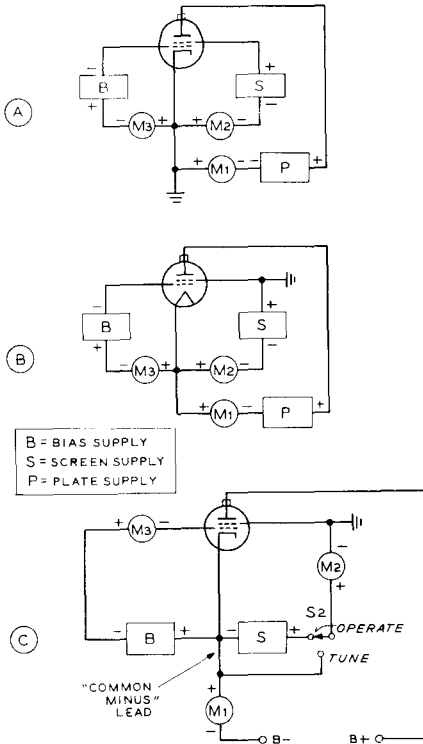

Figure 29
GROUNDING SCREEN GRID
CONFIGURATION PROVIDES HIGH
ORDER OF ISOLATION IN TETRODE
AMPLIFIER STAGE

- A**—Typical amplifier circuit has cathode return at ground potential. All circuits return to cathode.
- B**—All circuits return to cathode, but ground point has been shifted to screen terminal of tube. Operation of the circuit remains the same, as potential differences between elements of the tube are the same as in circuit A.
- C**—Practical grounded screen circuit. "Common minus" lead returns to negative of plate supply, which cannot be grounded. Switch S_2 removes screen voltage for tune-up purposes.

solution to this problem is to eliminate the screen bypass capacitors by actually grounding the screen terminals of the amplifier to the chassis by means of a low inductance strap. It is possible to do this by juggling the ground return of the amplifier, as shown in figure 29. Circuit A shows the conventional d.c. return paths wherein all power supplies are returned to the grounded cathode of the stage. Meters are placed in the common return leads, and each meter reads only the current flowing in the singular circuit. The d.c. ground lead is removed from the cathode in circuit B and

placed at the screen terminal of the tube. Circuit operation is still the same, as all power supply returns are still made to the cathode of the tube. The only change is that the screen r.f. ground and d.c. ground are now one and the same. The cathode circuit is now at a negative potential with respect to the chassis ground by an amount equal to the screen voltage. In addition, the return of the high voltage plate supply is now negative with respect to ground by an amount equal to the screen voltage supply.

A practical version of this circuit is shown in figure 29C. The grid bias and screen supplies are incorporated in the amplifier and separate terminals are provided for the positive and negative leads of the high voltage supply. A "tune-operate" switch S_2 is added to the circuit which removes the screen potential for tune-up purposes. The negative of the high voltage supply "floats below ground" at the value of the screen voltage.

This circuit is unique in that it requires a mental orientation of the user to accept the fact that d.c. ground is no longer "ground." However, the circuit is no more complex than the usual grounded cathode d.c. return circuit, and the advantage of having the screen at r.f. ground potential far outweighs the unusual aspects of the circuit. Operation of the circuit is normal in all respects, and it may be applied to any form of tetrode amplifier with good results.

The Amplifier Circuit

The circuit of an operational cathode driven, grounded screen amplifier is shown in figure 30. A 4-250A or 4-400A tetrode tube is used with an untuned cathode circuit and a pi-network plate circuit. Bias and screen supplies are included in the amplifier. The important operating parameters are also shown in the diagram. P.e.p. excitation is 12 watts (including losses) for 3000 volt operation and about 22 watts (including losses) for 3500 volt operation.

The resonant plate circuit is capacitively coupled to the amplifier tube and consists of a 300 $\mu\text{fd.}$ variable vacuum capacitor, a kilowatt tapped-coil turret, and a 1500 $\mu\text{fd.}$ variable air-type loading capacitor. D.c. ground is established by returning the output section of the network to ground by means of choke RFC-3. Three .001 $\mu\text{fd.}$, 5 KV ceramic capacitors in parallel form the plate blocking capacitor. The high voltage is applied to the tube via a Raypar heavy duty r.f. choke in series with two air wound VHF choke coils. Escape

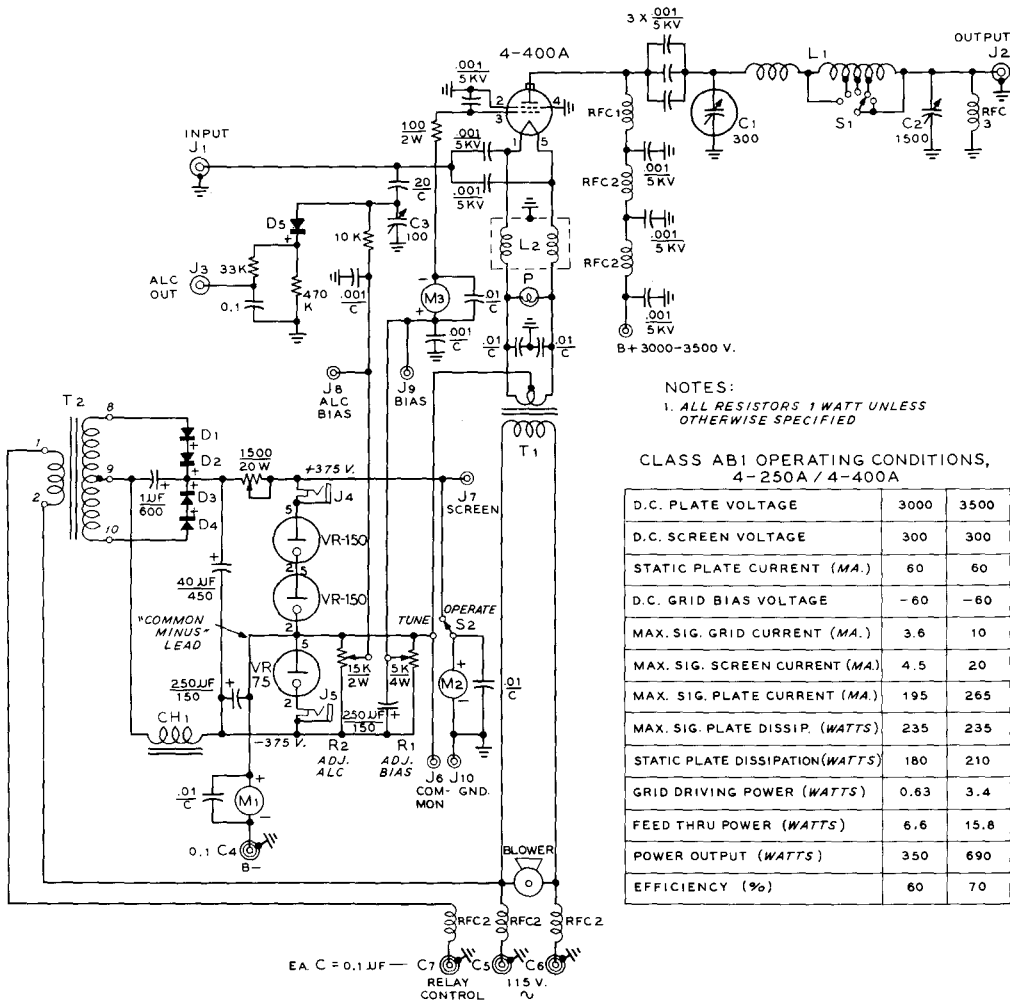

Figure 30

SCHEMATIC, LOW DISTORTION LINEAR AMPLIFIER

- C₁—300 μfd., 10KV variable vacuum capacitor. Jennings UCS-300
- C₂—1500 μfd., variable capacitor. Cardwell 8013
- C₃—100 μfd. variable ceramic
- C₄-C₇—0.1 μfd., 600 volt bulkhead-type capacitor. Sprague "Hypass"
- L₁-S₁—Barker & Williamson #850 pi-network inductor. Inductances: 80 meters, 13.5 μh.; 40 meters, 6.5 μh.; 20 meters, 1.75 μh.; 15 meters, 1 μh.; 10 meters, 0.8 μh.
- L₂—Dual winding filament choke. B&W FC-15, 15 amperes capacity
- T₁—5 volts at 10.5 amperes. Stancor P-6135
- T₂—335 - 0 - 335 volts, 75 ma. Chicago PSC-70
- CH—8 henry, 85 ma. Stancor C-1709
- D₁-D₄—500 ma. silicon rectifier. Sarks-Tarzian M-500
- D₅—Diode, type 1N67 or equivalent
- M₁—0 - 800 ma. d.c. meter. Marion type MM3
- M₂—0 - 50 ma. d.c. meter. Marion type MM3
- M₃—0 - 50 ma. d.c. meter. Marion type MM3
- RFC₁—Heavy duty wide band r.f. choke, 800 ma. Raypar RL-100
- RFC₂—20 turns #20e, airwound, 1/2" diam, 1" long
- RFC₃—2.5 mh. National R-100

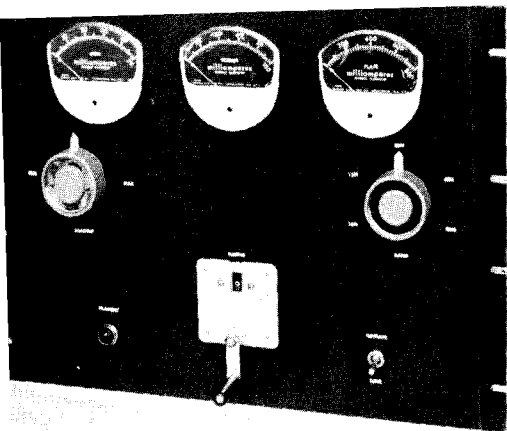

Figure 31
KILOWATT CATHODE-DRIVEN
AMPLIFIER

Careful arrangement of components permits symmetrical panel layout. Grid, screen, and plate current meters are spaced across top of panel, with amplifier loading control (C_2) at left, and plate bandswitch (S_1) at right. Counter dial at center drives variable vacuum capacitor C_1 . Tune-operate switch S_2 is at lower right, balanced on left by pilot light. Amplifier is completely screened to reduce spurious energy radiation. Screened area on top of shield allows circulation of air around tube.

of r.f. energy through this lead is thus held to an absolute minimum value.

Driving power is coupled to the filament circuit of the tube through two .001 μ fd. ceramic capacitors. The filament transformer is isolated from the exciting voltage by means of a bifilar wound r.f. choke coil, capable of carrying the filament current of the tube (10.5 amperes).

A dual purpose power supply delivering 375 volts serves as screen and bias source. The output voltage of the supply is held constant by three regulator tubes in series. The "common minus" lead (see figures 29 and 30) is at the juncture of the regulated -75 volts and the regulated 300 volts. The supply thus delivers -75 volts for the bias circuit and plus 300 volts for the screen circuit. The exact value

of bias voltage may be set by adjusting potentiometer R_1 .

A simple automatic load control circuit is incorporated in the input circuit of the amplifier. A diode samples the incoming signal and produces a d.c. signal proportional to the input signal. This control voltage may be applied to an amplifier tube in the sideband exciter in such a way as to limit the incoming signal to a predetermined value which may be set by adjustment of capacitor C_3 and potentiometer R_2 . This circuit is analogous to the automatic volume control circuit in a receiver. The time constant of the a.l.c. circuit is determined by the 0.1 μ fd. capacitor and 33K resistor across the output jack, J_3 .

Amplifier Construction The amplifier is built upon an aluminum chassis measuring 13" x 17" x 4". The front panel is 13 $\frac{3}{4}$ " high, and the above-chassis

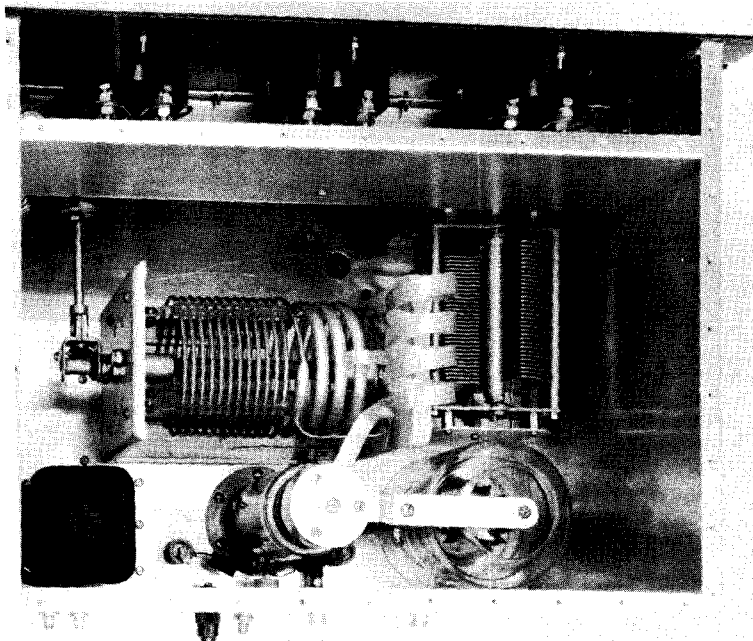

Figure 32
TOP VIEW OF
KILOWATT
AMPLIFIER USING
4-400A TETRODE

Plate circuit inductor is placed parallel to panel and driven by right-angle drive unit. Loading capacitor is at right, with variable vacuum capacitor mounted vertically at rear of chassis. 4-400A tube and air socket are at rear right corner of chassis, with bias transformer in left corner. Plate blocking capacitors are placed between aluminum plates and mounted atop vacuum capacitor. Plate r-f choke is hidden between tube and variable vacuum capacitor. At base of capacitor are the B-plus VHF filter chokes and bypass capacitors.

Meters are isolated by aluminum shield running full length of chassis. Meter leads pass down conduit (left corner) to under-chassis area. Shield plate covers entire enclosure.

**Figure 33
UNDER-CHASSIS
VIEW OF
CATHODE-DRIVEN
AMPLIFIER**

Bias and screen supply, and input circuits are placed in the under-chassis area. Filament transformer and filament choke are at left, with tube socket next to the choke. Screen terminals of socket are grounded with wide aluminum strap passing across terminals to socket shell and chassis. Grid terminal is bypassed to center of strap. Input capacitors mount between filament terminals and coaxial input receptacle on rear of chassis.

At right are power supply compartment (see figure 34) and voltage regulator tubes. Vacuum capacitor gear drive and output circuit voltmeter are at center of chassis. Blower motor is next to filament transformer. Under-chassis area is pressurized so that air escapes through tube socket vent. After bottom plate is in place, seam around plate is sealed with cellophane tape to provide air-tight enclosure.

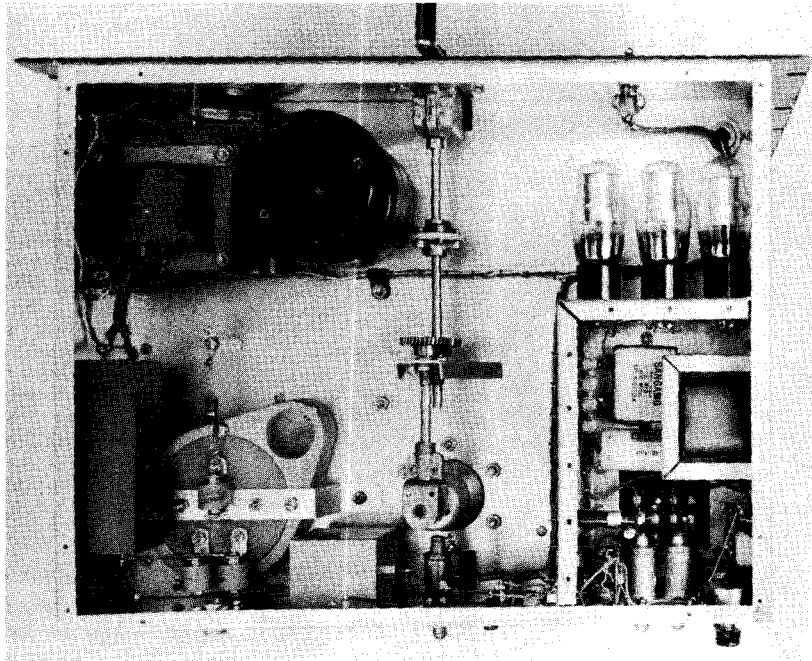

shield is $9\frac{3}{8}$ " high. This shield is made of one piece of aluminum, bent into a U-shape, having $\frac{1}{2}$ -inch flanges on all sides. The open side of the "U" is bolted to the front panel as shown in the photographs. Elastic stop-nuts are affixed to the shield every $1\frac{1}{2}$ " along the flange, or it may be drilled and tapped for 6-32 machine screws. A shield of this type can be homemade, or it may be fabricated in any large sheet metal shop for a small sum.

The three indicating meters are mounted on the top front of the panel and are shielded from the intense r.f. field of the amplifier by a half-box section of shielding bent to fit around the rear of the meter cases. The meter shield measures $2\frac{1}{2}$ " deep, $4\frac{1}{4}$ " high, and is long enough to make a close fit with the outer shield at each end. Meter leads pass from the under-chassis area through the upper deck via a short section of $\frac{1}{2}$ -inch pipe, threaded at each end and bolted between the chassis deck and the meter shield.

The major components are mounted with an eye towards panel symmetry and short leads. The vacuum tube socket and variable vacuum capacitor C_1 are placed to the rear of the chassis. The capacitor is mounted in a vertical position, gear driven from the under-chassis area (figure 33). Plate choke RFC-1 is placed between the air socket and the capacitor. Direct-

ly in front of the tube is the panel driven 1500 $\mu\text{mfd.}$ loading capacitor C_2 , mounted on two heavy aluminum brackets, bringing its shaft in line with that of the variable inductor, L_1 .

Plate inductor L_1 is affixed to the chassis parallel to the front panel, and is driven through a miniature right angle drive, as seen in figure 32, making the control knobs of L_1 and C_2 occupy symmetrical positions on the panel.

The variable vacuum capacitor is centered between the sides of the chassis and is panel driven by a counter dial and a right angle drive unit. To preserve the panel appearance, the counter dial is mounted with its shaft about $2\frac{5}{8}$ " above the lower edge of the panel. The center-line of the right angle drive unit, however, falls about $1\frac{3}{8}$ " above the panel edge. Two $1\frac{1}{4}$ " brass gears are used to couple the shafts, as seen in figure 34. The gears are held in position by an angle plate cut from a soft aluminum sheet.

The Tube Socket An *Eimac* air cooled socket is used for the amplifier tube. The small 115 volt a.c. blower motor is mounted near the socket, and the entire under-chassis area is sealed air-tight with a bottom plate. A $\frac{3}{4}$ " wide aluminum strap passes across the center of the socket, extending down

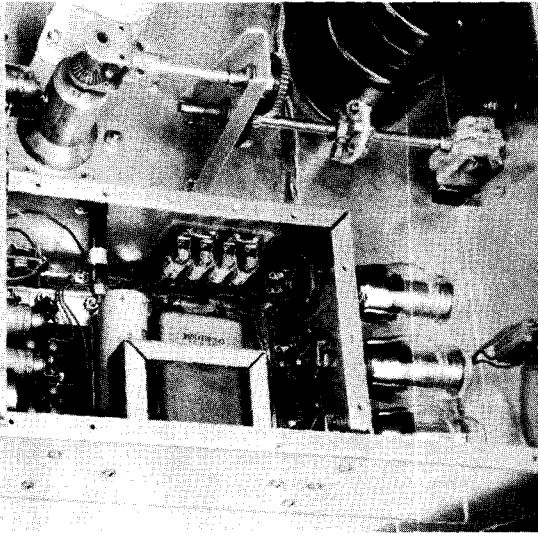

Figure 34
CLOSE-UP OF POWER SUPPLY
COMPARTMENT AND GEAR
DRIVE SYSTEM

Off-center shafts of capacitor and counter dial are ganged by two gears held in position by triangular plate bolted to chassis. Enclosure below holds power supply components. Silicon rectifiers are mounted in fuse clips attached to enclosure wall. All power leads leaving enclosure pass through small, bulk-head-type ceramic capacitors. Primary leads pass through "Hypass" capacitors on rear wall of chassis. Potentiometers R_1 and R_2 are in corner of chassis.

to the chassis on both sides. This strap is bolted to the two screen terminals of the socket, and to the two diagonal assembly screws of the socket frame. The ends of the strip are fastened to the chassis, forming a low impedance return path for the screen circuit. The .001 $\mu\text{fd.}$, 5 KV ceramic grid bypass capacitor is mounted directly between the ground strap and the grid terminal of the tube socket.

The r.f. input jack J_1 is mounted to the rear wall of the chassis directly behind the tube socket and two .001 $\mu\text{fd.}$ ceramic capacitors are connected between the center terminal of J_1 and each filament terminal of the tube socket. Short leads connect the filament terminals to the filament choke coil L_2 mounted on the side wall of the chassis, directly above the tube socket. The power supply components are encased within an auxiliary shield measuring 5" x 7 1/2" (figure 34). All leads leaving this enclosure pass through .001 $\mu\text{fd.}$ ceramic feed-through capacitors mounted on the wall of the enclosure. The four silicon rectifiers are mounted in a multiple fuse clip holder placed on the side wall, and the three regulator tubes are mounted on the adjacent wall.

Amplifier Wiring and Tuning

The power circuits of the amplifier may be wired with unshielded wire since the r.f. field beneath the chassis is extremely low. All d.c. leads are cabled and laced as may be seen in the under-chassis photograph. Leads to the meter deck pass through the area above the chassis in a short section of 1/2-inch alum-

inum conduit, and each meter is bypassed as shown in the schematic. Small insulated tip jacks (J_6 - J_{10}) are mounted on the rear of the chassis to facilitate voltage measurements. In addition, two insulated, closed-circuit jacks (J_4 , J_5) allow the voltage regulator currents to be read.

Choke coils RFC-2 are wound on a 3/8-inch wooden dowel rod which is removed, leaving the coils self-supporting. Plate circuit wiring above the deck is done with silver plated copper strap.

When the amplifier wiring is completed the power supply should be checked. The regulator tubes are inserted in the correct sockets and the current flowing through the regulator circuit is measured. The 1500 ohm series resistor in the power supply is adjusted to provide 40 milliamperes of screen regulator current. If the correct current value is obtained with less than 500 ohms of series resistance, the 1 $\mu\text{fd.}$ input filter capacitor should be increased in value to 8 $\mu\text{fd.}$ to boost the supply voltage. The regulator current divides between the VR-75 and the bias adjust potentiometer R_1 , and 25 milliamperes of regulator current is measured at J_5 when the supply is adjusted for 40 ma. at jack J_4 . After final adjustment has been completed, the variable series resistor in the supply may be replaced with a fixed one if desired. Finally, bias control potentiometer R_2 is set for -60 volts as measured between J_6 (minus) and J_7 (plus).

Switch S_2 should be placed in the "tune"

Figure 35
GENERAL PURPOSE AMPLIFIER
OPERATES IN CLASS A, B, OR C
MODE

This kilowatt amplifier employs a pair of 4-250A's in a pi-network circuit. Mode of operation may be set by selection of proper screen and bias voltages. Grid, plate, and screen current meters are mounted on plastic screen behind panel cut-out, and tubes are visible through shielded panel opening. Across bottom of panel (left to right) are band-switch, grid tuning, plate tuning, loading, and primary power control circuits. Plate tuning knob is attached to small counter dial.

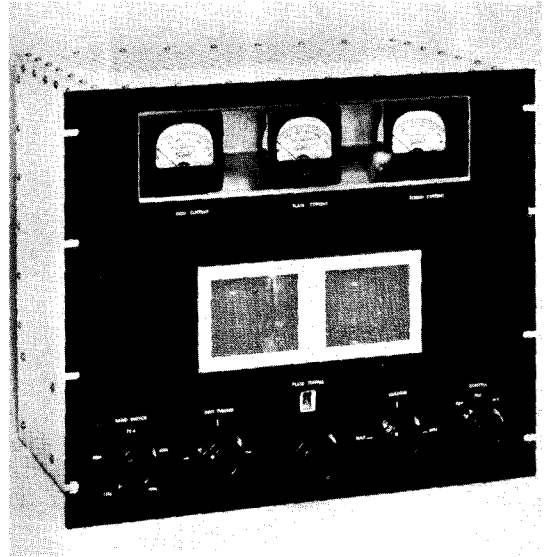

position before voltages are applied to the tube. A suitable antenna load should be placed on the amplifier; bias, screen, and plate voltage are applied. The bias control should be varied slightly to produce the correct resting plate current, as indicated in figure 30. Excitation should never be applied without plate voltage on the amplifier, or without an external antenna load, since the resultant high grid and screen current would damage the tube. In addition, screen voltage should never be applied without plate voltage. The combination screen and bias supply of the amplifier is designed to be turned on with the plate supply through the "relay control" terminal. All voltages may be left on the amplifier during "VOX" operation, or the supplies may be turned on by the "VOX" circuit. The "tune-operate" switch S₁ should not be thrown when excitation is applied to the tube, since the momentary breaking of the screen to ground path will apply the full excitation power to the control grid of the tube during the moment the switch is in transition from one position to the other. In practice, this switching action has been done with full excitation applied to the tube, but it is not recommended.

The exciter should now be connected and a small amount of carrier is inserted. The plate resonant point is found with tuning capacitor C₁ and the amplifier loading adjustments are made, gradually increasing the excitation and loading until the single tone conditions outlined in figure 30 are met. Speaking into the microphone should produce approximately the same peak conditions as obtained with carrier insertion. The linearity of the amplifier may be checked with the use of two envelope detectors as described in an earlier chapter.

29-9 Kilowatt Amplifier for Linear or Class C Operation

A pair of 4-250A or 4-400A tetrode tubes may be employed in a pi-coupled amplifier capable of running one kilowatt input, c-w or plate modulated phone, or two kilowatts p.e.p. for sideband operation. Correct choice of bias, screen, and exciting voltages will permit the amplifier to function in either class A, B, or class C mode. The amplifier is designed to operate at plate potentials up to 4000 volts, and excitation requirements for class C operation are less than 25 watts.

A bandswitching type of pi-network is employed in the plate circuit of such an amplifier, shown in figure 35. The pi-network is an effective means of obtaining an impedance match between a source of r.f. energy and a low value of load impedance. A properly designed pi-network is capable of transformation ratios greater than 10 to 1, and will provide approximately 30 decibels or more attenuation to the second harmonic output of the amplifier as compared to the desired signal output. Since the second harmonic level of the amplifier tube may already be down some 20 db, the actual second harmonic output of the network will be down perhaps 50 db from the fundamental power level of the transmitter. Attenuation of the third and higher order harmonics will be even greater.

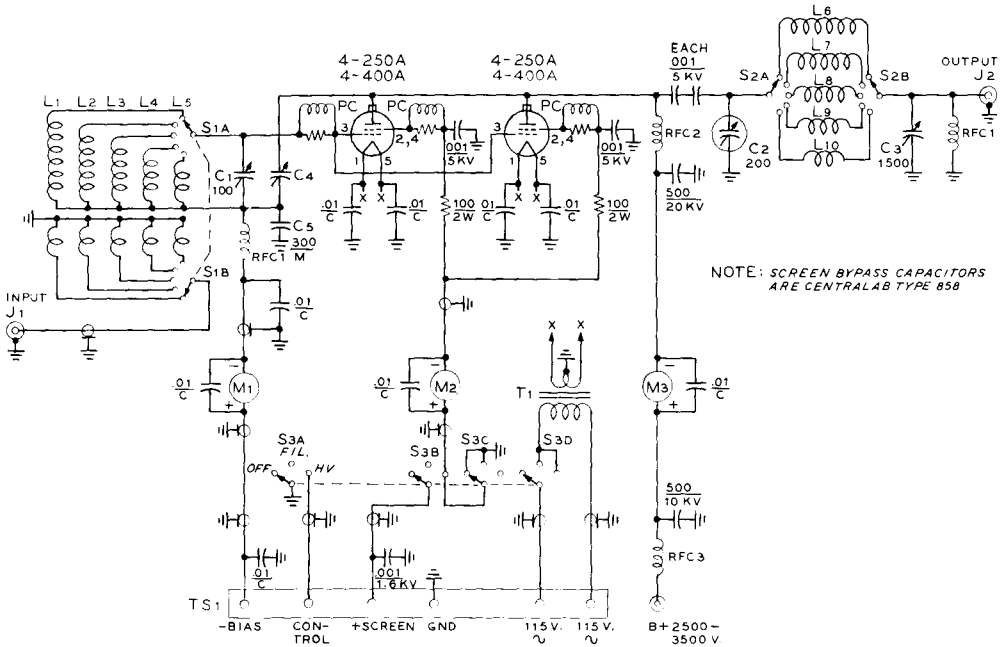

Figure 36
SCHEMATIC, GENERAL PURPOSE KILOWATT AMPLIFIER

- | | | | |
|--|--|---|--|
| <p>C₁—100 μfd. Hammarlund HF-100</p> <p>C₂—200 μfd., 10KV variable vacuum capacitor. Jennings UCS-200</p> <p>C₃—1500 μfd., variable capacitor. Cardwell 8013</p> <p>C₄—Neutralizing capacitor, disc. Millen 15011</p> <p>C₅—300 μfd., mica, 1250 volt</p> <p>L₁-L₁₀—See coil table, figure 39</p> | <p>PC—47 ohm, 2 watt composition resistor wound with 6 turns #18e.</p> <p>RFC₁—2.5 mh. choke. National R-100</p> <p>RFC₂—Heavy duty, wide-band r.f. choke. Barker & Williamson type 800</p> <p>RFC₃—VHF choke. Ohmite Z-144</p> | <p>S₁—Two pole, 6 position switch. Two Centralab PA-17 decks, with PA-301 index assembly</p> <p>S₂—Two pole, 6 position high voltage switch. Communication Products Co. type 88 two gang switch</p> <p>S₃—Four pole, three position switch. Centralab</p> | <p>T₁—5 volt, 20 ampere. Stancor P-6492</p> <p>M₁—0 - 50 ma. d.c. Triplett</p> <p>M₂—0 - 150 ma. d.c. Triplett</p> <p>M₃—0 - 750 ma. d.c. Triplett</p> <p>Gears—2 required. Boston Gear #G-465 and #G-466</p> |
|--|--|---|--|

The peak voltages encountered across the input capacitor of the pi-network are the same as would be encountered across the plate tuning capacitor of a single-ended tank used in the same circuit configuration. The peak voltage to be expected across the output capacitor of the network will be less than the voltage across the input capacitor by the square root of the ratio of impedance transformation of the network. Thus if the network is transforming from 5000 ohms to 50 ohms, the ratio of impedance transformation is 100 and the square root of the ratio is 10, so that the voltage across the output capacitor is 1/10 that across the input capacitor.

A considerably greater value of maximum capacitance is required of the output capacitor than of the input capacitor of a pi-network when transformation to a low impedance load is desired. For 3.5 Mc. operation, maximum values of output capacitance may run from

500 μ fd. to 1500 μ fd., depending upon the ratio of transformation. Design information covering pi-network circuits is given in an earlier chapter of this Handbook.

Illustrated in figures 35-41 is an up-to-date version of an all-band pi-network amplifier, suited for sideband or class-C operation. The unit is designed for TVI-free operation over this range.

Circuit Description The schematic of the general purpose amplifier is shown in figure 36. The symmetrical panel arrangement of the amplifier is shown in the front view (figure 35) and the rear view (figure 37). A 200 μ fd. variable vacuum capacitor is employed in the input side of the pi-network, and a 1500 μ fd. variable air capacitor is used in the low impedance output side. The coils of the network are switched in and out of the circuit by a two pole, five

Figure 37
REAR VIEW OF GENERAL PURPOSE
AMPLIFIER WITH SHIELD
REMOVED

The pi-network circuit is built from an inexpensive high voltage rotary switch, and five inductors. The switch is panel driven by a gear and shaft system shown in figure 38. Variable vacuum capacitor is mounted vertically between the tubes, directly in back of the plate r.f. choke. Neutralizing capacitor is at right, connected to plates of tubes with a wide, silver plated copper strap. Meters are enclosed by aluminum shield partition running the width of the enclosure, with conduit carrying meter loads to under-chassis area at left, front of chassis. Metal shells of tube bases are grounded by spring contacts.

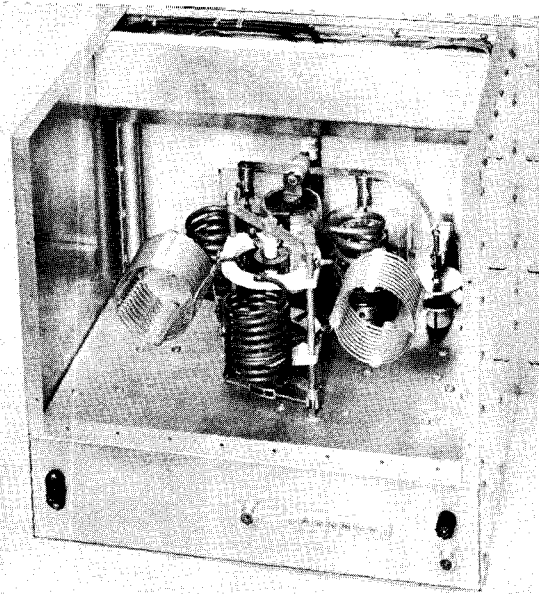

position high voltage ceramic rotary switch. Each coil is adjusted for optimum circuit Q, resulting in no tank circuit compromise in efficiency at the higher frequencies. A close-up of the tank circuit is shown in the introductory photograph at the chapter head, and complete coil data is given in figure 39. The plate blocking capacitor is made of two .001 μ fd., 5 KV ceramic capacitors connected in series.

Special precautions are taken to insure operating stability over the complete range of amplifier operation. The screen terminals of each tube socket are jumpered together with $\frac{3}{8}$ " copper strap and a parasitic choke (PC) is inserted between the center of the strap and the screen bypass capacitor. In addition, sup-

pressor resistors are placed in the screen leads after the bypass capacitor to isolate the sensitive screen circuit from the external power leads. A third parasitic choke is placed between the grid terminals of the tubes and the tuned grid circuit.

The five coils of the grid circuit are enclosed in a small aluminum shield placed adjacent to the tube sockets (figure 38 and figure 40). The amplifier is neutralized by a capacitive bridge system consisting of neutralizing

Figure 38
PLACEMENT OF
PARTS IN UNDER-
CHASSIS AREA

Grid tuned circuit is enclosed in separate enclosure at left. Bandswitch projects out the rear of case, and is gear driven by same shaft that actuates the plate bandswitch. Switches are driven through right-angle gear drives and gears. Output capacitor of pi-network is shielded from rest of under-chassis components.

The screen terminals of each tube socket are strapped together with $\frac{3}{8}$ " copper ribbon, and low inductance screen bypass capacitor is grounded to socket mounting bolt. Screen parasitic choke mounts between strap and capacitor terminal. All power leads beneath the chassis are run in shielded braid, grounded to chassis at convenient points. B-plus lead is made of section of RG-8/U coaxial cable, with outer sheath and braid removed.

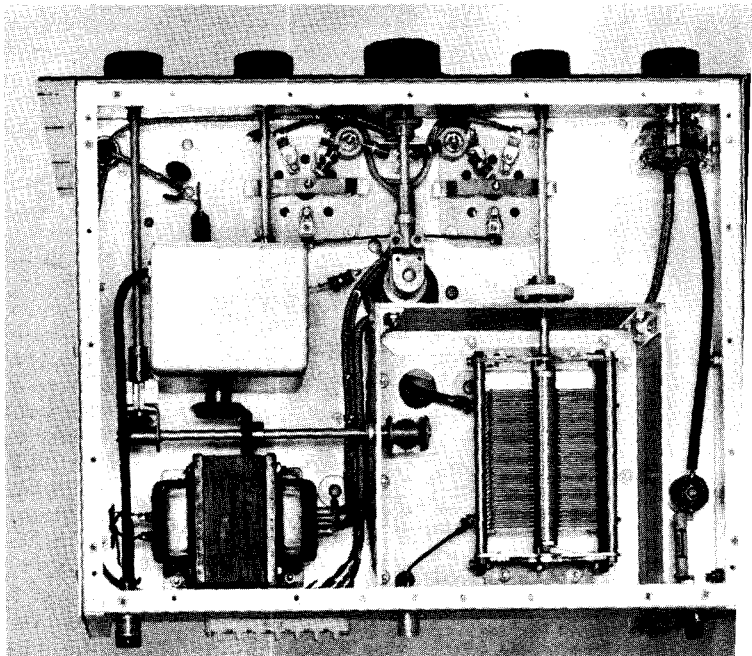

FIGURE 39 COIL TABLE FOR KILOWATT AMPLIFIER	
GRID COILS	
L1-(80 METERS):	46 TURNS #24 E, 3/4" DIA., 1" LONG ON AMPHENOL POLYSTYRENE FORM.
L2-(40 METERS):	30 TURNS #24 E, 3/4" DIA., 3/4" LONG ON AMPHENOL POLYSTYRENE FORM.
L3-(20 METERS):	12 TURNS, B&W 3011 MININDUCTOR, 3/4" DIA., 3/4" LONG.
L4-(15 METERS):	7 TURNS, B&W 3010 MININDUCTOR, 3/4" DIA., 7/8" LONG.
L5-(10 METERS):	5 TURNS, AS ABOVE.
ALL COILS HAVE 3 TURN LINKS MADE OF HOOKUP WIRE.	
PLATE COILS	
L6-(80 METERS):	17 TURNS #10, 3" O.D., 6 TURNS PER INCH "AIR-DUX"
L7-(40 METERS):	10 TURNS #10, 3" O.D., 5 TURNS PER INCH
L8-(20 METERS):	9 TURNS, 3/16" COPPER TUBING, 2 1/2" O.D., 3" LONG.
L9-(15 METERS):	7 TURNS, 1/4" COPPER TUBING, 2 1/4" O.D., 3" LONG.
L10-(10 METERS):	5 TURNS, 1/4" COPPER TUBING, 2 1/4" O.D., 3" LONG.

capacitor C_1 and C_2 , the grid circuit bypass capacitor.

Screen voltage may be removed for tune-up purposes by control switch S_3 , section B. The screen circuit is grounded in the "off" and "fil" positions by means of switch section C.

Amplifier Construction The complete amplifier is built upon an aluminum chassis measuring 13" x 17" x 3" and has a 14" standard relay rack panel. The

grid circuit components are mounted within an aluminum box measuring 3" x 4" x 4". Plate loading capacitor C_3 , r.f. choke RFC-1, and output connector J_2 are placed within an enclosure measuring 6" x 6" x 3", made up of aluminum angle sections and sheet material. The plate circuit shielding is made of *Reynold's "Do-it-yourself"* aluminum stock, available at most hardware stores.

Layout of the major components can be seen in figure 37. The two tube sockets are placed directly behind the panel opening, with the plate r.f. choke between them, and the variable vacuum capacitor is mounted vertically to the chassis directly behind the sockets, on the center line of the chassis. To the right of the sockets is neutralizing capacitor C_4 . The high voltage ceramic coil switch S.A-B is placed directly behind the vacuum capacitor, mounted in a vertical position.

The variable vacuum capacitor is panel driven by a counter-type dial, through a miniature right angle gear drive, as seen in the under-chassis view (figure 38). The plate and grid band switches are ganged and switched in unison by means of a shaft acting through two right angle gear drives and two bevel gears. Both circuits are thus switched by the "Band-switch" control located in the lower left corner of the front panel.

It is necessary to apply forced air to the sockets of the amplifier tubes. A large 115 volt a.c. operated blower is therefore mounted in the center of the bottom shield plate. The under-chassis area is thus pressurized and the majority of the air escapes through the socket ventilation holes located near the pins of the tubes.

All wiring beneath the chassis (with the exception of the filament leads) is done with 5KV insulated wire, encased in metallic braid which is grounded to the chassis every inch or so. The B-plus wiring from the high voltage terminal to the plate current meter is done with a section of RG-8/U coaxial line from which the outer braid has been removed. A similar piece of line is run from the meter to the plate r.f. choke, RFC-2.

The three meters are mounted upon a lucite sheet placed behind a second lucite sheet mounted behind a cut-out in the front panel. The meters are shielded from the plate circuit of the amplifier by an aluminum enclosure that covers the wiring and meters, running the full length of the chassis. The meter leads pass through the plate circuit area via a short length of 1/2-inch aluminum conduit that is threaded

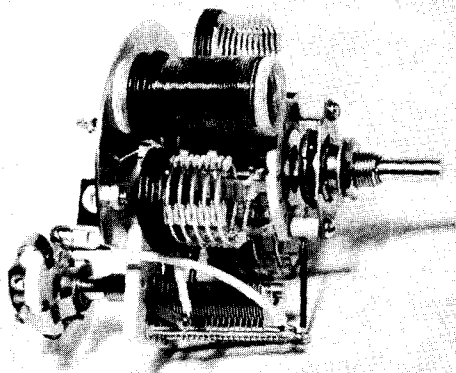

Figure 40
GRID TANK CIRCUIT ASSEMBLY

Coils are mounted to the ceramic switch decks by their leads. A small aluminum plate attached to rear of the switch assembly rods supports grid tuning capacitor which projects out rear of shielded enclosure. Entire assembly may be pre-wired before placing in enclosure.

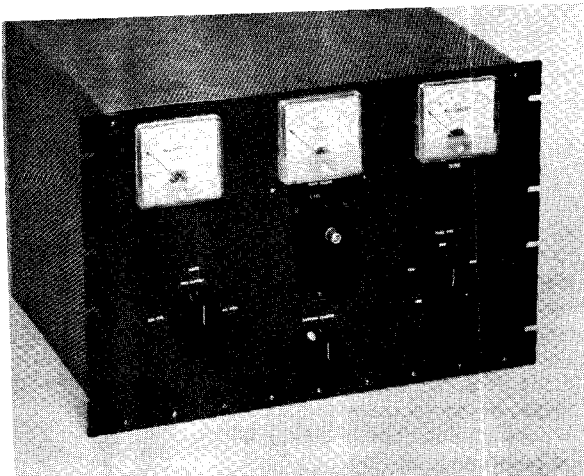

Figure 42

4CX-1000A ALL BAND AMPLIFIER PROVIDES TWO KILOWATT P.E.P. FOR SIDEBAND, OR ONE KILOWATT FOR PHONE C.W. OPERATION

Grid, plate, and output meters are across top of panel. Counter dial at center drives variable vacuum tuning capacitor, with loading control directly beneath it. Meter switch is at left, with bandswitch at right. Entire amplifier is screened to reduce unwanted radiation.

circuit whenever the screen current reaches approximately 100 milliamperes.

rode amplifier tubes be protected from excessive current that could occur during tuning adjustments, or during improper operation of the amplifier. The safest way to accomplish this is to include an overload relay that will open the screen circuit whenever the maximum screen dissipation point is reached. Two 4-250A tubes or 4-400A tubes have a total screen dissipation rating of 70 watts, therefore relay RY-1 should be adjusted to open the screen

29-10 A 2 Kilowatt P.E.P. All-band Amplifier

Described in this section is an efficient all-band linear amplifier suited for SSB, phone, and c.w. operation up to the maximum legal power input limit. A 4CX-1000A ceramic power tetrode is employed in the basic circuit shown earlier in this chapter in figure 11C.

The *Eimac* 4CX-1000A is a ceramic and

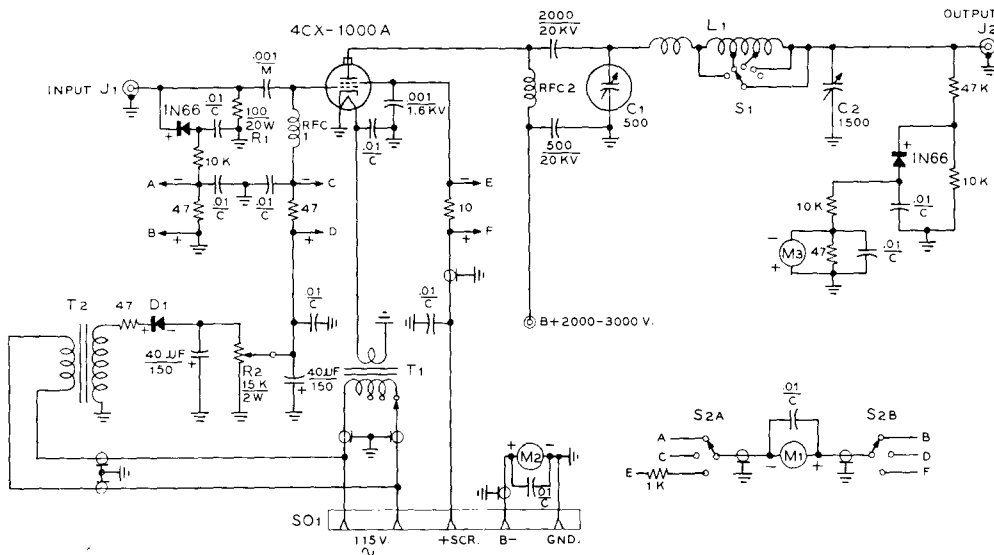

Figure 43

SCHEMATIC, 4CX-1000A LINEAR AMPLIFIER

- C₁—500 μ fd., 10KV variable vacuum capacitor. Jennings UC5L 4-500
- C₂—1500 μ fd. Cardwell 8013
- L₁—S—High-C, all-band turret. Barker & Williamson 852
- RFC₁—2.5 mh. National R-100
- RFC₂—Heavy duty plate choke. Raypar RL-100
- T₁—6 volts, 12.5 amperes, with primary taps. Stancor P-6463
- T₂—125 volts, 15 ma. Stancor PS-8415
- R₁—100 ohm, 20 watt non-inductive resistor. May be made of a number of 2 or 4 watt composition resistors connected in series parallel. Two Sprague type NIT, 10 watt "Cool-ohm" 200 ohm resistors in parallel used.
- M₁, M₂—0 - 1 d.c. milliammeter
- M₂—0 - 1 d.c. ammeter
- Eimac SK-800 air socket

Figure 44
END VIEW OF AMPLIFIER

4CX-1000A sub-chassis is shown, with plate circuit choke mounted at rear. External blower provides forced air to cool tube seals via entrance hole in rear of chassis. Bias adjustment potentiometer is in foreground, between tube and meter switch.

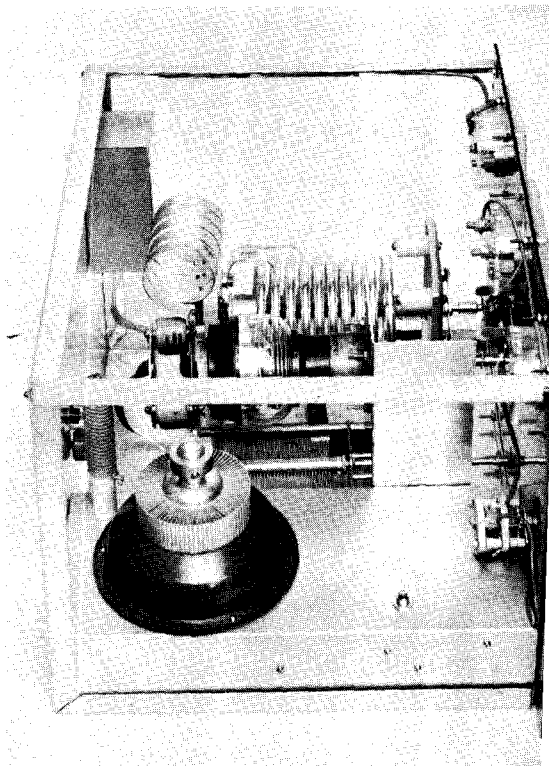

metal, forced air-cooled, radial beam tetrode with a rated maximum plate dissipation of 1000 watts. It is a low voltage, high current tube specifically designed for class AB1 r-f linear amplifier service where its high gain and low distortion characteristics may be used to advantage. At its maximum rated plate voltage of 3000, it is capable of producing 1680 watts of single-tone output power in SSB service. Maximum grid dissipation of the 4CX-1000A is zero watts. The design features which make the tube capable of maximum power operation without driving the grid into the positive region also make it necessary to avoid positive grid operation.

Circuit Description The circuit of the all-band amplifier is shown in figure 43.

A resistance loaded, untuned grid input circuit is employed in conjunction with a pi-network plate output circuit. Grid driving requirements are 60 volts peak across resistor R_1 which has a value of 100 ohms. This corresponds to 36 watts p.e.p. all of which is dissipated in resistor R_1 . For normal voice operation, a 20 watt non-inductive resistor may be used. A simple 1N66 diode voltmeter is incorporated in the grid circuit to monitor the excitation voltage. Grid and screen current are also measured. The d.c. grid bias voltage is obtained from a small selenium-type half-wave power supply contained within the amplifier.

The plate circuit is designed around the new *Barker & Williamson type 852* bandswitching turret, especially designed for high current, low voltage tubes of this type. The input tuning capacitor of the network is a 500 μmf . variable vacuum unit, and the output loading control is a 1500 μmf . variable air capacitor. For operation into low impedance loads in the 80 meter band, an additional 1500 μmf . fixed mica capacitor may be placed in parallel with the output loading capacitor, C_s . A second 1N66 diode voltmeter is placed across the output circuit as a tuning aid.

Screen Grid Operation Tetrode tubes may exhibit reversed (negative) screen current to a greater or lesser degree depending upon individual tube design. This characteristic is prominent in the 4CX-1000A and, under some operating conditions, indicated negative screen current of the order of 25 milliamperes may be encountered. In general, high values of negative screen current will be measured at the lower values of plate potential.

It is difficult to measure screen dissipation in the presence of secondary emission of this type. The usual product of current and voltage may not provide an accurate picture of actual screen dissipation. Experience has shown that the screen will operate within the limits established for this tube if the indicated screen current, plate voltage, and drive voltage approximate the values given in the operating chart of figure 48.

The screen supply voltage must be maintained constant for any values of negative and positive screen current that may be encountered. Dangerously high plate currents may flow if the screen power supply exhibits a rising voltage characteristic with negative screen cur-

rent. Stabilization may be accomplished in several ways. A combination of voltage regulator tubes may be connected across the screen supply, or a heavy bleeder resistor may be placed across the supply that will draw approximately 70 milliamperes at the operating potential of the screen. Screen voltage is not particularly critical, especially at plate potentials of 2500 volts and higher. However, the screen voltage should be adjusted for best linearity of the stage when the tube is operated at 2000 volts plate potential. A 350 volt, 150 ma. supply utilizing choke input and bled to 70 milliamperes, in conjunction with a 100 watt primary "Variac" or variable voltage transformer is a satisfactory source of screen voltage. Three VR-105 regulator tubes passing 40 ma. may be employed for a fixed-voltage screen supply.

Amplifier Construction Layout of the amplifier may be seen in figures 42, 44, 45, 46, and 47. A 12 $\frac{1}{4}$ " x 19" rack panel is employed to form the front of an enclosure 14" deep. The enclosure is built of $\frac{1}{2}$ -inch aluminum angle stock and the top, sides and back are covered with perforated aluminum sheet. The bottom of the enclosure is formed from a solid sheet of aluminum. Only a very small chassis is required to mount the 4CX-1000A tube socket, filament transformer, and grid circuit components. A chassis measuring 6" x 3" x 14" with one end cut off is employed (figure 47). This chassis is mounted at one end of the enclosure and supports a small aluminum angle bracket holding the two pi-network capacitors. The band-switching plate tank inductor is mounted di-

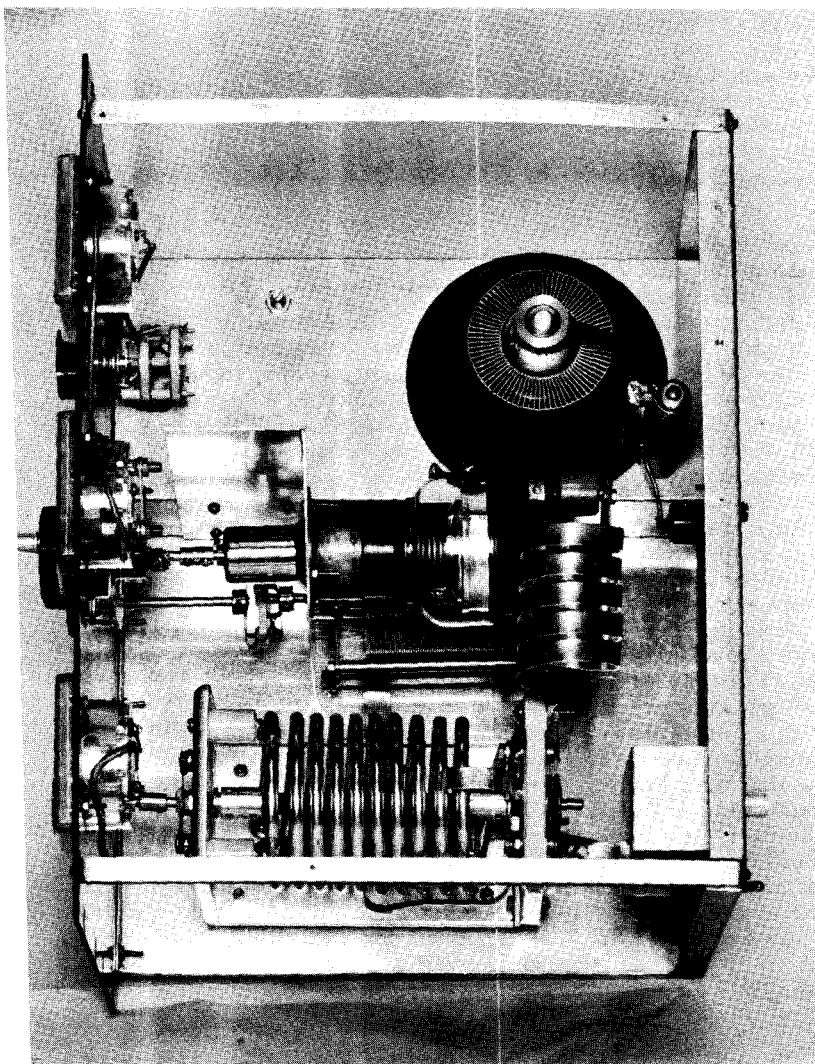

Figure 45
TOP VIEW OF
4CX-1000A
AMPLIFIER

Tetrad tube fits in Eimac air socket on small chassis at one end of enclosure. Pi-network capacitors are mounted on aluminum bracket attached to chassis, and are panel driven through flexible shaft couplers. Heavy duty, high-C band-switching inductor is at opposite side of assembly, with output circuit diode voltmeter mounted above it on rear of enclosure.

Extremely low harmonic content of amplifier removes need of meter shields. Amplifier may be run without enclosure with no sign of TVI on any band in normal TV signal area.

Figure 46
REAR VIEW OF CHASSIS ASSEMBLY

Air inlet, power receptacle and coaxial input jack are located on rear of amplifier chassis. Pi-network capacitor assembly is at left, with Raypar wideband plate r-f choke in foreground. Plate blocking capacitor is made of four 500 μmf . TV-type capacitors mounted in "sandwich" between stator plate of vacuum capacitor and round aluminum plate.

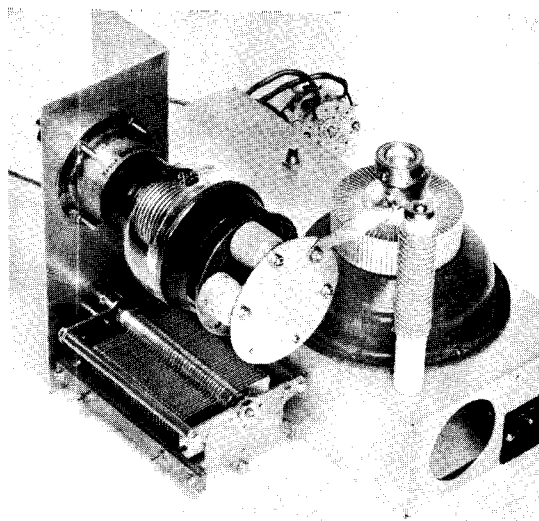

rectly to the aluminum bottom plate of the enclosure as seen in figure 45.

The low impedance plate tank circuit requires a higher than normal value of plate coupling capacitor. Four 500 μmf ., 20 KV TV-type capacitors are therefore mounted between two aluminum plates to form a 2000 μmf . "sandwich" which is bolted to the rear stator terminal of tuning capacitor C. The 10 meter inductor section of coil L bolts directly to the aluminum plate, as does the plate lead of the 4CX-1000A.

Special breechlock terminal surfaces are used on the tube in place of the conventional base. Three tabs protrude through the ceramic envelope for each tube element, providing a low inductance termination. The new *Eimac* SK-800 socket having a built-in screen bypass capacitor and an air vent should be employed with this tube.

The rated heater voltage for the 4CX-1000A is 6.0 volts and the operating voltage, as measured at the socket, should be maintained within plus or minus 5% of this value if long life operation is to be obtained. Note that the cathode and one side of the heater are internally connected.

Sufficient cooling must be provided for the anode and ceramic-to-metal seals to maintain operating temperatures below 200 degrees, Centigrade. At sea level, with an inlet air temperature of 20°C., a minimum of 35 cubic feet per minute of air flow is required. In this case, the chassis is pressurized and a 50 cubic foot/minute blower is connected to the air inlet on the rear of the chassis by means of a short length of automobile radiator hose. The cooling air must be maintained on the ceramic seals during standby periods when only heater voltage is applied to the tube.

Figure 47
UNDER-CHASSIS VIEW OF
4CX-1000A AMPLIFIER

Bias supply is placed at one end of chassis. Filament transformer is mounted next to air socket and short, heavy strap leads are used to eliminate voltage drop. Special air socket has built-in screen bypass capacitor to ensure low inductance ground path.

Amplifier Operation

Amplifier operating characteristics are given in figure 48. The bias potentiometer R_2 is adjusted to provide a zero-signal plate current of 250 milliamperes. At this value, the bias voltage will be approximately -55 volts. Resting plate current and screen voltage may both be varied over small limits to provide the greatest linearity range. Maximum single tone plate current is 1.0 ampere. Good linearity may be obtained at 2000 watts p.e.p. at a plate voltage of 2500 and maximum plate current of 800 ma.

Care should be taken not to apply excitation to the amplifier in the presence of screen voltage but with no plate voltage present. A relay interlock may be applied to the screen circuit to open it in the absence of plate voltage. Grid exciting voltage should be limited to about 60 volts, and grid current should be monitored to see that it does not exceed 0.5 milliamperes during tune-up.

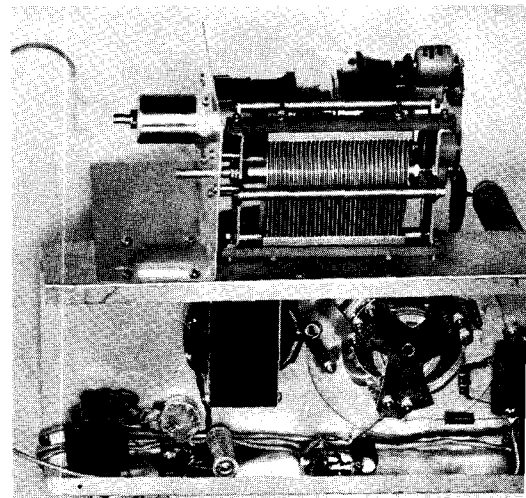

FIGURE 48
OPERATING CHARACTERISTICS, 4CX-1000A AMPLIFIER

PLATE VOLTAGE	2000	2500	3000
SCREEN VOLTAGE	325	325	325
GRID VOLTAGE	-55	-55	-55
ZERO SIGNAL: I_P (MA)	250	250	250
SINGLE TONE: I_P (MA)	1000	1000	900
ZERO SIGNAL: I_{G2} (MA)	-2	-2	-2
SINGLE TONE: I_{G2} (MA)	30	30	30
SINGLE TONE PEAK R-F GRID VOLTS	55	55	55
SINGLE TONE DRIVING POWER (WATTS)	0	0	0
SINGLE TONE POWER OUTPUT (WATTS)	1080	1460	1680

NOTE: ADJUST GRID VOLTAGE TO OBTAIN SPECIFIED ZERO-SIGNAL PLATE CURRENT.

29-11 A High Power Push-pull Tetrode Amplifier

The push-pull tetrode amplifier still retains a high degree of popularity in spite of the trend towards single-ended pi-network amplifiers. Regardless of the power level of the push-pull amplifier, the physical design must satisfy two important requirements. First, the plate and grid circuits of the amplifier must be symmetrical with respect to each tube; and second, the input and output circuits must be isolated from each other. Finally, after the physical layout of the amplifier has been de-

termined, steps must be taken to eliminate all tendencies towards parasitic oscillation.

Described in this section is a push-pull amplifier intended for operation in the 13 - 15 Mc. region. Push-pull 4-1000A tubes are employed, running at their maximum rated input. Other tubes, such as the 4-400A, 4-250A, or 4-125A may be substituted in the design, scaling down the various components to suitable sizes for the reduced power level. This amplifier design is suitable for use in the 3 - 30 Mc. frequency region. The lower limit of operation is restricted by the amount of tuning capacity in the grid and plate tank circuits. Padding capacitors placed across the variable tuning capacitors may be employed to reach the lower frequency portions of the HF spectrum. The upper frequency limit of operation is determined by the residual screen lead inductance of the particular tubes used in the circuit. At frequencies up to 30 Mc., no neutralizing difficulties are encountered with any of the previously mentioned tubes.

Circuit Description The complete schematic of the push-pull tetrode amplifier is shown in figure 50. Grid, filament, and auxiliary metering circuits of the amplifier are enclosed beneath the chassis in an "electrically tight" box. All leads leaving this box are suitably filtered to prevent leakage of energy into (or out of) the enclosure. The plate circuit of the amplifier is contained in a separate enclosure above the main chassis.

A small degree of feedback exists within the tetrode tubes due to the minute value of grid-plate capacity. It is therefore necessary to cross-neutralize the tubes by means of two capacitor tabs mounted near the envelope of the tube (figure 53). These capacitors are adjusted for minimum r-f feedback at the highest operating frequency of the amplifier.

Any tendency towards parasitic oscillation is eliminated by the use of small parasitic chokes placed in the grid and screen leads of each tetrode tube. Excellent parasitic suppression is achieved by strapping the screen ter-

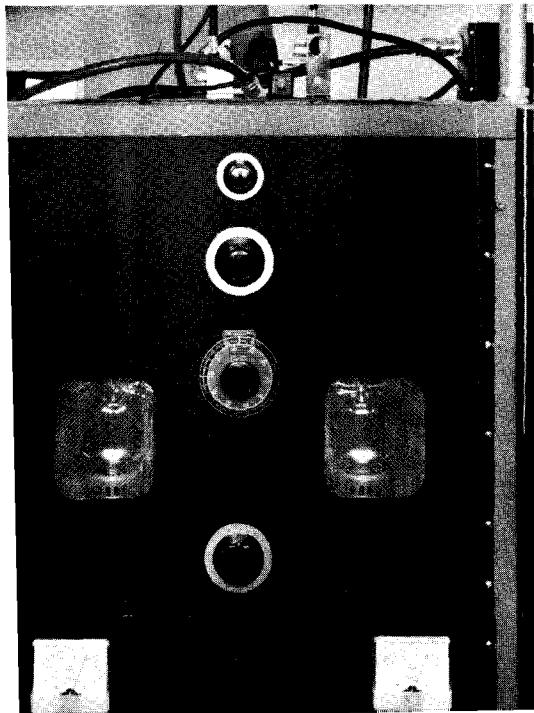

Figure 49
HIGH POWER PUSH-PULL AMPLIFIER
USES 4-1000A TUBES

This amplifier design is typical of push-pull stages regardless of power level. Tubes are visible through screened openings in panel. Controls are (top to bottom): Output link tuning, variable link coupling, plate circuit tuning, and grid circuit tuning. Amplifier is housed in special 21" rack. Filament meters for each tube are on auxiliary panel holding bias and screen supply.

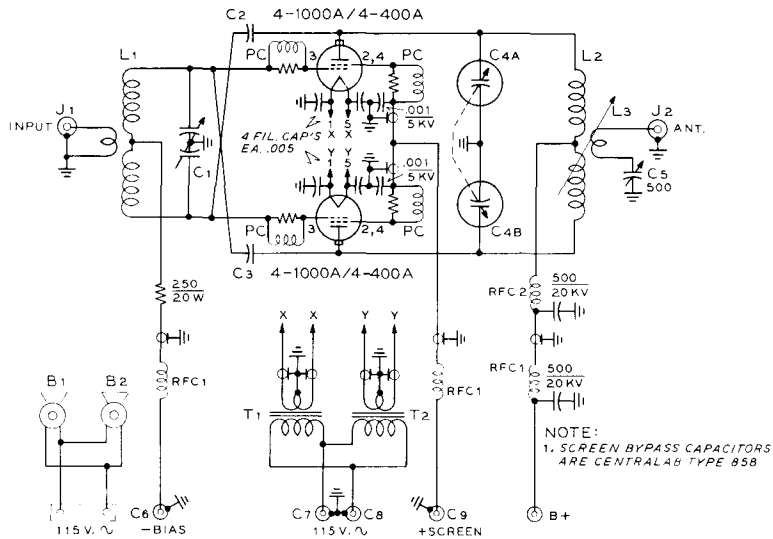

Figure 50
SCHEMATIC, PUSH-PULL HIGH POWER AMPLIFIER

- C₁—100 - 100 μ fd. "butter-fly" capacitor. Barker & Williamson type JCX
- C₂, C₃—Neutralizing capacitors. 1" x 3" aluminum plate mounted near tube envelope (figure 53)
- C_{1A-B}—60 - 60 μ fd. split-stator variable vacuum capacitor. Eimac VVC-60-20. See text for substitute
- C₄—500 μ fd. Johnson 500E20
- C₅—0.1 μ fd., 600 volt feedthrough capacitor. Centralab "HY-pass"
- RFC₁—VHF-type choke. National R-60, or Ohmite Z-50
- RFC₂—Heavy duty plate choke. Surplus choke from AN/ART-13 transmitter, or Barker & Williamson type 800
- PC—Parasitic suppressor. 3 turns #14 wire, 1/2-inch diam. in parallel with 47 ohm, 5 watt carbon "Globar" resistor

minals of the tetrode socket together (figure 52) and inserting a parasitic choke between the screen terminal of the socket and the screen bypass capacitor.

Eimac air sockets should be employed with the larger tubes, and a blast of air directed at the base seal of each tube is required. Two small 115-volt blower motors mounted on the rear of the chassis direct air streams through sections of radiator hose to the two tube sock-

Figure 51
REAR VIEW OF AMPLIFIER

Plate tank circuit is placed between tetrode tubes which are mounted in air sockets. Split-stator variable vacuum capacitor is panel mounted and rotors are grounded to chassis by heavy copper strap. Tank coil is mounted on 10" ceramic insulators. Individual filament transformers for the 4-1000A tubes are at rear of chassis. Each tube requires 7.5 volts at 21 amperes.

Swinging link is panel driven through Millen right-angle drive unit, and flexible, braided leads connect link to antenna resonating capacitor and coaxial receptacle mounted in top screen of amplifier.

Dual blower motor is mounted to rear of chassis. All power leads (including filament leads to meters) are brought out through bulkhead-type capacitors.

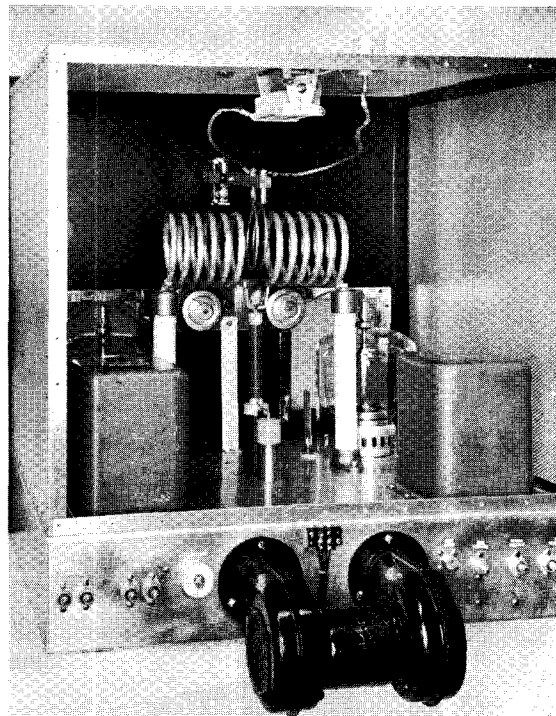

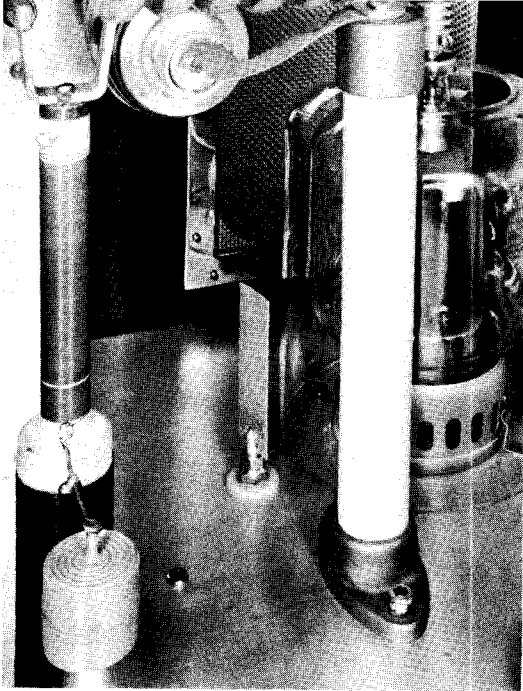

Figure 53
CLOSE-UP OF PLATE CHOKE AND
NEUTRALIZING CAPACITOR

Neutralizing capacitor is made of tab soldered to threaded rod mounted in insulating button affixed to chassis.

Amplifier Construction If 4-250A or 4-125A tubes are employed, a 15" x 17" x 6" chassis may be used. The 4-1000A tubes require a 17" x 19" x 6" chassis. Panel height is determined by the components mounted above the chassis deck. The top of the amplifier compartment should clear the plate coil by at least the diameter of the coil to prevent flash-over and to hold the coil Q to the highest possible value. The amplifier enclosure is made of 1/2-inch aluminum angle stock covered with perforated aluminum. The under-chassis area of the amplifier is sealed with a piece of solid aluminum sheet.

Plate circuit wiring is done with 1/2-inch silver plated copper strap, and for the higher power levels all connections in this circuit should either be bolted or silver-soldered. All grid circuit wiring is done with #10 copper wire, and all low voltage d.c. leads and a.c. wiring is done in shielded braid, the braid being grounded to the chassis at each end of the lead. A short length of RG-8/U coaxial line is used for the connection between the coaxial input plug and the link circuit of the grid coil.

The reactance of the antenna link is tuned out by means of a 500 μ fd. variable capacitor placed in the ground return of the link line. This capacitor is adjusted for maximum loading with the loosest possible degree of link coupling to the amplifier tank coil.

Amplifier Operation Excitation and grid bias are applied to the amplifier and a flashlight lamp is connected to the link output connections. The neutralizing tabs are varied in position with respect to the envelope of the tube after the grid and plate circuits have been tuned to resonance. Adjustments are made to the capacitors until the degree of feedback is reduced to a minimum.

Figure 52
UNDER-CHASSIS AREA OF
PUSH-PULL AMPLIFIER

Blower motors are connected to air sockets by short lengths of radiator hose. Filament leads are run in braid, grounded at each end. Shield plate is used over bottom of chassis to provide "electrically tight" enclosure. Screen terminals of each socket are strapped together, and choke PC attaches to center of strap.

ets. It is necessary to ground the metal base ring of each tube to the chassis, since this ring forms part of the screen shielding circuit. If grounding clips are not furnished with the tube socket, they may be made from a short length of 3/8-inch wide brass strap formed to spring against the base ring.

Excellent circuit symmetry is achieved by the use of "butter-fly"-type tuning capacitors in the grid and plate circuits. A 100-watt plug-in coil may be employed in the grid circuit, while heavy-duty plug-in coils will suffice in the plate circuit up to the kilowatt level.

If extremely high plate voltage is to be used, the *Eimac* dual vacuum variable capacitor (VVC-60-20) should be employed to prevent flash-over. The less expensive *Barker & Williamson* "butter-fly" capacitor may be employed for plate voltages of 3500 or less.

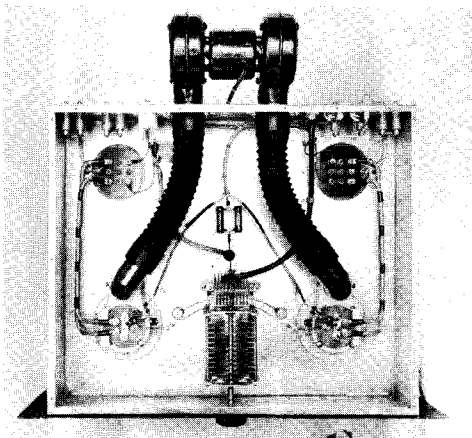

Speech and Amplitude Modulation Equipment

Amplitude modulation of the output of a transmitter for radiotelephony may be accomplished either at the plate circuit of the final amplifier, commonly called high-level AM or simply plate modulation of the final stage, or it may be accomplished at a lower level. Low-level modulation is accompanied by a plate-circuit efficiency in the final stage of 30 to 45 per cent, while the efficiency obtainable with high-level AM is about twice as great, running from 60 to 80 per cent. Intermediate values of efficiency may be obtained by a combination of low-level and high-level modulation; cathode modulation of the final stage is a common way of obtaining combined low-level and high-level modulation.

High-level AM is characterized by a requirement for an amount of audio power approximately equal to one-half the d-c input to the plate circuit of the final stage. Low-level modulation, as for example grid-bias modulation of the final stage, requires only a few watts of audio power for a medium power transmitter and 10 to 15 watts for modulation of a stage with one kilowatt input. Cathode modulation of a stage normally is accomplished with an audio power capability of about 20 per cent of the d-c input to the final stage. A detailed discussion of the relative advantages of the different methods for accomplishing amplitude modulation of the output of a transmitter is given in an earlier chapter.

Two trends may be noted in the design of systems for obtaining high-level AM of the final stage of amateur transmitters. The first is toward the use of tetrodes in the output stage of the high-power audio amplifier which is used as the modulator for a transmitter. The second trend is toward the use of a *high-level splatter suppressor* in the high-voltage circuit between the secondary of the modulation transformer and the plate circuit of the modulated stage.

30-1 Modulation

Tetrode Modulators

In regard to the use of tetrodes, the advantages of these tubes have long been noted for use in modulators having from 10 to 100 watts output. The 6V6, 6L6, and 807 tubes have served well in providing audio power outputs in this range. Recently the higher power tetrodes such as the 4-65A, 813, 4-125A, and 4-250A have come into more general use as high-level audio amplifiers. The beam tetrodes offer the advantages of low driving power (even down to zero driving power for many applications) as compared to the moderate driving power requirements of the usual triode tubes having equivalent power-output capabilities.

On the other hand, beam tetrode tubes require both a screen-voltage power supply and a grid-bias source. So it still is expedient in many cases to use zero-bias triodes or even

low- μ triodes such as the 304TL in many modulators for the medium-power and high-power range. A list of suggested modulator combinations for a range of power output capabilities is given in conjunction with several of the modulators to be described.

Increasing the Effective Modulation Percentage

It has long been known that the effective modulation percentage of a transmitter carrying unaltered speech waves was necessarily limited to a rather low value by the frequent high-amplitude peaks which occur in a speech waveform. Many methods for increasing the effective modulation percentage in terms of the peak modulation percentage have been suggested in various publications and subsequently tried in the field by the amateur fraternity. Two of the first methods suggested were *Automatic Modulation Control* and *Volume Compression*. Both these methods were given extensive trials by operating amateurs; the systems do give a degree of improvement as evidenced by the fact that such arrangements still are used in many amateur stations. But these systems fall far short of the optimum because there is no essential modification of the speech waveform. Some method of actually modifying the speech waveform to improve the ratio of peak amplitude to average amplitude must be used before significant improvement is obtained.

It has been proven that the most serious effect on the radiated signal accompanying overmodulation is the strong spurious-sideband radiation which accompanies negative-peak clipping. Modulation in excess of 100 per cent in the positive direction is accompanied by no undesirable effects as far as the radiated signal is concerned, at least so long as the linear modulation capability of the final amplifier is not exceeded. So the problem becomes mainly one of constructing a modulator-final amplifier combination such that negative-peak clipping (modulation in excess of 100 per cent in a negative direction) cannot normally take place regardless of any reasonable speech input level.

Asymmetrical Speech

The speech waveform of the normal male voice is characterized, as was stated before, by high-amplitude peaks of short duration. But it is also a significant characteristic of this wave that these high-amplitude peaks are poled in one direction with respect to the average amplitude of the wave. This is the "lopsided" or

asymmetrical speech which has been discussed and illustrated in an earlier chapter.

The simplest method of attaining a high average level of modulation without negative peak clipping may be had merely by insuring that these high-amplitude peaks always are poled in a positive direction at the secondary of the modulation transformer. This adjustment may be achieved in the following manner: Couple a cathode-ray oscilloscope to the output of the transmitter in such a manner that the carrier and its modulation envelope may be viewed on the scope. Speak into the microphone and note whether the sharp peaks of modulation are poled upward or whether these peaks tend to cut the baseline with the "bright spot" in the center of the trace which denotes negative-peak clipping. If it is not obvious whether or not the existing polarity is correct, reverse the polarity of the modulating signal and again look at the envelope. Since a push-pull modulator almost invariably is used, the easiest way of reversing signal polarity is to reverse either the leads which go to the grids or the leads to the plates of the modulator tubes.

When the correct adjustment of signal polarity is obtained through the above procedure, it is necessarily correct only for the specific microphone which was used while making the tests. The substitution of another microphone may make it necessary that the polarity be reversed, since the new microphone may be connected internally in the opposite polarity to that of the original one.

Low-Level Speech Clipping

The low-level speech clipper is, in the ideal case, a very neat method for obtaining an improved ratio of average-to-peak amplitude. Such systems, used in conjunction with a voice-frequency filter, can give a very worthwhile improvement in the effective modulation percentage. But in the normal amateur transmitter their operation is often less than ideal. The excessive phase shift between the low-level clipper and the plate circuit of the final amplifier in the normal transmitter results in a severe alteration in the square-wave output of the clipper-filter which results from a high degree of clipping. The square-wave output of the clipper ends up essentially as a double saw-tooth wave by the time this wave reaches the plate of the modulated amplifier. The net result of the rather complex action of the clipper, filter, and the phase shift in the succeeding stages is that the low-level speech clipper system *does* provide an improvement

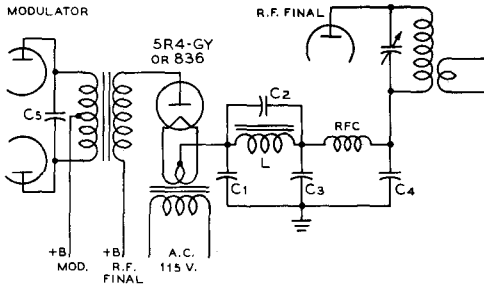

Figure 1

HIGH-LEVEL SPLATTER SUPPRESSOR

The high-vacuum diode acts as a series limiter to suppress negative-peak clipping in the modulated r-f amplifier as a result of large amplitude negative-peak modulating signals. In addition, the low-pass filter following the diode suppresses the transients which result from the peak-clipping action of the diode. Further, the filter attenuates all harmonics generated within the modulator system whose frequency lies above the cut-off frequency of the filter. The use of an appropriate value of capacitor, determined experimentally as discussed in Chapter Fifteen, across the primary of the modulation transformer (C_5) introduces further attenuation to high-frequency modulator harmonics. Chokes suitable for use at L are manufactured by Chicago Transformer Corp.. The correct values of capacitance for C_1 , C_2 , C_3 , and C_4 are specified on the installation sheet for the splatter suppressor chokes for a wide variety of operating conditions.

in the effective modulation percentage, but it does not insure against overmodulation. An extensive discussion of these factors, along with representative waveforms, is given in Chapter Fifteen. Circuits for some recommended clipper-filter systems will also be found in the same chapter.

High-Level Splatter Suppressor

One practicable method for the substantial elimination of negative-peak clipping in a high-level AM transmitter is the so-called *high-level splatter suppressor*. As figure 1 shows it is only necessary to add a high-vacuum rectifier tube socket, a filament transformer and a simple low-pass filter to an existing modulator-final amplifier combination to provide high-level suppression.

The tube, V_1 , serves to act as a switch to cut off the circuit from the high-voltage power supply to the plate circuit of the final amplifier as soon as the peak a-c voltage across the secondary of the modulation transformer has become equal and opposite to the d-c voltage being applied to the plate of the final amplifier stage. A single-section low-pass filter serves to filter out the high-frequency components resulting from the clipping action.

Tube V_1 may be a receiver rectifier with a 5-volt filament for any but the highest power transmitters. The 5Y3-GT is good for 125 ma. plate current to the final stage, the 5R4-GY and the 5U4-G are satisfactory for up to 250 ma. For high-power high-voltage transmitters the best tube is the high-vacuum transmitting tube type 836. This tube is equivalent in shape, filament requirements, and average-current capabilities to the 866A. However, it is a vacuum rectifier and utilizes a large-size heater-type dual cathode requiring a warm-up time of at least 40 seconds before current should be passed. The tube is rated at an average current of 250 ma. For greater current drain by the final amplifier, two or more 836 tubes may be placed in parallel.

The filament transformer for the cathode of the splatter-suppressor tube must be insulated



Figure 2
TOP VIEW OF THE
6L6 MODULATOR

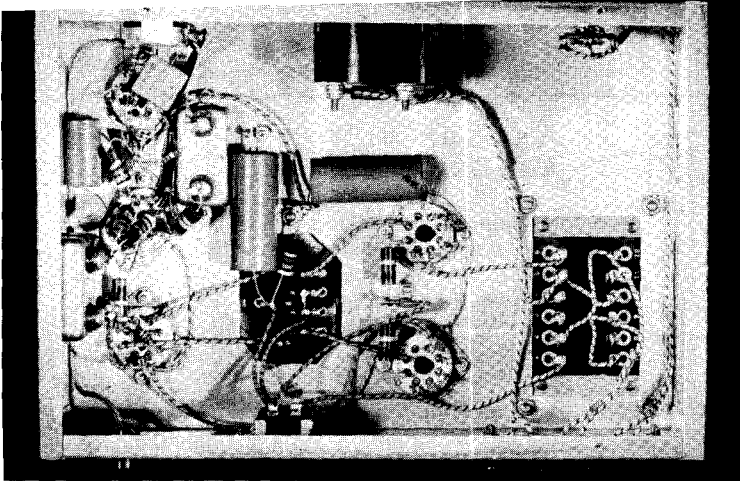

Figure 3
UNDERCHASSIS
OF THE
6L6 MODULATOR

A 4-connector plug is used for filaments and plate voltage for the speech amplifier, while a 6-wire terminal strip is used for the high-voltage connections and the transmitter-control switch.

for somewhat more than twice the operating d-c voltage on the plate modulated stage, to allow for a factor of safety on modulation peaks. A filament transformer of the type normally used with high-voltage rectifier tubes will be suitable for such an application.

30-2 Design of Speech Amplifiers and Modulators

A number of representative designs for speech amplifiers and modulators is given in this chapter. Still other designs are included in the descriptions of other items of equipment in other chapters. However, those persons who wish to design a speech amplifier or modulator to meet their particular needs are referred to Chapter Six, *Vacuum Tube Amplifiers*, for a detailed discussion of the factors involved in

the design of such amplifiers, and for tabular material on recommended operating conditions for voltage and power amplifiers.

10 to 120 Watt Modulator with Beam Power Tubes

It is difficult to surpass the capabilities of the reliable beam power tube when an audio power output of 10 to 120 watts is required of a modulator. A pair of 6L6 tubes operating in such a modulator will deliver good plate circuit efficiency, require only a very small amount of driving power, and they impose no serious grid-bias problems.

Circuit Description

Included on the chassis of the modulator shown in figures 2 and 3 are the speech amplifier, the driver and modulation transformers for the

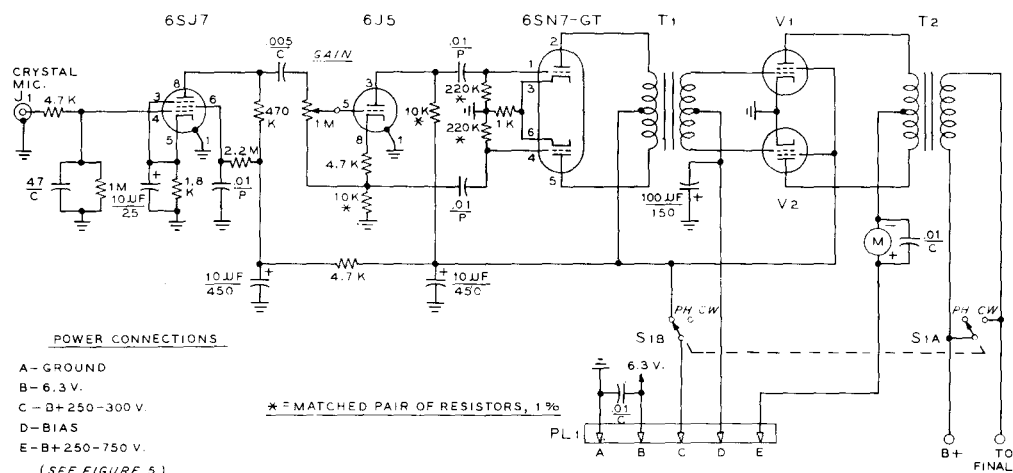

Figure 4
SCHEMATIC OF BEAM POWER TUBE MODULATOR

M—0 - 250 d.c. millimeter

T₁—Driver transformer. Stancor A-4701, or UTC S-10.

T₂—"Poly-pedance" Modulation transformer
60-watt level = Stancor A-3893, or UTC S-20
125-watt level = Stancor A-3894

output tubes, and a plate current milliammeter. The power supply has not been included. The 6SJ7 pentode first stage is coupled through the volume control to the grid of a 6J5 phase inverter. The output of the phase inverter is capacitively coupled to the grids of a 6SN7-GT which acts as a push-pull driver for the output tubes. Transformer coupling is used between the driver stage and the grids of the output tubes so that the output stage may be operated either as a class AB₁ or class AB₂ amplifier.

The Output Stage Either 6L6, 6L6-G or 807 tubes may be used in the output stage of the modulator. As a matter of fact, either 6V6-GT or 6F6-G tubes could be used in the output stage if somewhat less power output is required. The 807 tube is the transmitting-tube counterpart of the 6L6 and carries the same ratings and recommended operating conditions as the 6L6 within the ratings of the 6L6. But the 807 does have somewhat greater maximum ratings when the tube is to be used for ICAS (Intermittent Commercial and Amateur Service) operation. The 6L6 and 807 retail to the amateur for essentially the same price, although the 807 is available only from transmitting tube distributors. The 6L6-G tube retails for a somewhat lower price; hence it is expedient to purchase 6L6-G tubes if 360 to 400 volts is the maximum to be used on the output stage, or 807 tubes if up to 750 volts will be applied.

Tabulated in figure 5 are a group of recommended operating conditions for different tube types in the output stage of the modulator. In certain sets of operating conditions the tubes will be operated class AB₁, that is with in-

FIGURE 5
RECOMMENDED OPERATING CONDITIONS FOR MODULATOR OF FIG. 4 FOR DIFFERENT TUBE TYPES

TUBES V1, V2	CLASS	PLATE VOLTS (E)	SCREEN VOLTS (C)	GRID BIAS (D)	PLATE-TO-PLATE LOAD (OHMS)	PLATE CURRENT (MA.)	POWER OUTPUT (WATTS)
6V6GT	AB ₁	250	250	-15	10,000	70-80	10
6V6GT	AB ₁	285	285	-19	8,000	70-95	15
6L6	AB ₁	360	270	-23	6,600	85-135	27
6L6	AB ₂	360	270	-23	3,800	85-205	47
807	AB ₁	600	300	-34	10,000	35-140	56
807	AB ₁	750	300	-35	12,000	30-140	75
807	AB ₂	750	300	-35	7,300	30-240	120

creased plate current with signal but with no grid current. Other operating conditions specify class AB₂ operation, in which the plate current increases with signal and grid current flows on signal peaks. Either type of operation is satisfactory for communication work.

30-3 General Purpose Triode Class B Modulator

High level class B modulators with power output in the 125 to 500 watt level usually make use of triodes such as the 809, 811, 8005, 805, or 810 tubes with operating plate voltages between 750 and 2000. Figures 6, 7, and 8 illustrate a general purpose modulator unit designed for operation in this power range. Figure 8 gives a group of suggested operating conditions for various tubes. The size of the modulation transformer will of course be dependent upon the amount of audio power developed by the modulator. In the case

Figure 6
REAR VIEW OF THE
GENERAL-PURPOSE MODULATOR

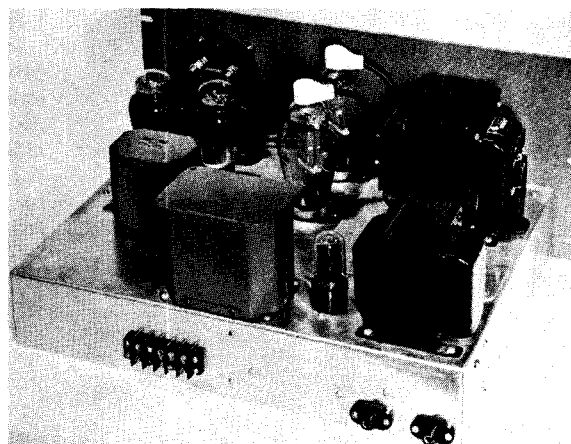

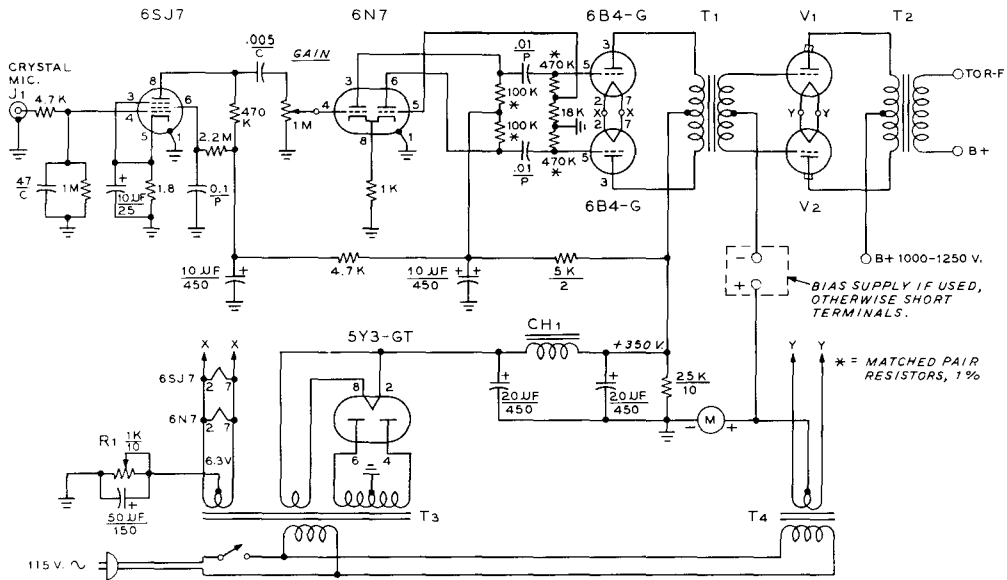

Figure 7
SCHEMATIC OF GENERAL PURPOSE MODULATOR

M—0 - 500 ma.
T₁—Driver transformer. Stancor A-4761
T₂—"Poly-pedance" Modulation transformer.
 300 watt rating, Stancor A-3898.
 500 watt rating, Stancor A-3899.
T₃—360 - 0 - 360 volts, 150 ma. Stancor PC-8410

T₄—Suitable for tubes used.
 For 811-A's = 6.3 volt, 8 amp. Stancor P-6308
 For 810's = 10 volt, 10 amp. Stancor P-6461
CH₁—14 henry, 100 ma. UTC S-19. Stancor C-1001
R₁—1 K, 10 watts, adjustable. Set for plate current
 of 80 ma. (no signal) to 6B4-G tubes
 (approximately 875 ohms).
V₁, V₂—See figure 8.

of the 500 watt modulator (figures 9 and 10) the size and weight of the components require that the speech amplifier be mounted on a separate chassis. For power levels of 300 watts or less it is possible to mount the complete speech system on one chassis.

Circuit Description of General Purpose Modulator

The modulator unit shown in figure 6 is complete except for the high voltage supply required by the modulator tubes. A speech amplifier suitable for operation with a crystal microphone is included on the chassis along with its own power supply. A 6SJ7 is used as a high gain preamplifier stage resistance coupled to a 6N7 phase inverter. The audio level is controlled by a potentiometer in the input grid circuit of the 6N7 stage. Push-pull 6B4-G low μ triodes serve as the class B driver stage. The 6B4's are coupled to the grids of the modulator tubes through a conventional multi-purpose driver transformer. Cathode bias is employed on the driver stage which is capable of providing 12 watts of audio power for the grid circuit of the modulator.

The modulator illustrated in figures 9 and 10 is designed for use with class B 810 triode tubes operating at a plate potential of 2500 volts. Maximum audio power available is 500 watts, sufficient to 100% modulate a transmitter running one kw. input. The modulator may be driven by the simple speech amplifier of figure 12, or by the clipper-amplifier of figure 15.

FIGURE 8
SUGGESTED OPERATING CONDITIONS FOR GENERAL PURPOSE MODULATOR

TUBES V ₁ , V ₂	PLATE VOLTAGE	GRID BIAS (VOLTS)	PLATE CURRENT (MA.)	PLATE TO PLATE LOAD (OHMS)	SINE WAVE POWER OUTPUT (WATTS)
809	700	0	70-250	6,200	120
811-A	750	0	30-350	5,100	175
811-A	1000	0	45-350	7,400	245
811-A	1250	0	50-350	9,200	310
811-A	1500	-4.5	32-315	12,400	340
805	1250	0	148-400	6,700	300
805	1500	-16	84-400	8,200	370
810	2000	-50	60-420	12,000	450
810	2500	-75	50-420	17,500	500
8005	1500	-67	40-330	9,800	330

Figure 9
REAR VIEW OF 810
500-WATT CLASS B
MODULATOR
Bias control is directly be-
low the 810 tubes with bias
supply to right.

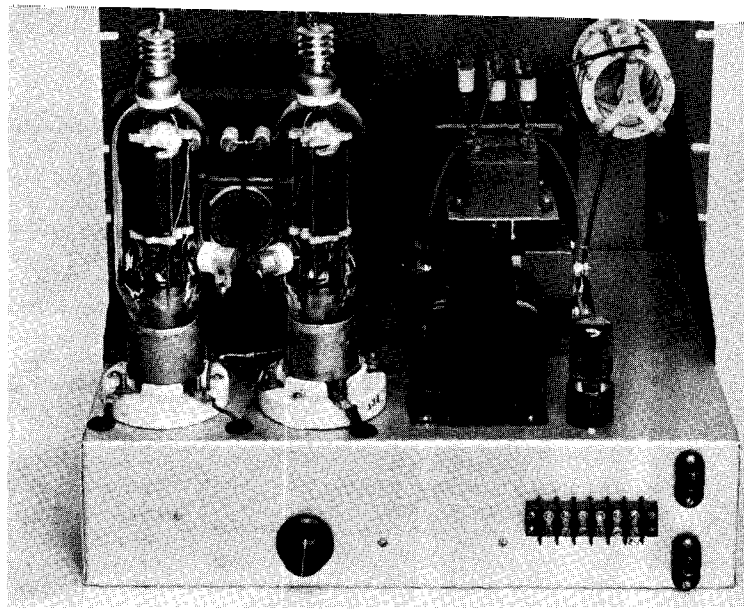

The modulator chassis includes a small low impedance bias supply capable of delivering approximately —75 volts under the changing load conditions imposed by the varying grid circuit impedance of the class B modulator.

A low pass audio filter network is placed after the modulator stage to reduce harmonics

generated in the audio system which would normally show up as side-band "splatter" on the phone signal. Frequencies above 3500 cycles are attenuated 15 decibels or more by the simple pi-network filter shown in figure 10.

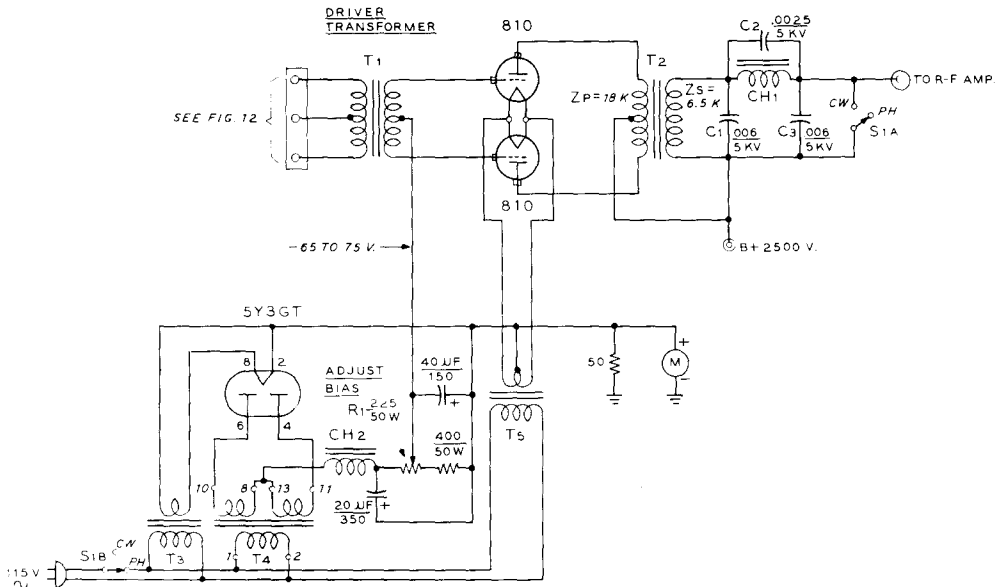

Figure 10

SCHEMATIC OF 500 WATT TRIODE MODULATOR WITH BIAS SUPPLY

- T₁*—Driver transformer, 15 watts. Stancor A-4761
- T₂*—Modulation transformer, 500 watt. Chicago Transformer Co. CMS-3
- T₃*—5 volts, 3 amp. Stancor P-6467
- T₄*—Tapped bias transformer, 15-100 volts. UTC S-51
- T₅*—10 volt, 10 amp. Stancor P-6461
- CH₁*—500 ma. "splatter choke" Chicago Transformer Co. SR-500
- CH₂*—7 henry, 150 ma. Stancor C-1710
- M*—0 - 500 d.c. milliammeter
- S1A*—High voltage switch (see text)

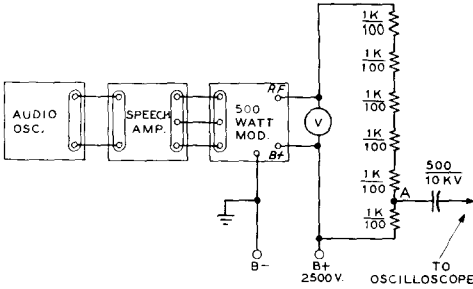

Figure 11
TEST SETUP FOR 500-WATT
MODULATOR

For c-w operation the secondary of the class B modulation transformer is shorted out and the filament and bias circuits of the modulator are disabled. Switch S_{1A} must have 10,000 volt insulation rating. A suitable switch may be found in the war surplus BC-306A antenna loading unit.

All low voltage connections to the modulator are brought out to a six terminal phenolic strip on the back of the chassis. A 0-500 ma. d-c meter is placed in the filament circuit of the 810 tubes. The meter is placed across a 50 ohm, 1 watt resistor so that the filament return circuit of the modulator is not broken if the meter is removed.

The modulation transformer, T_2 , is designed for plate-to-plate loads of either 12,000 ohms or 18,000 ohms when a 6250 ohm load is placed across the secondary terminals. The 810 tubes are correctly matched when the 18,000 ohm taps are used at a plate potential of 2500 volts, or when the 12,000 ohm taps are used at a plate potential of 2000 volts or 2250 volts.

Modulator Construction Because of the great weight of the modulator components it is best to use a heavy-duty steel chassis. A 13" x 17" x 4" chassis (*Bud CB-643*), a 14" steel panel (*Bud PS-1257G*) and a pair of *Bud MB-449* mounting brackets make up the assembly for this particular modulator. As seen in figure 9, the CMS-3 modulation transformer is mounted in the left-front corner of the unit. The secondary terminals of T_2 are to the front of the chassis, clearing the front panel by about $\frac{1}{2}$ ". To the right of T_2 is placed the high level audio filter choke, CH_1 . The two 810 tubes are mounted in back of T_2 . To the right of the 810 tubes is the 10 volt filament transformer, T_3 . To the right of T_3 is the 5Y3-GT bias rectifier tube. Between T_3 and CH_1 are mounted the mica bypass capaci-

tors which make up the high level filter network. Two .003 μ fd., 5000 volt mica capacitors are paralleled for C_1 and also for C_2 . C_2 is made from a .001 μ fd. capacitor and a .0015 μ fd. capacitor which are connected in parallel. All of these capacitors are mounted upon a plywood bracket which insulates them from the metal chassis. This prevents insulation breakdown within the capacitors which might occur if they were fastened directly to the metal chassis.

The bias supply components are mounted beneath the four-inch deep chassis. Placement of these parts is not critical. The bias adjustment control, R_1 , is mounted on the back lip of the chassis as are the two high voltage terminals. *Millen 37001* high voltage connectors are used for the two high voltage leads. High-voltage TV wire should be employed for all leads in the 810 plate circuit.

Modulator Adjustment When the modulator has been wired and checked, it should be tested before being used with an r-f unit. A satisfactory test set-up is shown in figure 11. A common ground lead should be run between the speech amplifier and the modulator. Six 1000 ohm 100 watt resistors should be connected in series and placed across the high voltage terminals of the modulator unit to act as an audio load. The first step is to place the 810 tubes in their sockets and turn switch S_1 to the "phone" position. The 810 filaments should light, and switch section S_{1A} should remove the short across the secondary of T_2 . R_1 should be adjusted to show -75 volts from each 810 grid terminal to ground as measured with a high resistance voltmeter. If an oscilloscope is available, it should be coupled to point "A" on the load resistor (figure 11) through a 500 μ fd. ceramic TV capacitor of 10,000 volts rating. The case of the oscilloscope should be grounded to the common ground point of the modulator.

A plate potential of 2500 volts is now applied to the modulator, and R_1 adjusted for a resting plate current of 50 milliamperes as read on the 500 milliampere meter in the cathode circuit of the modulator. *Be extremely careful during these adjustments, since the plate supply of the modulator is a lethal weapon. Never touch the modulator when the plate voltage supply is on! Be sure you employ the TV blocking capacitor between the oscilloscope and the plate load resistors, as these load resistors are at high voltage potential! If a high resistance a-c voltmeter is available that has a 2000 volt scale, it should be clipped*

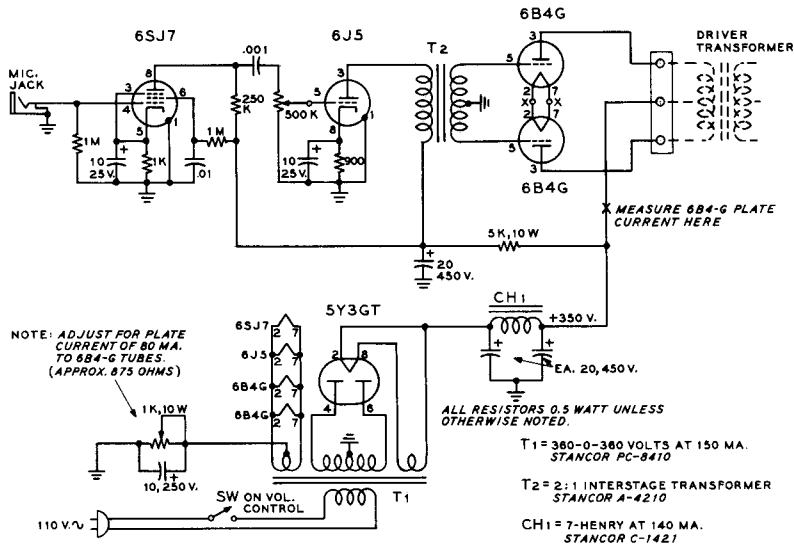

Figure 12
10-WATT SPEECH AMPLIFIER-DRIVER

between the high voltage terminals of the modulator, directly across the dummy load. Do not touch the meter when the high voltage supply is in operation! An audio oscillator should be connected to the audio input circuit of the exciter-transmitter and the audio excitation to the high level modulator should be increased until the a-c voltmeter across the dummy load resistor indicates an R-M-S reading that is equal to 0.7 (70%) of the plate voltage applied to the modulator. If the modulator plate voltage is 2500 volts, the a-c meter should indicate 1750 volts developed across the 6000 ohm dummy load resistor. This is equivalent to an audio output of 500 watts. With sine wave modulation at 1000 c.p.s. and no speech clipping ahead of the modulator, this voltage should be developed at a cathode meter current of about 350 ma. when the plate-to-plate modulator impedance of the modulator is 18,000 ohms. Under these conditions, the oscilloscope may be used to observe the audio waveform of the modulator when coupled to point "A" through the 10,000 volt coupling capacitor.

When the frequency of the audio oscillator is advanced above 3500 cycles the output level of the modulator as measured on the a-c voltmeter should drop sharply indicating that the low pass audio network is functioning properly.

With speech waveforms and no clipping the modulator meter will swing to approximately 150 - 200 milliamperes under 100% modulation

at a plate potential of 2500 volts. With speech waveforms and moderate clipping the modulator meter will swing to about 300 ma. under 100% modulation.

30-4 A 10-Watt Amplifier - Driver

A simple speech amplifier-driver for a medium powered class B modulator is shown in figure 12. The amplifier is designed to work with a crystal microphone. The first stage utilizes a 6SJ7. The gain control is between the 6SJ7 plate circuit and the grid of the 6J5 second stage amplifier. The output tubes are a pair of 6B4-G low-mu tubes operating with a self-bias resistor in their common filament return circuit. Operating in this manner the 6B4's have an undistorted output of approximately 10 watts. This is sufficient power to drive most class-B modulators whose output is 500 watts or less. The driver transformer for coupling the plates of the 6B4-G tubes to the grids of the Class B stage is not shown, as it had been found more convenient to locate this transformer at the grids of the modulator tubes rather than in the speech amplifier. The correct transformer step-down ratio for driving most class B tubes has been set down in tabular form by the various transformer manufacturers. When the driver transformer is purchased one should be obtained which has the proper turns ratio for the class B tubes to be used.

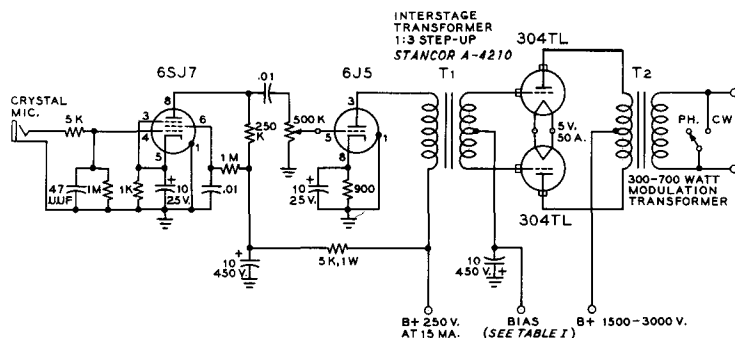

Figure 13
PUSH-PULL 304TL CLASS AB₁, MODULATOR

A three wire shielded cable should be used to connect the 6B4-G tubes to the driver transformer located at the grids of the class B tubes. This cable may be any reasonable length up to 25 or 30 feet. Any of the modulator configurations shown in figure 8 may be driven with this simple speech amplifier.

30-5 500-Watt 304TL Modulator

Ordinarily, few amateurs would be inclined to design the high-level stages of their transmitters around type 304TL tubes. Although the 304TL unquestionably is an excellent tube, with its extremely high transconductance and power sensitivity, its price and capabilities are in excess of those required even for a kilowatt amateur transmitter. But with enormous supplies of these tubes available at a relatively low price on the surplus market it becomes economical to consider their use in high-power

amateur transmitters. In fact, with the use of these 304TL's the cost of heating power for filaments becomes a much more significant figure than the cost of the tubes.

The 304TL is ideally suited for use as a modulator for a high-power amateur transmitter. In fact, due to the relatively low amplification factor of the tube (about 12) the 304TL may even be used as a class A triode Heising modulator. Such an arrangement is practicable for modulating a medium-power transmitter when a 1500 to 2000 volt plate supply is available.

The class AB₁ operating characteristics of the 304TL tube are shown in figure 14. An interesting fact to be observed is that under these conditions no grid driving power is required by the 304TL tubes. It is necessary only to supply the correct amount of grid driving voltage. The amounts shown may easily be obtained from a single 6J5 tube, and the usual push-pull triode driver stage for the high powered modulator may be eliminated. A suitable modulator-driver unit which will deliver 500 watts of audio from two 304TL tubes operating class AB₁ is shown in figure 13.

The filaments of the 304TL tubes may be connected either in series or parallel for either 5 volt, 50 ampere operation, or 10 volt, 25 ampere operation. To conserve filament power during standby periods, the filaments of the 304TL tubes may be either turned off, or may be dropped to one-half voltage by means of a dropping resistor in the primary circuit of the filament transformer. This resistor may be shorted out during periods of transmission by a small relay actuated by the transmitting control system.

The gain of the speech amplifier is sufficient so that an inexpensive crystal microphone may be used with the modulator. The

TABLE I

304TL OPERATING CHARACTERISTICS, CLASS AB ₁ (NO DRIVING POWER REQUIRED)				
D.C. PLATE VOLTS	1500	2000	2500	3000
GRID BIAS *	-118	-170	-230	-290
ZERO-SIGNAL PLATE CURRENT (MA.)	270	200	180	130
MAX. SIGNAL PLATE CURRENT (MA.) **	572	546	483	444
PLATE-TO-PLATE LOAD (OHMS)	2540	5300	8500	12000
PEAK A.F. GRID VOLTS (PER TUBE)	118	170	230	290
MAX. POWER OUTPUT (WATTS)	256	490	610	730

* ADJUST TO GIVE STATED ZERO-SIGNAL PLATE CURRENT

** VALUES GIVEN FOR SINE-WAVE MODULATION, FOR VOICE WAVE FORMS, MAXIMUM CURRENT WILL BE APPROXIMATELY TWO-THIRDS SINE-WAVE VALUES.

Figure 14

Those resistors in the 12AU7 phase inverter plate circuit and the grid circuit of the 6B4-G tubes should be matched to achieve best phase inverter balance. The exact value of the paired resistors is not important, but care should be taken that the values are equal. Random resistors may be matched on an ohmmeter to find two units that are alike in value. When these matched resistors are soldered in the circuit, care should be taken that the heat of the soldering iron does not cause the resistors to shift value. The resistors should be held firmly by the lead to be soldered with a long nose pliers, which will act as a heat-sink between the soldered joint and the body of the resistor. If this precaution is taken the two phase inverter outputs will be in close balance.

Adjustment of the Speech Amplifier

When the wiring of the speech amplifier has been completed and checked, the unit is ready to be tested.

Before the tubes are plugged in the amplifier, the bias supply should be energized and the voltage across the 600 ohm bleeder resistor should be measured. It should be -68 volts. If it is not, slight changes in the value of the series resistor, R_3 , should be made until the correct voltage appears across the bleeder resistor. The tubes may now be inserted in the amplifier and the positive and cathode voltages checked in accordance with the measurements given in figure 15. After the unit has been

tested and is connected with the modulator, R_2 should be set so that it is impossible to over-modulate the transmitter regardless of the setting of R_1 . The gain control (R_1) may then be adjusted to provide the desired level of clipping consistent with the setting of R_2 .

30-7 A 200-Watt 811-A De-luxe Modulator

One of the most popular medium power r-f amplifier stages consists of a single tetrode tube, such as the 4-125A, 813, or 7094 operating at a plate potential of 1200 - 1700 volts and a plate current of 150 - 275 milliamperes. Such an amplifier requires a minimum of r-f driving power, allows an input of 300 to 400 watts, and yet employs power supply components that are relatively modest in cost. The 5-db signal increase between a 300 watt transmitter and a 1000 watt transmitter is very expensive when one considers the additional cost of modulator and power supply equipment.

Additional economy may be achieved if the modulator and final amplifier are operated from the same power supply. The new series of *Chicago-Standard* plate transformers provide voltage ranges in the 1000 to 1500 volt region and are well suited for the combination of this modulator and the aforementioned r-f tubes. Within this voltage range, the 811-A triode is an excellent choice for the modulator tubes. Zero bias operation may be had up to

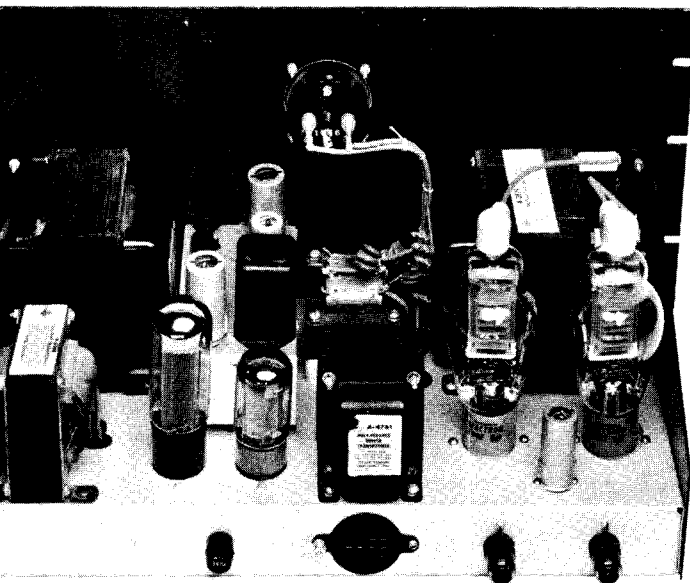

Figure 16
REAR VIEW OF
811-A MODULATOR

Modulator tubes and voltage regulator are at right with high level filter at center of chassis. Plug-in speech amplifier is to left of clipper. Gain and clipping controls are atop the small chassis. 6L6/5881 is used as cathode follower driver stage for modulator.

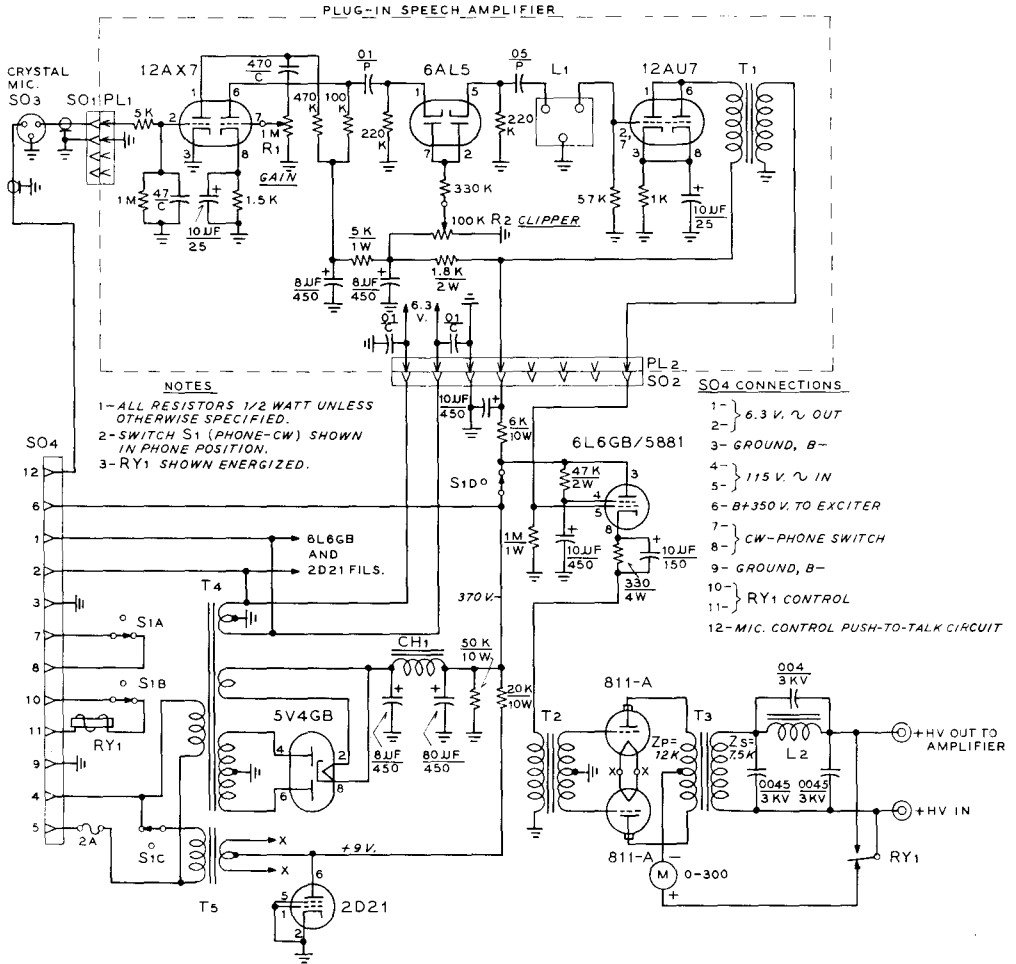

Figure 17
SCHEMATIC, 200 WATT 811-A MODULATOR

- T₁—1:3 Interstage Transformer. Stancor A-53
- T₂—"Poly-pedance" class B driver transformer. 2:1 ratio. Stancor A-4761
- T₃—200 watt modulation transformer. 9 K primary. 5K secondary. Stancor A-3829
- T₄—400 - 0 - 400 volts, 250 ma., 6.3 volts, 5 amperes. Stancor PC-8413
- T₅—6.3 volts, 10 amperes. Stancor P-6308
- CH₁—4 henry, 250 ma. Stancor C-1412
- L₁—Low pass filter, 3000 cycle cut off. Chicago LPF-2.
- L₂—"Splatter" filter, 300 ma. Stancor C-2317
- RY₁—SPDT relay, high voltage insulation, 115 volt coil. Leach #1723 with 374 coils, or equivalent

1250 volts, and only -4.5 volts is required for 1500 volt operation. Bias voltage may be obtained from flashlight batteries or other low impedance source.

Modulator Circuit The 200 watt de-luxe modulator is illustrated in figures 16 and 18 and the schematic is given in figure 17. The low level audio stages are similar to those of the speech amplifier shown in Section Six. A 12AX7 is employed as two

stages of R-C amplification driving a 6AL5 speech clipper tube. A 3500 cycle low pass filter follows the clipper, removing all high order products of clipping action. A parallel-connected 12AU7 follows the filter and is transformer-coupled to a 5881 (6L6-GB) cathode follower driver stage. The impedance of the cathode circuit of the driver stage is extremely low; it provides an excellent driving source for the class B modulator grid circuit.

Two 811-A tubes are employed in the class B stage. When operated at 1000 volts, no bias supply is needed. At voltages of 1200 or above, approximately 9 volts of bias is required. This is supplied by a voltage divider composed of a 20K, 10 watt resistor and a 2D21 thyratron tube. When the miniature 2D21 is connected as a triode, it acts as a voltage regulator tube with a constant voltage drop of almost 9 volts from plate to cathode. The tube will regulate over 300 milliamperes of current while maintaining a reasonably constant voltage drop across its terminals. The center tap of the 811-A filament transformer (T_s) is thus held at a positive potential with respect to ground. Since the center tap of the 811-A driver transformer (T_r) is grounded, the modulator tubes are biased at a constant negative voltage equal

to the voltage drop across the 2D21 regulator tube in the cathode circuit of the class B stage.

The plate to plate load impedance of the 811-A tubes when operating at 1500 volts is approximately 12,000 ohms. A multi-match type modulation transformer may be employed if desired, but in this case a *Stancor A-3829* unit was used. This transformer is designed to match the plate-to-plate load impedance of 9,000 ohms to a secondary load of 5000 ohms. With the 12,000 ohm load of the 811-A tubes, a secondary load of 7,500 ohms must be used to maintain the same primary to secondary impedance ratio. This secondary load can be obtained with a single 7094 tube operating at 1500 volts and 200 milliamperes of plate current (300 watts input). Other tubes and load impedances can also be used, providing the r-f input to the modulated stage does not exceed 400 watts. For example, a 4-125A tube operating at 2000 volts and 165 ma. (330 watts) may be modulated by this audio unit. The secondary winding of the modulation transformer can pass a maximum of 300 milliamperes with safety.

The audio output from the 811-A stage is passed through a high level low-pass "splatter suppressor" which attenuates all audio frequencies above 3500 cycles. The use of both low level and high level audio filters does much to reduce the broad sidebands and co-channel interference that seems to be so common on the amateur phone bands.

A high voltage relay RY_1 is employed to short the secondary of the modulation transformer and remove plate potential from the modulator tubes for c-w operation. The relay is actuated by the "phone-c.w." switch on the front panel of the modulator. Other segments of this switch turn off the modulator filaments and provide extra contacts to control auxiliary equipment.

A 350 volt supply is incorporated in the modulator unit to power the speech amplifier and driver stage and to provide power for the r-f exciter stages of the transmitter. The various power and control leads are brought out to a multi-connector plug mounted on the rear of the modulator deck.

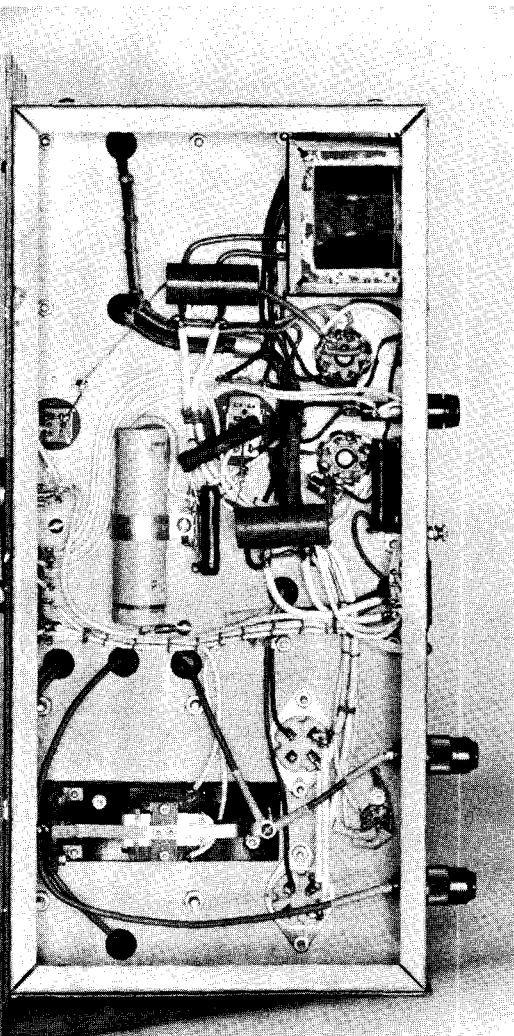

Figure 18
UNDER-CHASSIS VIEW OF
811-A MODULATOR

High voltage relay is between 811-A tube sockets, and low voltage components are at opposite end of chassis.

Modulator Construction The modulator is constructed upon a steel chassis measuring 8" x 17" x 2". A 10½" aluminum panel is bolted to the chassis with two mounting brackets to form a rugged assembly. Placement of the major parts may be seen in figures 16 and 18. The modulation transformer T_3 and the 811-A tubes occupy the right end of the chassis, balanced in weight by the power transformer T_4 and modulator filament transformer T_5 at the opposite end of the chassis. The center space is taken by the plug-in speech amplifier, the high level splatter filter assembly and the 5881 driver stage.

The speech amplifier is constructed as a separate unit on a small aluminum utility box measuring 5" x 3" x 2". The bottom of the box holds two male plugs which match two receptacles mounted on the amplifier chassis. The speech amplifier, therefore, may be wired and tested as a separate unit. Clipping and audio level controls are mounted atop the amplifier box as long usage of clipper circuits has proven that these controls need not be re-adjusted once they are properly set.

The phone-c.w. switch, relay RY-1 and various small components are mounted beneath the chassis (figure 18). The input receptacle for the speech amplifier box is located adjacent to the microphone receptacle on the front panel of the modulator making the interconnecting lead less than two inches long. Also placed beneath the chassis are the filter choke for the low voltage supply and the various bypass and filter capacitors.

Wiring and Testing the Modulator The speech amplifier should be wired first.

The small resistors and capacitors are mounted either between the tube socket pins, or between terminals of small phenolic tie-point strips. Transformer T_1 is fastened within the amplifier box and is wired in the circuit after all other wiring is completed. Plugs PL₁ and PL₂ are mounted on the bottom portion of the box; the plug pins are wired to the proper points of the speech amplifier with short lengths of wire that allow the bottom plate to be removed for inspection and testing without the necessity of unsoldering any connections to the plugs.

The modulator chassis should be wired next. All leads to T_3 , RY-1, and the low pass filter should be carefully insulated from the chassis. High voltage "5000 volt test" cable should be employed for these connections. The capacitors that make up the high level audio filter are mounted directly to the terminals of the

filter choke which is mounted above the chassis on ½-inch ceramic insulators. High voltage connections to the modulator are made through *Millen 37001* safety terminals.

When the wiring has been completed and checked, the 12AX7, 6AL5, 12AU7, 5881, and 5V4-GB tubes should be inserted in their sockets and the speech amplifier is plugged into the modulator receptacles. The vertical amplifier of an oscilloscope should be connected to one grid terminal of the 811-A stage. Plate voltage of the 5881 should be approximately 370 volts. A low level 1000 cycle tone (approximately 0.05 volts, r.m.s.) is applied to the amplifier input. The output level of the speech amplifier is controlled by the setting of the clipping control R_2 and the audio gain is controlled by potentiometer R_1 in the grid circuit of the 12AX7. The clipping control should be set so that not more than 60 volts r.m.s. is developed from one 811-A grid to ground. The modulator tubes may now be plugged in their sockets. A 7K, 200 watt resistor should be placed between the "H.V. Out" and "H.V. In" terminals, serving as a dummy load, and 1500 volts applied to the latter terminal. With no audio signal the resting plate current of the modulator stage should be approximately 15 milliamperes, kicking up to about 160 milliamperes under full output conditions. Final adjustment of the clipping control may be made when the modulator is placed in use with the r-f section of the transmitter. Potentiometer R_2 is then adjusted to limit the peak modulation level under sine wave modulation to approximately 90%.

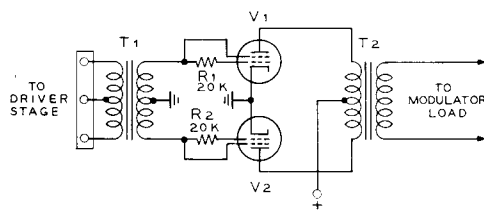

Figure 19

ZERO BIAS TETRODE MODULATOR ELIMINATES SCREEN AND BIAS SUPPLIES

Low driving power and simplicity are key features of this novel modulator. Tubes ranging in size from 6AQ5's to 813's may be employed in this circuit.

T_1 —Class B driver transformer

T_2 —Modulation transformer

V_1, V_2 —6AQ5, 6L6, 807, 803, 813, etc.

R_1, R_2 —Not used with 803 and 813



Despite the fact that complete transmitters may be purchased at moderate cost many amateurs still prefer to build their station equipment. The experience gained in constructing such equipment cannot be duplicated by any other means.

Shown in this chapter are two complete phone and c.w. transmitters that are well suited as "building projects" for the advanced amateur who has had experience building other equipment. The transmitter designs are unique in that equipment of this type and power rating is not readily available on the commercial market. The first transmitter covers the 50 Mc. and 144 Mc. VHF bands and is capable of 300 watts input (phone) and 450 watts input (c.w.). The second transmitter covers the 3.5 Mc.—29.7 Mc. amateur bands and runs 375 watts input (phone) and 500 watts input (c.w.). Both transmitters are complete, including modulators and power supplies and are system-designed for ease of operation and reliability. The cost of either unit is quite low, considering the power level involved.

31-1 A 300 Watt Phone/C-W Transmitter for 50/144 Mc.

Transmitters operating in the VHF region present some specialized design problems that must be solved before reliable, efficient operation can be obtained. The first problem concerns the relative inefficiency of tuned and coupled circuits in this region. The amount of r-f power that can be lost in simple circuits is extremely high unless special pains are taken in the design and layout of the VHF stages. Radiation loss, skin effect, dielectric losses, lead inductance, distributed capacity, and parasitic ground returns all exist at the lower frequencies, but only in the higher portion of the spectrum do their effects assume such vital importance, and only at these frequencies does their cure and elimination become so essential. As a result, the necessity for close correlation between the electrical design and the mechanical properties of the VHF circuit cannot be overemphasized.



Figure 1
COMPACT
300 WATT
TRANSMITTER FOR
SIX AND TWO
METERS IS IDEAL
FOR VHF
ENTHUSIAST

The transmitter is built in two sections. Upper deck contains VFO, r.f. stages and push-pull 826 amplifier. VFO tuning dial is at right, with bandswitch and meter selector switch below it. At center are the multiplier tuning controls, with buffer and final amplifier tuning controls at the left.

Lower deck holds modulator and power supply. Transmitter control switches are along lower edge of the panel.

The second problem concerns the vacuum tube. A combination of factors is at work in the common tube which tend to limit the efficiency of the tube as the frequency of operation is raised. Inter-electrode capacitance, lead inductance, transit time, and input circuit loading are some of the factors that cripple vacuum tube performance in the VHF region. The drop in tube operation efficiency shows up in the form of plate dissipation. Reducing the size of the vacuum tube to combat the various operational problems reduces its power handling capability, since only small element areas are then present for heat dissipation.

Tetrode vs. Triode The combination of inter-electrode capacitance and lead inductance in the simple tetrode tube produce a phenomenon called *self-neutralization*. At some one particular frequency in or near the VHF region the tetrode tube is inherently self-neutralized due to the circuit elements within the tube structure and the external inductance of the screen-to-ground path. Below this frequency normal neutralizing procedures apply; but above this frequency special neutralizing circuits are required. These circuits are usually frequency sensitive. The self-neutralizing frequency of the less expensive screen grid tubes usually falls between 20 - 50 Mc., requiring that the tubes be re-neutralized when the frequency of operation is changed from 50 Mc. to 144 Mc., and often when the operating frequency is moved about within one of these bands. The newer external anode tetrodes are free of this problem as their self-neutralization frequency falls well above the 144 Mc. amateur band.

The triode tube, on the other hand, has no frequency of self-neutralization. The maximum frequency at which neutralization is effective is dependent upon the inductance of the tube leads, the electron transit time, and the inter-electrode capacitance. Rather than a point in the spectrum at which the neutralization problems abruptly change, the neutralization point of the triode tube merely grows more obscure as the operating frequency is raised, until above a certain frequency neutralization is no longer possible. Fortunately, small, compact, inexpensive triode tubes exist that are capable of efficient operation well into the VHF region, and two tubes of this general type are employed in this transmitter. Special circuits are also used to ensure that the tubes remain in neutralization over the operating range.

Transmitter Circuitry A block diagram of the r-f circuitry is shown in figure 2. The transmitter is divided into two sections. The exciter section (V_1 - V_4) delivers about ten watts of power over the frequency ranges of 50 - 54 Mc. and 144 - 148 Mc. A 5763 is employed either as a crystal controlled oscillator or as a variable frequency oscillator, operating in the 8 - 9 Mc. region. Two separate oscillator tuned circuits are employed as the tuning rates for the two bands are different. The "2 meter" VFO covers the range of 8.0 - 8.222 Mc., and the "6 meter" VFO tunes 8.333 - 9.0 Mc. The tuning capacitors of the two circuits are ganged for tuning ease. Tubes V_2 and V_3 multiply the overall VFO range to the 48 - 54 Mc. spectrum. At this point a simple switching system permits V_3 to drive either the intermediate amplifier

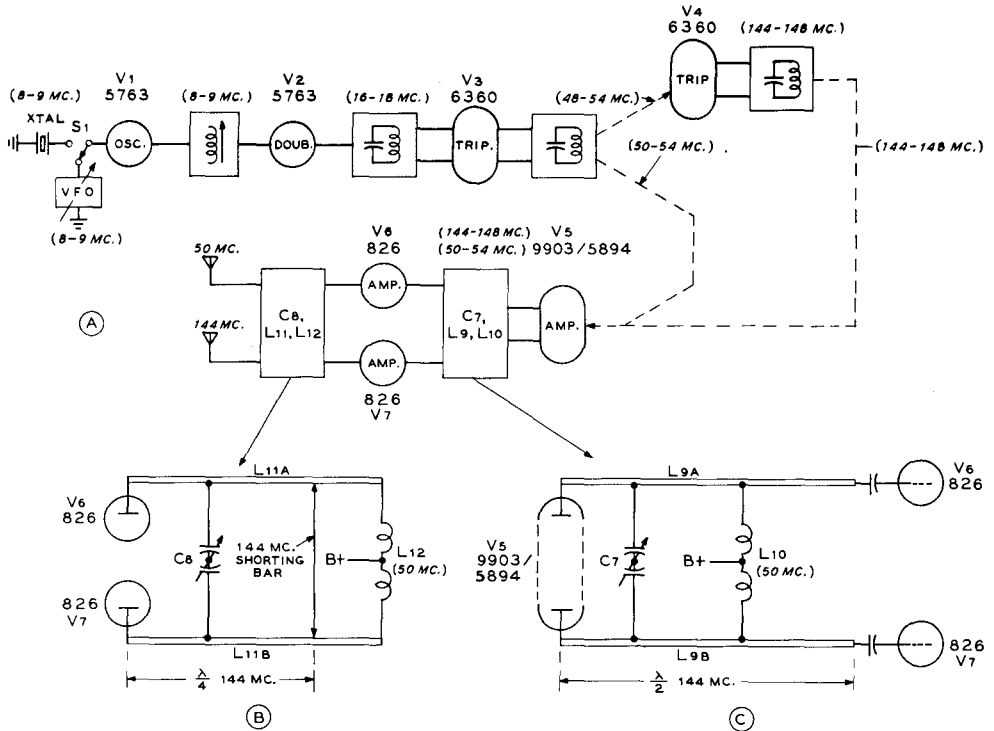

Figure 2
BLOCK DIAGRAM OF VHF TRANSMITTER

- A—General transmitter circuit, showing operating frequencies of the various stages. V_4 is a plug-in frequency multiplier.
- B—Quarter-wave tank circuit is employed in amplifier plate configuration at 144 Mc. Shorting bar is removed for 50 Mc., and C_6 - L_{12} resonates at this frequency.
- C—Linear half-wave tank section is employed as interstage coupler at 144 Mc. Inductor L_{10} resonates circuit to 50 Mc.

tube V_5 directly for 50-54 Mc. operation, or via a tripler stage (V_4) for 144-148 Mc. operation. A 9903/5894 (V_5) is employed as the driver stage for the push-pull triode final amplifier. This driver tube operates as a straight amplifier on both bands.

A unique coupling circuit, shown in figure 2C, is employed between the 9903/5894 and the push-pull 826 stage. The plates of the buffer and grids of the final stage are coupled to the ends of a loaded, half-wave 144 Mc. transmission line. The 50 Mc. coil is placed at the electrical center of the 144 Mc. line. Tuning capacitor C_7 is tapped on the line at a point which permits each circuit to be resonated. Thus the combination L_9 A-B, L_{10} , C_7 is capable of tuning the 2 meter and 6 meter ranges simultaneously, eliminating the need for plug-in coils or coil switching. Neutralization of the 9903/5894 is not required if adequate inter-stage shielding is used.

The power amplifier stage employs two type 826 tubes in push-pull. These compact triode tubes are well suited to VHF work as their lead inductance is small and their inter-electrode capacitance is reasonably low. The tubes have adequate plate dissipation and a high reserve of filament emission. The amplifier has been run at one kilowatt input (2000 volts at 500 milliamperes) for c.w. operation for extended periods of time without apparent damage to the tubes, but this practice is not recommended for maximum tube life.

A modified form of two band plate circuit is employed in the amplifier stage, as shown in figure 2B. A quarter-wave 144 Mc. transmission line is employed, tuned to frequency by "butter-fly" capacitor C_6 . The "cold" end of the line is shorted by a heavy strap which is removed for 50 Mc. operation. At the latter frequency, resonance is established by capacitor C_6 and coil L_{12} which is mounted at the

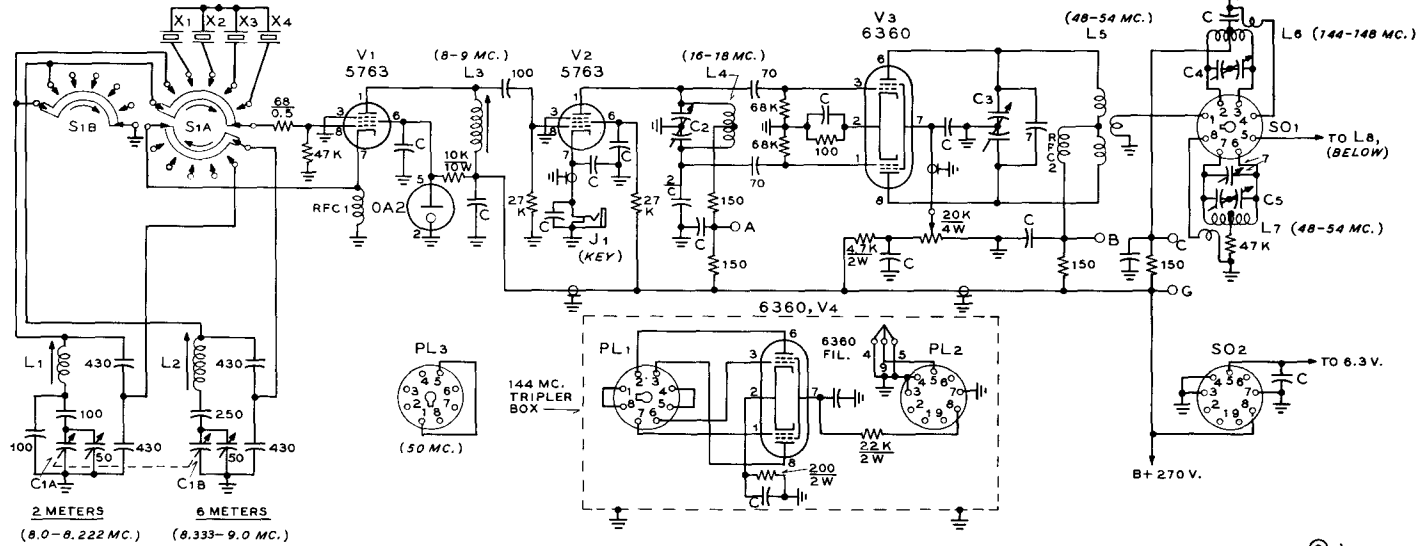

2 METERS (8.0-8.222 MC.)
 6 METERS (8.333-9.0 MC.)

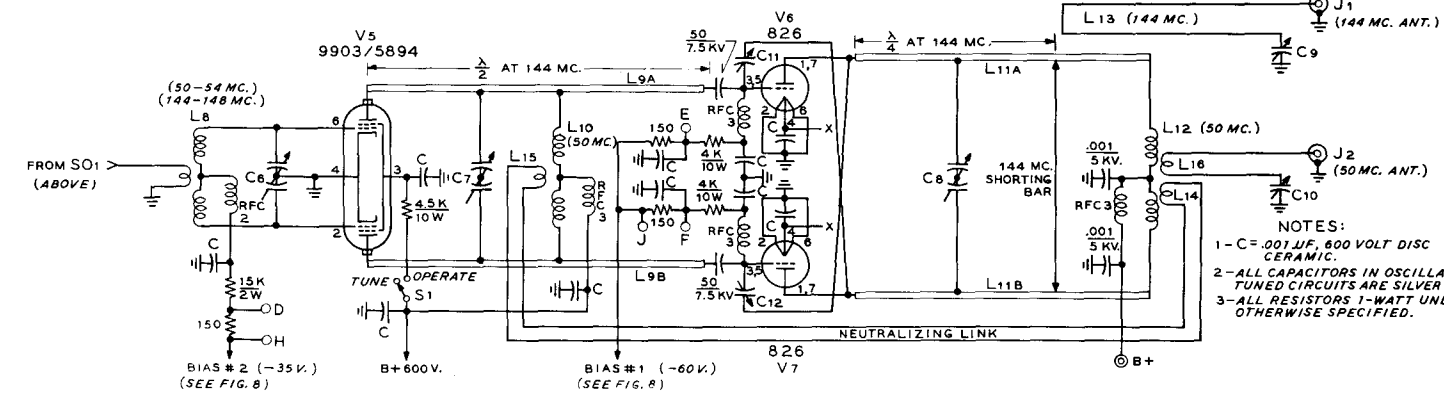

NOTES:
 1-C = .001 μ F, 600 VOLT DISC CERAMIC.
 2-ALL CAPACITORS IN OSCILLATOR TUNED CIRCUITS ARE SILVER MICA.
 3-ALL RESISTORS 1-WATT UNLESS OTHERWISE SPECIFIED.

Figure 3
 SCHEMATIC, R-F SECTION OF VHF TRANSMITTER

C_{1A-B}—25 - 25 μ fd. Bud LC-1661
 C₁, C₂—15 - 15 μ fd. Bud LC-1660
 C₃, C₄—8 - 8 μ fd. Bud LC-1659
 C₅—10 - 10 μ fd. "butterfly," Johnson 11MB11
 C₆—35 - 35 μ fd. Bud LC-1667
 C₇—25 - 25 μ fd. "butterfly," B&W JXC-25E, ie stator removed in each section

C₈—35 μ fd., .024" spacing. Bud LC-1872
 C₁₀—50 μ fd., .024" spacing. Bud LC-1873
 C₁₁, C₁₂—1 - 7 μ fd. See figure 13
 RFC₁—2.5 mh. National R-100
 RFC₂—Ohmite Z-50
 RFC₃—Ohmite Z-144

S_{1A-B}—2 deck, 3 pole, 6 position rotary ceramic switch.
 PL₁—Octal plug, Amphenol
 PL₂—Noval plug (9 pin) See text
 PL₃—Octal plug, Amphenol
 L₁-L₁₆—See figure 12, coil table
 X₁-X₄—8.0 - 9.0 Mc. crystals, type FT-243

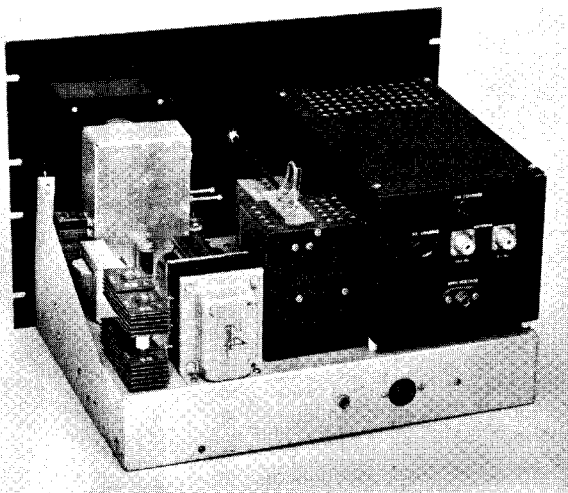

Figure 4

REAR VIEW OF VHF TRANSMITTER

Final amplifier compartment is at right with antenna receptacles and loading capacitors on rear of enclosure. Ventilation holes are drilled above 826 tubes to aid air circulation. Entire top should be replaced with perforated material if extended periods of operation are encountered. Buffer compartment is to left of large enclosure, with 9903/5894 tube mounted in inverted position. Grid coil (L_3 , see figure 7) plugs in holder at top of compartment. Grid tuning capacitor is panel driven by phenolic shaft extension. The 144 Mc. multiplier box is in position behind buffer compartment

Variable frequency oscillator is at left of chassis, with plug-in crystals mounted on the side. Oscillator tube V_1 can be seen in front of enclosure. Low voltage power supply components are in left corner of chassis.

B-plus end of the transmission line. The 144 Mc. linear lines (L_{1A-B}) serve merely as connections between the tubes and the coil at 50 Mc. An attempt was made to do away with the shorting bar, permitting the amplifier tank circuit to operate in the same manner as the buffer circuit which requires no component changes when the operating frequency is changed from band to band. It was found that the resulting drop in plate circuit efficiency was so high as to be unacceptable. Wing nuts are therefore provided to permit rapid removal of the shorting bar when 50 Mc. operation is desired.

Amplifier Neutralization Circuit

Because of electron transit time, and the combination of lead inductance and inter-electrode capacitance the us-

Figure 5 CLOSE-UP OF INTERIOR OF VHF FINAL AMPLIFIER

Two 826 triode tubes are used in unique push-pull circuit for 50 Mc. and 144 Mc. operation. Linear tank circuit is employed for 144 Mc. with removable shorting bar in foreground. "Butterfly" tuning capacitor is mounted on ceramic insulators above linear tank and connected to it by means of copper straps on rear stator terminals. 50 Mc. inductor is placed at "cold" end of 2-meter tank.

Air is drawn into enclosure through ventilation holes drilled below 826 sockets. Note that the sockets are split to reduce possibility of flash-over.

At left of enclosure are 6360 (V-3) and sockets SO-1 and SO-2 for 144 Mc. plug-in frequency multiplier. The 50 Mc. adapter PL-3 is in place. Oscillator tuning slugs are seen on right side of oscillator compartment at left. 50 Mc. coil is in place atop buffer compartment.

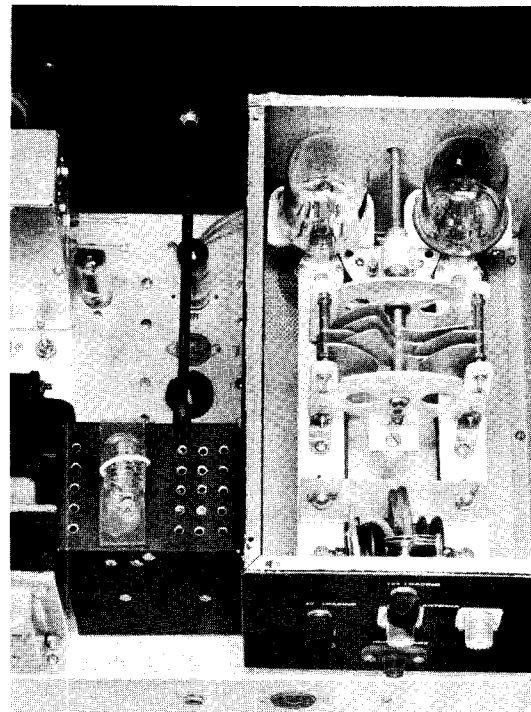

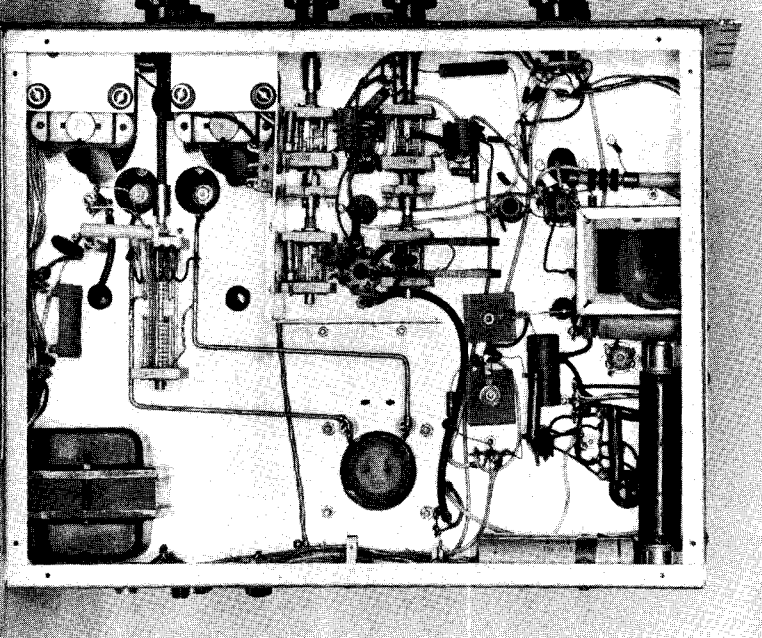

Figure 6
UNDER-CHASSIS
VIEW OF 300
WATT VHF
TRANSMITTER

Small 115-volt blower motors for 826 tubes are in upper left corner of chassis. Buffer plate line L_{5A-B} occupies left-hand portion of chassis. All leads are kept clear of this area. Under-chassis power leads are run in shielded braid to reduce r-f pick-up. An "L"-shaped shield partition isolates frequency doubler stages from buffer plate line. Capacitors C_2 and C_5 are ganged, as are capacitors C_3 and C_4 . Power supply components occupy lower right-hand corner of chassis.

The top of the 9903/-5894 buffer tube projects through hole at center of chassis.

Mc., and a simple link neutralization circuit ($L_{14}-L_{15}$) is employed to complete neutralization at 50 Mc. This double neutralization circuit results in absolute stability of operation on both bands. Since the 50 Mc. plate coil L_{12} is decoupled from the 144 Mc. tank circuit by the shorting bar, very little spurious coupling exists between the two neutralizing circuits and adjustments are simple and may be made once and then forgotten.

The Band-changing System

A frequency shift between 50 Mc. and 144 Mc. may be made in a matter of minutes. Switch S_1 selects the correct crystal or VFO range. The plate coil L_3 is broadly resonant over the 8-9 Mc. range and requires no adjustment after initial setting. The 5763 and 6360 plate circuits may be resonated to the correct frequency for either band without the necessity of coil changing. For 144 Mc. operation, however, it is necessary to remove the 50 Mc. plug, PL-3 (figure 7) and insert in its place the 144 Mc. tripler box (figure 3). In addition, grid coil L_8 of the 9903/5894 stage must be changed. The amplifier plate circuit shorting strap is removed for 144 Mc. Finally, the buffer and amplifier plate tank circuits must be resonated to frequency.

Separate antenna coupling systems are employed for each band. Two coupling loops are used, the 144 Mc. loop (L_{13}) is coupled to the quarter-wave tank circuit, and the 50 Mc. loop (L_{16}) is coupled to plate coil L_{12} .

Power Supply and Modulator

The low voltage supplies are located on the rear of the r-f deck, and are diagrammed in figure 8. A voltage doubler selenium supply provides 600 volts for the 9903/5894 stage and 270 volts for the exciter. A second selenium rectifier supply provides negative bias for the buffer and final amplifier stages. Isolating diodes D_6 and D_7 reduce interaction between the two bias voltages.

The high voltage plate supply and modulator are located on a separate deck. The supply provides 1500 volts at 500 ma. for the modulator and final amplifier stage. The modulator consists of a pair of 811-A tubes, operating

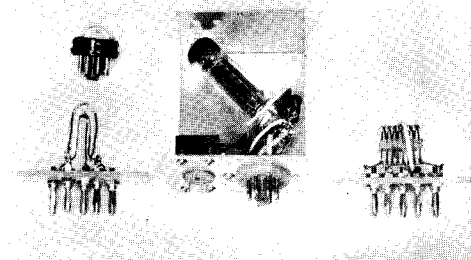

Figure 7
CLOSE UP OF
PLUG-IN
COMPONENTS

144 Mc. plug-in tripler box containing 6360 (V-4) is at center. Tube is mounted at angle on small plate with ventilation holes drilled in box above top of tube. 9-pin plug PL₃ is made from portion of a Vector socket. 50 Mc. plug PL₂ is at upper left, with 144 Mc. coil L_3 directly below it. 50 Mc. coil L_8 is at right. See figure 12 for coil data.

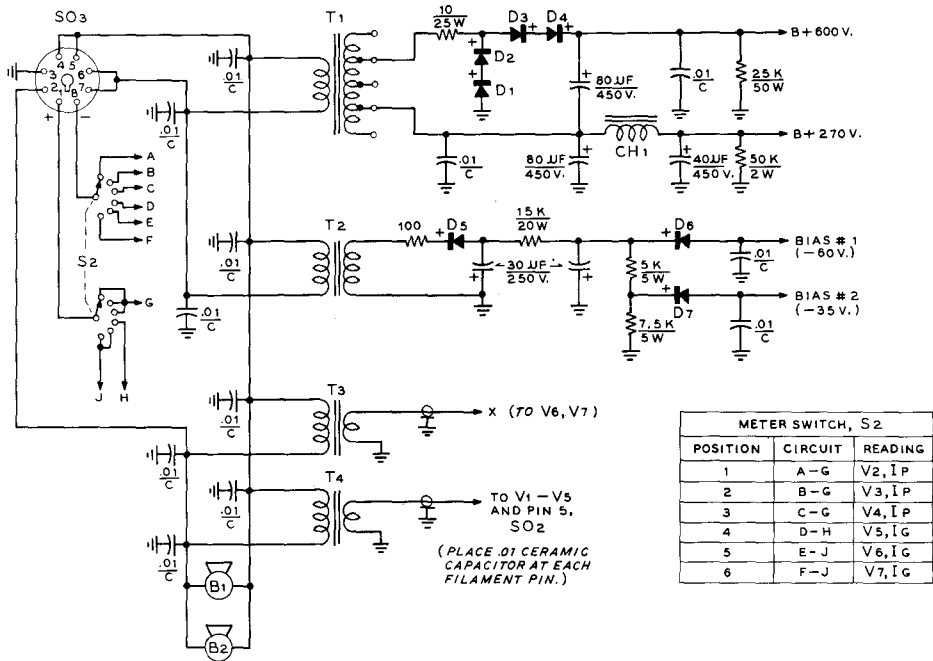

Figure 8

SCHEMATIC, LOW VOLTAGE SUPPLIES AND METER SWITCHING CIRCUIT

T₁—600/300 v., c.t., 360 ma. Use 300 volt taps for voltage doubler service. Triad P-3.

T₂—125 volts, 50 ma. Stancor PA-8421

T₃—7.5 volts, 8 a. Stancor P-6138

T₄—6.3 volts, 6 a. Stancor P-3036

D₁₋₄—Selenium rectifier, 100 ma., RMS input voltage: 175. Maximum peak inverse voltage: 495.

Sarkes-Tarzian Model 108

D₅₋₆—Selenium rectifier, 75 ma., RMS input voltage: 130. Sarkes-Tarzian Model 75

B₁, B₂—Small 115-volt blower motor.

S₂—2 pole, 6 position rotary switch.

SO₁—8 prong octal socket (see figures 3 and 10)

class B. Any one of the speech amplifiers shown in chapter 30 is suitable for use with the modulator. The complete schematic of this deck is shown in figure 10.

High voltage primary circuits are energized by relay RY₁ after the plate circuit control switch S₂ is closed. External relay control terminals are provided for auxiliary circuits.

Metering A 0-100 d.c. milliammeter (M₂, figure 10) is employed to monitor the low voltage circuitry. A six position switch (S₂, figure 8) places the meter across 150 ohm shunts in the plate and grid circuits as shown in the table of figure 8. Meter M₁ reads plate current of the modulator and final r-f amplifier. This meter is placed in a high potential circuit, and should have a bakelite case and an insulated zero-set control.

Transmitter Construction The overall layout of the r-f section can be seen in figures 4, 5, and 6. The foundation

consists of a 13" x 17" x 3" aluminum chassis firmly fastened to a 12¼" x 19" relay rack panel. The oscillator compartment (figure 9) measures 2" x 4" x 6". The grid circuit compartment for the 9903/5894 is 3" x 4" x 5" in size, and the plug-in 144 Mc. tripler box measures 2" x 3" x 3½". The push-pull 826 final amplifier is enclosed in an aluminum box measuring 6" x 7" x 12". This compartment is mounted clear of the chassis on ½-inch metal posts. Care must be taken to see that each corner of the box makes a good electrical ground with the chassis. The plug-in tripler box fits into two tube sockets (SO-1 and SO-2) placed in line with the extension shaft that drives buffer grid capacitor C₆. The special sockets with 50 Mc. plug PL-3 inserted in SO-1 can be seen in figure 5.

The 9903/5894 buffer socket is mounted to the "top" of the grid circuit compartment with the plate leads projecting out of matching holes cut in the "bottom" of the box and the chassis.

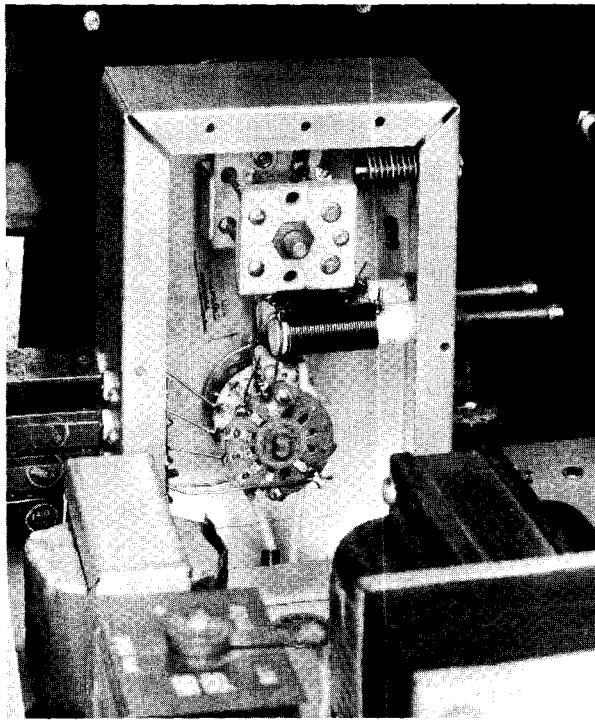

Figure 9
INTERIOR,
HIGH STABILITY
VFO FOR VHF
TRANSMITTER

Two gang oscillator tuning capacitor C.A-B is panel mounted at top of enclosure. Variable trimming capacitors are at the right, with slug-tuned coils directly below. Bandswitch S.A-B is placed at bottom of front panel, with crystal sockets at left. The two leads to oscillator tube socket pass through large rubber grommet mounted on chassis deck.

After alignment is completed, a drop of nail polish is placed on end of coil slug to eliminate mechanical vibration of slug. Note that rear of case is bolted in place with eight sheet metal screws to provide rigidity to enclosure. Oscillator tube socket is in foreground, partially hidden by selenium rectifier.

Ventilation holes are drilled in the top of this box, and grid coil L_s mounts in banana plugs mounted on a polystyrene plate atop the box.

Two 826 sockets are mounted at the front end of the amplifier box on metal spacers. Trouble occurred with the sockets flashing over on occasional modulation peaks. Accordingly, that portion of the socket holding the two plate pins was cut away and the pin connectors were bolted directly to the ends of the plate circuit straps, $L_{11}A$ and $L_{11}B$. The back of a hacksaw blade and cutting compound are used to cut grooves across the top and bottom surfaces of the socket. A sharp blow with a hammer will fracture the socket along the groove lines.

Ventilation holes are drilled in the box and chassis directly below the tubes and are covered with window screen to reduce spurious energy radiation through the openings.

The two $1\frac{1}{8}$ " wide aluminum straps that serve as the 144 Mc. tuned circuit are supported at the "B-plus" end on two solid ceramic insulators. Two more insulators of the same height serve to mount the "butter-fly" capacitor to the box. Small copper strips connect the tank straps to the stator terminals of the variable capacitor. The 50 Mc. coil and the re-

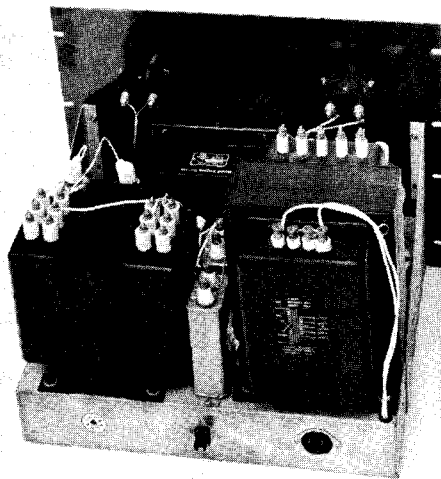

Figure 11
REAR VIEW,
POWER SUPPLY CHASSIS

Power supply is built upon steel chassis. Power transformer and modulation transformer are at rear of chassis. Three $4 \mu\text{fd.}$, 2KV filter capacitors are connected in parallel to provide adequate dynamic reserve. One capacitor is placed under the chassis. Insulated, high voltage terminal is employed for B-plus lead. Rectifiers are at right, front of chassis, with modulator tubes at left-front.

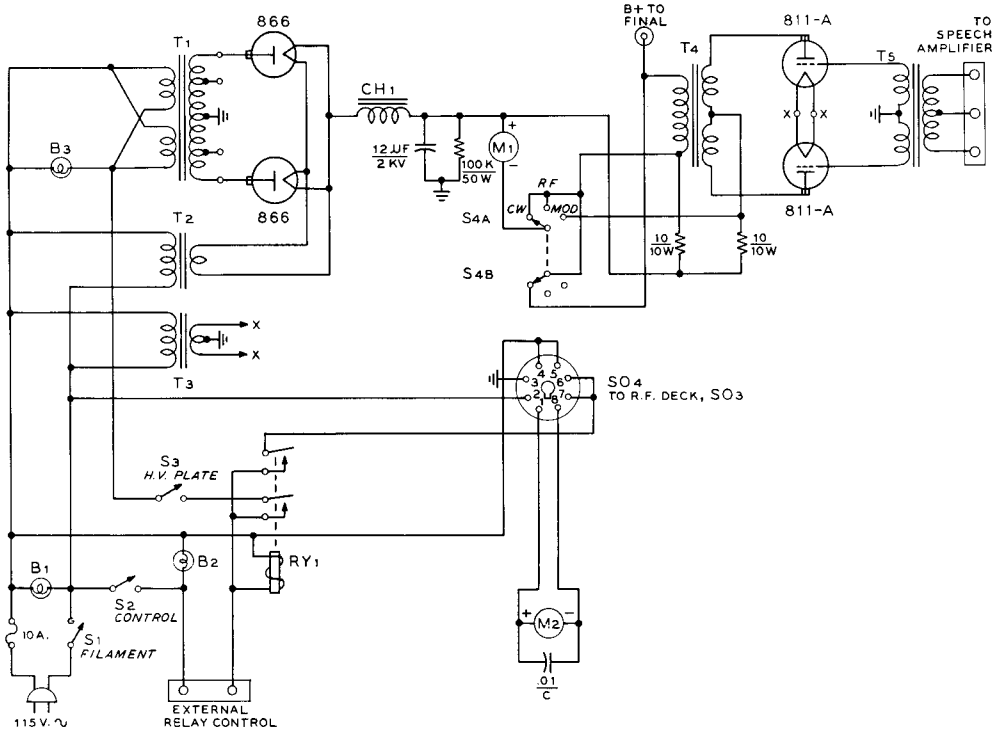

Figure 10
SCHEMATIC, POWER SUPPLY AND MODULATOR DECK

- T₁—1775/1500 each side c.t., 625 ma., ICAS. 115/230 volt primary. Stancor P-8029
- T₂—2.5 v., 10 a., 10KV insulation. Stancor P-3060
- T₃—6.3 v., 10 a. Stancor P-6308
- T₄—300 watt "polypedance" modulation transformer. Stancor A-3898. Primary impedance 12K, secondary impedance 6K
- T₅—"Polypedance" driver transformer. Stancor A-4762
- RY₁—DPDT relay, 10 ampere contacts, 115 v. a.c. coil
- M₁—0 - 500 ma.
- M₂—0 - 100 ma.
- S₁-A-B—2 pole, 3 position high voltage switch. (Found in "war surplus" BC-306A antenna tuning unit), or equivalent
- CH₁—500 ma. swinging choke, 2-16 h. Stancor C-1405
- B₁-2-3—115 volt pilot lamps
- SO₁—8 prong octal socket

movable shorting bar are mounted at the "B-plus" end of the assembly. The rotor of the "butter-fly" capacitor is left floating and is panel driven through a high voltage shaft coupling. The neutralizing capacitors (C₁₁, C₁₂) are mounted on a triangular piece of polystyrene or other good insulating material and placed between the tube sockets. Construction of these capacitors is shown in figure 13.

The 144 Mc. antenna link "coil" is a U-shaped pickup loop mounted beneath the linear tank circuit, while the 50 Mc. pickup coil is inserted between the turns of plate coil L₁₂. The single turn neutralizing coil L₁₄ is placed near one end of L₁₂ as shown in the photograph.

Placement of the major components beneath the chassis may be seen in figure 6. The linear tank circuit L₁A-B runs in zig-zag fashion from the plate terminals of the buffer tube V₅ to two ceramic standoff insulators mounted on the bottom plate of the power amplifier enclosure. Spacing between the lines is held constant, and they are supported at the buffer end on two 1" ceramic insulators. The buffer tuning capacitor C₁ is mounted to the chassis between the lines and panel driven with a phenolic shaft. The rotor of this capacitor is not grounded. The stators of C₁ are connected to the lines with short lengths of flexible strap. Any grid current unbalance in the final amplifier stage can be corrected by varying the

FIGURE 12
COIL CHART FOR 50-144 MC. TRANSMITTER

- L1-(144 MC. COIL) 36 T. #24 E., 1/2" DIA. MILLEN 69046 FORM.
 L2-(50 MC. COIL) 28 T. #24 E., 1/2" DIA. MILLEN 69046 FORM.
 L3- 52 TURNS # 28 E. MILLEN 69046 FORM.
 L4- 22 T. CENTER TAP, 3/4" DIA., 32 T.P.I. B&W 3072
 L5- 15 T. CENTER TAP, 1/2" DIA., 16 T.P.I. B&W 3003
 LINK COIL: ONE TURN HOOKUP WIRE.
 L6- 2 1/2 T. CENTER TAP, 1/2" DIA., 16 T.P.I. B&W 3003
 LINK COIL: ONE TURN HOOKUP WIRE.
 L7- 7 T. CENTER TAP, 5/8" DIA., 16 T.P.I. B&W 3007
 LINK COIL: ONE TURN HOOKUP WIRE.
 L8-(50 MC.) 7 T. CENTER TAP, 3/4" DIA., 8 T.P.I. B&W 3010
 LINK COIL: ONE TURN HOOKUP WIRE.
 (144 MC.) 3 1/4" X .02" X .125" COP. STRAP BENT "U". (SEE FIG. 7)
 LINK: 1 TURN HOOKUP WIRE BENT TO FIT L8.
 L9A-B- 11" #8 COPPER WIRE, OR .125" DIA. ROD, PLUS 3" OF
 1/2" WIDE FLEXIBLE COPPER STRAP (GRID LEAD) PLUS
 3/4" FLEXIBLE COPPER STRAP (PLATE LEAD). ADJUST
 SPACING FOR RESONANCE. (SEE FIG. 6 FOR LAYOUT)
 L10- 5 T., 3/4" DIA., # 14 E. WIRE. ADJUST SPACING OF TURNS
 FOR RESONANCE AT 50 MC. WITH C7 AT FULL CAPACITY.
 L11A-B- 10" OF 1/8" X 1 1/8" ALUMINUM STRAP, SPACED 3 3/8"
 CENTER TO CENTER. SHORTING BAR MADE OF SAME MAT-
 TERIAL, ATTACHED 6 7/8" FROM PLATE END TO CENTER
 OF BAR. PLATE PIN RECEPTACLES REMOVED FROM SOCKET
 AND ATTACHED TO ENDS OF LINES (SEE FIGURE 5)
 L12-(50 MC. COIL) 6 T., 1 1/4" DIA. #6 COPPER WIRE, OR .125"
 TUBING. SPACE TURNS TO RESONATE TO 50 MC. WITH
 C8 NEAR FULL CAPACITY.
 L13- 19" OF #12 E. WIRE BENT TO "U" SHAPE TO FORM 5" X 2"
 LOOP WITH 3 1/2" LEADS. PLACE UNDER L11A-B.
 L14- 1 TURN, 2" DIA., 10 KV. HOOKUP WIRE.
 L15- 1 TURN, 1/2" DIA. #16 E., WITH INSULATED SLEEVING.
 PLACE AT CENTER OF L10.
 L16- 2 TURNS, 1 1/4" DIA., 10 KV HOOKUP WIRE.

position of the taps on the lines until balanced current is obtained. The tuning range of the capacitor on 144 Mc. is reduced by moving the taps closer to the electrical center of the line.

An "L"-shaped shield plate passes around the edge of tripler capacitor C_1 - C_3 to shield the low power stages from the buffer plate lines. The under-chassis shielding is completed when a bottom plate is bolted to the chassis.

The power supply section occupies the rear portion of the chassis. High voltage rectifiers D_1 - D_3 are mounted above the deck (figure 4) and the diodes of the bias supply are mounted below the chassis.

Figure 9 shows the interior of the VFO compartment. The two oscillator coils are mounted on the side of the box, across from the four crystal sockets. The trimmer capacitors are mounted above their respective coils. The grid and cathode leads to oscillator tube V_1 pass through a large rubber grommet mounted in the bottom of the enclosure.

The Power and Modulator Deck

The power supply is mounted upon a steel chassis measuring 13" x

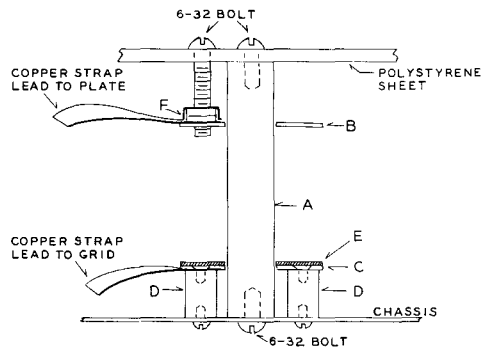

- A- 3/8" X 2" CERAMIC INSULATOR, TAPPED AT EACH END FOR 6-32 MACHINE SCREWS.
 B, C- 1 1/8" DIA. BRASS DISC WITH 3/8" CLEARANCE HOLE FOR CERAMIC INSULATOR. LOWER DISC SUPPORTED ON 3/8" CERAMIC INSULATORS. USE FLAT HEAD SCREWS.
 D- 3/8" CERAMIC INSULATORS.
 E- 1 1/8" DISC MADE OF TWO LAYERS OF .015" THICK TEFLON HELD ATOP C BY CELLOPHANE TAPE.
 F- TWO 6/32 NUTS PLACED UNDER STRAP. STRAP AND NUTS SOLDERED TO BRASS PLATE. HOLE IN PLATE PASSES 6/32 BOLT.

Figure 13
CONSTRUCTION OF
NEUTRALIZING CAPACITOR
FOR 826 STAGE

Two capacitors are required (C_{11} and C_{12}). Capacitors have top brace plate made of polystyrene sheet or other good VHF insulating material. Plate is supported on two ceramic insulators which form center support for capacitors. Plates of neutralizing capacitors are made of brass discs. The grid disc is supported on short ceramic insulators, and the plate disc is supported from the polystyrene plate by 6-32 machine screw. Plate encircles ceramic insulator with a close fit. Plate lead and two 6-32 nuts are soldered to top plate. Mounting screw passes through this assembly, and also through hole drilled in top plate. After capacitors have been adjusted, top plate is cemented to center ceramic insulator with clear nail polish to retain adjustment.

17" x 3", as shown in figure 11. The modulator and rectifier tubes are placed near the front panel, with the modulation transformer and power transformer to the rear of the chassis. The swinging choke is placed between the tubes at the front-center of the chassis. Smaller components are mounted beneath the chassis. High voltages are applied to the transmitter by primary relay RY_1 , controlled by switch S_2 and an optional external relay control circuit.

Transmitter Adjustment The tuned circuits of the transmitter can be set to their proper operating range with the aid of a grid-dip oscillator. All r-f tubes must be in their sockets. Coil L_3 is set to 8.5 Mc., and circuit C_2 - L_4 is adjusted to 17 Mc. with C_2 set at half-capacity. The 7 μ fd. trimmer

capacitor across L_5 is adjusted to resonate the plate circuit of the first tripler stage to 50 Mc. with C_3 at half-capacity, and C_3 - L_7 is tuned to the same frequency in the same manner with 50 Mc. plug PL-1 placed in socket SO-1. The grid coils of the buffer stage are next adjusted to frequency.

The next step is to adjust the plate circuit of the buffer stage. Coil L_{10} is attached to the transmission line about 2" from the feed-through terminals, and capacitor C_7 is tapped on the line about 1" closer to the buffer tube than is the coil. Resonance of the lines can be adjusted by changing the length of the flexible plate leads to the buffer tube, by varying the spacing of the lines, or by changing the spacing between the chassis and the lines. The tuning range of C_7 may be varied by shifting the position of the taps on the lines. Coil L_{10} is placed at the "cold" point of the line, which may be found by touching the line with a pencil lead when the transmitter is operating. Place the coil at the spot on the line that has the least "fire" when the transmitter is operating on 144 Mc.

As soon as grid current can be measured on the power amplifier, the stage may be neutralized. The transmitter is first neutralized on 144 Mc. by adjusting capacitors C_{11} and C_{12} . The B-plus lead should be removed for this operation. Operating frequency is then changed to 50 Mc. and link coils L_{14} and L_{15} are adjusted for complete neutralization on the six meter band. The 144 Mc. neutralization should then be rechecked. The links have very little effect at 144 Mc., since the shorting bar effectively removes L_{12} and L_{14} from the circuit. However, the adjustment of the capacitors affects the setting of the 50 Mc. links, so the latter must be readjusted after each change in

the settings of C_{11} and C_{12} .

Reduced voltage is now applied to the amplifier stage and it is loaded into a suitable antenna system. The links of coils L_5 , L_6 , L_7 , and L_8 should be adjusted for maximum grid drive. Loose coupling should be used as overcoupling reduces excitation to the power amplifier and results in "double tuning" of the stages. Buffer plate current runs about 100 milliamperes, and each amplifier tube should develop approximately 35 milliamperes of grid current.

The 144 Mc. antenna link (L_{13}) is adjusted by varying the length of the loop and its position to the lines. It is mounted beneath the lines and spaced about $\frac{3}{4}$ " away from them. Fine antenna loading may be controlled by loading capacitors C_9 and C_{10} . The amplifier may be loaded to 200 ma. for phone operation, or 250 ma. for c.w. operation. The overall amplifier efficiency is better than 50%, delivering 160 watts to a dummy load with a power input of 300 watts at 144 Mc. Efficiency is better than 60% at 50 Mc.

Modulator plate current rises to about 150 ma. on peaks for 100% modulation of the final amplifier.

31-2 A De-Luxe Transmitter for the 3.5 - 29.7 Mc. Range

Shown in this section is a de-luxe phone/c.w. transmitter for operation in the 80, 40, 20, 15, and 10 meter amateur bands. The transmitter runs 500 watts input on c.w. and 375 watts input on phone, and is completely self-contained in two small relay racks as illustrated in figure 14. The r.f. section of the transmitter is designed to be virtually TVI-proof, and modern techniques such as speech

Figure 14
DE-LUXE STATION FOR THE DX MAN

Employs VFO-controlled, bandswitching, Phone-CW transmitter running up to 500 watts.

This compact, all-band transmitter employs a 7094 tetrode in a pi-network amplifier, modulated by 811-A's. Clickless, break-in keying is used for c.w., and speech clipping and limiting are employed for AM phone. Modulator and power supply are in the rack at left, and entire r-f section is in right-hand rack. High stability VFO ensures drift-free frequency control. Transmitter is designed for maximum harmonic suppression and is virtually TVI-proof

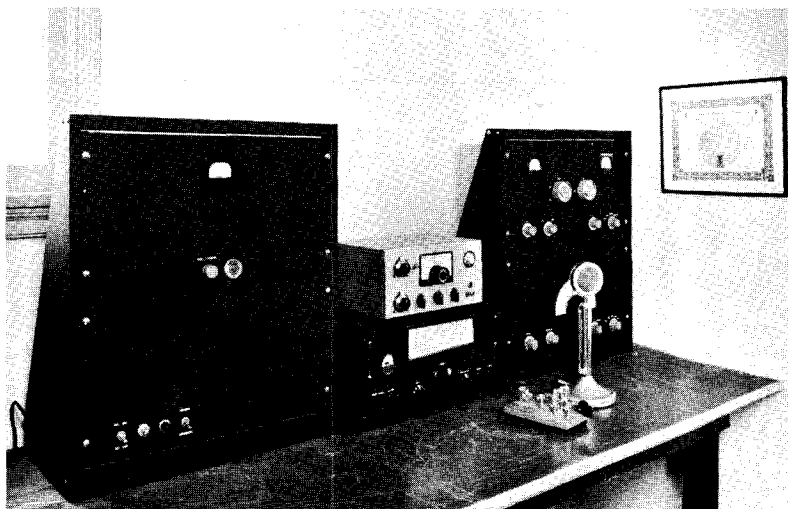

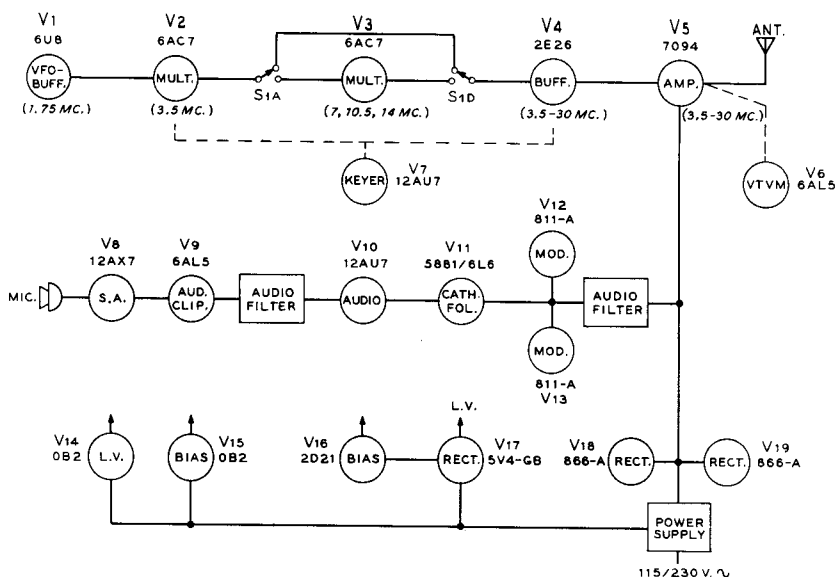

Figure 15

BLOCK DIAGRAM OF ALL-BAND 500 WATT TRANSMITTER

R-f section employs bandswitching exciter for coverage of 10, 15, 20, 40, and 80 meter bands. Variable frequency oscillator operates in 1.7 Mc. region to achieve maximum isolation. Tuning and antenna loading are aided by 6AL5 vacuum tube voltmeter monitoring output of amplifier stage. Low level speech clipping and filtering, combined with high level audio filter imports "punch" to phone signal, yet holds sidebands to a minimum. Single high voltage supply powers modulator and final amplifier.

clipping and clickless, break-in keying are incorporated in the transmitter.

A high stability variable frequency oscillator is employed for frequency control, the dial of which is directly calibrated for each band. Band changing is a simple operation and may be accomplished in a few seconds.

Transmitter Circuitry and Layout A block diagram of the transmitter is given in figure 15. Nineteen tubes are used in the equipment: seven in the r-f section, six in the audio section, and six in the power supply.

The RCA 7094 beam power tube is employed in the final amplifier stage. This compact tube has high perveance and high power gain. It can be operated at full input to 60 Mc., and has a maximum plate dissipation of 125 watts. In addition, it has triple base-pin connections for the screen grid to permit good r-f grounding and large plate radiating fins for effective cooling. The compact size makes it especially effective in the high frequency portions of the communication spectrum. Driving requirements are modest and permit the use of a simplified bandswitching exciter.

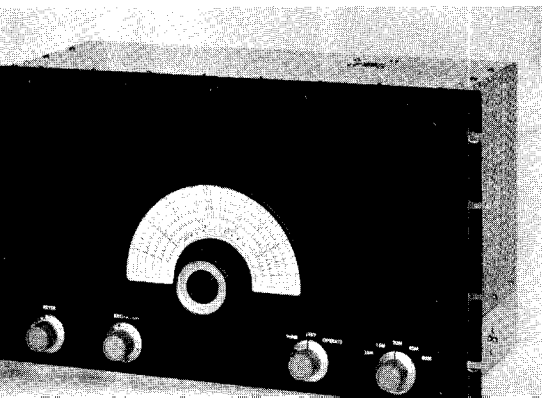
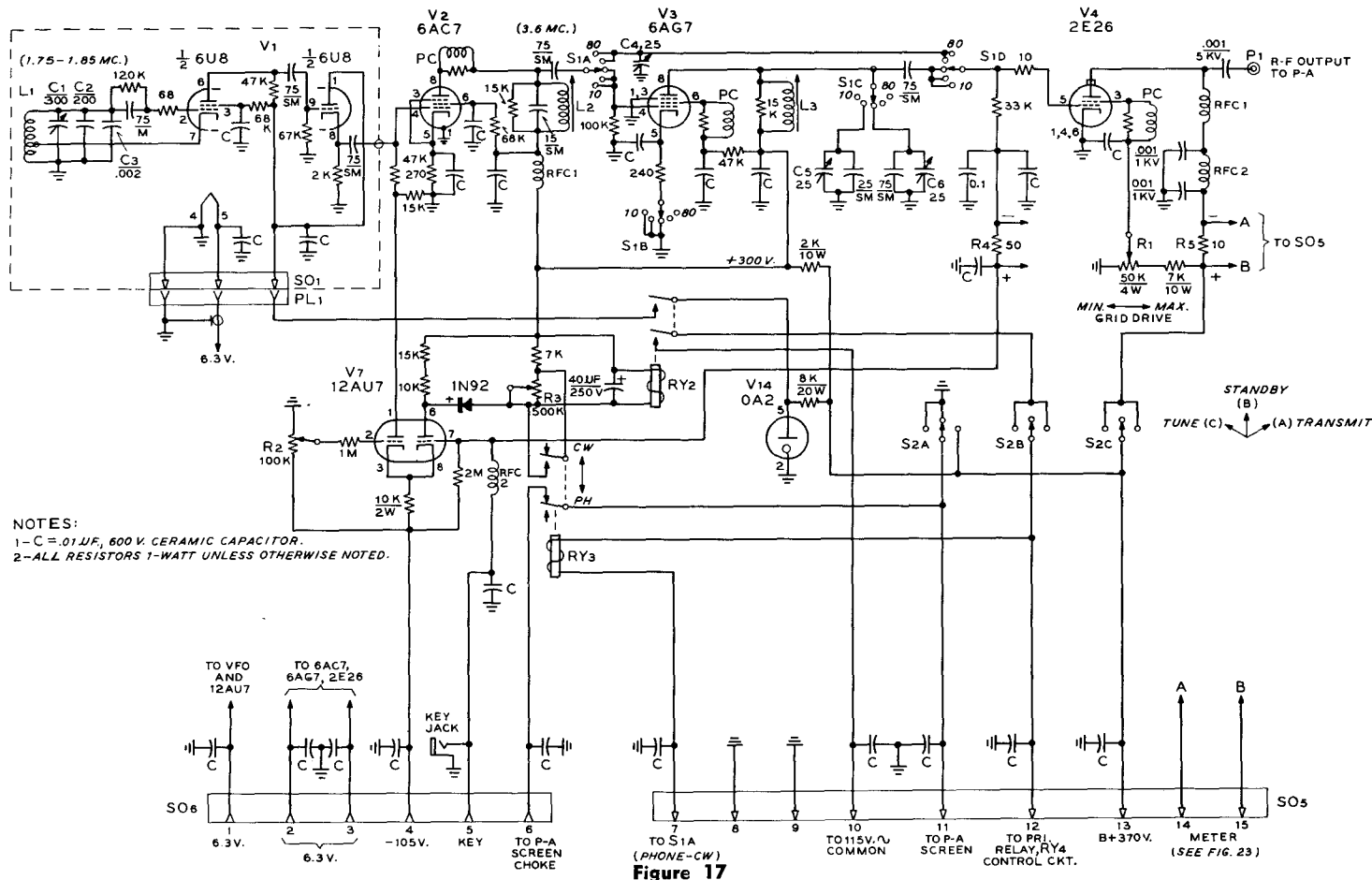

Figure 16
VFO-EXCITER DECK CONTAINS
ALL IMPORTANT OPERATING
CONTROLS

Low level r-f stages are built upon 8"x17"x2" aluminum chassis. Keyer timing potentiometer R_2 is at left, with excitation potentiometer R_1 , control switch S_2 , and bandswitch S_1 in line, left to right. VFO dial is centered on the panel.

Output connector P_1 is mounted on polystyrene plate atop shielded enclosure at right. Shielding is made from Reynold's "Do-it-yourself" perforated aluminum sheet.



SCHEMATIC, EXCITER DECK OF ALL-BAND TRANSMITTER

- C₁**—300 μ fd. Bud CE-2008 dual bearing capacitor
C₂—300 μ fd. silver mica capacitor. Vary for desired frequency coverage.
C₃—2000 μ fd. High accuracy capacitor, tolerance 1%, temperature coefficient zero, plus or minus 10 p.p.m. Centralab 950-202
C₄, C₅, C₆—25 μ fd. midget variable padding capacitor, ceramic
L₁—19 turns #20 e. wire, tapped 5 turns from ground end. Wound on ceramic form, 3/4" diam., 1" high. Space the winding by interwinding #28 e. wire, then remove. National XR-62 form.
L₂—30 turns #28 dsc., 1/2" diam., 1/2" long on National XR-50 form

- L₃**—21 turns #22 e., 1/2" diam., 1/2" long on National XR-50 form
S₁A-B-C-D—Two pole, 6 position decks (Centralab PA-3) with Centralab PA-301 index assembly.
S₂A-B-C—3 pole, 3 position rotary switch
RY₂—DPDT relay, 7,000 ohm d.c. coil
RY₃—DPDT relay, 115-volt a.c. coil
PC—52 ohm, 1-watt carbon resistor, wound with 3 turns #20 e. wire
RFC₁—2.5 mh. choke National R-100
RFC₂—VHF choke. Ohmite Z-144

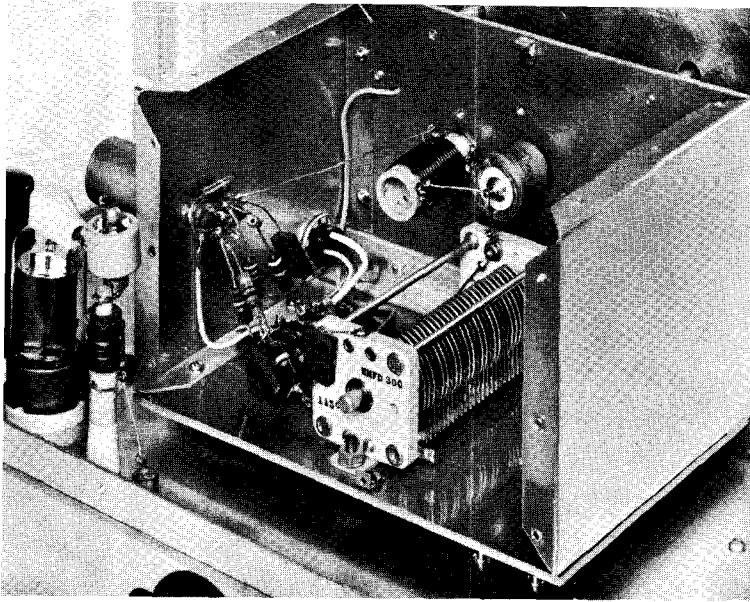

Figure 18
INTERIOR OF VFO
SHOWING
PLACEMENT OF
MAJOR
COMPONENTS

The VFO is built upon two 1/8-inch dural plates, one forming the base and the other forming the front of the oscillator enclosure. Inductor L_1 and padding capacitors are mounted to front wall, and the variable tuning capacitor is bolted to base. Oscillator tube (V-1) projects from rear wall of enclosure to remove as much heat from tuned circuit as possible. Entire VFO is mounted upon miniature shock mounts and dial is attached to VFO unit, rather than to rack panel. 6AG7 and 2E26 tubes are at left, with 2E26 plate choke and 5KV coupling capacitor in foreground.

The variable frequency oscillator and exciter stages are built upon one chassis deck, as shown in figures 16, 18, 19, and 20. The complete schematic of this unit is given in figure 17. The variable oscillator covers the range of 1.75 Mc. - 1.85 Mc., permitting full coverage of all amateur bands except the extreme top of the 28 Mc. band, and the top portion of the 80 meter band. Readjustment of the oscillator padding capacitor provides complete coverage of these segments, if desired. The VFO consists of a 6U8 pentode-triode (V_1) operating as a "hot cathode" oscillator and triode cathode follower. Extremely high-C is employed in the tuned circuit of the VFO to obtain a good order of stability. A 2000 μfd . precision ceramic capacitor C_2 , forms the large portion of the tuning capacitance, and the coil L_1 is wound upon a ceramic form having a very low temperature coefficient. The cathode follower stage provides excellent circuit isolation for the oscillator, combined with a minimum of plate circuit loading. Figure 18 shows the layout of the major oscillator components. The circuit is built upon an 1/8" thick aluminum plate, bolted to a small panel of the same material. The sides, back, and top of the oscillator enclosure are made of aluminum sheet. The complete unit is mounted upon miniature rubber shock mounts. The VFO dial is firmly affixed to the enclosure and actually does not make physical contact with the panel at all. The frequency determining unit is thereby protected from jolts and jars which might cause a "warble" in the transmitter frequency. The r-f output from the cathode follower is 5 volts, r.m.s.

Three tubes are employed in the multiplier and driver stages of the transmitter. The first 6AC7 doubler stage (V_2) operates into a broadly resonant slug-tuned coil L_2 . When tuning the exciter unit, this coil is peaked at 3.6 Mc. The stage will then deliver substantially constant output over the range from 3.2 to 4.0 Mc. The 2E26 stage (V_3) operates as an amplifier on the 3.5 Mc. band and as a doubler on the 7 Mc. band, driven directly from the 6AC7 buffer-doubler.

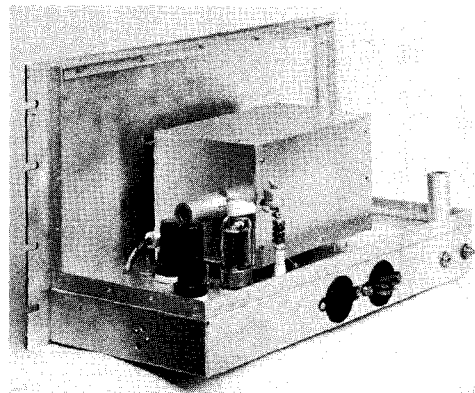

Figure 19
REAR VIEW OF EXCITER DECK

Multiplier tubes are in the foreground. Adjustment holes for the multiplier trimmer capacitors are on side of chassis. 1/2-inch angle stock is run around chassis and panel to form foundation to which the perforated enclosure is attached. Keyer tube V_4 is placed in rear corner. Potentiometer R_1 and auxiliary key jack are on chassis wall below keyer tube. Short lead extends from 2E26 blocking capacitor up to connecting plug P_1 mounted on enclosure.

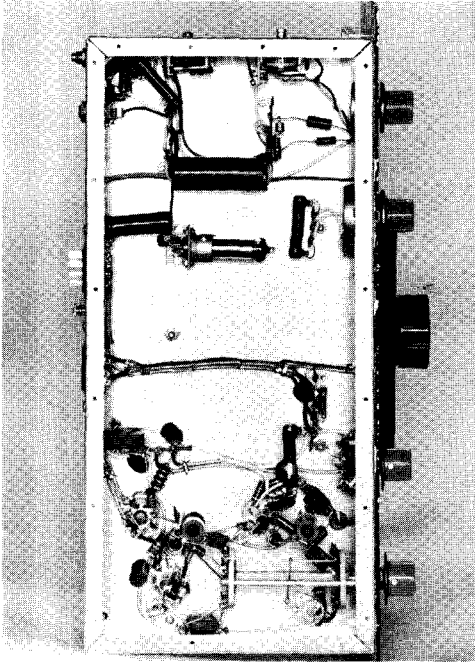

Figure 20
UNDER-CHASSIS VIEW OF EXCITER

All power wiring is run in shielded braid, grounded to the chassis at convenient points. Voltage regulator tube V_{12} is mounted beneath the chassis on small angle brackets. RY_2 and RY_3 are mounted to the inner chassis wall, directly behind keyer panel control R_3 . R-f circuits are at the opposite end of chassis, grouped around bandswitch S_1 . The slugs of coils L_2 and L_3 are adjustable from atop the chassis. Metal plate covers bottom of chassis to reduce spurious radiation from r.f. circuits.

For operation on 20, 15, and 10 meters, switch S_1D disconnects the 2E26 from the 6AC7 stage, and connects it to an auxiliary 6AG7 frequency multiplier (V_8). The multiplier operates as either a doubler, a tripler, or as a quadrupler. Its output circuit, therefore, is either tuned to 7 Mc., 10.5 Mc., or 14 Mc. Coil L_3 in the plate circuit of the 6AG7 resonates with residual circuit capacities to 14 Mc. Switch section S_1C of the bandswitch adds additional capacity to lower the resonant frequency of this circuit to 10.5 Mc. or 7 Mc.

The 2E26 stage operates as a doubler to 14 Mc., receiving 7 Mc. excitation from the 6AG7 stage. When the 6AG7 is tuned to 10.5 Mc., the 2E26 serves as a doubler to the 21 Mc. band. For 28 Mc. output from the 2E26, 14 Mc. excitation is received from the 6AG7 stage, and the 2E26 again functions as a doubler.

Keying and Control Circuit

A simplified schematic of the keying and control circuit for the exciter is shown in figure 21. A break-in type keyer is employed for c.w. operation. The unit is completely actuated by the transmitter key. When the key is pressed the transmitter is energized and may be keyed in a normal manner. The keyer "holds" the transmitter power supplies on while the key is manipulated. When the operator stops, the keyer turns off the transmitter after a short pause. Thus, the transmitter remains on between keyed characters and words,

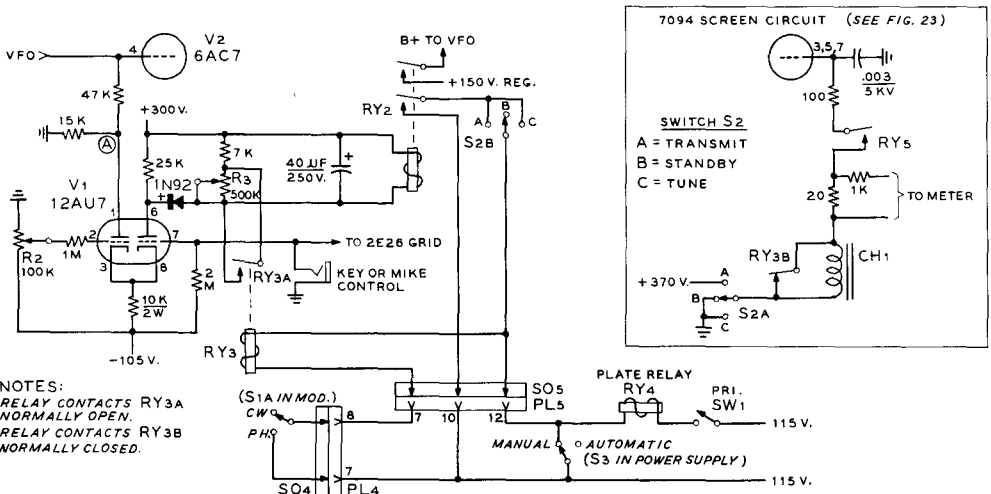

Figure 21
KEYER AND CONTROL CIRCUITS

Clickless, break-in keying is provided by this simple control circuit. See text for full details of operation

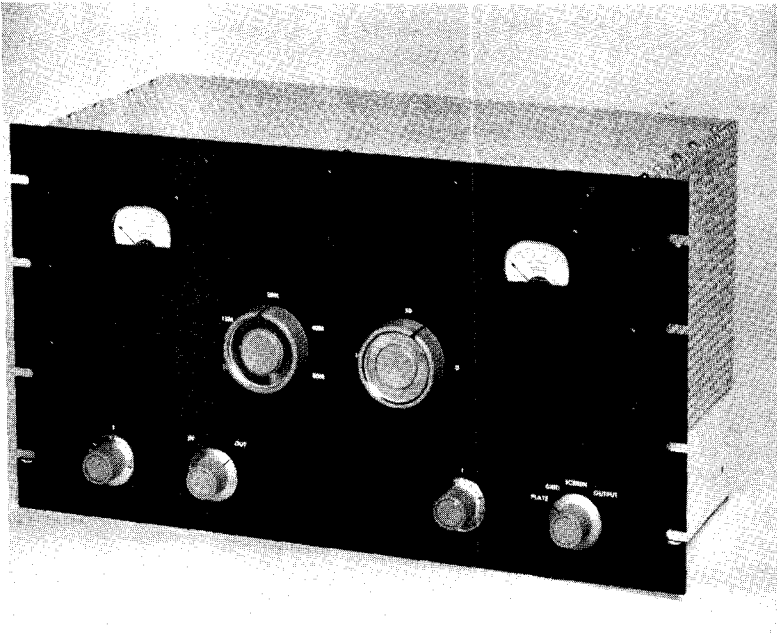

Figure 22
500 WATT POWER
AMPLIFIER HAS
SYMMETRICAL
PANEL LAYOUT

The 7094 amplifier stage is enclosed in a separate deck. Plate milliammeter is at left, with 0-1 d.c. milliammeter at right which may be inserted in various power leads in exciter or amplifier. Large center knobs are (left) pi-network switch and (right) main amplifier tuning control.

Controls across the bottom are (left to right): Pi-network loading capacitor, auxiliary pi-network capacitor switch, grid circuit tuning capacitor, and meter switch. Pi-network switch S_1 is ganged with grid turret switch S_2 , eliminating one panel control.

but will return to a stand-by position after the keying action has been completed. The "turn-off" time may be varied to suit the operator's taste. For phone operation, the time delay circuit is eliminated, and the push-to-talk circuit actuates the keyer and control relays directly. The whole sequence may be over-riden and manual operation restored by means of a "manual-automatic" switch on the power supply chassis. Finally, a "transmit-tune-standby" switch S_2A removes screen voltage from the final amplifier stage for tune-up purposes.

Referring to figure 21, the sequence of operation is as follows:

1—Key up, switch S_2B on "transmit."

The right-hand section of the keyer tube V_7 is cut off by the negative bias on the cathode. Potentiometer R_2 is adjusted for 1 ma. current through 15K resistor to ground (-15 volts to chassis at point A). 6AC7 (V_2) is cut off.

2—Key is depressed.

Right-hand section of V_7 conducts heavily and cathode voltage rises quickly, cutting off left section of V_7 and removing blocking bias of 6AC7 (V_2). Plate current of right-hand section of V_7 operates RY_2 and charges 40 μ fd. capacitor through 1N92 diode. The relay closes, placing B-plus voltage on oscillator stage and operating

the high voltage primary circuit relay circuit. This circuit may be rendered inoperative on "standby" position by switch S_2B , enabling VFO to be used for frequency check or "spotting" purposes.

3—Key is released.

Right-hand section of V_7 cuts off immediately. Left-hand section draws 1 ma. and cuts off 6AC7 buffer tube. The 1N92 is back-biased by rise in 12AU7 plate voltage, keeping charge on 40 μ fd. capacitor. Relay RY_2 remains closed until capacitor is discharged through shunting resistances. Relay then opens, turning off high voltage supplies of transmitter. "Release" delay is controlled by potentiometer R_3 .

4—Phone Operation

Switch S_1 on modulator deck is closed for phone operation, placing the coil of relay RY_3 in the circuit. When the key is closed, or the press-to-talk circuit activated, RY_3A shorts out the time delay circuit of RY_2 , and at the same time RY_3B removes a short across the screen modulation choke in the final amplifier.

Exciter plate voltage is obtained from the modulator power supply (See Chapter 30, figure 17), and bias and amplifier voltage are derived from the main power supply, located on a separate chassis. The plate relay RY_4 may be actuated by switch S_3 or by the keyer circuit.

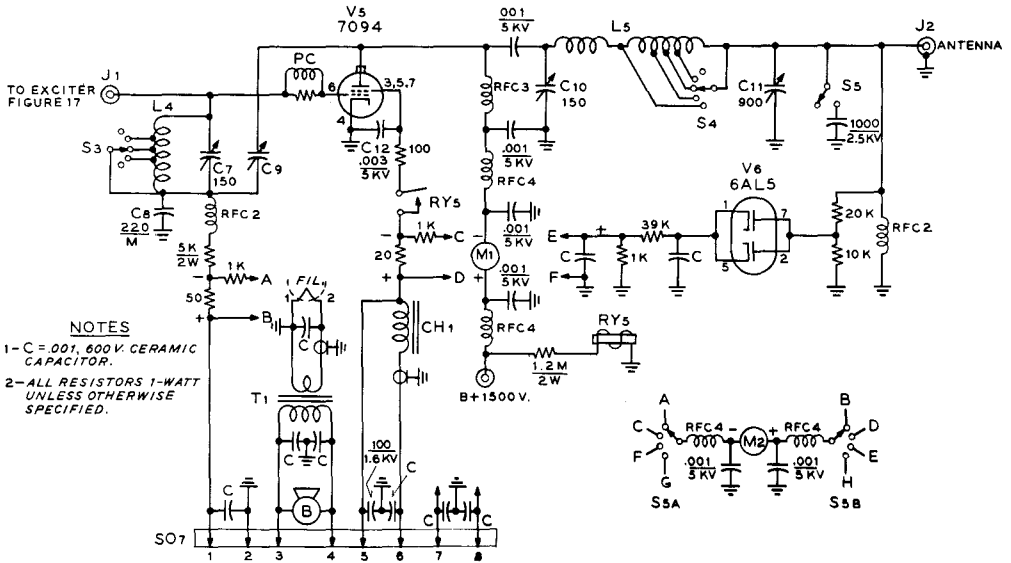

NOTES
 1-C = .001, 600V CERAMIC CAPACITOR.
 2-ALL RESISTORS 1-WATT UNLESS OTHERWISE SPECIFIED.

Figure 23
SCHEMATIC, 500 WATT POWER AMPLIFIER

- C₇—150 μ fd.
- C₈—220 μ fd., 1250 volt fixed mica capacitor
- C₉—Disc-type neutralizing capacitor. National NC-800 or equivalent.
- C₁₀—150 μ fd., 3000 volt. Johnson 150E30
- C₁₁—900 μ fd. Two gang broadcast capacitor (see text).
- C₁₂—Three .001, 5KV ceramic capacitors. Centralab type 850. Place one capacitor on each screen terminal.
- L₄—Composed of two coils mounted on back of S₃ and connected in series.
 80 meter coil: 28 turns, 1" diam., 1 3/4" long. 40 meter tap at 18th turn from "cold" end.
 20 meter coil: 7 turns, 1" diam., 1 1/2" long. 15 meter tap at 4 turns, 10 meter tap at 3 turns from "cold" end. Adjust taps with grid-dip oscillator.
- L₅-S₃—Barker & Williamson #3850, 500 watt turret for 10-80 meters.
- S₃—Single pole, 6 position ceramic switch, progressively shorting. Centralab PA-2042.
- RFC₂—2.5 mh. choke. National R-100
- RFC₃—Heavy duty choke for 3-30 Mc. range, 500 ma. Raypar RL-102
- RFC₄—VHF Choke, Ohmite Z-144, or equivalent
- PC—50 ohm composition resistor wound with 3 turns #20 e.
- T₁—6.3 volts at 4 a. Stancor P-4019
- CH₁—7 h. at 50 ma. Stancor C-1707
- RY₅—SPST sensitive relay, with 1 milliamperere d.c. coil
- M₁—0 - 500 d.c. milliammeter with insulated zero-set and bakelite case.
- B—Small 115-volt a.c. blower motor.

The Amplifier Stage The schematic of the amplifier is shown in figure 23, and various layout photographs are given in figures 22, 24, 25, and 26. Particular attention is given to TVI-reduction measures in the construction of the unit. A single 7094 beam power tube is used in a pi-network circuit. The grid circuit (L₄-C₇) is common to the plate circuit of the 2E26 and is capable of complete frequency coverage by virtue of the tapped coil assembly shown in the under-chassis view. Bridge neutralization is employed to achieve maximum stability. Variable capacitor C₈ and the grid bypass capacitor C₉ form two legs of the bridge. To take advantage of the triple base-pin connections to the screen of the 7094 three separate low inductance bypass capacitors (C₁₂) are used in the screen circuit, one attached

to each of the screen socket terminals. A VHF parasitic choke (PC) is included in the lead to the control grid of the tube. As a result of these precautions, the amplifier is completely stable over the whole operating range. A sensitive relay RY₅ is incorporated in the screen circuit to protect the tube under conditions of low plate potential. The relay will open the screen circuit when the plate potential is removed from the amplifier stage. By far the most frequent type of damage to a tetrode tube is caused when full screen voltage is applied in the absence of plate voltage. The screen relay protects the tube from this type of damage. Self-modulation of the screen is accomplished by an iron core choke CH₁ in the screen circuit. This choke is shorted out by relay RY₅B (figure 21) for c.w. operation. A pi-network configuration is used in the

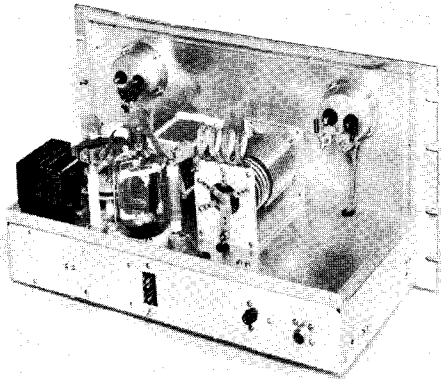

Figure 24
REAR OBLIQUE VIEW OF
PI-COUPLED AMPLIFIER

Dural angle strips are mounted around edge of 8"x17"x2" aluminum chassis and panel to which TVI enclosure is attached with self-tapping sheet metal screws. Meters are encased in aluminum cups, with r.f. filters mounted on the back of each case. Meter leads are 10 KV television cable, enclosed in shielded braid. The 7094 tetrode is mounted at rear of chassis, with neutralizing capacitor C_5 to left, and plate choke at right. Connections to plate of tube are made with flexible copper strap.

Filament transformer is at left of chassis, with blower motor hidden behind it. Output capacitor of pi-network is below deck.

plate circuit of the amplifier, employing one of the new *Barker & Williamson* 500 watt band-switching assemblies. A two-gang broadcast capacitor is employed for the low impedance output loading control. Switch S_5 allows the insertion of an extra 1000 $\mu\text{fd.}$ capacitor for operation into low impedance loads at 3.5 Mc. The output circuit of the network is monitored by a 6AL5 vacuum-tube voltmeter (V_6) which may be employed during tune-up and loading adjustments.

All power leads beneath the chassis are shielded in flexible braid, grounded at convenient points to the chassis. The meters are encased in spun aluminum cups that are bolted to the panel of the stage. Each meter lead is bypassed to the chassis with a .001, 5KV ceramic capacitor and a VHF choke is placed in series with the meter terminal. A small 115-volt blower motor is mounted at one end of the chassis (figure 25) to direct a cooling movement of air across the envelope of the tube.

Placement of the major components beneath the chassis may be seen in figure 26. An aluminum partition separates the pi-network components from the tube socket and the grid circuit. The grid coil switch (S_3) is driven by

means of a dial cord and drum from the plate bandswitch inductor shaft (L_5) atop the chassis. The cord passes through two holes in the chassis deck. The main bandswitch control on the amplifier panel thus actuates both the grid and plate switches. Safety relay RY_2 is mounted on the rear apron of the chassis, and an aluminum plate covers the complete under-chassis area. A one-inch hole is cut in this plate directly below the stator terminal of grid tuning capacitor C_7 , and a banana jack is mounted to a polystyrene plate bolted in place over the hole. This forms the low capacity input terminal, J_1 . A mating hole is cut in the top of the exciter screen and covered with a second polystyrene plate having a banana plug mounted in the center. When the amplifier is slipped in the rack the plug and jack mate, forming the connection between the 2E26 plate and the tuned tank in the grid circuit of the final amplifier.

Power Supply and Modulator The power supply is built upon a separate chassis, as shown in figure 27. Two 866A rectifier tubes are employed with a choke input filter to supply 1500 volts at 500 milliamperes for the r-f amplifier and modulator. "Hash" suppression chokes are placed in the rectifier plate leads to reduce the high frequency "buzz" sometimes super-imposed upon the carrier by mercury vapor tubes. Sufficient capacity must be used in the filter system to afford good dynamic stability to the supply under keyed loads, or under conditions

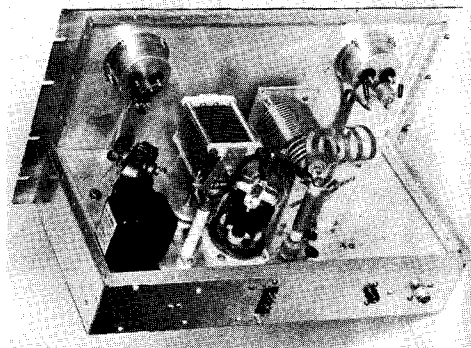

Figure 25
LEFT OBLIQUE VIEW OF
PI-COUPLED AMPLIFIER

Blower motor to cool 7094 tube is located between front panel and filament transformer. High voltage and coaxial antenna terminals are on right of rear wall of chassis. Addition of perforated screen makes enclosure radiation-proof.

HANDBOOK

of heavy modulation. Eight 60 $\mu\text{fd.}$, 450 volt tubular electrolytic capacitors are connected in series parallel to form a 30 $\mu\text{fd.}$, 1800 volt unit. A small bias supply delivering -105 volts for the 7094 amplifier and keyer is also included on the chassis. Layout and wiring of the supplies are shown in figures 27 and 29.

The modulator has been previously shown in Chapter 30, figure 17. The speech amplifier supply provides 370 volts for exciter operation. One section of the "phone-c.w." relay (RY₂A) shorts out the time delay circuit on the exciter deck for phone operation, and a high voltage relay RY₁ is employed to remove the modulator for c.w. operation. Six volts is also supplied to the exciter for filament service. This filament circuit is balanced to ground to reduce residual hum in the speech amplifier, so the ground circuit cannot be employed as a filament return in the exciter.

Exciter Tune-up and Operation Each deck of the transmitter should be tested as an individual unit before the transmitter is tested in entirety. Screen voltage of the 2E26 stage should always be set at zero by means of potentiometer R₁ (figure 17) when the exciter is operated without the final amplifier, since the 2E26 plate circuit is incomplete, and excessive screen current will be drawn by the 2E26 unless the screen potential is removed.

Oscillator calibration may be adjusted by varying the spacing of the turns of coil L₁, or

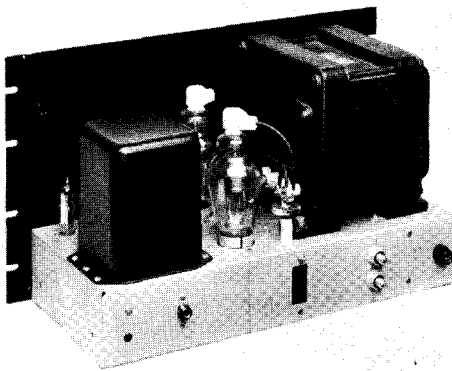

Figure 27
REAR VIEW OF POWER SUPPLY
Primary power leads pass through bulkhead-type filter capacitors to prevent radiation of TVI-producing harmonics from power line. Voltage regulator tube for bias supply is visible in corner of chassis.

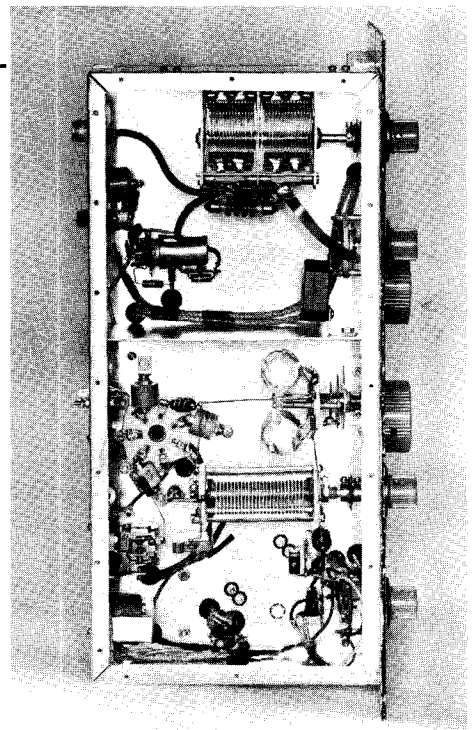

Figure 26
UNDER-CHASSIS VIEW OF POWER AMPLIFIER

All power wiring beneath the chassis is placed within braid to reduce pickup of r.f. energy. Note that shield divides area into two sections. Smaller area contains output capacitor of pi-network, 6AL5 diode voltmeter and high voltage leads. Larger area contains grid circuit components and meter switch. Sensitive relay RY₁ is mounted to wall of the chassis behind the grid tuning capacitor. Three .001, 5 Kv. ceramic screen bypass capacitors are mounted close to socket terminals. Grid turret switch is driven from plate turret atop chassis.

by changing the value of the auxiliary padding capacitor C₂. Alignment of the 6AC7 and 6AG7 stages is done by observation of the grid current of the 2E26 stage, as measured across shunt resistor R₄ in the grid return circuit. This circuit is not connected to the meter switch, since it requires only one preliminary reading during initial tune-up. Coil L₂ is peaked at about 3.6 Mc. with padding capacitor about half meshed. If grid current to the 2E26 is excessive, the 15K resistor shunted across coil L₂ may be reduced in value. Grid current should remain between 2 and 3 milliamperes across any band.

After 80 meter alignment is completed, bandswitch S₁ is set to the 10 meter position. The slug of coil L₃ is adjusted for maximum grid current across the 28 Mc. band. Coil L₃ resonates to 14 Mc. for this operation. The bandswitch is next set to the 15 meter position and the VFO tuned to 21.2 Mc. Padding ca-

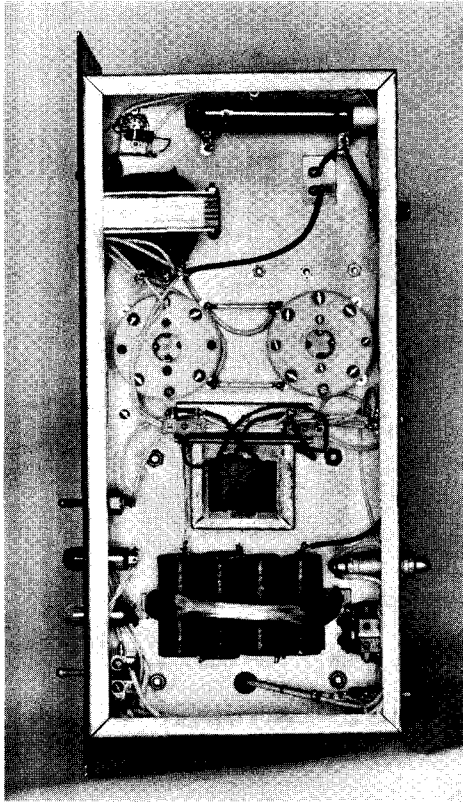

Figure 29
UNDER-CHASSIS LAYOUT OF PARTS IN POWER SUPPLY

The 866-A sockets are sub-mounted on 1/2-inch ceramic insulators. Eight electrolytic capacitors are mounted on phenolic plate and banded with insulated strap to form high voltage filter capacitor. Bias transformer is next to rectifier tube sockets. All high voltage connections are made with 5 KV television-type wire.

Preliminary Amplifier Adjustment

The amplifier stage may be neutralized by supplying excitation to the input circuit until rectified grid current flows. A jumper is placed across the antenna output jack J₂ and plate tuning capacitor C₁₀ is resonated to frequency. Neutralizing capacitor C₉ is now adjusted until the tuning of the plate capacitor has no effect upon the reading of the rectified grid current.

Preliminary tune-up into an antenna may be done with the control switch (S₂, figure 17) in the "stand-by" position. Screen voltage is removed from the final amplifier screen circuit. Also, screen voltage cannot be applied to the tube unless relay RY₅ (fig. 23) is closed by applying plate voltage to the amplifier stage.

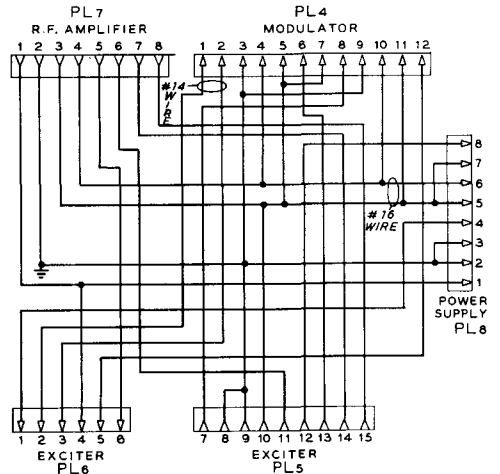

(A) NOTE: ALL CHASSIS OF TRANSMITTER ARE BONDED TOGETHER WITH SEPARATE GROUND LEAD.

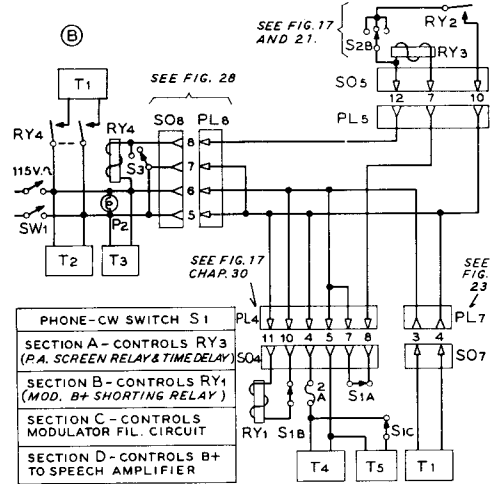
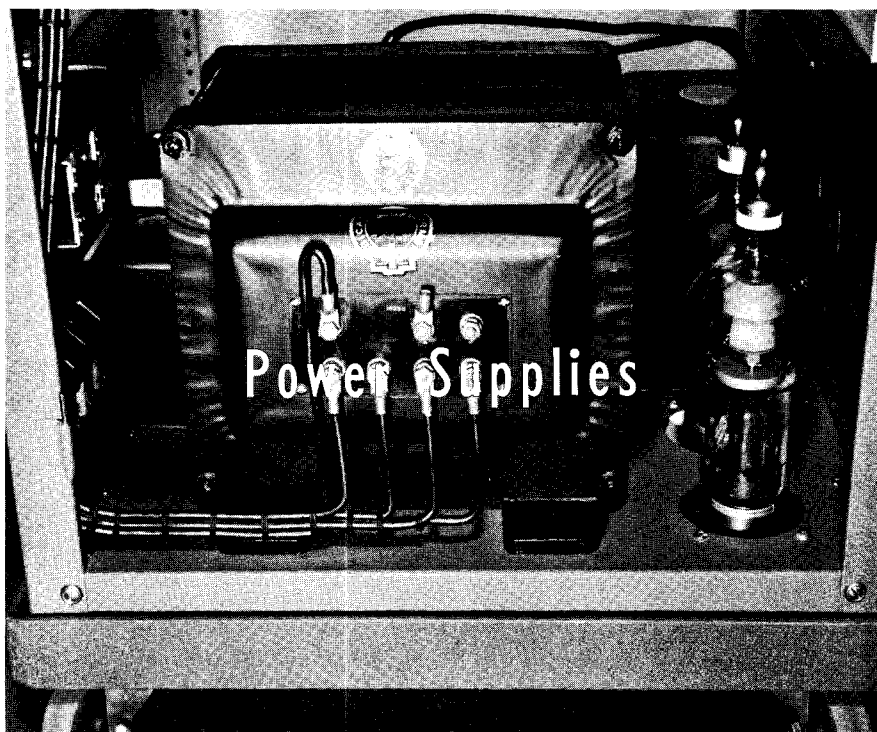

Figure 30
INTERCONNECTING CABLES FOR TRANSMITTER

Control Cables and Power Leads

After testing is completed, the units should be placed in the racks or cabinets and control cables made up as shown in figure 30. Wire sizes should be observed, as several of the leads carry large values of filament current. In addition, a separate grounding lead should be run between the individual chassis as a safety measure. Do not depend upon a metal relay rack for a ground return. All external cables should be laced for neat appearance. A typical layout of this equipment is shown in figure 14.



In view of the high cost of iron-core components such as go to make up the bulk of a power supply, it is well to consider carefully the design of a new or rebuilt transmitter in terms of the minimum power supply requirements which will permit the desired performance to be obtained from the transmitter. Careful evaluation of the power supply requirements of alternative transmitter arrangements will permit the selection of that transmitter arrangement which requires the minimum of power supply components, and which makes most efficient use of such power supplies as are required.

32-1 Power Supply Requirements

A power supply for a transmitter or for a unit of station equipment should be designed in such a manner that it is capable of delivering the required current at a specified voltage, that it has a degree of regulation consistent with the requirements of the application, that its ripple level at full current is sufficiently low for the load which will be fed, that its internal impedance is sufficiently low for the

job, and that none of the components shall be overloaded with the type of operation contemplated.

The meeting of all the requirements of the previous paragraph is not always a straightforward and simple problem. In many cases compromises will be involved, particularly when the power supply is for an amateur station and a number of components already on hand must be fitted into the plan. As much thought and planning should be devoted to the power-supply complement of an amateur station as usually is allocated to the r-f and a-f components of the station.

The arrival at the design for the power supply for use in a particular application may best be accomplished through the use of a series of steps, with reference to the data in this chapter by determining the values of components to be used. The first step is to establish the operating requirements of the power supply. In general these are:

1. Output voltage required under full load.
2. Minimum, normal, and peak output current.
3. Voltage regulation required over the current range.

Figure 1
POWER SUPPLY
CONTROL PANEL

A well designed supply control panel has separate primary switches and indicator lamps for the filament and plate circuits, overload circuit breaker, plate voltage control switch and primary circuit fuses.

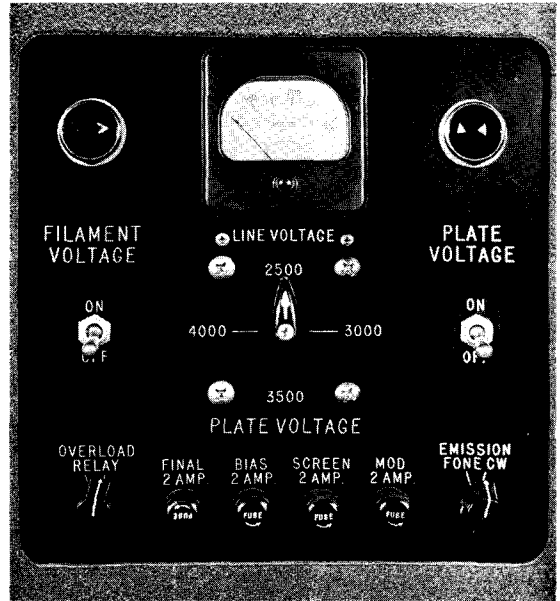

4. Ripple voltage limit.

5. Rectifier circuit to be used.

The *output voltage* required of the power supply is more or less established by the operating conditions of the tubes which it will supply. The *current rating* of the supply, however, is not necessarily tied down by a particular tube combination. It is always best to design a power supply in such a manner that it will have the greatest degree of flexibility; this procedure will in many cases allow an existing power supply to be used without change as a portion of a new transmitter or other item of station equipment. So the current rating of a new power supply should be established by taking into consideration not only the requirements of the tubes which it immediately will feed, but also with full consideration of the best matching of power supply components in the most economical current range which still will meet the requirements. It is often long-run economy, however, to allow for any likely additional equipment to be added in the near future.

Current-Rating Considerations The *minimum current drain* which will be taken from a power supply will be, in most cases, merely the bleeder current. There are many cases where a particular power supply will always be used with a moderate or heavy load upon it, but when the supply is a portion of a transmitter it is best to consider the mini-

imum drain as that of the bleeder. The minimum current drain from a power supply is of importance since it, in conjunction with the nominal voltage of the supply, determines the minimum value of inductance which the input choke must have to keep the voltage from soaring when the external load is removed.

The *normal current rating* of a power supply usually is a round-number value chosen on the basis of the transformers and chokes on hand or available from the catalog of a reliable manufacturer. The current rating of a supply to feed a steady load such as a receiver, a speech amplifier, or a continuously-operating r-f stage should be at least equal to the steady drain of the load. However, other considerations come into play in choosing the current rating for a keyed amplifier, an amplifier of SSB signals, or a class B modulator. In the case of a supply which will feed an intermittent load such as these, the current ratings of the transformers and chokes may be *less* than the maximum current which will be taken; but the current ratings of the rectifier tubes to be used should be at least equal to the maximum current which will be taken. That is to say that 300-ma. transformers and chokes may be used in the supply for a modulator whose resting current is 100 ma. but whose maximum current at peak signal will rise to 500 ma. However, the rectifier tubes should be capable of handling the full 500 ma.

The iron-core components of a power supply which feeds an *intermittent* load may be chosen on the basis of the current as averaged over a period of several minutes, since it is *heating* effect of the current which is of greatest importance in establishing the ratings of such components. Since iron-core components have a relatively large amount of thermal inertia, the effect of an intermittent heavy current is offset to an extent by a key-up period or a period of low modulation in the case of a modulator. However, the current rating of a rectifier tube is established by the magnitude of the emission available from the filament of the tube; the maximum emission must not be exceeded even for a short period or the rectifier tube will be damaged. The above considerations are predicated, however, on the assumption that none of the iron-core components will become saturated due to the high intermittent current drain. If good-quality components of generous weight are chosen, saturation will not be encountered.

Voltage Regulation The general subject of *voltage regulation* can really be divided into two sub-problems, which differ greatly in degree. The first, and more common, problem is the case of the normal power supply for a transmitter modulator, where the current drain from the supply may vary over a ratio of four or five to one. In this case we desire to keep the voltage change under this varying load to a matter of 10 or 15 per cent of the operating voltage under full load. This is a quite different problem from the design of a power supply to deliver some voltage in the vicinity of 250 volts to an oscillator which requires two or three milliamperes of plate current; but in this latter case the voltage delivered to the oscillator must be constant within a few volts with small variations in oscillator current and with large variations in the a-c line voltage which feeds the oscillator power supply. An additional voltage regulation problem, intermediate in degree between the other two, is the case where a load must be fed with 10 to 100 watts of power at a voltage below 500 volts, and still the voltage variation with changes in load and changes in a-c line voltage must be held to a few volts at the output terminals.

These three problems are solved in the normal type of installation in quite different manners. The high-power case where output voltage must be held to within 10 to 15 per cent is normally solved by using the proper value of inductance for the input choke and proper

value of bleeder at the output of the power supply. The calculations are simple: the inductance of the power-supply input choke at minimum current drain from the supply should be equal in henries to the load resistance on the supply (at minimum load current) divided by 1000. This value of inductance is called the *critical* inductance and it is the minimum value of inductance which will keep the output voltage from soaring in a choke-input power supply with minimum load upon the output. The minimum load current may be that due to the bleeder resistor alone, or it may be due to the bleeder plus the minimum drain of the modulator or amplifier to which the supply is connected.

The low-voltage low-current supply, such as would be used for a v.f.o. or the high-frequency oscillator in a receiver, usually is regulated with the aid of glow-discharge gaseous-regulator tubes. These regulators are usually called "VR tubes." Their use in various types of power supplies is discussed in Section 32-7. The electronically-regulated power supply, such as is used in the 10 to 100 watts power output range, also is discussed later on in this chapter and examples are given.

Ripple Considerations The *ripple-voltage* limitation imposed upon a power supply is determined by the load which will be fed by the supply. The tolerable ripple voltage from a supply may vary from perhaps 5 per cent for a class B or class C amplifier which is to be used for a c-w stage or amplifier of an FM signal down to a few hundredths of one per cent for the plate-voltage supply to a low-level voltage amplifier in a speech amplifier. The usual value of ripple voltage which may be tolerated in the supply for the majority of stages of a phone transmitter is between 0.1 and 2.0 per cent.

In general it may be stated that, with 60-cycle line voltage and a single-phase rectifier circuit, a power supply for the usual stages in the amateur transmitter will be of the choke-input type with a single pi-section filter following the input choke. A c-w amplifier or other stage which will tolerate up to 5 per cent ripple may be fed from a power supply whose filter consists merely of an adequate-size input choke and a single filter capacitor.

A power supply with input choke and a single capacitor also will serve in most cases to feed a class B modulator, provided the output capacitor in the supply is sufficiently large. The output capacitor in this case must be capable of storing enough energy to supply the

peak-current requirement of the class B tubes on modulation peaks. The output capacitor for such a supply normally should be between 4 μ fd. and 20 μ fd.

Capacitances larger than 20 μ fd. involve a high initial charging current when the supply is first turned on, so that an unusually large input choke should be used ahead of the capacitor to limit the peak-current surge through the rectifier tubes. A capacitance of less than 4 μ fd. may reduce the power output capability of a class B modulator when it is passing the lower audio frequencies, and in addition may superimpose a low-frequency "growl" on the output signal. This growl will be apparent only when the supply is delivering a relatively high power output; it will not be present when modulation is at a low level.

When a stage such as a low-level audio amplifier requires an extremely low value of ripple voltage, but when regulation is not of importance to the operation of the stage, the high degree of filtering usually is obtained through the use of a *resistance-capacitance* filter. This filter usually is employed in addition to the choke-capacitor filter in the power supply for the higher-level stages, but in some cases when the supply is to be used only to feed low-current stages the entire filter of the power supply will be of the resistance-capacitance type. Design data for resistance-capacitance filters is given in a following paragraph.

When a low-current stage requires very low ripple in addition to excellent voltage regulation, the power supply filter often will end with one or more gaseous-type voltage-regulator tubes. These VR tubes give a high degree of filtering in addition to their voltage-regulating action, as is obvious from the fact that the tubes tend to hold the voltage drop across their elements to a very constant value regardless of the current passing through the tube. The VR tube is quite satisfactory for improving both the regulation and ripple characteristics of a supply when the current drain will not exceed 25 to 35 ma. depending upon the type of VR tube. Some types are rated at a maximum current drain of 30 ma. while others are capable of passing up to 40 ma. without damage. In any event the minimum current through the VR tube will occur when the associated circuit is taking maximum current. This minimum current requirement is 5 ma. for all types of gaseous-type voltage-regulator tubes.

Other types of voltage-regulation systems, in addition to VR tubes, exhibit the added

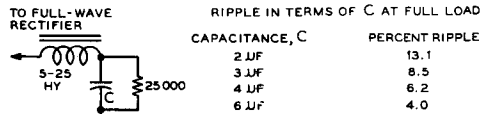

FIGURE 2

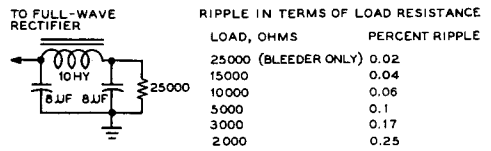

FIGURE 3

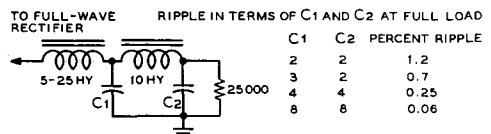

FIGURE 4

characteristic of offering a low value of ripple across their output terminals. The electronic-type of voltage-regulated power supply is capable of delivering an extremely small value of ripple across its output terminals, even though the rectifier-filter system ahead of the regulator delivers a relatively high value of ripple, such as in the vicinity of 5 to 10 per cent. In fact, it is more or less self evident that the better the regulation of such a supply, the better will be its ripple characteristic. It must be remembered that the ripple output of a voltage-regulated power supply of any type will rise rapidly when the load upon the supply is so high that the regulator begins to lose control. This will occur in a supply of the electronic type when the voltage ahead of the series regulator tube falls below a value equal to the sum of the minimum drop across the tube at that value of current, plus the output voltage. In the case of a shunt regulator of the VR-tube type, the regulating effect will fail when the current through the VR tube falls below the usual minimum value of about 5 ma.

Calculation of Ripple Although figures 2, 3 and 4 give the value of ripple voltage for several more or less standard types of filter systems, it is often of value to be able to calculate the value of ripple voltage to be expected with a particular set of filter components. Fortunately, the approximate ripple percentage for normal values

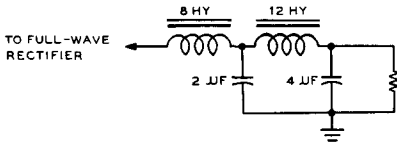

Figure 5
SAMPLE FILTER FOR
CALCULATION OF RIPPLE

of filter components may be calculated with the aid of rather simple formulas. In the two formulas to follow it is assumed that the line frequency is 60 cycles and that a full wave or a full-wave bridge rectifier is being used. For the case of a single-section choke-input filter as illustrated in figure 2, or for the ripple at the output of the first section of a two-section choke input filter the equation is as follows,

$$\text{Per cent ripple} = \frac{118}{LC-1}$$

where LC is the product of the input choke inductance in henrys (at the operating current to be used) and the capacitance which follows this choke expressed in microfarads.

In the case of a two-section filter, the per cent ripple at the output of the first section is determined by the above formula. Then this percentage is multiplied by the filter reduction factor of the following section of filter. This reduction factor is determined through the use of the following formula:

$$\text{Filter reduction factor} = \frac{LC-1}{1.76}$$

Where LC again is the product of the inductance and capacitance of the filter section. The reduction factor will turn out to be a decimal value, which is then multiplied by the percentage ripple obtained from the use of the preceding formula.

As an example, take the case of the filter diagrammed in figure 5. The LC product of the first section is 16. So the ripple to be expected at the output of the first section will be: $118/(16-1)$ or $118/15$, which gives 7.87 per cent. Then the second section, with an LC product of 48, will give a reduction factor of: $1.76/(48-1)$ or $1.76/47$ or 0.037. Then the ripple percentage at the output of the total filter will be: 7.87 times 0.037 or slightly greater than 0.29 per cent ripple.

Resistance-Capacitance Filters In many applications where the current drain is relatively small, so that the voltage drop across the series resistors would not be

excessive, a filter system made up of resistors and capacitors only may be used to advantage. In the normal case, where the reactance of the shunting capacitor is very much smaller than the resistance of the load fed by the filter system, the ripple reduction per section is equal to $1/(2\pi RC)$. In terms of the 120-cycle ripple from a full-wave rectifier the ripple-reduction factor becomes: $1.33/RC$ where R is expressed in thousands of ohms and C in microfarads. For 60-cycle ripple the expression is: $2.66/RC$ with R and C in the same quantities as above.

Filter System Resonance Many persons have noticed, particularly when using an input choke followed by a 2- μ fd.

first filter capacitor, that at some value of load current the power supply will begin to hum excessively and the rectifier tubes will tend to flicker or one tube will seem to take all the load while the other tube dims out. If the power supply is shut off and then again started, it may be the other tube which takes the load; or first one tube and then the other will take the load as the current drain is varied. This condition, as well as other less obvious phenomena such as a tendency for the first filter capacitor to break down regardless of its voltage rating or for rectifier tubes to have short life, results from *resonance* in the filter system following the high-voltage rectifier.

The condition of resonance is seldom encountered in low-voltage power supplies since the capacitors used are usually high enough so that resonance does not occur. But in high-voltage power supplies, where both choke inductance and filter capacitance are more expensive, the condition of resonance happens frequently. The product of inductance and capacitance which resonates at 120 cycles is 1.77. Thus a 1- μ fd. capacitor and a 1.77 henry choke will resonate at 120 cycles. In almost any normal case the LC product of any section in the filter system will be somewhat greater than 1.77, so that resonance at 120 cycles will seldom take place. But the LC product for resonance at 60 cycles is about 7.1. This is a value frequently encountered in the input section of a high-voltage power supply. It occurs with a 2- μ fd. capacitor and a choke which has 3.55 henrys of inductance at some current value. With a 2- μ fd. filter capacitor following this choke, resonance will occur at the current value which causes the inductance of the choke to be 3.55 henrys. When this resonance does occur, one rectifier tube (assuming mercury-

vapor types) will dim and the other will become much brighter.

Thus we see that we must avoid the LC products of 1.77 and 7.1. With a swinging-type input choke, whose inductance varies over a 5-to-1 range, we see that it is possible for resonance to occur at 60 cycles at a low value of current drain, and then for resonance to occur at 120 cycles at approximately full load on the power supply. Since the LC product must certainly be greater than 1.77 for satisfactory filtering along with peak-current limitation on the rectifier tubes, we see that with a swinging-type input choke the LC product must still be greater than 7.1 at maximum current drain from the power supply. To allow a reasonable factor of safety, it will be well to keep the LC product at maximum current drain above the value 10.

From the above we see that we can just get by with a 2- μ fd. first capacitor following the input choke when this choke is of the more-or-less standard 5-25 henry swinging variety. Some of the less expensive types of chokes swing from about 3 to 12 henrys, so we see that the first capacitor must be greater than 2 μ fd. to avoid resonance with these chokes. A 3- μ fd. capacitor may be used if available, but a standard 4- μ fd. unit will give a greater safety factor.

32-2 Rectification Circuits

There are a large number of rectifier circuits that may be used in the power supplies for station equipment. But the simpler circuits are more satisfactory for the power levels up to the maximum permitted the radio amateur. Figure 6 shows the three most common circuits used in power supplies for amateur equipment.

Half-Wave Rectifiers A half-wave rectifier, as shown in figure 6A, passes one half of the wave of each cycle of the alternating current and blocks the other half. The output current is of a *pulsating* nature, which can be smoothed into pure, direct current by means of filter circuits. Half-wave rectifiers produce a pulsating current which has zero output during one-half of each a-c cycle; this makes it difficult to filter the output properly into d.c. and also to secure good voltage regulation for varying loads.

Full-Wave Rectifiers A full-wave rectifier consists of a pair of half-wave rectifiers working on opposite halves of the cycle, connected in such a manner that each

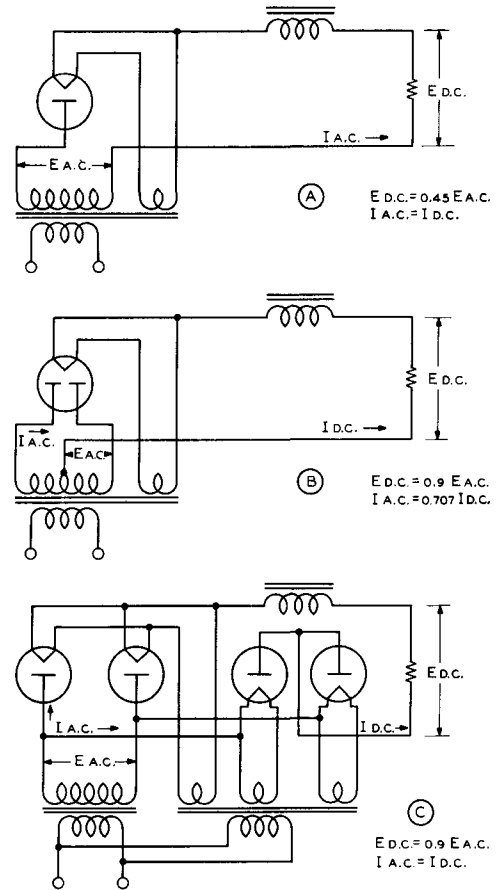

Figure 6
MOST COMMON RECTIFIER CIRCUITS

(A) shows a half-wave rectifier circuit, (B) is the standard full-wave rectifier circuit used with a dual rectifier or two rectifier tubes, and (C) is the bridge rectifier circuit.

half of the rectified a-c wave is combined in the output as shown in figure 7. This pulsating unidirectional current can be filtered to any desired degree, depending upon the particular application for which the power supply is designed.

A full-wave rectifier may consist of two plates and a filament, either in a single glass or metal envelope for low-voltage rectification or in the form of two separate tubes, each having a single plate and filament for high-voltage rectification. The plates are connected across the high-voltage a-c power transformer winding, as shown in figure 6B. The power transformer is for the purpose of transforming the 110-volt a-c line supply to the desired second-

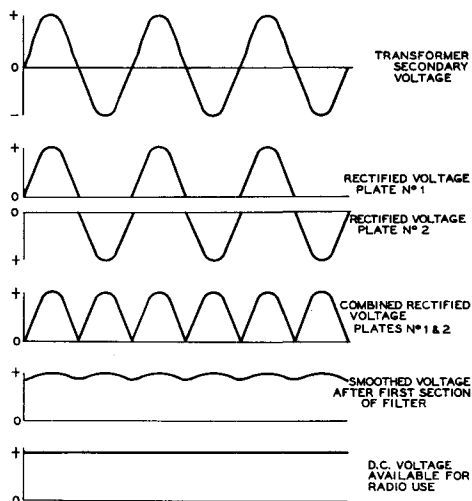

Figure 7

FULL-WAVE RECTIFICATION

Showing transformer secondary voltage, the rectified output of each tube, the combined output of the rectifier, the smoothed voltage after one section of filter, and the substantially pure d.c. output of the rectifier-filter after additional sections of filter.

ary a-c voltages for filament and plate supplies. The transformer delivers alternating current to the two plates of the rectifier tube; one of these plates is positive at any instant during which the other is negative. The center point of the high-voltage transformer winding is usually grounded and is, therefore, at zero voltage, thereby constituting the negative B connection.

While one plate of the rectifier tube is conducting, the other is inoperative, and vice versa. The output voltages from the rectifier tubes are connected together through the common rectifier filament circuit. Thus the plates alternately supply pulsating current to the output (load) circuit. The rectifier tube filaments or cathodes are always positive in polarity with respect to the plate transformer in this type of circuit.

The output current pulsates 120 times per second for a full-wave rectifier connected to a 60-cycle a-c line supply; hence the output of the rectifier must pass through a filter to smooth the pulsations into direct current. Filters are designed to select or reject alternating currents; those most commonly used in a-c power supplies are of the *low-pass* type. This means that pulsating currents which have a frequency below the cutoff frequency of the filter will pass through the filter to the load.

Direct current can be considered as alternating current of zero frequency; this passes through the low-pass filter. The 120-cycle pulsations are similar to alternating current in characteristic, so that the filter must be designed to have a *cutoff* at a frequency *lower than 120 cycles* (for a 60 cycle a-c supply).

Bridge Rectification The *bridge rectifier* (figure 6C) is a type of full-wave circuit in which four rectifier elements or tubes are operated from a single high-voltage winding on the power transformer.

While twice as much output voltage can be obtained from a bridge rectifier as from a center-tapped circuit, the permissible output current is only one-half as great for a given power transformer. In the bridge circuit, four rectifiers and three filament heating transformer windings are needed, as against two rectifiers and one filament winding in the center-tapped full-wave circuit. In a bridge rectifier circuit, the inverse peak voltage impressed on any one rectifier tube is halved, which means that tubes of lower peak inverse voltage rating may be used for a given voltage output.

32-3 Standard Power Supply Circuits

Choke input is shown for all three of the standard circuits of figure 6, since choke input gives the best utilization of rectifier-tube and power transformer capability, and in addition gives much better regulation. Where greater output voltage is a requirement, where the load is relatively constant so that regulation is not of great significance, and where the rectifier tubes will be operated well within their peak-current ratings, the *capacitor-input* type of filter may be used.

The capacitor-input filter gives a no-load output voltage equal approximately to the peak voltage being applied to the rectifier tubes. At full-load, the d-c output voltage is usually slightly above one-half the secondary a-c voltage of the transformer, with the normal values of capacitance at the input to the filter. With large values of input capacitance, the output voltage will run somewhat higher than the r-m-s secondary voltage applied to the tubes, but the peak current flowing through the rectifier tubes will be many times as great as the d-c output current of the power supply. The half-wave rectifier of figure 6A is commonly used with capacitor input and resistance-capacitance filter as a high-voltage supply for a cathode-ray tube. In this case the current drain

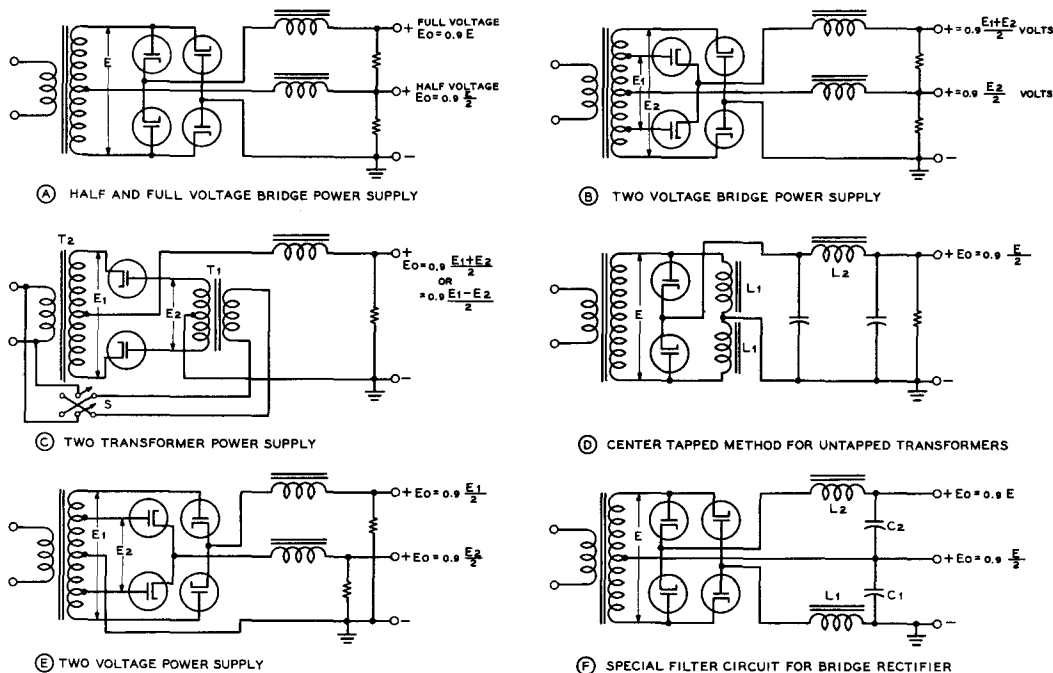

Figure 8
SPECIAL SINGLE-PHASE RECTIFICATION CIRCUITS

A description of the application and operation of each of these special circuits is given in the accompanying text.

is very small so that the peak-current rating of the rectifier tube seldom will be exceeded.

The circuit of figure 6B is most commonly used in medium-voltage power supplies since this circuit is the most economical of filament transformers, rectifier tubes and sockets, and space. But the circuit of figure 6C, commonly called the *bridge rectifier*, gives better transformer utilization so that the circuit is most commonly used in higher powered supplies. The circuit has the advantage that the entire secondary of the transformer is in use at all times, instead of each side being used alternately as in the case of the full-wave rectifier. As a point of interest, the current flow through the secondary of the plate transformer is a substantially pure a-c wave as a result of better transformer utilization, instead of the pulsating d-c wave through each half of the power transformer secondary in the case of the full-wave rectifier.

The circuit of figure 6C will give the greatest value of output power for a given transformer weight and cost in a single-phase power supply as illustrated. But in attempting to bridge-rectify the whole secondary of a trans-

former designed for a *full-wave* rectifier, in order to obtain doubled output voltage, make sure that the insulation rating of the transformer to be used is adequate. In the bridge rectifier circuit the center of the high-voltage winding is at a d-c potential of one-half the total voltage output from the rectifier. In a normal full-wave rectifier the center of the high-voltage winding is grounded. So in the bridge rectifier the entire high-voltage secondary of the transformer is subjected to twice the peak-voltage stress that would exist if the same transformer were used in a full-wave rectifier. High-quality full-wave transformers will withstand bridge operation quite satisfactorily so long as the total output voltage from the supply is less than perhaps 4500 volts. But inexpensive transformers, whose insulation is just sufficient for full-wave operation, will break down when bridge rectification of the entire secondary is attempted.

Special Single-Phase Rectification Circuits

Figure 8 shows six circuits which may prove valuable when it is desired to obtain more than

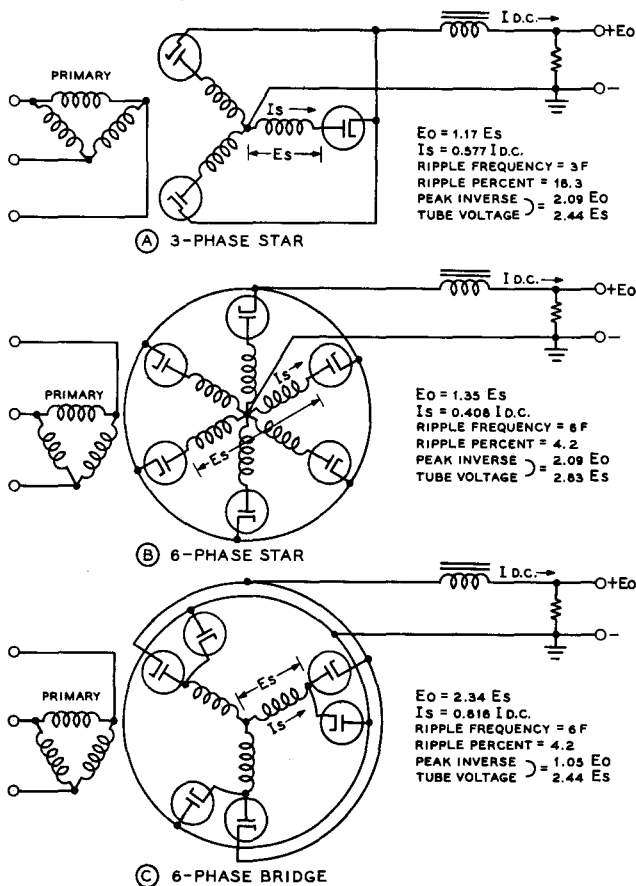

Figure 9
COMMON
POLYPHASE-
RECTIFICATION
CIRCUITS

These circuits are used when polyphase power is available for the plate supply of a high-power transmitter. The circuit at (B) is also called a three-phase full-wave rectification system. The circuits are described in the accompanying text.

one output voltage from one plate transformer or where some special combination of voltages is required. Figure 8A shows a more or less common method for obtaining full voltage and half voltage from a bridge rectification circuit. With this type of circuit separate input chokes and filter systems are used on both output voltages. If a transformer designed for use with a full-wave rectifier is used in this circuit, the current drain from the full-voltage tap is doubled and added to the drain from the half-voltage tap to determine whether the rating of the transformer is being exceeded. Thus if the transformer is rated at 1250 volts at 500 ma. it will be permissible to pull 250 ma. at 2500 volts with no drain from the 1250-volt tap, or the drain from the 1250-volt tap may be 200 ma. if the drain from the 2500-volt tap is 150 ma., and so forth.

Figure 8B shows a system which may be convenient for obtaining two voltages which are not in a ratio of 2 to 1 from a bridge-type rectifier; a transformer with taps along the

winding is required for the circuit however. With the circuit arrangement shown the voltage from the tap will be greater than one-half the voltage at the top. If the circuit is changed so that the plates of the two rectifier tubes are connected to the outside of the winding instead of to the taps, and the cathodes of the other pair are connected to the taps instead of to the outside, the total voltage output of the rectifier will be the same, but the voltage at the tap position will be *less* than half the top voltage.

An interesting variable-voltage circuit is shown in figure 8C. The arrangement may be used to increase or decrease the output voltage of a conventional power supply, as represented by transformer T_1 , by adding another filament transformer to isolate the filament circuits of the two rectifier tubes and adding another plate transformer between the filaments of the two tubes. The voltage contribution of the added transformer T_2 may be subtracted from or added to the voltage produced by T_1 .

simply by reversing the double-pole double-throw switch S. A serious disadvantage of this circuit is the fact that the entire secondary winding of transformer T_2 must be insulated for the total output voltage of the power supply.

An arrangement for operating a full-wave rectifier from a plate transformer not equipped with a center tap is shown in figure 8D. The two chokes L_1 must have high inductance ratings at the operating current of the plate supply to hold down the a-c current load on the secondary of the transformer since the *total* peak voltage output of the plate transformer is impressed across the chokes alternately. However, the chokes need only have half the current rating of the filter choke L_2 for a certain current drain from the power supply since only half the current passes through each choke. Also, the two chokes L_1 act as input chokes so that an additional swinging choke is not required for such a power supply.

A conventional two-voltage power supply with grounded transformer center tap is shown in figure 8E. The output voltages from this circuit are separate and not additive as in the circuit of figure 8B. Figure 8F is of advantage when it is desired to operate Class B modulators from the half-voltage output of a bridge power supply and the final amplifier from the full voltage output. Both L_1 and L_2 should be swinging chokes but the total drain from the power supply passes through L_1 while only the drain of the final amplifier passes through L_2 . Capacitors C_1 and C_2 need be rated only half the maximum output voltage of the power supply, plus the usual safety factor. This arrangement is also of advantage in holding down the "key-up" voltage of a c-w transmitter since both L_1 and L_2 are in series, and their inductances are additive, insofar as the "critical inductance" of a choke-input filter is concerned. If 4 μ f. capacitors are used at both C_1 and C_2 adequate filter will be obtained on both plate supplies for hum-free radiophone operation.

Polyphase Rectification Circuits It is usual practice in commercial equipment installations when the power drain from a plate supply is to be greater than about one kilowatt to use a *polyphase rectification system*. Such power supplies offer better transformer utilization, less ripple output and better power factor in the load placed upon the a-c line. However, such systems require a source of three-phase (or two-phase with Scott connection) energy. Several of the

more common polyphase rectification circuits with their significant characteristics are shown in figure 9. The increase in ripple frequency and decrease in percentage of ripple is apparent from the figures given in figure 9. The circuit of figure 9C gives the best transformer utilization as does the bridge circuit in the single-phase connection. The circuit has the further advantage that there is no average d-c flow in the transformer, so that three single-phase transformers may be used. A tap at half-voltage may be taken at the junction of the star transformers, but there will be d-c flow in the transformer secondaries with the power supply center tap in use. The circuit of figure 9A has the disadvantage that there is an average d-c flow in each of the windings.

Rectifiers Rectifying elements in high-voltage plate supplies are almost invariably electron tubes of either the high-vacuum or mercury-vapor type, although selenium or silicon rectifier stacks containing a large number of elements are often used. Low-voltage high-current supplies may use argon gas rectifiers (Tungar tubes), selenium rectifiers, or other types of dry-disc rectification elements. The *xenon* rectifier tubes offer some advantage over mercury-vapor rectifiers for high-voltage applications where extreme temperature ranges are likely to be encountered. However, such rectifiers (3B25 for example) are considerably more expensive than their mercury-vapor counterparts.

Peak Inverse Voltage and Peak Plate Current In an a-c circuit, the maximum peak voltage or current is $\sqrt{2}$ or 1.41 times that indicated by the a-c meters in the circuit. The meters read the *root-mean-square* (r.m.s.) values, which are the peak values divided by 1.41 for a sine wave.

If a potential of 1,000 r.m.s. volts is obtained from a high-voltage secondary winding of a transformer, there will be 1,410-volts peak potential from the rectifier plate to ground. In a single-phase supply the rectifier tube has this voltage impressed on it, either positively when the current flows or "inverse" when the current is blocked on the other half-cycle. The *inverse peak voltage* which the tube will stand safely is used as a rating for rectifier tubes. At higher voltages the tube is liable to arc back, thereby destroying or damaging it. The relations between peak inverse voltage, total transformer voltage and filter output voltage depend upon the characteristics of the filter and rectifier circuits (whether full- or half-wave, bridge, single-phase or polyphase, etc.).

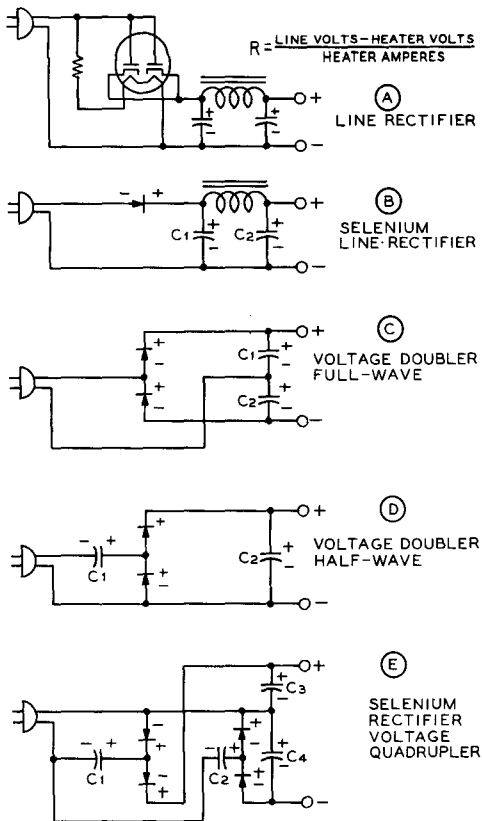

Figure 10

TRANSFORMERLESS POWER-SUPPLY CIRCUITS

Circuits such as shown above are also frequently called *line-rectifier circuits*. Selenium rectifiers, vacuum diodes, or gas diodes may be used as the rectifying elements in these circuits.

Rectifier tubes are also rated in terms of *peak plate current*. The actual direct load current which can be drawn from a given rectifier tube or tubes depends upon the type of filter circuit. A full-wave rectifier with capacitor input passes a peak current several times the direct load current.

In a filter with choke input, the peak current is not much greater than the load current if the inductance of the choke is fairly high (assuming full-wave rectification).

A full-wave rectifier with two rectifier elements requires a transformer which delivers twice as much a-c voltage as would be the case with a half-wave rectifier or bridge rectifier.

Mercury-Vapor Rectifier Tubes The inexpensive *mercury-vapor* type of rectifier tube is almost universally used in the high-voltage plate supplies of amateur and commercial transmitters. Most amateurs are quite familiar with the use of these tubes but it should be pointed out that when new or long-unused mercury-vapor tubes are first placed in service, the filaments should be operated at normal temperature for approximately twenty minutes before plate voltage is applied, in order to remove all traces of mercury from the cathode and to clear any mercury deposits from the top of the envelope. After this preliminary warm-up with a new tube, plate voltage may be applied within 20 to 30 seconds after the time the filaments are turned on, each time the power supply is used. If plate voltage should be applied before the filament is brought to full temperature, active material may be knocked from the oxide-coated filament and the life of the tube will be greatly shortened.

Small r-f chokes must sometimes be connected in series with the plate leads of mercury-vapor rectifier tubes in order to prevent the generation of radio-frequency hash. These r-f chokes must be wound with sufficiently heavy wire to carry the load current and must have enough inductance to attenuate the r-f parasitic noise current to prevent it from flowing in the filter supply leads and then being radiated into nearby receivers. Manufactured mercury-vapor rectifier hash chokes are available in various current ratings from the *James Millen Company* in Malden, Mass., and from the *J. W. Miller Company* in Los Angeles.

When mercury-vapor rectifier tubes are operated in parallel in a power supply, small resistors or small iron-core choke coils should be connected in series with the plate lead of each tube. These resistors or inductors tend to create an equal division of plate current between parallel tubes and prevent one tube from carrying the major portion of the current. When high vacuum rectifiers are operated in parallel, these chokes or resistors are not required.

Transformerless Power Supplies Figure 10 shows a group of five different types of *transformerless power supplies* which are operated directly from the a-c line. Circuits of the general type are normally found in a.c.-d.c. receivers but may be used in low-powered exciters and in test instruments. When circuits such as shown in (A) and (B) are operated directly from the a-c line, the rec-

tifier element simply rectifies the line voltage and delivers the alternate half cycles of energy to the filter network. With the normal type of rectifier tube, load currents up to approximately 75 ma. may be employed. The d-c voltage output of the filter will be slightly less than the r-m-s line voltage, depending upon the particular type of rectifier tube employed. With the introduction of the miniature selenium rectifier, the transformerless power supply has become a very convenient source of moderate voltage at currents up to perhaps 500 ma. A number of advantages are offered by the selenium rectifier as compared to the vacuum tube rectifier. Outstanding among these are the factors that the selenium rectifier operates instantly, and that it requires no heater power in order to obtain emission. The amount of heat developed by the selenium rectifier is very much less than that produced by an equivalent vacuum-tube type of rectifier.

In the circuits of figure 10 (A), (B) and (C), capacitors C_1 and C_2 should be rated at approximately 150 volts and for a normal degree of filtering and capacitance, should be between 15 to 60 μ fd. In the circuit of figure 10D, capacitor C_1 should be rated at 150 volts and capacitor C_2 should be rated at 300 volts. In the circuit of figure 10E, capacitors C_1 and C_2 should be rated at 150 volts and C_3 and C_4 should be rated at 300 volts.

The d-c output voltage of the line rectifier may be stabilized by means of a VR tube. However, due to the unusually low internal resistance of the selenium rectifier, transformerless power supplies using this type of rectifying element can normally be expected to give very good regulation.

Voltage-Doubler Circuits Figures 10C and 10D illustrate two simple voltage-doubler circuits which will deliver a d-c output voltage equal approximately to twice the r-m-s value of the power line voltage. The no-load d-c output voltage is equal to 2.82 times the r-m-s line voltage value. At high current levels, the output voltage will be slightly under twice the line voltage. The circuit of figure 10C is of advantage when the lowest level of ripple is required from the power supply, since its ripple frequency is equal to twice the line frequency. The circuit of figure 10D is of advantage when it is desired to use the grounded side of the a-c line in a permanent installation as the return circuit for the power supply. However, with the circuit of figure 10D the ripple frequency is the same as the a-c line frequency.

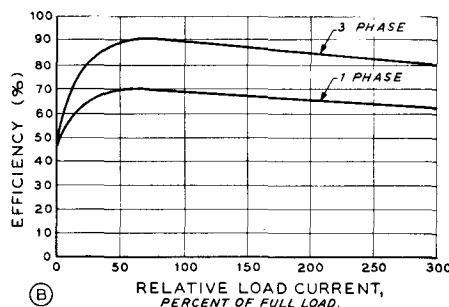
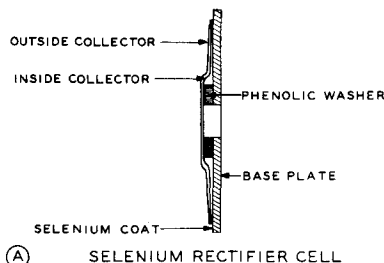

Figure 11

THE SELENIUM RECTIFIER

- A—The selenium rectifier is a semi-conductor stack built up of nickel plated aluminum discs coated on one side with selenium alloy.
- B—Rectifier efficiency is high, reaching 70% for single phase service, dropping slightly at high current densities.

Voltage Quadrupler The circuit of figure 10E illustrates a voltage quadrupler circuit for miniature selenium rectifiers. In effect this circuit is equivalent to two voltage doublers of the type shown in figure 10D with their outputs connected in series. The circuit delivers a d-c output voltage under light load approximately equal to four times the r-m-s value of the line voltage. The no-load d-c output voltage delivered by the quadrupler is equal to 5.66 times the r-m-s line voltage value and the output voltage decreases rather rapidly as the load current is increased.

In each of the circuits in figure 10 conventional high-vacuum rectifiers may be substituted with their filaments connected in series and an appropriate value of the line resistor added in series with the filament string.

32-4 Selenium and Silicon Rectifiers

Selenium rectifiers are characterized by long life, dependability, and maintenance-free operation under severe operating conditions. The

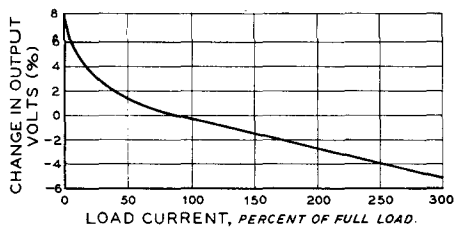

Figure 12
VOLTAGE REGULATION OF
SELENIUM CELL

This graph applies to single phase full wave bridge, and center-tap circuits which utilize both halves of the input wave. In single phase half wave circuits the regulation will be poorer.

selenium rectifier consists of a nickel-plated aluminum base plate coated with selenium over which a low temperature alloy is sprayed. The base plate serves as the negative electrode and the alloy as the positive, with current flowing readily from the base plate to the alloy but encountering high resistance in the opposite direction (figure 11A). This action results in effective rectification of an alternating input voltage and current with the efficiency of conversion dependent to some extent upon the ratio of the resistance in the conducting direction to that of the blocking direction. In normal power applications a ratio of 100 to 1 is satisfactory; however, special applications such as magnetic amplifiers often require ratios in the order of 1000 to 1.

The basic selenium rectifier cell is actually a diode capable of half wave rectification. Since many applications require full wave rectification for maximum efficiency and minimum ripple, a plurality of cells in series, parallel, or series-parallel combinations are stacked in an assembly.

Selenium rectifiers are operated over a wide range of voltages and currents. Typical applications range from a few volts at milliamperes of current to thousands of amperes at relatively high voltages.

The efficiency of high quality selenium rectifiers is high, usually in the order of 90% in three phase bridge circuits and 70% in single phase bridge circuits. Of particular interest is the very slight decrease in efficiency even at high current overloads (figure 11B).

Threshold Voltage and Aging A minimum voltage is required to permit a selenium rectifier to conduct in the forward direction. This voltage, commonly known as the *threshold voltage*, precludes the use of selenium rectifiers at ex-

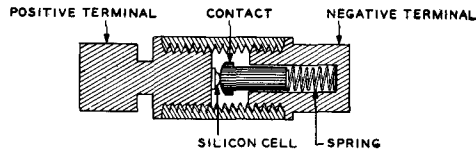

Figure 13
THE SILICON CELL

The common silicon rectifier is a pressure contact device capable of operation in ambient temperatures as high as 150°C. Heavy end ferrules that fit standard fuse clips are large enough to provide "heat sink" action. The positive ferrule is grooved to provide polarity identification and prevent incorrect mounting.

tremely low (less than one volt) applications. The threshold voltage will vary with temperature and will increase with a decrease in temperature.

Under operating conditions, and to a lesser extent when idle, the selenium rectifier will age. During the aging period the forward resistance will gradually increase, stabilizing at a new, higher value after about one year. This aging will result in approximately a 7% decrease in output voltage.

Voltage Regulation The selenium rectifier has extremely low internal impedance which exhibits non-linear characteristics with respect to applied voltage. This results in good voltage regulation even at large overload currents. Figure 12 shows that as the load is varied from zero to 300% of normal, the output voltage will change about 10%. It should be noted that because of non-linear characteristics, the voltage drop increases rapidly below 50% of normal load.

Silicon Rectifiers Of all recent developments in the field of semi-conductors, *silicon rectifiers* offer the most promising range of applications; from extreme cold to high temperature, and from a few watts of output power to very high voltage and currents. Inherent characteristics of silicon allow junction temperatures in the order of 200°C before the material exhibits intrinsic properties. This extends the operating range of silicon devices beyond that of any other efficient semi-conductor and the excellent thermal range coupled with very small size per watt of output power make silicon rectifiers applicable where other rectifiers were previously considered impractical.

Silicon Current Density The current density of a silicon rectifier is very high, and on present designs ranges

from 600 to 900 amperes per square inch of effective barrier layer. The usable current density depends upon the general construction of the unit and the ability of the heat sink to conduct heat from the crystal. The small size of the crystal is illustrated by the fact that a rectifier rated at 15 amperes d.c., and 150 amperes peak surge current has a total cell volume of only .00023 inches. Peak currents are extremely critical because the small mass of the cell will heat instantaneously and could reach failure temperatures within a time lapse of microseconds. The assembly of a typical silicon cell is shown in figure 13.

Operating Characteristics The reverse direction of a silicon rectifier is characterized by extremely high resistance, up to 10^9 ohms below a critical voltage point. This point of *avalanche voltage* is the region of a sharp break in the resistance curve, followed by rapidly decreasing resistance (figure 15A). In practice, the peak inverse working voltage is usually set at least 20% below the avalanche point to provide a safety factor.

The forward direction, or direction of low resistance determines the majority of power loss within the semi-conductor device. Figure 15B shows the static forward current characteristics versus applied voltage. The threshold voltage is about 0.6 volts.

Since the forward resistance of a semi-conductor is very low, any unbalance between threshold voltages or internal voltage drop would cause serious unbalance of load distribution and ultimate failure of the overloaded section. A small resistance should therefore be placed in series with each half wave section

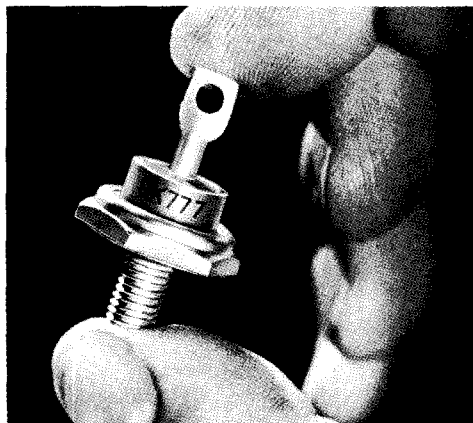

Figure 14
MINIATURE SEMI-CONDUCTOR TYPE RECTIFIER

Raytheon CK-777 power rectifier bolts to chassis to gain large "heat sink" area. Low internal voltage drop and high efficiency permit small size of unit.

operating in parallel to balance the load currents.

Some interesting and practical semi-conductor power supplies are shown in figure 16. Remember that the circuits of figure 16A and B, and those of figure 10 are "hot" with respect to one side of the power line.

32-5 100 Watt Mobile Power Supply

High efficiency and compact size are the most important factors in the design of mobile power supplies. The power package described in this section meets these stringent require-

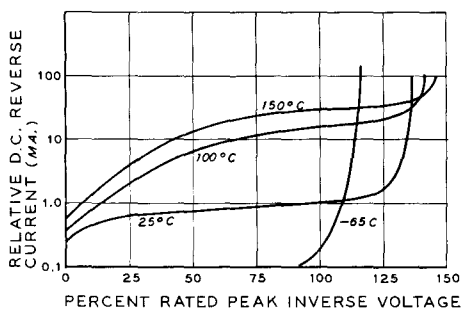

(A)

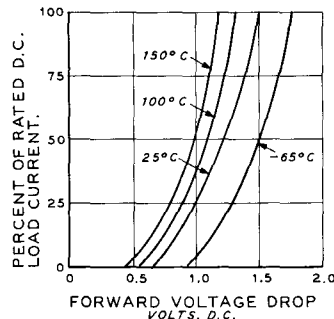

(B)

Figure 15

SILICON RECTIFIER CHARACTERISTICS

- A—Reverse direction of silicon rectifier is characterized by extremely high resistance up to point of avalanche voltage.
- B—Threshold voltage of silicon cell is about 0.6 volt. Once device starts conducting the current increases exponentially with small increments of voltage, then nearly linearly on a very steep slope.

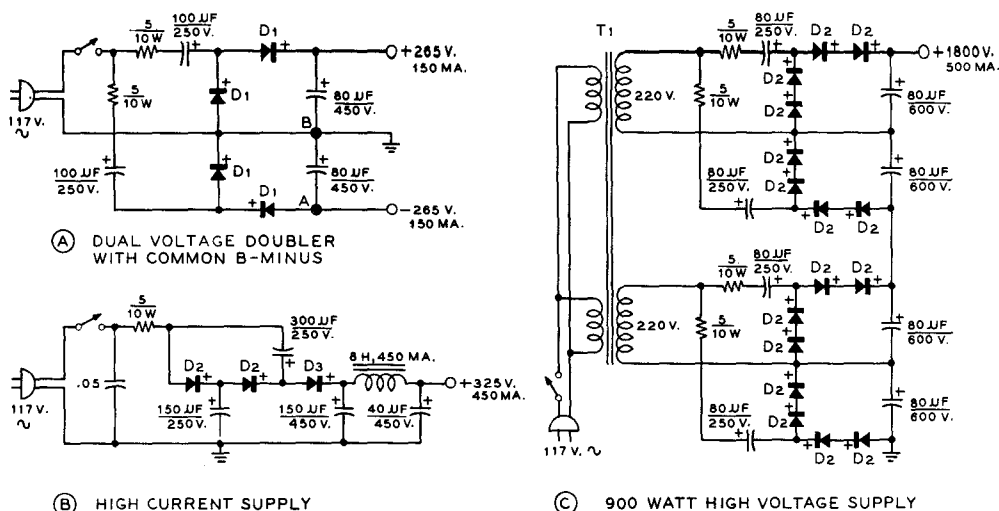

Figure 16
SEMI-CONDUCTOR POWER SUPPLIES

A—Voltage quadrupler circuit. If point "A" is taken as ground instead of point "B," supply will deliver 530 volts at 150 ma. from 115 volt a-c line. Supply is "hot" to line.

B—Voltage tripler delivering 325 volts at 450 ma. Supply is "hot" to line.

C—900 watt supply for sideband service may be made from two voltage quadruplers working in series from inexpensive "distribution-type" transformer. Supply features good dynamic voltage regulation.

PARTS LIST:

D₁—Sarkes Tarzian Model 150 selenium cell or Model M-500 silicon cell.

D₂—Sarkes Tarzian Model 500 selenium cell or Model M-500 silicon cell.

T₁—Power distribution transformer, used backwards. 230/460 primary, 115/230 secondary, 0.75 KVA. Chicago PCB-24750.

ments, delivering 100 watts at various voltages to run both the mobile transmitter and receiver. The input power required by the supply is almost directly proportional to the output power drain, and only a small amount of power is wasted to actuate the vibrator reeds.

The large demand for efficient and powerful mobile radio equipment has led to the development of new heavy-duty, vibrator-type power supply components; these are used to advantage in this unique design.

The Split-Reed Vibrator

The new *split-reed dual-interrupter vibrator* overcomes the power capacity limitations of the older type vibrators. In addition, this vibrator permits the design of power supplies requiring no component changes for operation from either the 6- or 12-volt d.c. power systems with which most automobiles are equipped.

Until recently, the majority of vibrator supplies have been designed around the synchronous type vibrator. A simplified diagram of such a vibrator is shown in figure 18A. One set of vibrator contacts switches the battery current alternately through two opposed primary windings of a transformer, thus inducing

a square-wave a.c. voltage in the secondary. This a.c. secondary voltage is then rectified by a second set of contacts on the vibrator armature. The limitations of this circuit are low power handling capacity and the need to use a different number of turns on the transformer primary when the battery voltage is changed from six to twelve volts.

In the split-reed vibrator (figure 18B), two sets of double-throw contacts are electrically isolated from each other. Each set has much greater current carrying capacity than the synchronous vibrator. However, a power transformer having two center-tapped primary windings is required. One set of contacts switches the d.c. power alternately between halves of one primary winding, and the other set simultaneously switches the other winding. Therefore, the primaries can be connected in parallel for 6-volt operation, or in series for 12-volt operation. No wiring changes are needed in the supply if the battery is properly connected to the power input terminals.

The Selenium Rectifier System

A selenium rectifier system is employed in this supply. Since the vibrator contacts open and close abruptly, the periodically in-

Figure 17
100 WATT MOBILE
POWER SUPPLY

This high efficiency mobile supply features 6 or 12 volt input, and will completely power both the mobile transmitter and receiver. 450, 300, and 240 volts are available. At right is control box for complete mobile system. Overall size of supply is only 6"x6"x6".

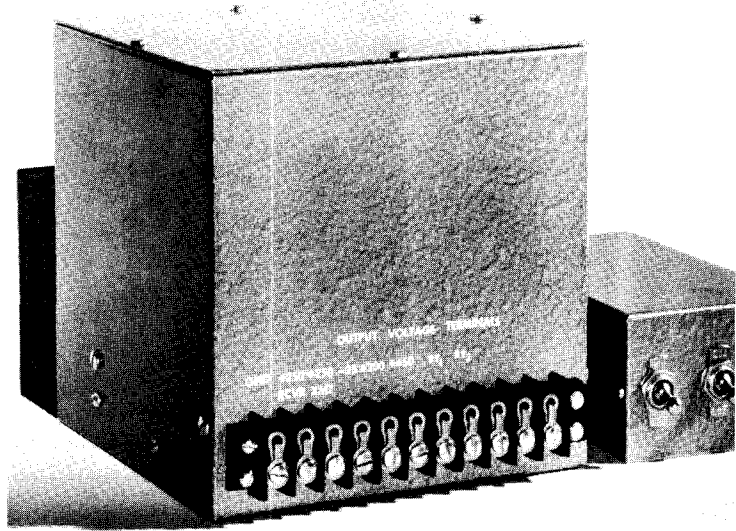

interrupted voltage impressed on the transformer primary has practically a square waveform. The secondary voltage also has nearly a square waveform as a result and thus the peak voltage on the rectifiers is only slightly higher than the average voltage of the waveform. This means that the rectifiers in a vibrator-type power supply can be operated on a square wave voltage close to their maximum peak inverse voltage rating, instead of considerably below this rating, as when a sine wave a.c. voltage is applied to them.

Power Supply Circuit This power supply has three high voltage sections as shown in figure 19. The 250 volt receiver supply is shown in figure 19A, the 300 volt low voltage transmitter supply in figure 19B, and the 450 volt high voltage transmitter supply is shown in figure 19C.

Note that each rectifier has two sections. The part numbers correspond to the markings shown in the complete schematic of figure 20. In the 250 volt circuit, the full transformer secondary voltage is applied to a full wave rectifier consisting of half of rectifiers SR₁ and SR₂. These two rectifiers form a common portion of all three rectifier circuits. The junction of the two rectifiers is grounded and the positive 250 volt output is taken from the center-tap transformer lead. This is the opposite of the usual full wave rectifier circuit.

The 300 volt d.c. output is obtained from a bridge rectifier circuit (figure 19B) consisting of one-half of SR₁ and SR₂ in the ground legs, plus SR₃ in the two bridge legs from which the positive voltage is obtained.

Another bridge rectifier circuit is employed for the 450 volt d.c. output, again with the

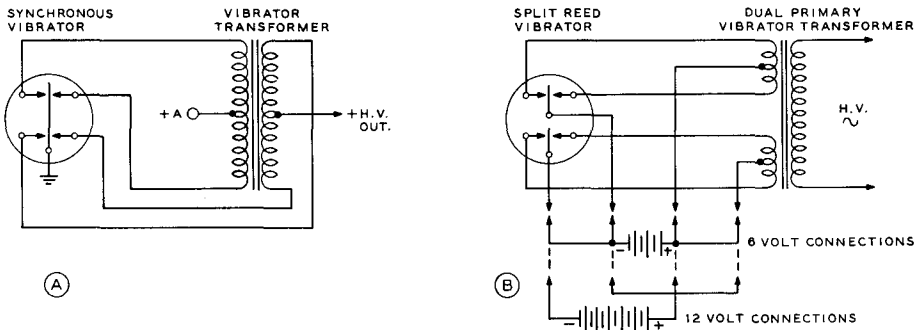

Figure 18
SUPPLY FEATURES THE NEW SPLIT-REED VIBRATOR CAPABLE OF HANDLING
100 WATTS OF POWER AT EITHER 6 OR 12 VOLTS

A—Simplified diagram of typical synchronous vibrator and rectifier circuit.
B—Simplified diagram of typical split-reed vibrator and 6 - 12 volt d-c. changeover system.

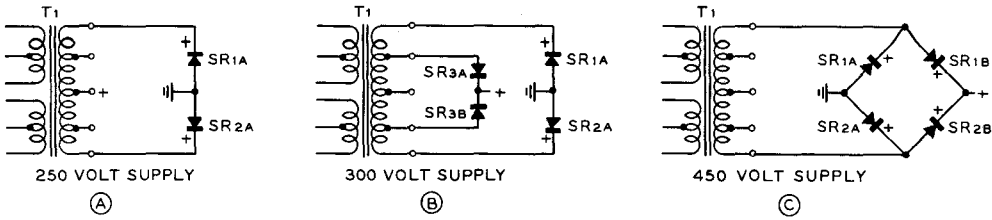

Figure 19
SIMPLIFIED CIRCUITS OF RECTIFIER SYSTEMS USED IN HIGH EFFICIENCY MOBILE SUPPLY

A—Full wave, 250 volt rectifier.
 B—300 volt bridge circuit tapped across portion of the high voltage winding.
 C—450 volt bridge rectifier circuit.

two grounded legs of the circuit passing through SR₁ and SR₂. The other two sections of these rectifiers form the legs of the bridge from which the positive d.c. voltage is taken.

Since there is little ripple voltage in the d.c. output from the rectifiers, a single 40 μ fd. filter capacitor on the 300 volt section of the supply is adequate. Two 100 μ fd. capacitors are placed in series across the 450 volt section and a capacitor input filter is employed for the low voltage section.

The Control Circuit A "push-to-talk" power switching circuit is included in the power supply so that the 250 volt output may be applied to a mobile receiver or converter. This is accomplished with one pair of contacts on a d.p.d.t. relay, RY₁, which also turns on the 300 volt output to a transmitter exciter when its relay coil is energized. A second d.p.d.t. relay, RY₂, turns on the 450 volt output to a transmitter final amplifier and modulator when its coil is energized. It also provides a power-reducing feature when the coil is not energized by applying 300 volts to the 450 volt output terminal and 250 volts to the 300 volt output terminal.

Since all rectifiers have high voltage on them continuously when the supply is operating, the idling current flow through the unused rectifiers when receiving is reduced to almost zero by disconnecting them from the filter capacitors and bleeder resistors by the action of the relays.

A special 20 volt secondary winding on the transformer provides transmitter negative bias through rectifier SR₄ and a 50 μ fd. filter capacitor.

Circuit Details—Low Voltage Section In this power supply, changing from 6- to 12-volt operation is accomplished with a 12-pin *Cinch-Jones* type 300 power plug and socket, P₁ and J₁, respectively.

A separate low voltage input cable is used for each voltage as shown in figure 20. Leads from P₁ to the main power relay RY₃ should be made as short as possible to reduce the voltage drop. This is particularly important with a six volt power source, where a cable resistance of only 0.04 ohm will cause a one volt primary drop when the power supply is operating at full load.

The six volt input plug connects the alternate pairs of vibrator contacts and the halves of the transformer primary windings in parallel. These units are connected in series for twelve volt operation as shown in figure 18B. Six volts for the relay coils is supplied from the power cable through pin 6 on J₁. With the twelve volt plug, a voltage dropping resistor, R₁, is connected in series with the relay coils. If the power supply is to be operated exclusively from the higher primary voltage, relays having twelve volt coils should be used, thus eliminating R₁.

There usually is sparking at the vibrator contacts so various capacitors and resistors are incorporated in the primary circuit to suppress any radio noise generated by vibrator action. These components are placed close to the pins of the vibrator socket.

Component Parts The heart of this power supply is the vibrator transformer designed specially for two-way mobile radio equipment. It is readily available from many of the 3000 *General Electric Co.* mobile radio service stations, or it may be ordered from the address given in the parts list of figure 20.

Power Supply Construction All components except the power transformer are enclosed inside a 6"x6"x6" aluminum utility box for maximum protection against dirt and dust. A sub-chassis made from 1/16-

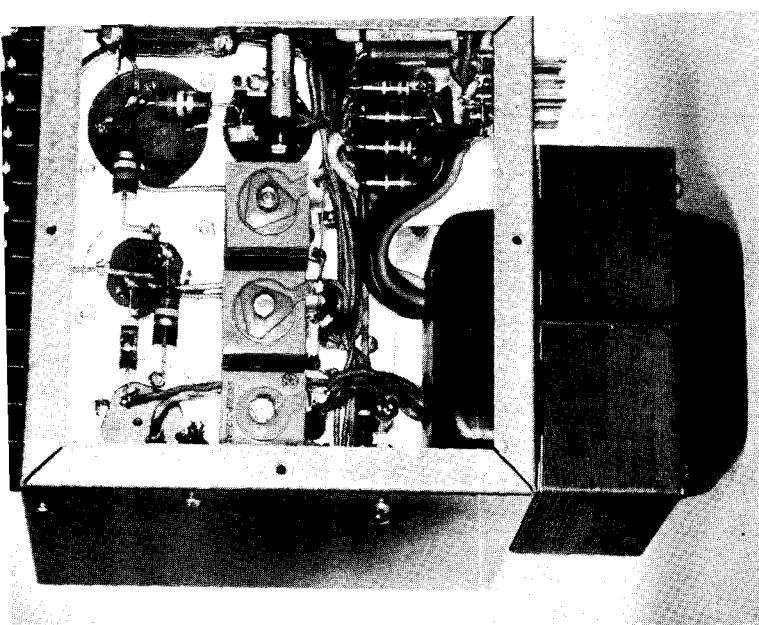

Figure 21
UNDER-CHASSIS
VIEW OF
POWER SUPPLY

The vibrator socket is hidden by the resistors and disc ceramic capacitors of the hash filter. R-F choke L_1 and the 25 $\mu\text{fd.}$ capacitors are above these parts on the wall of the case. Resistor R_1 is mounted to the wall, with SR_1 , SR_2 , and SR_3 in line below it.

chassis. The can of this capacitor is more than 200 volts "above ground" and should be insulated with a fibre sleeve.

The large seven pin socket into which the vibrator plugs should have two soldering lugs placed under each mounting bolt for the bypass capacitors which are later wired to the socket pins. If the power supply is to be mounted with the chassis in a vertical plane, pins 1 and 4 of the vibrator socket should be in a vertical plane. The smaller components below the chassis should not be installed until parts above the chassis have been assembled and wired.

The transformer primary leads are wired to the input plug and vibrator socket with shortest possible leads before other parts are wired. Placement of the under-chassis parts may be seen in figure 21. Layout of the parts is not critical.

Testing the Supply After the wiring has been checked, the power supply should be checked at half input voltage, but with full voltage applied to the vibrator coil. This is done by temporarily removing the jumper between pins 7 and 8 on the twelve volt power plug, P1. Pin 8 is then

Figure 22
TOP VIEW OF
POWER SUPPLY
INTERIOR

Relays RY_1 and RY_2 are at center above choke L_1 . Power transformer T_1 is mounted on end of cabinet. Across top of chassis (left to right) are vibrator and filter capacitors

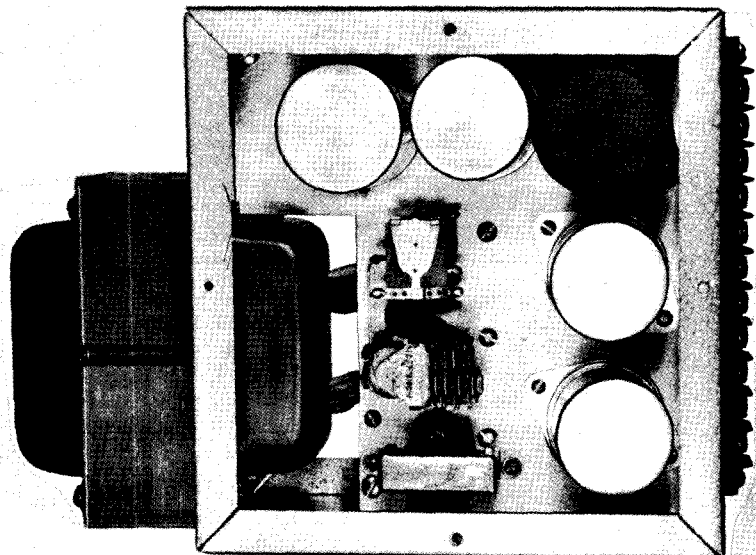

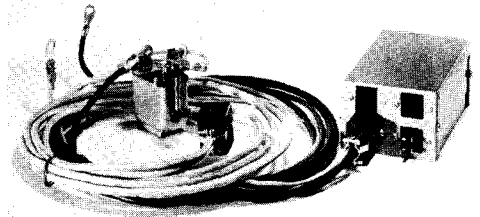
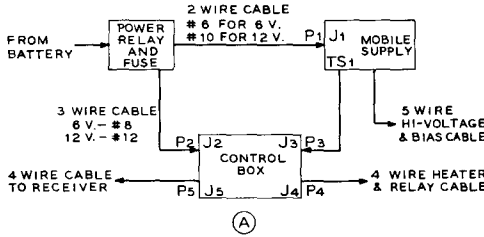
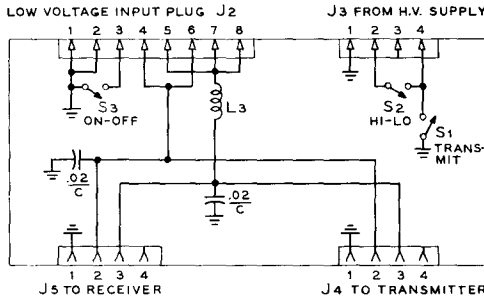

Figure 24
CABLE HARNESS, MAIN POWER RELAY, RY₃, AND REAR OF POWER CONTROL BOX

High voltage for the receiver, plus the control switch circuits for RY₁ and RY₂, are brought into the control box from the power supply through J₃.

High voltage leads for the transmitter are run directly from the supply, but the transmitter heater power and "transmit-receive" control circuit is run to the transmitter through control box circuit J₁ (figure 23A).



(B)

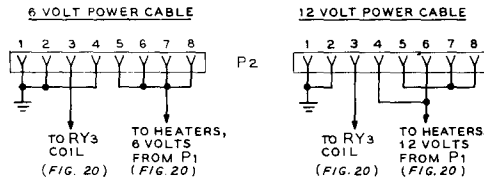

(C)

Figure 23
CONTROL WIRING

A—Block diagram of suggested power and control cables and switching system for mobile power supply.

B—Schematic diagram of suggested control box including power plugs for changing heaters for 6 or 12 volt operation. S₁ is "transmit-receive" switch, S₂ is "high-low" switch, and S₃ is main power switch for RY₃.

C—6 and 12 volt power cables.

any hash still present during reception. Every experienced "mobileer" will agree that noise in each mobile installation usually must be eliminated on a "search and filter" basis.

Installation in the Car This power supply may be operated in conjunction with the suggested configuration shown in figure 23A. Note that a separate cable is recommended for the heater power circuit to reduce vibrator hash pickup, and to minimize heater voltage variations when the supply is switched from receive to transmit.

Provision has been made for changing the mobile receiver and transmitter power circuits for either six or twelve volt operation as shown in the schematic of the control box in figure 23B. An eight contact plug and socket automatically make the proper connections when the six or twelve volt plug is attached.

32-6 Transistorized Power Supplies

The vibrator type of mobile supply achieves an overall efficiency in the neighborhood of 70%. The vibrator may be thought of as a mechanical switch reversing the polarity of the primary source at a repetition rate of 120 transfers per second. The switch is actuated by a magnetic coil and breaker circuit requiring appreciable power which must be supplied by the primary source.

One of the principal applications of the transistor is in switching circuits. The transistor may be switched from an "off" condition to an "on" condition with but the ap-

jumped to pin 9. The cable is attached to J₁ on the supply and to a six volt power source. Approximately half the rated voltage should be measured at the output terminal strip if the supply has been properly wired.

Replace the original connections on the power plug and test the supply with full input voltage. A 2500 ohm, 100 watt resistor, or four 25 watt 115 volt lamp bulbs in series make a good load resistance. The output voltages should measure close to 450, 300, and 240 volts under load. Additional .02 microfarad bypass capacitors at RY₃, the output terminal strip, and the control box should eliminate

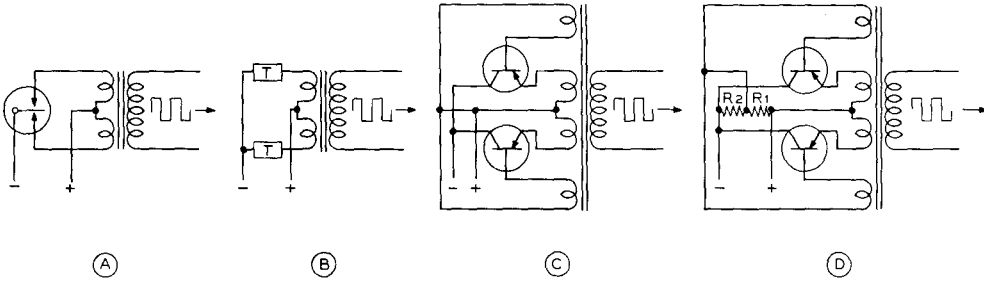

Figure 25

TRANSISTORS CAN REPLACE VIBRATOR IN MOBILE POWER SUPPLY SYSTEM

- A—Typical vibrator circuit.
- B—Vibrator can be represented by two single-pole single throw switches, or transistors.
- C—Push-pull square wave "oscillator" is driven by special feedback windings on power transformer.
- D—Addition of bias in base-emitter circuit results in oscillator capable of starting under full load.

plication of a minute exciting signal. When the transistor is nonconductive it may be considered to be an open circuit. When it is in a conductive state, the internal resistance is very low. Two transistors properly connected, therefore, can replace the single pole, double throw mechanical switch representing the vibrator. The transistor switching action is many times faster than that of the mechanical vibrator and the transistor can switch an appreciable amount of power. Efficiencies in the neighborhood of 95% can be obtained with 28 volt primary-type transistor power supplies, permitting great savings in primary power over conventional vibrators and dynamotors.

Transistor Operation The transistor operation resembles a magnetically coupled multi-vibrator, or an audio frequency push-pull square wave oscillator (figure 25C). A special feedback winding on the power trans-

former provides 180 degree phase shift voltage necessary to maintain oscillation. In this application the transistors are operated as on-off switches; i.e., they are either completing the circuit or opening it. The oscillator output voltage is a square wave having a frequency that is dependent upon the driving voltage, the primary inductance of the power transformer, and upon the peak collector current drawn by the conducting transistor. Changes in transformer turns, core area, core material, and feedback turns ratio have an effect on the frequency of oscillation. Frequencies in common use are in the range of 120 c.p.s. to 3,500 c.p.s.

The power consumed by the transistors is relatively independent of load. Loading the oscillator causes an increase in input current that is sufficient to supply the required power to the load and the additional losses in the transformer windings. Thus, the overall efficiency actually increases with load and is greatest at the heaviest load the oscillator will supply. A result of this is that an increase in load produces very little extra heating of the transistors. This feature means that it is impossible to burn out the transistors in the event of a shorted load since the switching action merely stops.

Transistor Power Rating The power capability of the transistor is limited by the amount of heat created by the current flow through the internal resistance of the transistor. When the transistor is conducting the internal resistance is extremely low and little heat is generated by current flow. Conversely, when the transistor is in a cut-off condition the internal resistance is very high and the current flow is extremely small. Thus, in both the "on" and "off" conditions

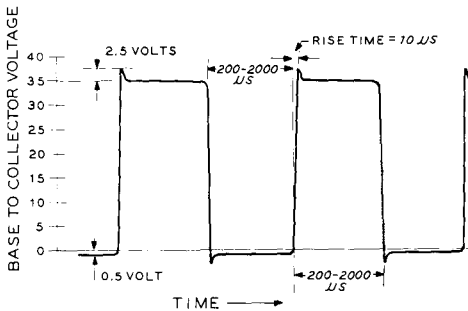

Figure 26
BASE-COLLECTOR WAVEFORM OF SWITCHING CIRCUIT, FOR 12 VOLT CIRCUIT

Square waveshape produces almost ideal switching action. Small "spike" on leading edge of pulses may be reduced by proper transformer design.

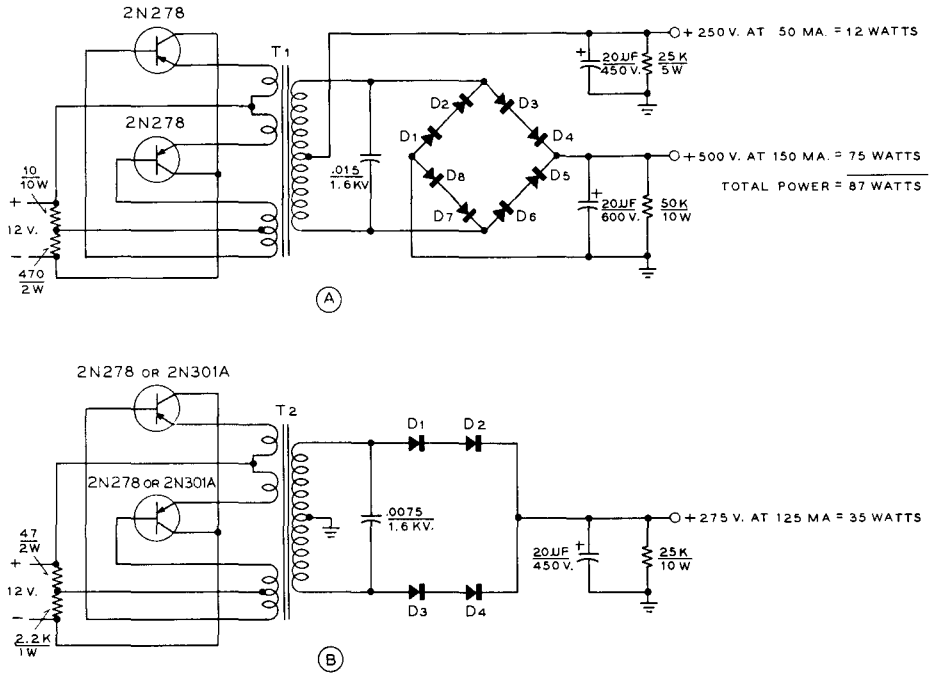

Figure 27

PRACTICAL TRANSISTOR POWER SUPPLIES

- T₁—Chicago DCT-2 transistor transformer
- T₂—Chicago DCT-1 transistor transformer
- D₁-D₆—Sarkes-Tarzian M-500 silicon rectifier or equivalent.

the transistor dissipates a minimum of power. The important portion of the operating cycle is that portion when the actual switching from one transistor to the other occurs, as this is the time during which the transistor may be passing through the region of high dissipation. The greater the rate of switching, in general, the faster will be the rise time of the square wave (figure 26) and the lower will be the internal losses of the transistor. The average transistor can switch about eight times the power rating of class A operation of the unit. Two switching transistors having 5 watt class A power output rating can therefore switch 80 watts of power when working at optimum switching frequency.

Self-Starting Oscillators The transistor supply shown in figure 25C is impractical because oscillations will not start under load. Base current of the proper polarity has to be momentarily introduced into the base-emitter circuit before oscillation will start and sustain itself. The addition of a bias resistor (figure 25D) to the circuit results

in an oscillator that is capable of starting under full load. R₁ is usually of the order of 10-50 ohms while R₂ is adjusted so that approximately 100 milliamperes flows through the circuit.

The current drawn from the battery by this network flows through R₂ and then divides between R₁ and the input resistances of the two transistors. The current flowing in the emitter-base circuit depends upon the value of input resistance. The induced voltage across the feedback winding of the transformer is a square wave of such polarity that it forward-biases the emitter-base diode of the transistor that is starting to conduct collector current, and reverse-biases the other transistor. The forward-biased transistor will have a very low input impedance, while the input impedance of the reversed-biased transistor will be quite high. Thus, most of the starting current drained from the primary power source will flow in R₁ and the base-emitter circuit of the forward-biased transistor and very little in the other transistor. It can be seen that R₁ must not be too low in comparison to the input re-

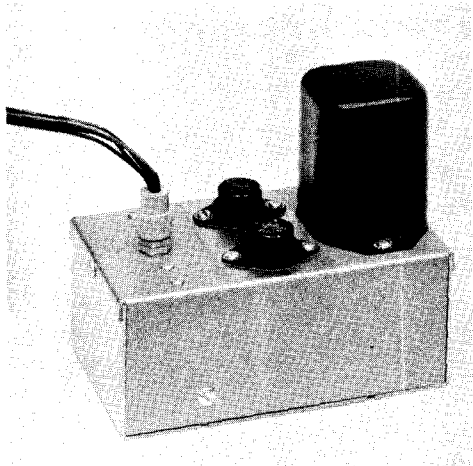

Figure 28
35 WATT TRANSISTOR
POWER SUPPLY

Two 2N301A power transistors are used in this midget supply. Transistors are mounted on sanded portion of chassis deck which acts as "heat sink." See text for details.

sistance of the conducting transistor, or else it will shunt too much current from the transistor. When switching takes place, the transformer polarities reverse and the additional current now flows in the base-emitter circuit of the other transistor.

The Power Transformer The power transformer in a transistor-type supply is designed to reach a state of maximum flux density (saturation) at the point of maximum transistor conductance. When this state is reached the flux density drops to zero and reduces the feedback voltage developed in the base winding to zero. The flux then reverses

because there is no conducting transistor to sustain the magnetizing current. This change of flux induces a voltage of the opposite polarity in the transformer. This voltage turns the first transistor off and holds the second transistor on. The transistor instantly reaches a state of maximum conduction, producing a state of saturation in the transformer. This action repeats itself at a very fast rate. Switching time is of the order of 5 to 10 microseconds, and saturation time is perhaps 200 to 2,000 microseconds. The collector waveform of a typical transistor supply is shown in figure 26. The rise time of the wave is about 5 microseconds, and the saturation time is 500 microseconds. The small "spike" at the leading edge of the pulse has an amplitude of about $2\frac{1}{2}$ volts and is a product of switching transients caused by the primary leakage reactance of the transformer. Proper transformer design can reduce this "spike" to a minimum value. An excessively large "spike" can puncture the transistor junction and ruin the unit.

32-7 Two Transistorized Mobile Supplies

The new *Chicago-Standard Transformer Co.* series of power transformers designed to work in transistor-type power supplies permits the amateur and experimenter to construct efficient mobile power supplies at a fraction of their former price. Described in this section are two power supplies designed around these efficient transformers. The smaller supply delivers 35 watts (275 volts at 125 milliamperes) and the larger supply delivers 85 watts (500 volts at 125 milliamperes and 250 volts

Figure 29
SCHEMATIC, TRANSISTOR
POWER SUPPLY FOR
12 VOLT AUTOMOTIVE
SYSTEM

T₁—Transistor power transformer, 12 volt primary, to provide 275 volts at 125 ma. Chicago Standard DCT-1.

D₁-D₄—Sarkes-Tarzian silicon rectifier, type M-500, or equivalent.

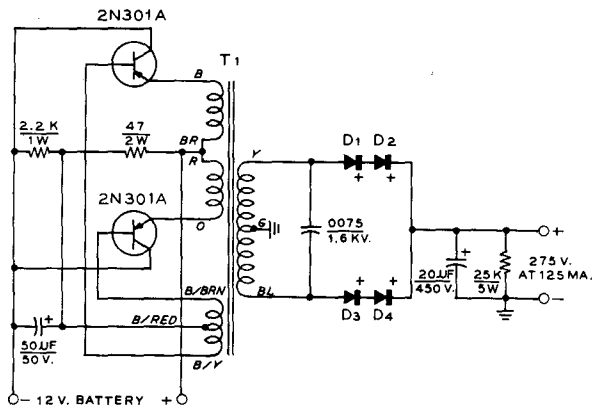

at 50 milliamperes, simultaneously). Both power units operate from a 12 volt primary source.

The 35 Watt Supply The 35 watt power unit uses two inexpensive RCA 2N301A

P-N-P-type power transistors for the switching elements and four silicon diodes for the high voltage rectifiers. The complete schematic is shown in figure 29. Because of the relatively high switching frequency only a single 20 μ fd. filter capacitor is required to provide pure d.c.

Regulation of the supply is remarkably good. No load voltage is 310 volts, dropping to 275 volts at maximum current drain of 125 milliamperes.

The complete power package is built upon an aluminum chassis-box measuring $5\frac{1}{4}$ "x 3"x2". Paint is removed from the center portion of the box to form a simple heat sink for the transistors. The box therefore conducts heat away from the collector elements of the transistors. The collector of the transistor is the metal case terminal and in this circuit is returned to the negative terminal of the primary supply. If the negative of the automobile battery is grounded to the frame of the car the case of the transistor may be directly grounded to the unpainted area of the chassis. If the positive terminal of the car battery is grounded it is necessary to electrically insulate the transistor from the aluminum chassis, yet at the same time permit a low *thermal* barrier to exist between the transistor case and the power supply chassis. A simple method of accomplishing this is to insert a thin mica sheet between the transistor and the chassis. "Two Mil" (.002") mica washers for transistors are available at many large radio supply houses. The mica is placed between the transistor and the chassis deck, and fibre washers are placed under the retaining nuts holding the transistor in place. When the transistors are mounted in place, measure the collector to ground resistance with an ohmmeter. It should be 100 megohms or higher in dry air. After the mounting is completed, spray the transistor and the bare chassis section with plastic *Krylon* to retard oxidation. Several manufacturers produce anodized aluminum washers that serve as mounting insulators. These may be used in place of the mica washers, if desired. The under-chassis wiring of the supply may be seen in figure 30.

The 85 Watt Supply Figure 31 shows the schematic of a dual voltage transistorized mobile power supply. A bridge

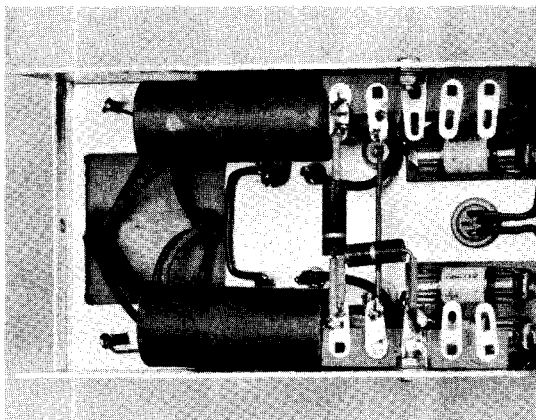

Figure 30
UNDER-CHASSIS LAYOUT OF PARTS

Two 10 μ fd. capacitors are connected in parallel for 20 μ fd. output filter capacitor. Silicon rectifiers are mounted in dual fuse clips at end of chassis. Transistors are insulated from chassis with thin mica sheets and fibre washers if supply is used with positive-grounded primary system.

rectifier permits the choice of either 250 volts or 500 volts, or a combination of both at a total current drain that limits the secondary power to 85 watts. Thus, 500 volts at 170 milliamperes may be drawn, with correspondingly less current as additional power is drawn from the 250 volt tap.

The supply is built upon an aluminum box-chassis measuring 7"x5"x3", the layout closely following that of the 35 watt supply. *Delco* 2N278 P-N-P-type transistors are used as the switching elements and eight silicon diodes form the high voltage bridge rectifier. The transistors are affixed to the chassis in the same manner as the 2N301A mounting described previously.

32-8 Power Supply Components

The usual components which make up a power supply, in addition to rectifiers which have already been discussed, are filter capacitors, bleeder resistors, transformers, and chokes. These components normally will be purchased especially for the intended application, taking into consideration the factors discussed earlier in this chapter.

Filter Capacitors There are two types of filter capacitors: (1) paper dielectric type, (2) electrolytic type.

Paper capacitors consist of two strips of metal foil separated by several layers of special

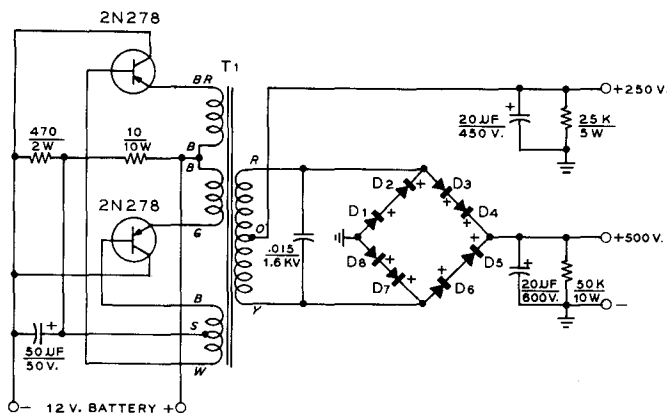

Figure 31
SCHEMATIC,
85 WATT
TRANSISTOR
POWER SUPPLY
FOR 12 VOLT
AUTOMOTIVE
SYSTEM

T₁—Transistor power transformer. 12 volt primary to provide 275 volts at 125 ma. Chicago Standard DCT-2.
D₁-D₄—Sarkes-Tarjian silicon rectifier, type M-500

paper. Some types of paper capacitors are wax-impregnated, but the better ones, especially the high-voltage types, are oil-impregnated and oil-filled. Some capacitors are rated both for *flash* test and normal operating voltages; the latter is the important rating and is the maximum voltage which the capacitor should be required to withstand in service.

The capacitor across the rectifier circuit in a capacitor-input filter should have a working voltage rating equal at least to 1.41 times the r-m-s voltage output of the rectifier. The remaining capacitors may be rated more nearly in accordance with the d-c voltage.

The *electrolytic capacitor* consists of two aluminum electrodes in contact with a conducting paste or liquid which acts as an *electrolyte*. A very thin film of oxide is formed on the surface of one electrode, called the *anode*. This film of oxide acts as the dielectric. The electrolytic capacitor must be correctly connected in the circuit so that the anode always is at a positive potential with respect to the electrolyte, the latter actually serving as the other electrode (plate) of the capacitor. A reversal of the polarity for any length of time will ruin the capacitor.

The dry type of electrolytic capacitor uses an electrolyte in the form of paste. The dielectric in electrolytic capacitors is not perfect; these capacitors have a much higher direct current leakage than the paper type.

The high capacitance of electrolytic capacitors results from the thinness of the film which is formed on the plates. The maximum voltage that can be safely impressed across the average electrolytic filter capacitor is between 450 and 600 volts; the working voltage is usually rated at 450. When electrolytic ca-

pacitors are used in filter circuits of high-voltage supplies, the capacitors should be connected in series. The positive terminal of one capacitor must connect to the negative terminal of the other, in the same manner as dry batteries are connected in series.

It is not necessary to connect shunt resistors across each electrolytic capacitor section as it is with paper capacitors connected in series, because electrolytic capacitors have fairly low internal d-c resistance as compared to paper capacitors. Also, if there is any variation in resistance, it is that electrolytic unit in the poorest condition which will have the highest leakage current, and therefore the voltage across this capacitor will be lower than that across one of the series connected units in better condition and having higher internal resistance. Thus we see that equalizing resistors are not only unnecessary across series-connected electrolytic capacitors but are actually undesirable. This assumes, of course, similar capacitors by the same manufacturer and of the same capacitance and voltage rating. It is *not advisable* to connect in series electrolytic capacitors of different make or ratings.

There is very little economy in using electrolytic capacitors in series in circuits where more than two of these capacitors would be required to prevent voltage breakdown.

Electrolytic capacitors can be greatly reduced in size by the use of etched aluminum foil for the anode. This greatly increases the surface area, and the dielectric film covering it, but raises the power factor slightly. For this reason, ultra-midget electrolytic capacitors ordinarily should not be used at full rated d-c voltage when a high a-c component is present,

such as would be the case for the input capacitor in a capacitor-input filter.

Bleeder Resistors A heavy duty resistor should be connected across the output of a filter in order to draw some load current at all time. This resistor avoids soaring of the voltage at no load when swinging choke input is used, and also provides a means for discharging the filter capacitors when no external vacuum-tube circuit load is connected to the filter. This *bleeder* resistor should normally draw approximately 10 per cent of the full load current.

The power dissipated in the bleeder resistor can be calculated by dividing the square of the d-c voltage by the resistance. This power is dissipated in the form of heat, and, if the resistor is not in a well-ventilated position, the wattage rating should be higher than the actual wattage being dissipated. High-voltage, high-capacitance filter capacitors can hold a dangerous charge if not bled off, and wire-wound resistors occasionally open up without warning. Hence it is wise to place carbon resistors in series across the regular wire-wound bleeder.

When purchasing a bleeder resistor, be sure that the resistor will stand not only the required wattage, but also the *voltage*. Some resistors have a voltage limitation which makes it impossible to force sufficient current through them to result in rated wattage dissipation. This type of resistor usually is provided with slider taps, and is designed for voltage divider service. An untapped, non-adjustable resistor is preferable as a high voltage bleeder, and is less expensive. Several small resistors may be connected in series, if desired, to obtain the required wattage and voltage rating.

Transformers Power transformers and filament transformers normally will give no trouble over a period of many years if purchased from a reputable manufacturer, and if given a reasonable amount of care. Transformers must be kept dry; even a small amount of moisture in a high-voltage unit will cause quick failure. A transformer which is operated continuously, within its ratings, seldom will give trouble from moisture, since an economically designed transformer operates at a moderate temperature rise above the temperature of the surrounding air. But an unsealed transformer which is inactive for an appreciable period of time in a highly humid location can absorb enough moisture to cause early failure.

Filter Choke Coils Filter inductors consist of a coil of wire wound on a laminated iron core. The size of wire is determined by the amount of direct current which is to flow through the choke coil. This direct current magnetizes the core and reduces the inductance of the choke coil; therefore, filter choke coils of the *smoothing* type are built with an air gap of a small fraction of an inch in the iron core, for the purpose of preventing saturation when maximum d.c. flows through the coil winding. The "air gap" is usually in the form of a piece of fiber inserted between the ends of the laminations. The air gap reduces the initial inductance of the choke coil, but keeps it at a higher value under maximum load conditions. The coil must have a great many more turns for the same initial inductance when an air gap is used.

The d-c resistance of any filter choke should be as low as practicable for a specified value of inductance. Smaller filter chokes, such as those used in radio receivers, usually have an inductance of from 6 to 15 henrys, and a d-c resistance of from 200 to 400 ohms. A high d-c resistance will reduce the output voltage, due to the voltage drop across each choke coil. Large filter choke coils for radio transmitters and Class B amplifiers usually have less than 100 ohms d-c resistance.

32-9 Special Power Supplies

A complete transmitter usually includes one or more power supplies such as grid-bias packs, voltage-regulated supplies, or transformerless supplies having some special characteristic.

Regulated Supplies—V-R Tubes Where it is desired in a circuit to stabilize the voltage supply to a load requiring not more than perhaps 20 to 25 ma., the glow-discharge type of voltage-regulator tube can be used to great advantage. Examples of such circuits are the local oscillator circuit in a receiver, the tuned oscillator in a v-f-o, the oscillator in a frequency meter, or the bridge circuit in a vacuum-tube voltmeter. A number of tubes are available for this application including the OA3/VR75, OB3/VR90, OC3/VR105, OD3/VR150, and the OA2 and OB2 miniature types. These tubes stabilize the voltage across their terminals to 75, 90, 105, or 150 volts. The miniature types OA2 stabilize to 150 volts and OB2 to 108 volts. The types OA2, OB2 and OB3/VR90

have a maximum current rating of 30 ma. and the other three types have a maximum current rating of 40 ma. The minimum current required by all six types to sustain a constant discharge is 5 ma.

A *VR tube* (common term applied to all glow-discharge voltage regulator tubes) may be used to stabilize the voltage across a variable load or the voltage across a constant load fed from a varying voltage. Two or more VR tubes may be connected in series to provide exactly 180, 210, 255 volts or other combinations of the voltage ratings of the tubes. It is not recommended, however, that VR tubes be connected in parallel since both the striking and the regulated voltage of the paralleled tubes normally will be sufficiently different so that only one of the tubes will light. The remarks following apply generally to all the VR types although some examples apply specifically to the OD3/VR150 type.

A device requiring say, only 50 volts can be stabilized against *supply voltage* variations by means of a VR-105 simply by putting a suitable resistor in series with the regulated voltage and the load, dropping the voltage from 105 to 50 volts. However, it should be borne in mind that under these conditions the device will *not* be regulated for *varying load*; in other words, if the *load resistance* varies, the voltage across the load will vary, even though the regulated voltage remains at 105 volts.

To maintain constant voltage across a *varying load resistance* there must be *no* series resistance between the regulator tube and the load. This means that the device must be operated exactly at one of the voltages obtainable by seriesing two or more similar or different VR tubes.

A VR-150 may be considered as a stubborn variable resistor having a range of from 30,000 to 5000 ohms and so intent upon maintaining a fixed voltage of 150 volts across its terminals that when connected across a voltage source having *very poor regulation* it will instantly vary its own resistance within the limits of 5000 and 30,000 ohms in an attempt to maintain the same 150 volt drop across its terminals when the supply voltage is varied. The theory upon which a VR tube operates is covered in an earlier chapter.

It is paradoxical that in order to do a good job of regulating, the regulator tube must be fed from a voltage source having poor regulation (high series resistance). The reason for this presently will become apparent.

If a high resistance is connected across the VR tube, it will not impair its ability to maintain a fixed voltage drop. However, if the load is made too low, a variable 5000 to 30,000 ohm shunt resistance (the VR-150) will not exert sufficient effect upon the resulting resistance to provide constant voltage except over a *very limited* change in supply voltage or load resistance. The tube will supply maximum regulation, or regulate the largest load, when the source of supply voltage has high internal or high series resistance, because a variation in the effective internal resistance of the VR tube will then have more controlling effect upon the load shunted across it.

In order to provide greatest range of regulation, a VR tube (or two in series) should be used with a series resistor (to effect a poorly regulated voltage source) of such a value that it will permit the VR tube to draw from 8 to 20 ma. under normal or average conditions of supply voltage and load impedance. For maximum control range, the series resistance should be not less than approximately 20,000 ohms, which will necessitate a source of voltage considerably in excess of 150 volts. However, where the supply voltage is limited, good control over a *limited range* can be obtained with as little as 3000 ohms series resistance. If it takes less than 3000 ohms series resistance to make the VR tube draw 15 to 20 ma. when the VR tube is connected to the load, then the supply voltage is not high enough for proper operation.

Should the current through a VR-150, VR-105, or VR-75 be allowed to exceed 40 ma., the life of the tube will be shortened. If the current falls below 5 ma., operation will become unstable. Therefore, the tube must operate within this range, and within the two extremes will maintain the voltage within 1.5 per cent. It takes a voltage excess of at least 10 to 15 per cent to "start" a VR type regulator; and to insure positive starting each time the voltage supply should preferably exceed the regulated output voltage rating about 20 per cent or more. This usually is automatically taken care of by the fact that if sufficient series resistance for good regulation is employed, the voltage impressed across the VR tube before the VR tube ionizes and starts passing current is quite a bit higher than the starting voltage of the tube.

When a VR tube is to be used to regulate the voltage applied to a circuit drawing *less than 15 ma.* normal or average current, the simplest method of adjusting the series resist-

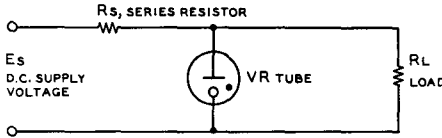

Figure 32
STANDARD VR-TUBE REGULATOR
CIRCUIT

The VR-tube regulator will maintain the voltage across its terminals constant within a few volts for moderate variations in R_L or E_S . See text for discussion of the use of VR tubes in various circuit applications.

ance is to remove the load and vary the series resistor until the VR tube draws about 30 ma. Then connect the load, and that is all there is to it. This method is particularly recommended when the load is a heater type vacuum tube, which may not draw current for several seconds after the power supply is turned on. Under these conditions, the current through the VR tube will never exceed 40 ma. even when it is running unloaded (while the heater tube is warming up and the power supply rectifier has already reached operating temperature).

Figure 32 illustrates the standard glow discharge regulator tube circuit. The tube will maintain the voltage across R_L constant to within 1 or 2 volts for moderate variations in R_L or E_S .

Voltage Regulated Power Supplies When it is desired to stabilize the potential across a circuit drawing more than a few milliamperes it is advisable to use a voltage-regulated power supply of the type illustrated in figure 33 rather than glow discharge tubes.

A 6AS7-G is employed as the series control element, and type 816 mercury vapor rectifiers are used in the power supply section. The 6AS7-G acts as a variable series resistance which is controlled by a separate regulator tube much in the manner of a-v-c circuits or inverse feedback as used in receivers and a-f amplifiers. A 6SH7 controls the operating bias on the 6AS7-G, and therefore controls the internal resistance of the 6AS7-G. This, in turn, controls the output voltage of the supply, which controls the plate current of the 6SH7, thus completing the cycle of regulation. It is apparent that under these conditions any change in the output voltage will tend to "resist itself," much as the a-v-c system of a receiver resists any change in signal strength delivered to the detector.

Because it is necessary that there always be a moderate voltage drop through the 6AS7-G in order for it to have proper control, the rest of the power supply is designed to deliver as much output voltage as possible. This calls for a low resistance full-wave rectifier, a high capacitance output capacitor in the filter system and a low resistance choke.

Reference voltage in the power supply is obtained from a VR-150 gaseous regulator. Note that the 6.3-volt heater winding for the 6SH7 and the 6AS7-G tubes is operated at a potential of plus 150 volts by connecting the winding to the plate of the VR-150. This procedure causes the heater-cathode voltage of the 6SH7 to be zero, and permits an output voltage of up to 450 since the 300-volt heater-to-cathode rating of the 6AS7-G is not exceeded with an output voltage of 450 from the power supply.

The 6SH7 tube was used in place of the more standard 6SJ7 after it was found that the regulation of the power supply could be improved by a factor of two with the 6SH7 in place of the 6SJ7. The original version of the power supply used a 5R4-GY rectifier tube in place of the 816's which now are used. The excessive drop of the 5R4-GY resulted in loss of control by the regulator por-

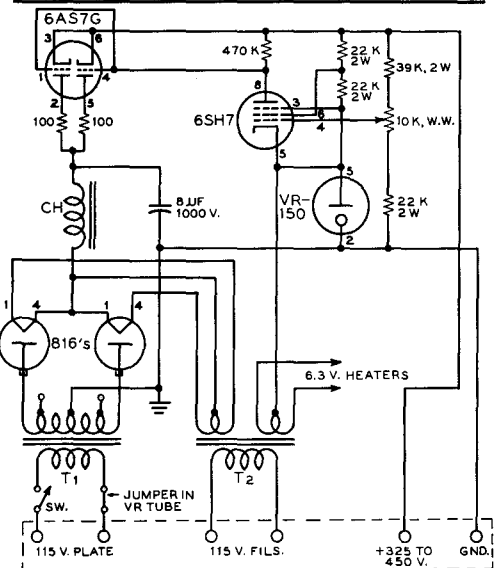
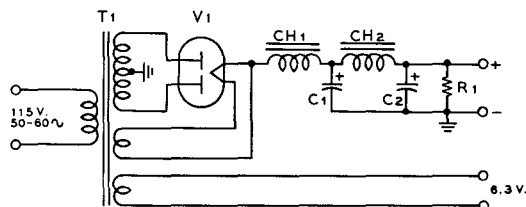

Figure 33
SCHEMATIC OF VOLTAGE
REGULATED POWER SUPPLY
T₁—615 or 520 volts each side of c.t., 300 ma. Stancor P-8041.
T₂—5 volts at 3 amp., 6.3 volts at 6 amp. Stancor P-5009.
CH—4 henry at 250 ma. Stancor C-1412.



COMPONENTS							APPROXIMATE OUTPUT VOLTAGE		MAX. CURRENT	6.3 V. FILAMENT
T ₁	V ₁	CH ₁	CH ₂	C ₁	C ₂	R ₁	NO LOAD	FULL LOAD		
350-0-350 STANCOR PC-8409 MERIT P-3152	5Y3-GT	10 H. STANCOR C-1001 MERIT C-2993	10 H. STANCOR C-1001 MERIT C-2993	10 JF, 450 V. CORNELL- DUBILIER BR-1045	20 JF, 450 V. CORNELL- DUBILIER BR-2045	35K, 10W	310	240	80 MA.	3 A.
375-0-375 STANCOR PC-8411 MERIT P-2954	5Y3-GT	3-13 H. STANCOR C-1718 MERIT C-3187	7 H. STANCOR C-1421 MERIT C-3180	10 JF, 450 V. CORNELL- DUBILIER BR-1045	20 JF, 450 V. CORNELL- DUBILIER BR-2045	35K, 10W	330	230	140 MA.	4.5 A.
400-0-400 STANCOR PC-8413	5U4-G	2-12 H. STANCOR C-1402 MERIT C-3189	4 H. STANCOR C-1412 MERIT C-3192	10 JF, 450 V. CORNELL- DUBILIER BR-1045	10 JF, 450 V. CORNELL- DUBILIER BR-1045	35K, 10W	360	270	250 MA.	5 A.
525-0-525 UTC S-40	5U4-GB	5-25 H. UTC S-32	20 H. UTC S-31	10 JF, 600 V. MALLORY TC-92	10 JF, 600 V. MALLORY TC-92	35K, 10W	460	375	240 MA.	4 A.
600-0-600 UTC S-41	5R4-GY	5-25 H. UTC S-32	20 H. UTC S-31	8 JF, 600 V. SPRAGUE CR-86	8 JF, 600 V. SPRAGUE CR-86	35K, 25W	540	410	200 MA.	4 A.
900-0-900 UTC S-45	5R4-GY	5-25 H. UTC S-32	20 H. UTC S-31	4 JF, 1KV. SPRAGUE CR-41	8 JF, 1KV. SPRAGUE CR-81	50K, 25W	630	650	175 MA.	—

Figure 34
DESIGN CHART FOR CHOKE-INPUT POWER SUPPLIES

tion with an output voltage of about 390 with a 225-ma. drain. Satisfactory regulation can be obtained, however, at up to 450 volts if the maximum current drain is limited to 150 ma. when using a 5R4-GY rectifier. If the power transformer is used with the taps giving 520 volts each side of center, and if the maximum drain is limited to 225 ma., a type 83 rectifier may be used as the power supply rectifier. The 615-volt taps on the power transformer deliver a voltage in excess of the maximum ratings of the 83 tube. With the 83 in the power supply, excellent regulation may be obtained with up to about 420 volts output if the output current is limited to 225 ma. But with the 816's as rectifiers the full capabilities of all the components in the power supply may be utilized.

If the power supply is to be used with an output voltage of 400 to 450 volts, the full 615 volts each side of center should be applied to the 816's. However, the maximum plate dissipation rating of the 6AS7-G will be exceeded, due to the voltage drop across the tube, if the full current rating of 250 ma. is used with an output voltage below 400 volts. If the power supply is to be used with full output current at voltages below 400 volts the 520-volt taps on the plate transformer

should be connected to the 816's. Some variation in the output range of the power supply may be obtained by varying the values of the resistors and the potentiometer across the output. However, be sure that the total plate dissipation rating of 26 watts on the 6AS7-G series regulator is not exceeded at maximum current output from the supply. The total dissipation in the 6AS7-G is equal to the current through it (output current plus the current passing through the two bleeder strings) multiplied by the drop through the tube (voltage across the filter capacitor minus the output voltage of the supply).

32-10 Power Supply Design

Power supplies may either be of the choke input type illustrated in figure 34, or the capacitor input type, illustrated in figure 35. Capacitor input filter systems are characterized by a d-c supply output voltage that runs from 0.9 to about 1.3 times the r.m.s. voltage of one-half of the high voltage secondary winding of the transformer. The approximate regulation of a capacitor input filter system is shown in figure 36. Capacitor input filter systems are not recommended for use with

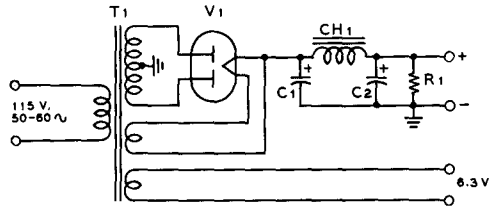

COMPONENTS						APPROXIMATE OUTPUT VOLTAGE		MAX. CURRENT	6.3 V. FILAMENT
T ₁	V ₁	CH ₁	C ₁	C ₂	R ₁	NO LOAD	FULL LOAD		
280-0-280 STANCOR PC-8404 MERIT P-3148	5Y3-GT	10 H. STANCOR C-1001 MERIT C-2993	20 μF, 450 V. CORNELL- DUBILIER BR-2045	20 μF, 450 V. CORNELL- DUBILIER BR-2045	35K,10W	340	240	80 MA.	3A.
375-0-375 STANCOR PC-8411 MERIT P-2954	5Y3-GT	7 H. STANCOR C-1421 MERIT C-3180	10 μF, 800 V. MALLORY TC-92	10 μF, 800 V. MALLORY TC-92	35 K,10W	480	350	125 MA.	4.5 A.
435-0-435 MERIT P-3156	5U4-G	4 H. STANCOR C-1412 MERIT C-3182	8 μF, 800 V. SPRAGUE CR-86	8 μF, 800 V. SPRAGUE CR-86	35K,25W	600	400	225 MA.	8 A.
600-0-600 STANCOR PC-8414	5R4-GY	4 H. STANCOR C-1412 MERIT C-3182	4 μF, 1 KV. SPRAGUE CR-41	8 μF, 1 KV. SPRAGUE CR-81	50K,25W	800	600	200 MA.	8 A.
900-0-900 UTC S-45	5R4-GY	20 H. UTC S-31	4 μF, 1.5 KV. SPRAGUE CR-415	8 μF, 1.5 KV. SPRAGUE CR-815	75K 25W	1200	910	150 MA.	—

Figure 35
DESIGN CHART FOR CAPACITOR-INPUT POWER SUPPLIES

mercury vapor rectifier tubes, as the peak rectifier current may run as high as five or six times the d-c load current of the power supply. It is possible, however, to employ type 872-A mercury vapor rectifier tubes in capacitor input circuits wherein the load current is less than 600 milliamperes or so, and where a low resistance bleeder is used to hold the minimum current drain of the supply to a value greater than 50 milliamperes or so. Under these conditions the peak plate current of the 872-A mercury vapor tubes will not be exceeded if the input filter capacitor is 4 μfd. or less.

Choke input filter systems are characterized by lower peak load currents (1.1 to 1.3 times the average load current) than the capacitor input filter, and by better voltage regulation. Design Charts for capacitor and choke input filter supplies for various voltages and load currents are shown in figures 34, 35, and 37.

The construction of power supplies for transmitters, receivers and accessory equipment is a relatively simple matter electrically since lead lengths and placement of parts are of minor importance and since the circuits themselves are quite simple. Under-chassis wiring of a heavy-duty supply is shown in figure 38.

Bridge Supplies Some practical variations of the common bridge rectifier

circuit of figure 6 are illustrated in figures 39 and 40. In many instances a transmitter or modulator requires two different supply voltages, differing by a ratio of about 2:1. A simple bridge supply such as shown in figure 39 will provide both of these voltages from a simple broadcast "replacement-type" power transformer. The first supply of figure 39 is ample to power a transmitter of the 6CL6-807 type to an input of 60 watts. The second supply will run a transmitter running up to 120 watts, such as one employing a pair of 6146

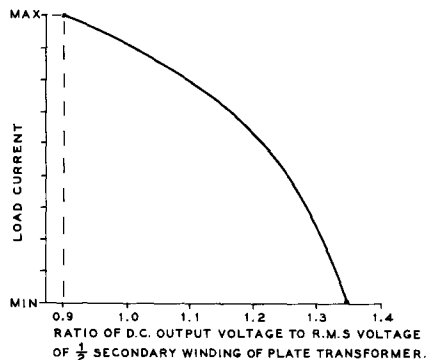
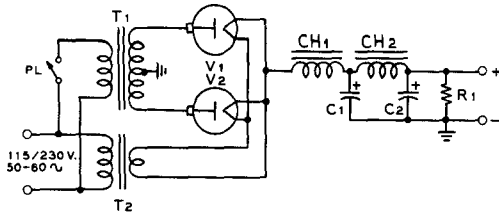

Figure 36
APPROXIMATE REGULATION OF CAPACITOR-INPUT FILTER SYSTEM



COMPONENTS								APPROXIMATE OUTPUT VOLTAGE		MAX. CURRENT (ICAS)
T1	T2	V1-V2	CH1	CH2	C1	C2	R1	NO LOAD	FULL LOAD	
1150-0-1150 CHICAGO TRANS. P-107	2.5V., 10A. CHI. TRAN. R-210	866-A 866-A	8 H. CHI. TRAN. R-63	10 H. CHI. TRAN. R-103	4UF, 1.5 KV. SANGAMO 7115-4	8UF, 1.5 KV. SANGAMO 7115-B	40K, 75 W	1150	1000	350 MA.
1710-0-1710 CHICAGO TRANS. P-1512	2.5V., 10A. CHI. TRAN. R-210H	866-A 866-A	8 H. CHI. TRAN. R-65	10 H. CHI. TRAN. R-105	4UF, 2 KV. SANGAMO 7120-4	8UF, 2 KV. SANGAMO 7120-B	50K, 75 W	1700	1500	425 MA.
2900-0-2900 CHICAGO TRANS. P-2126	5V., 10A. CHI. TRAN. R-310H	872-A 872-A	8 H. CHI. TRAN. R-67	8 H. CHI. TRAN. R-67	4UF, 3KV. SANGAMO 7130-4	4UF, 3KV. SANGAMO 7130-4	75 K 200 W	2750	2500	700 MA.
3500-0-3500 UTC CG-309	5V., 10A. UTC LS-82	872-A 872-A	10 H. UTC CG-1S	10 H. UTC CG-1S	4UF, 4KV. CORNELL- DUBILIER 740040-A	4UF, 4KV. CORNELL- DUBILIER 740040-A	100 K 200 W	3400	3000	1000 MA.
4600-0-4600 UTC CG-310 CHICAGO TRANS. P-4353	5V., 20A. UTC LS-83	575-A 575-A	10 H. UTC CG-1S	10 H. UTC CG-1S	4UF, 5KV. AEROVOX JP-09	4UF, 5KV. AEROVOX JP-09	100 K 300 W	4400	4000	800 MA.

Figure 37
DESIGN CHART FOR CHOKE-INPUT HIGH VOLTAGE SUPPLIES

tetrodes in the power amplifier stage. It is to be noted that separate filament transformers are used for rectifier tubes V_1 and V_2 , and that one leg of each filament is connected to the cathode of the respective tube, which is at a high potential with respect to ground. The choke CH_1 in the negative lead of the supply serves as a common filter choke for both output voltages. Each portion of the supply may be considered as having a choke input filter system. Filaments of V_1 should be energized before the primary voltage is applied to T_1 .

Bridge supplies may also be used to advantage to obtain relatively high plate voltages for high powered transmitting equipment. Type 866-A and 872-A rectifier tubes can only serve in a supply delivering under 3500 volts in a full-wave circuit. Above this voltage, the peak inverse voltage rating of the rectifier tube will be exceeded, and danger of flash-back within the rectifier tube will be present. However, with bridge circuits, the same tubes may deliver up to as much as 7000 volts d.c. without exceeding the peak inverse voltage rating.

The bridge circuit also permits the use of the so-called "pole transformer" in high voltage power supplies. Two KVA transformers of this type having a 110/220 volt secondary winding and a split 2200 volt primary winding may often be picked up in salvage yards for a dollar or two. If reversed, and either 110 or 220 volts applied to the "primary" winding approximately 2200 volts r.m.s. will be developed across the new "secondary" winding. If used in a bridge circuit as shown in

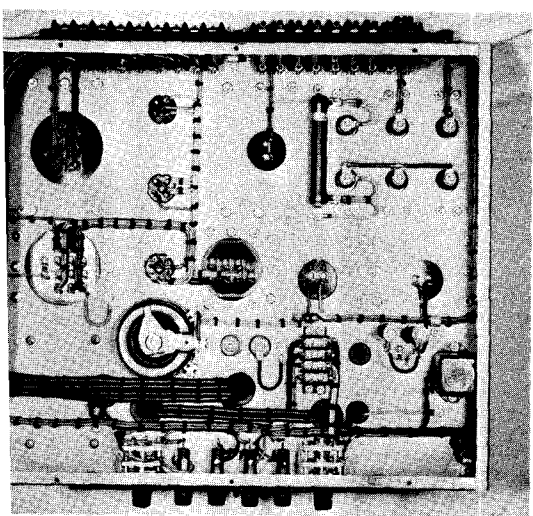

Figure 38
UNDER-CHASSIS POWER SUPPLY ASSEMBLY

All components are firmly mounted to the steel chassis and all wiring is cabled. High voltage leads are run in automobile ignition cables. Heavy-duty terminal strips are mounted along the rear edge of the chassis. The control panel of this supply is shown in figure 1 of this chapter.

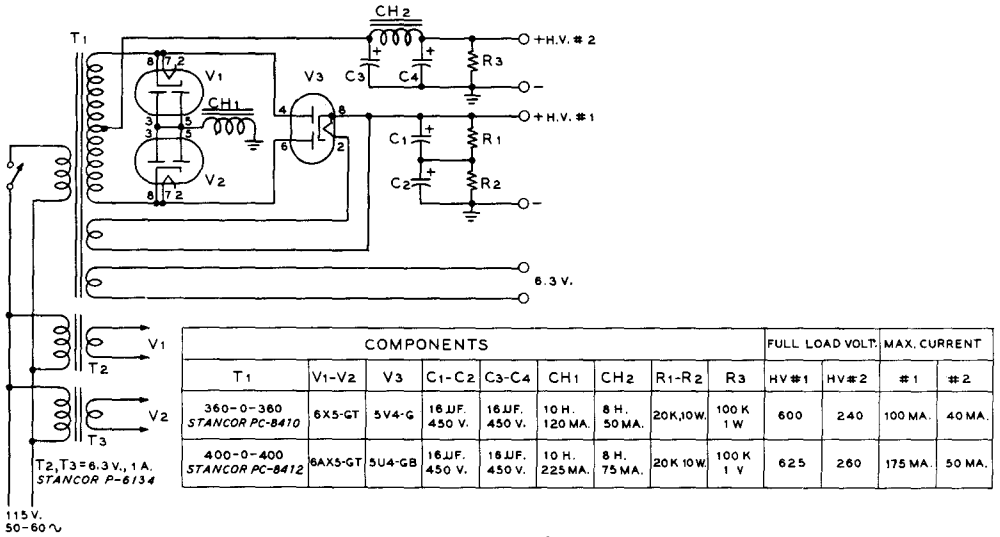

Figure 39
DUAL VOLTAGE BRIDGE POWER SUPPLIES

figure 40, a d-c supply voltage of about 1900 volts at a current of 500 milliamperes may be drawn from such a transformer. Do not attempt to use a smaller transformer than the 2-KVA rating, as the voltage regulation of the unit will be too poor for practical purposes.

For higher voltages, a pole transformer with a 4400 volt primary and a 110/220 volt secondary may be reversed to provide a d-c plate supply of about 3800 volts.

Commercial plate transformers intended for full wave rectifier service may also be used in bridge service *provided* that the insulation at the center-tap point of the high voltage winding is sufficient to withstand one-half of the r.m.s. voltage of the secondary winding. Many high voltage transformers are specifically designed for operation with the center-tap of the secondary winding at ground potential; consequently the insulation of the winding at this point is not designed to withstand high voltage. It is best to check with the manufacturer of the transformer and find out if the insulation will withstand the increased volt-

age before a full wave-type transformer is utilized in bridge rectifier service.

32-11 300 Volt, 50 Ma. Power Supply

There are many applications in the laboratory and amateur station for a simple low drain power supply. The most common appli-

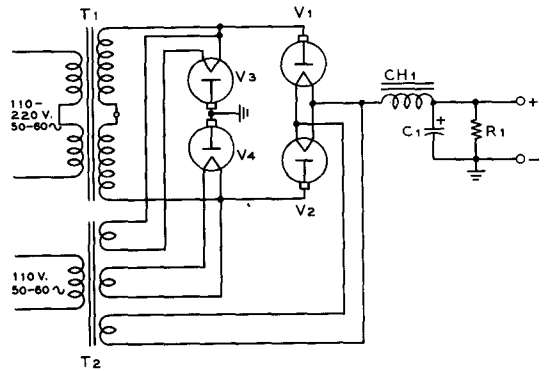

Figure 40
HIGH-VOLTAGE
POWER SUPPLY

COMPONENTS							FULL LOAD VOLTAGE	FULL LOAD CURRENT (I CAS)
T1	T2	V1-V4	CH1	C1	R1			
2200-VOLT POLE TRANSFORMER 2 KVA	UTC 5-71	866-A	20 H. 500 MA. UTC S-37	10 JF. 2500 V.	75 K. 200 W.		1900	500 MA.
3500-0-3500 UTC CG-308	UTC LS-121-Y	872-A	10 H. 500 MA. UTC CG-108	8 JF. 6800 V.	200 K 300 W.		6000	500 MA.

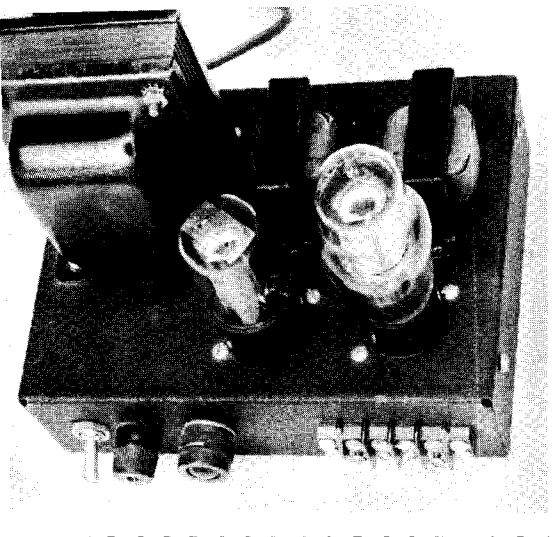

Figure 41
TYPICAL LIGHT DUTY
POWER SUPPLY

This 300 volt, 50 milliamper power supply may be used to run signal generators, frequency meters, small receivers, etc. Switch S₂ (see schematic) is placed on the rear of the chassis near the line cord.

cation in the amateur station for such a supply is for items of test equipment such as the type LM and BC-221 frequency meters, for frequency converters to be used in conjunction with the station receiver, and for auxiliary equipment such as high selectivity i-f strips or variable frequency oscillators. Equipments such as these may be operated from a supply delivering 250 to 300 volts at up to 50 milliamperes of plate current. A filament source of 6.3 or 12 volts may also be required, as will a source of regulated voltage.

The simple power supply illustrated in figures 41 and 42 is capable of meeting these requirements. A two section capacitor input filter system is employed to provide minimum ripple content and a switch (S₂) is provided to insert a VR-150 regulator tube in the circuit to provide 150 volts at approximately 35 milliamperes.

A separate 6.3 volt filament transformer is connected in series with the 6.3 volt winding of power transformer T₁ to provide 12.6 volts at 1.2 amperes for operating "12 volt" tubes or a string of two "6 volt" tubes connected in series. The secondary winding of T₂ must be polarized correctly to provide 12.6 volts across the two windings.

Resistor R₁ must be adjusted to "fire" the voltage regulator tube. It should be adjusted so that approximately 15 milliamperes pass through the tube. For maximum permissible current drain from the high voltage tap of the supply the VR tube should be switched out of the circuit.

32-12 500 Volt, 200 Milliampere Power Supply

The availability of inexpensive "TV-type"

components makes possible the construction of a sturdy 100 watt power supply at a relatively modest price. This power unit is suitable for operating a 50 watt phone/c-w transmitter, a small modulator, or a 100 watt side-band linear amplifier. Maximum intermittent output rating is 500 volts at 200 milliamperes and 6.3 volts at 7 amperes.

The circuit of the supply is shown in figure 44 and is designed around a voltage-doubler type power transformer (Stancor P-8336) having a 117 volt, 280 milliamperere secondary and three 6.3 volt filament windings. The transformer has a 140 watt core and is conservatively rated. In quadrupler service, 100 watts of power may be taken from the high voltage secondary winding provided the filament current drain is held to 40 watts. Under these limitations, the transformer can run for an hour or so before the core becomes warm to the touch.

Four replacement-type selenium rectifiers are used in a simple quadrupler circuit. Although 500 ma. rectifiers are shown, 200 ma. units will work as well. Five ohm surge resistors are employed to limit the starting current of the filter system. Regulation of the

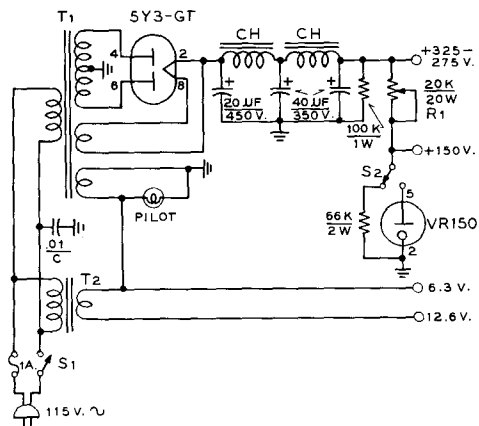

Figure 42
SCHEMATIC, LIGHT DUTY SUPPLY

T₁—350-0-350 volts at 50 milliamperes, 5 volts at 2 amperes, 6.3 volts at 3 amperes, "replacement" transformer.
T₂—6.3 volts at 1.2 amp. Stancor P-6134
CH—4.5 henry at 50 ma. Stancor C-1706

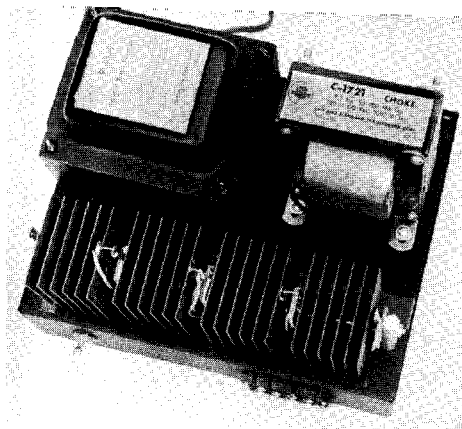

Figure 43
100 WATT "ECONOMY MODEL"
POWER SUPPLY

Employing a TV-type voltage doubler transformer and inexpensive selenium rectifiers, this supply delivers 500 volts at 200 milliamperes with good regulation.

The selenium rectifiers are mounted on a long 6-32 bolt fastened to two upright posts mounted at each front corner of the chassis.

supply is good, the voltage dropping from 600 volts at no load to 500 volts at maximum current drain.

The supply is built upon a steel chassis measuring 9" x 6" x 2". The filter capacitors are mounted in the under-chassis area on phenolic tie-point strips. All transformer leads are left their full length so that the transformer will be in usable shape in the event it is eventually used in a different piece of equipment.

32-13 1500 Volt, 425 Milliampere Power Supply

One of the most popular and also one of the most convenient power ranges for amateur equipment is that which can be supplied from a 1500 volt power unit with a current capability of about 400 ma. The r-f amplifier of an A-M phone transmitter (1500 volts at 250 ma.) capable of 375 watts input and its companion modulator (1500 volts at 20-200 ma.) can both be run from a supply of this rating. The use of this supply for SSB work will permit a p.e.p. of about 600 watts (1500 volts at 400 ma.) with the new low voltage, high current RCA 7094 tetrodes.

This voltage will be found to be very economical when the cost of power supply components is computed. A jump in supply voltage to 2000 will almost double the cost of the various components. Unless full kilowatt operation is intended, 1500 volts is a very convenient and relatively economical compromise voltage.

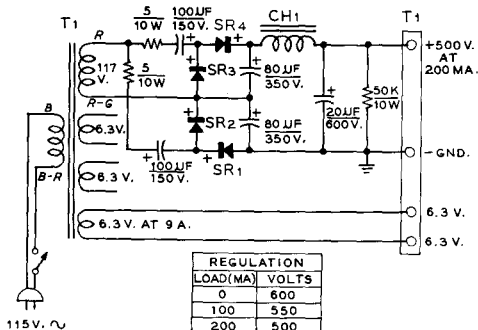

Figure 44

SCHEMATIC, ECONOMY SUPPLY

T_1 —117 volt secondary rated at 280 ma. for doubler service. Three 6.3 volt filament windings. Stancor P-8336.

CH_1 —8.5 henry at 200 ma. Stancor C-1721.

SR_1 —300 ma. selenium rectifier. Sarks-Tarzian or equivalent.

The schematic of a typical supply is shown in figure 46. Primary power source may be either 115 or 230 volts, the latter providing slightly better power supply regulation. The two transformer primaries are connected in series for 230 volt operation, or in parallel for 115 volt operation. In addition the primaries may be connected in series for half-voltage operation on 115 volts as shown. The supply provides 750 volts at 400 ma. under this operating condition.

For optimum dynamic voltage regulation under varying loads such as imposed by side-band or class B modulator equipment the output filter capacitor of the supply should

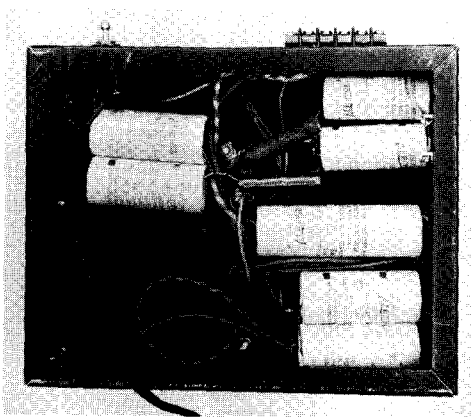

Figure 45
UNDER-CHASSIS VIEW
OF ECONOMY SUPPLY

Two 20 µfd., 450 volt capacitors are connected in parallel for each 80 µfd. unit.

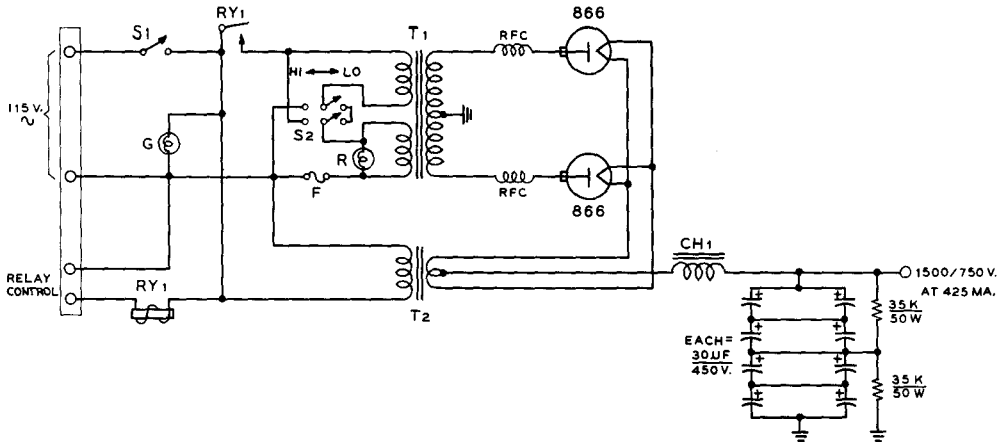

Figure 46
SCHEMATIC, 1500 VOLT, 425 MILLIAMPERE SUPPLY

T₁—1710 - 0 - 1710 volts, 425 ma. 115/230 volt primary. Chicago P-1512
T₂—2.5 volt, 10 ampere, 10 KV insulation. Stancor P-3060
CH₁—6 henry at 300 ma., CCS. Chicago R-63
RFC—"Hash" suppression choke. Millen 77866

be as large as is practical. Occasionally 60 μ fd., 2000 volt capacitors can be picked up on the "surplus" market for a few dollars, although their new price would give most amateurs pause for thought. An inexpensive and reliable substitute may be made up of a group of replacement-type tubular electrolytic capacitors connected in series-parallel as shown in the schematic. Eight 30 μ fd., 450 volt capacitors connected in series parallel will provide an effective value of 15 μ fd., at a working voltage of 1800. This is the minimum value suitable for sideband operation. Sixteen capacitors will provide 30 μ fd., at 1800 volts.

A power supply of this type should be built upon a heavy steel chassis, and all wiring must be done with 10,000 volt TV-type plastic insulated wire. R-F chokes should be placed in the plate leads of the mercury vapor rectifiers as shown, to reduce the tendency these tubes have of breaking into oscillation over a portion of the operating cycle. Oscillation of this type will produce a 120 cycle "buzz" on the sidebands of the signal. The parasitic is eliminated by the use of the chokes.

32-14 A Dual Voltage Transmitter Supply

The majority of high voltage transformers have tapped secondary windings, similar to the transformer shown in the schematic of

figure 47. Separate rectifier and filter systems may be used with the transformer to provide two different output voltages provided the total wattage drain from the supply does not exceed the wattage rating of the transformer. The drain may be divided between the two supply systems in any manner desired. The intermittent rating of *T₂* (figure 47) is 750 watts and the continuous duty rating is 600 watts. Under CCS rating, the supply can provide (for example) 2000 volts at 160 ma. for the operation of an 813 r-f amplifier at 320 watts input, and 1750 volts at 20-150 ma. for the operation of 811-A class B modulators. Under intermittent duty rating, the 813 amplifier can run at 400 watts input (phone) and 500 watts (c-w) without overloading the supply.

A remote switch is used to energize the plate circuit relay of the supply. An auxiliary antenna relay is also operated by the "transmit" switch.

32-15 A Kilowatt Power Supply

Shown in figure 48 is the schematic of a power supply capable of delivering 2500 volts at a continuous current drain of 500 milliamperes, or 700 milliamperes with an intermittent load. The supply is designed to power a kilowatt amplifier operating at 2500 volts and 400 ma., in conjunction with a 500 watt modulator operating at 2500 volts at a vary-

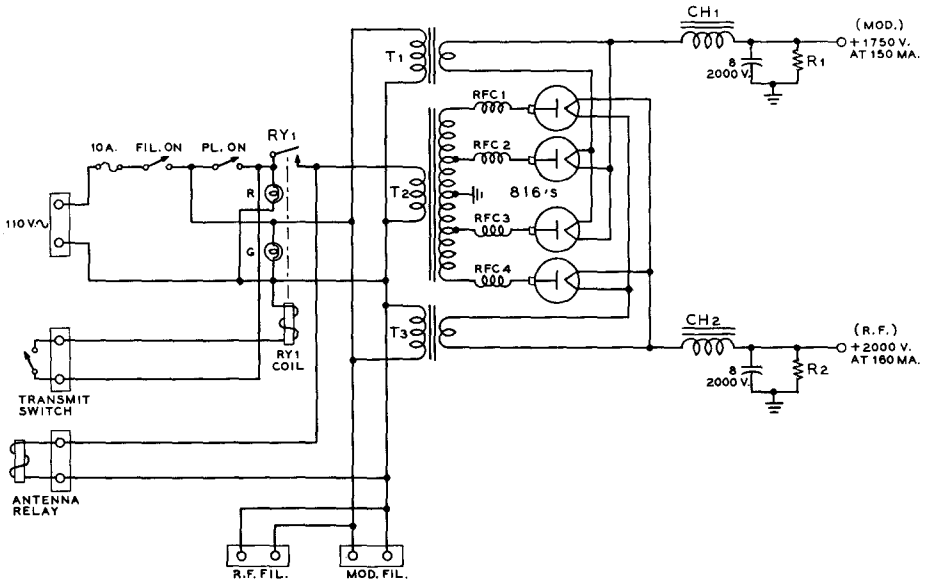

Figure 47

DUAL VOLTAGE POWER SUPPLY

- T₁, T₂—2.5 volts at 5 amperes. Stancor P-6133
- T₃—2400-2100 volts each side center tap at 375 ma. ICAS. Stancor P-8032
- CH₁—3 to 17 henry, 300 ma. Stancor C-1403
- CH₂—8 henry, 300 ma., Stancor C-1413
- R₁, R₂—70K Ω , 100 watt
- RFC₁, RFC₂—“Hash” suppression choke. J. W. Miller 7865 twin chokes (2 req.)
- RY₁—SPST relay, 115 volt coil.

ing current drain of 50-300 ma. Specifically, the supply is employed with a transmitter having a pair of 4-250A tetrode tubes in the class C stage, and a pair of 810 modulator tubes. For sideband work, the supply may be used to power a 1750 watt p.e.p. linear amplifier, such as the 4CX-1000A amplifier shown in an earlier chapter.

Because the total weight of the components is over 150 pounds, the supply should be built directly on the bottom of a relay rack instead of upon a steel chassis.

The r-f hash suppression chokes RFC₁ and RFC₂ are fastened directly to the high voltage terminals of the plate transformer. The two 872-A rectifier tubes are so located that the leads from the r-f chokes to the plate caps are only about three inches long.

A 0.15 μ fd., 5000 volt paper capacitor is used to resonate the filter choke to approximately 120 cycles at a bleeder current of 25 milliamperes. When full load current is drawn, the inductance of the filter choke drops, detuning the parallel resonant circuit. Improved voltage regulation is gained by this action; the no load voltage increases only 200 volts over the full load voltage.

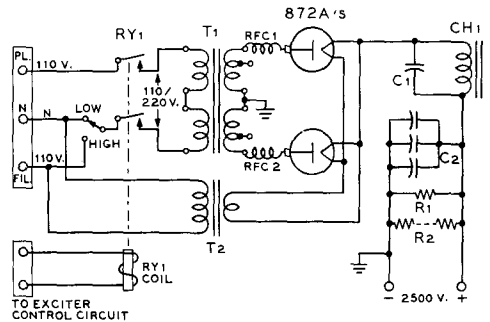

- T₁—2900-0-2900 VOLTS AT 700 MA., ICAS. CHICAGO P-2126
- T₂—5 VOLTS, 10 AMP., CHICAGO F-510H
- CH₁—6 HENRIES, 700 MA. CHICAGO R-67
- C₁—0.15 μ F, 5000-VOLT.
- C₂—THREE 4- μ F 3000-VOLT
- R₁—100,000 OHMS, 200-WATT.
- R₂—ELEVEN 0.5 MEG. 2-WATT RESISTORS IN SERIES
- RY₁—DPST RELAY, 110 V. COIL, 20 A. CONTACTS. POTTER & BRUMFIELD PR7A
- RFC₁, RFC₂—HASH FILTER, J.W. MILLER CO. N^o 7868

Figure 48
HIGH VOLTAGE POWER SUPPLY

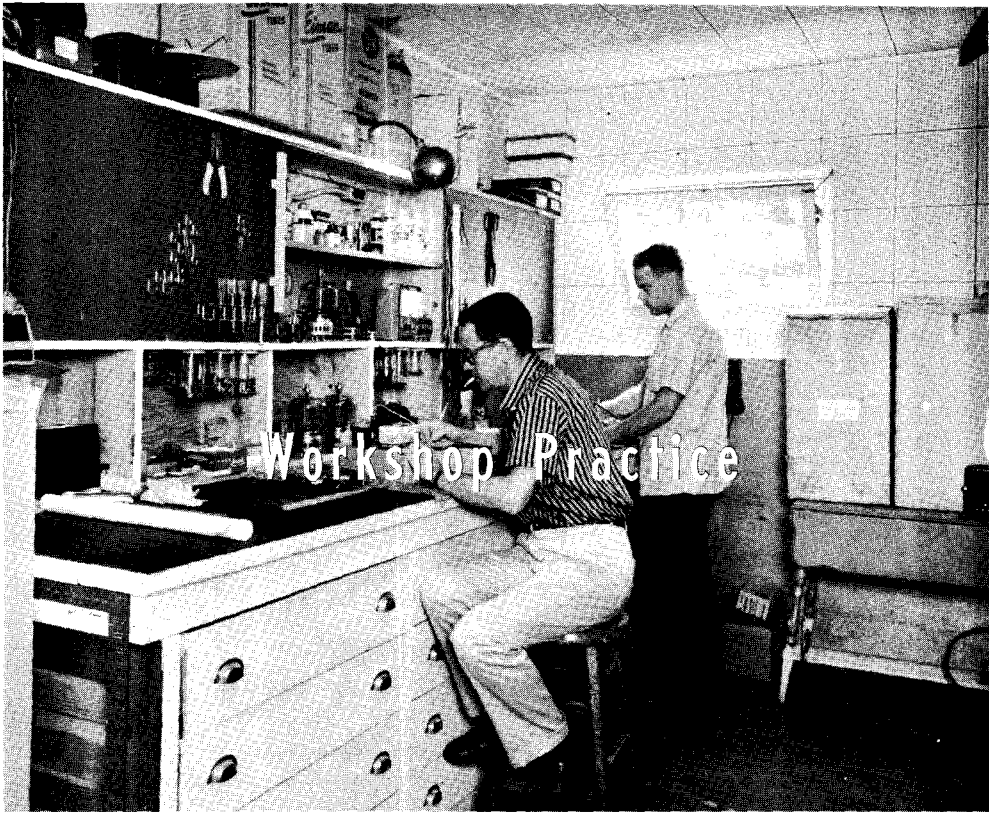

With a few possible exceptions, such as fixed air capacitors, neutralizing capacitors and transmitting coils, it hardly pays one to attempt to build the components required for the construction of an amateur transmitter. This is especially true when the parts are of the type used in construction and replacement work on broadcast receivers, as mass production has made these parts very inexpensive.

Transmitters Those who have and wish to spend the necessary time can effect considerable monetary saving in their transmitters by building them from the component parts. The necessary data is given in the construction chapters of this handbook.

To many builders, the construction is as fascinating as the operation of the finished transmitter; in fact, many amateurs get so much satisfaction out of building a well-performing piece of equipment that they spend more time constructing and rebuilding equipment than they do operating the equipment on the air.

33-1 Tools

Beautiful work can be done with metal chassis and panels with the help of only a few inexpensive tools. The time required for construction, however, will be greatly reduced if a fairly complete assortment of metal-working tools is available. Thus, while an array of tools will speed up the work, excellent results may be accomplished with few tools, if one has the time and patience.

The investment one is justified in making in tools is dependent upon several factors. If you like to tinker, there are many tools useful in radio construction that you would probably buy anyway, or perhaps already have, such as screwdrivers, hammer, saws, square, vise, files, etc. This means that the money taken for tools from your radio budget can be used to buy the more specialized tools, such as socket punches or hole saws, taps and dies, etc.

The amount of construction work one does determines whether buying a large assortment

of tools is an economical move. It also determines if one should buy the less expensive type offered at surprisingly low prices by the familiar mail order houses, "five and ten" stores and chain auto-supply stores, or whether one should spend more money and get first-grade tools. The latter cost considerably more and work but little better when new, but will outlast several sets of the cheaper tools. Therefore they are a wise investment for the experimenter who does lots of construction work (if he can afford the initial cash outlay). The amateur who constructs only an occasional piece of apparatus need not be so concerned with tool life, as even the cheaper grade tools will last him several years, if they are given proper care.

The hand tools and materials in the accompanying lists will be found very useful around the home workshop. Materials not listed but ordinarily used, such as paint, can best be purchased as required for each individual job.

ESSENTIAL HAND TOOLS AND MATERIALS

- 1 *Good* electric soldering iron, about 100 watts,
- 1 Spool rosin-core wire solder
- 1 Each large, medium, small, and midget screwdrivers
- 1 *Good* hand drill (eggbeater type), preferably two-speed
- 1 Pair regular pliers, 6 inch
- 1 Pair long nose pliers, 6 inch
- 1 Pair cutting pliers (diagonals), 5 inch or 6 inch
- 1 1 $\frac{1}{8}$ -inch tube-socket punch
- 1 "Boy Scout" knife
- 1 Combination square and steel rule, 1 foot
- 1 Yardstick or steel pushrule
- 1 Scratch awl or ice pick scribe
- 1 Center punch
- 1 Dozen or more assorted round shank drills (as many as you can afford between no. 50 and $\frac{1}{4}$ or $\frac{3}{8}$ inch, depending upon size of hand drill chuck)
- 1 Combination oil stone
- Light machine oil (in squirt can)
- Friction tape
- 1 Hacksaw and blades
- 1 Medium file and handle
- 1 Cold chisel ($\frac{1}{2}$ inch tip)
- 1 Wrench for socket punch
- 1 Hammer

HIGHLY DESIRABLE HAND TOOLS AND MATERIALS

- 1 Bench vise (jaws at least 3 inch)
- 1 Spool plain wire solder
- 1 Carpenter's brace, ratchet type
- 1 Square-shank countersink bit
- 1 Square-shank taper reamer, small
- 1 Square-shank taper reamer, large (the two reamers should overlap; $\frac{1}{2}$ inch and $\frac{7}{8}$ inch size will usually be suitable)
- 1 $\frac{7}{8}$ inch tube-socket punch (for electrolytic capacitors)
- 1 1-3/16 inch tube-socket punch
- 1 $\frac{5}{8}$ -inch tube-socket punch
- 1 Adjustable circle cutter for holes to 3 inch
- 1 Set small, inexpensive, open-end wrenches
- 1 Pair tin shears, 10 or 12 inch
- 1 Wood chisel ($\frac{1}{2}$ inch tip)
- 1 Pair wing dividers
- 1 Coarse mill file, flat 12 inch
- 1 Coarse bastard file, round, $\frac{1}{2}$ or $\frac{3}{4}$ inch
- 1 Set allen and spline-head wrenches
- 6 or 8 Assorted small files; round, half-round or triangular, flat, square, rat-tail
- 4 Small "C" clamps
- Steel wool, coarse and fine
- Sandpaper and emery cloth, coarse, medium, and fine
- Duco cement
- File brush

USEFUL BUT NOT ESSENTIAL TOOLS AND MATERIALS

- 1 Jig or scroll saw (small) with metal-cutting blades
- 1 Small wood saw (crosscut teeth)
- 1 Each square-shank drills: $\frac{3}{8}$, $\frac{7}{16}$, and $\frac{1}{2}$ inch
- 1 Tap and die outfit for 6-32, 8-32, 10-32 and 10-24 machine screw threads
- 4 Medium size "C" clamps
- Lard oil (in squirt can)
- Kerosene
- Empire cloth
- Clear lacquer ("industrial" grade)
- Lacquer thinner
- Dusting brush
- Paint brushes
- Sheet celluloid, Lucite, or polystyrene
- 1 Carpenter's plane
- 1 Each "Spintite" wrenches, $\frac{1}{4}$, 5/16, 11/32 to fit the standard 6-32 and 8-32 nuts used in radio work
- 1 Screwdriver for recessed head type screws

The foregoing assortment assumes that the constructor does not want to invest in the more expensive power tools, such as drill press,

THE RADIO

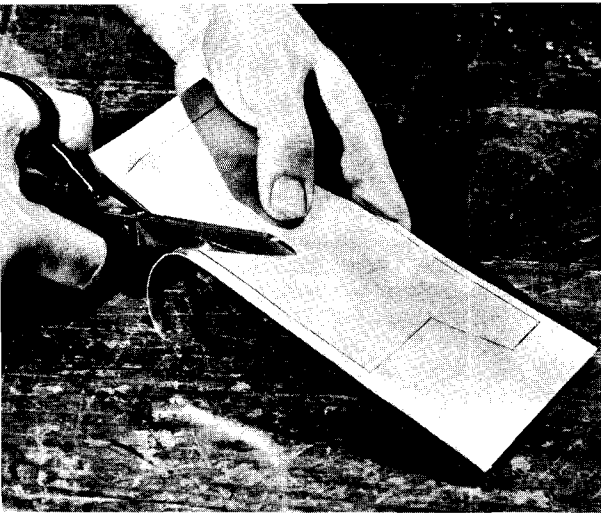

Figure 1
SOFT ALUMINUM
SHEET MAY BE CUT
WITH HEAVY
KITCHEN SHEARS

grinding head, etc. If power equipment is purchased, obviously some of the hand tools and accessories listed will be superfluous. A drill press greatly facilitates construction work, and it is unfortunate that a good one costs as much as a small transmitter.

Not listed in the table are several special-purpose radio tools which are somewhat of a luxury, but are nevertheless quite handy, such as various around-the-corner screwdrivers and wrenches, special soldering iron tips, etc. These can be found in the larger radio parts stores and are usually listed in their mail order catalogs.

If it is contemplated to use the newer and very popular miniature series of tubes (6AK5, 6C4, 6BA6, etc.) in the construction of equipment certain additional tools will be required to mount the smaller components. Miniature

tube sockets mount in a $\frac{5}{8}$ -inch hole, while 9-pin sockets mount in a $\frac{3}{4}$ -inch hole. Greenlee socket punches can be obtained in these sizes, or a smaller hole may be reamed to the proper size. Needless to say, the punch is much the more satisfactory solution. Mounting screws for miniature sockets are usually of the 4-40 size.

Metal Chassis Though quite a few more tools and considerably more time will be required for metal chassis construction, much neater and more satisfactory equipment can be built by mounting the parts on sheet metal chassis instead of breadboards. This type of construction is necessary when shielding of the apparatus is required. A front panel and a back shield minimize the danger of shock and complete the shielding of the enclosure.

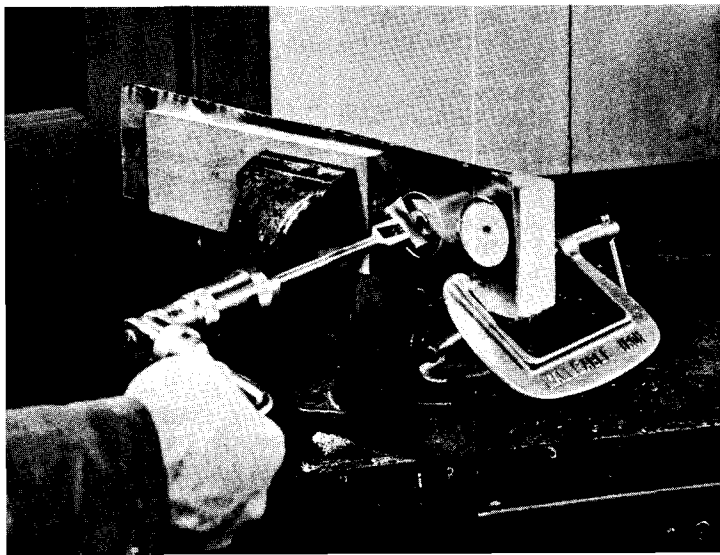
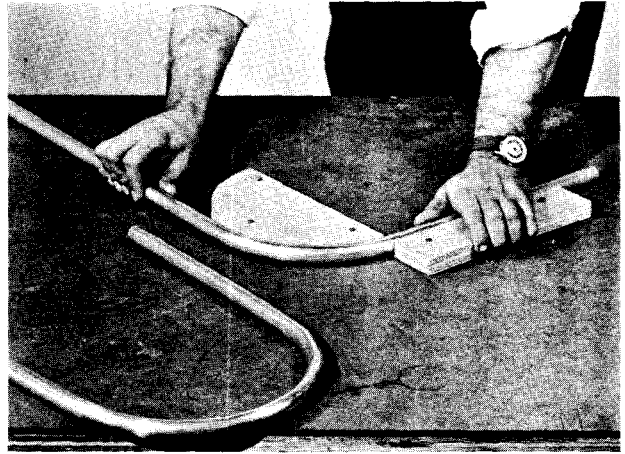

Figure 2
CONVENTIONAL
WOOD EXPANSION
BIT IS EFFECTIVE IN
DRILLING SOCKET
HOLES IN REYNOLDS
DO-IT-YOURSELF
ALUMINUM

Figure 3
SOFT ALUMINUM TUBING MAY BE BENT AROUND WOODEN FORM BLOCKS. TO PREVENT THE TUBE FROM COLLAPSING ON SHARP BENDS, IT IS PACKED WITH WET SAND.



33-2 The Material

Electronic equipment may be built upon foundation of wood, steel or aluminum. The choice of foundation material is governed by the requirements of the electrical circuit, the weight of the components of the assembly, and the financial cost of the project when balanced against the pocketbook contents of the constructor.

Breadboard The simplest method of constructing equipment is to lay it out in *breadboard* fashion, which consists of fastening the various components to a board of suitable size with wood screws or machine bolts, arranging the parts so that important leads will be as short as possible.

Breadboard construction is suitable for testing an experimental layout, or sometimes for assembling an experimental unit of test equipment. But no permanent item of station equipment should be left in the breadboard form. Breadboard construction is dangerous, since components carrying dangerous voltages are left exposed. Also, breadboard construction is never suitable for any r-f portion of a transmitter, since it would be substantially impossible to shield such an item of equipment for the elimination of TVI resulting from harmonic radiation.

Dish type construction is practically the same as metal chassis construction, the main difference lying in the manner in which the chassis is fastened to the panel.

Special Frameworks For high-powered r-f stages, many amateur constructors prefer to discard the more conventional types of construction and employ instead special metal frameworks and brackets which they design specially for the parts which they intend to use. These are usually arranged to give the shortest possible r-f leads and to fasten directly behind a relay rack panel by means of a few bolts, with the control shafts

Figure 4
A WOODWORKING PLANE MAY BE USED TO SMOOTH OR TRIM THE EDGES OF REYNOLDS DO-IT-YOURSELF ALUMINUM STOCK.



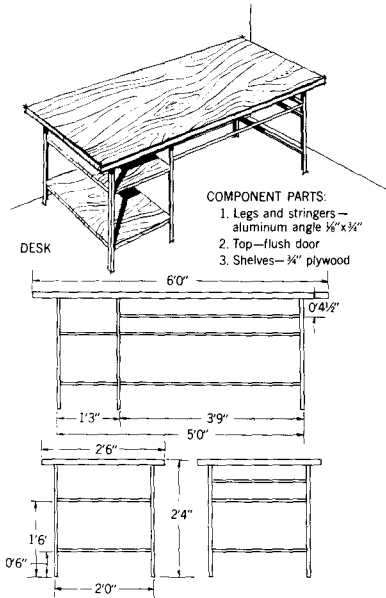

Figure 5

INEXPENSIVE OPERATING DESK MADE FROM ALUMINUM ANGLE STOCK, PLYWOOD AND A FLUSH-TYPE DOOR

projecting through corresponding holes in the panel.

Working with Aluminum The necessity of employing "electrically tight enclosures" for the containment of TVI-producing harmonics has led to the general use of aluminum for chassis, panel, and enclosure construction. If the proper type of aluminum material is used, it may be cut and worked with the usual woodworking tools found in the home shop. Hard, brittle aluminum alloys such as 24ST and 61ST should be avoided, and the softer materials such as 2S or $\frac{1}{2}$ H should be employed.

A new market product is Reynold's *Do-it-yourself* aluminum, which is being distributed on a nationwide basis through hardware stores, lumber yards and building material outlets. This material is an alloy which is temper selected for easy working with ordinary tools. Aluminum sheet, bar and angle stock may be obtained, as well as perforated sheets for ventilated enclosures.

Figures 1 through 4 illustrate how this soft material may be cut and worked with ordinary shop tools, and fig. 5 shows a simple operating desk that may be made from aluminum angle stock, plywood and a flush-type six foot door.

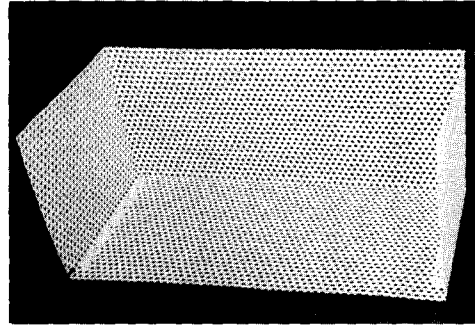

Figure 6

TVI ENCLOSURE MADE FROM SINGLE SHEET OF PERFORATED ALUMINUM

Reynolds Metal Co. "Do-it-yourself" aluminum sheet may be cut and folded to form TVI-proof enclosure. One-half inch lip on edges is bolted to center section with 6-32 machine screws.

33-3 TVI-Proof Enclosures

Armed with a right-angle square, a tin-snips and a straight edge, the home constructor will find the assembly of aluminum enclosures an easy task. This section will show simple construction methods, and short cuts in producing enclosures.

The simplest type of aluminum enclosure is that formed from a single sheet of perforated material as shown in figure 6. The top, sides, and back of the enclosure are of one piece, complete with folds that permit the formed enclosure to be bolted together along the edges. The top area of the enclosure should match the area of the chassis to ensure a close fit. The front edge of the enclosure is attached to aluminum angle strips that are bolted to the front panel of the unit; the sides and back can either be bolted to matching angle strips affixed to the chassis, or may simply be attached to the edge of the chassis with self-tapping sheet metal screws. Enclosures of this type are used on the all-band transmitter described in chapter 31.

A more sophisticated enclosure is shown in figure 7. In this assembly aluminum angle stock is cut to length to form a framework upon which the individual sides, back, and top of the enclosure are bolted. For greatest strength, small aluminum gusset plates should be affixed in each corner of the enclosure. The complete assembly may be held together by no. 6 sheet metal screws.

Regardless of the type of enclosure to be made, care should be taken to ensure that all joints are square. Do not assume that all pre-fabricated chassis and panel are absolutely true and square. Check them before you start to form your shield as any dimensional errors in the foundation will cause endless patching and cutting *after* your enclosure is bolted together. Finally, be sure that paint is removed from the panel and chassis at the point the enclosure attaches to the foundation. A clean, metallic contact along the seam is required for maximum harmonic suppression.

33-4 Enclosure Openings

Openings into shielded enclosures may be made simply by covering them by a piece of shielding held in place by sheet metal screws.

Openings through vertical panels, however, usually require a bit more attention to prevent leakage of harmonic energy through the crack of the door which is supposed to seal the opening. A simple way to provide a panel opening is to employ the *Bud* ventilated door rack panel *model PS-814* or *815*. The grille opening in this panel has holes small enough in area to prevent serious harmonic leakage. The actual door opening, however, does not seal tightly enough to be called TVI-proof. In areas of high TV signal strength where a minimum of operation on 28 Mc. is contemplated, the door is satisfactory as is. To accomplish more complete harmonic suppression, the edges of the opening should be lined with preformed contact finger stock manufactured by *Eitel-McCullough, Inc.*, of San Bruno, Calif. *Eimac* finger stock is an excellent means of providing good contact continuity when using components with adjustable or moving contact surfaces, or in acting as electrical "weatherstrip" around access doors in enclosures. Harmonic leakage through such a sealed opening is reduced to a negligible level. The mating surface to the finger stock should be free of paint, and should provide a good electrical connection to the stock.

A second method of re-establishing electrical continuity across an access port is to employ *Metex* shielding around the mating edges of the opening. *Metex* is a flexible knitted wire mesh which may be obtained in various sizes and shapes. This r-f gasket material is produced by *Metal Textile Corp.*, Roselle, N.J. *Metex* is both flexible and resilient and conforms to irregularities in mating surfaces with a minimum of closing pressure.

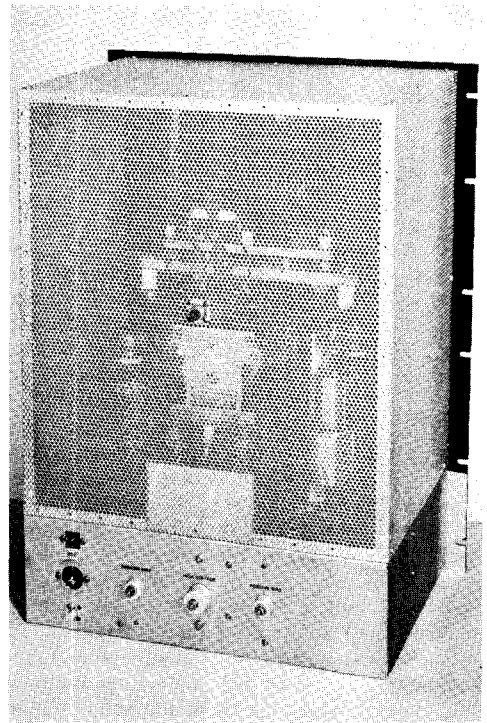

Figure 7
TVI-PROOF ENCLOSURE BUILT OF
PERFORATED ALUMINUM SHEET
AND ANGLE STOCK

33-5 Summation of the Problem

The creation of r-f energy is accompanied by harmonic generation and leakage of fundamental and harmonic energy from the generator source. For practical purposes, radio frequency power may be considered as a form of both electrical and r-f energy. As electrical energy, it will travel along any convenient conductor. As r-f energy, it will radiate directly from the source or from any conductor connected to the source. In view of this "dual personality" of r-f emanations, there is no panacea for all forms of r-f energy leakage. The cure involves both filtering and shielding: one to block the paths of conducted energy, the other to prevent the leakage of radiated energy. The proper combination of filtering and shielding can reduce the radiation of harmonic energy from a signal source some 80 decibels. In most cases, this is sufficient to eliminate interference caused by the generation of undesirable harmonics.

33-6 Construction Practice

Chassis Layout The chassis first should be covered with a layer of wrapping paper, which is drawn tightly down on all sides and fastened with scotch tape. This allows any number of measurement lines and hole centers to be spotted in the correct positions without making any marks on the chassis itself. Place on it the parts to be mounted and play a game of chess with them, trying different arrangements until all the grid and plate leads are made as short as possible, tubes are clear of coil fields, r-f chokes are in safe positions, etc. Remember, especially if you are going to use a panel, that a good mechanical layout often can accompany sound electrical design, but that the electrical design should be given first consideration.

All too often parts are grouped to give a symmetrical panel, irrespective of the arrangement behind. When a satisfactory arrangement has been reached, the mounting holes may be marked. The same procedure now must be followed for the underside, always being careful to see that there are no clashes between the two (that no top mounting screws come down into the middle of a paper capacitor on the underside, that the variable capacitor rotors do not hit anything when turned, etc.).

When all the holes have been spotted, they should be center-punched *through* the paper into the chassis. Don't forget to spot holes for leads which must also come through the chassis.

For transformers which have lugs on the bottoms, the clearance holes may be spotted by pressing the transformer on a piece of paper to obtain impressions, which may then be transferred to the chassis.

Punching In cutting socket holes, one can use either a fly-cutter or socket punches. These punches are easy to operate and only a few precautions are necessary. The guide pin should fit snugly in the guide hole. This increases the accuracy of location of the socket. If this is not of great importance, one may well use a drill of 1/32 inch larger diameter than the guide pin. Some of the punches will operate without guide holes, but the latter always make the punching operations simpler and easier. The only other precaution is to be sure the work is properly lined up before applying the hammer. If this is not done, the punch may slide sideways when you strike and thus not only shear the chassis but also take

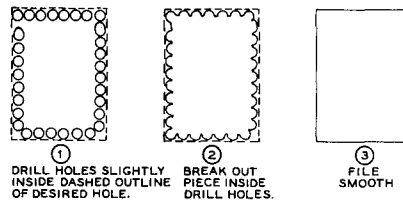

MAKING RECTANGULAR CUTOUT

Figure 8

off part of the die. This is easily avoided by always making sure that the piece is parallel to the faces of the punch, the die, and the base. The latter should be an anvil or other solid base of heavy material.

A punch by *Greenlee* forces socket holes through the chassis by means of a screw turned with a wrench. It is noiseless, and works much more easily and accurately than most others.

The male part of the punch should be placed in the vise, cutting edge up and the female portion forced against the metal with a wrench. These punches can be obtained in sizes to accommodate all tube sockets and even large enough to be used for meter holes. In the octal socket sizes they require the use of a 3/8 inch center hole to accommodate the bolt.

Transformer Cutouts Cutouts for transformers and chokes are not so simply handled.

After marking off the part to be cut, drill about a 1/4-inch hole on each of the inside corners and tangential to the edges. After burring the holes, clamp the piece and a block of cast iron or steel in the vise. Then, take your burring chisel and insert it in one of the corner holes. Cut out the metal by hitting the chisel with a hammer. The blows should be light and numerous. The chisel acts against the block in the same way that the two blades of a pair of scissors work against each other. This same process is repeated for the other sides. A file is used to trim up the completed cutout.

Another method is to drill the four corner holes large enough to take a hack saw blade, then saw instead of chisel. The four holes permit nice looking corners.

Still another method is shown in figure 8. When heavy panel steel is used and a drill press or electric drill is available, this is the most satisfactory method.

Removing Burrs In both drilling and punching, a burr is usually left on the work. There are three simple ways of

removing these. Perhaps the best is to take a chisel (be sure it is one for use on metal) and set it so that its bottom face is parallel to the piece. Then gently tap it with a hammer. This usually will make a clean job with a little practice. If one has access to a counterbore, this will also do a nice job. A countersink will work, although it bevels the edges. A drill of several sizes larger is a much used arrangement. The third method is by filing off the burr, which does a good job but scratches the adjacent metal surfaces badly.

Mounting Components There are two methods in general use for the fastening of transformers, chokes, and similar

pieces of apparatus to chassis or breadboards. The first, using nuts and machine screws, is slow, and the commercial manufacturing practice of using self-tapping screws is gaining favor. For the mounting of small parts such as resistors and capacitors, "tie points" are very useful to gain rigidity. They also contribute materially to the appearance of finished apparatus.

Rubber grommets of the proper size, placed in all chassis holes through which wires are to be passed, will give a neater appearing job and also will reduce the possibility of short circuits.

Soldering Making a strong, low-resistance solder joint does not mean just dropping a blob of solder on the two parts to be joined and then hoping that they'll stick. There are several definite rules that *must* be observed.

All parts to be soldered must be absolutely clean. To clean a wire, lug, or whatever it may be, take your pocket knife and scrape it thoroughly, until fresh metal is laid bare. It is not enough to make a few streaks; scrape until the part to be soldered is bright.

Make a good mechanical joint before applying any solder. Solder is intended primarily to make a good electrical connection; mechanical rigidity should be obtained by bending the wire into a small hook at the end and nipping it firmly around the other part, so that it will hold well even before the solder is applied.

Keep your iron properly tinned. It is impossible to get the work hot enough to take the solder properly if the iron is dirty. To tin your iron, file it, while hot, on one side until a full surface of clean metal is exposed. Immediately apply rosin core solder until a thin layer flows completely over the exposed surface. Repeat for the other faces. Then take a clean rag and wipe off all excess solder and rosin. The iron should also be wiped frequently while the actual construction is going on; it helps prevent pitting the tip.

Apply the solder to the work, not to the iron. The iron should be held against the parts to be joined until they are thoroughly heated. The solder should then be applied against the parts, and the iron should be held in place until the solder flows smoothly and envelopes the work. If it acts like water on a greasy plate, and forms a ball, the work is not sufficiently clean.

The completed joint must be held perfectly still until the solder has had time to solidify. If the work is moved before the solder has be-

NUMBERED DRILL SIZES			
DRILL NUMBER	Diameter (in.)	Clears Screw	Correct for Tapping Steel or Brass†
1	.228		
2	.221	12-24	
3	.213		14-24
4	.209	12-20	
5	.205		
6	.204		
7	.201		
8	.199		
9	.196		
10*	.193	10-32	
11	.191	10-24	
12*	.189		
13	.185		
14	.182		
15	.180		
16	.177		12-24
17	.173		
18*	.169	8-32	
19	.166		12-20
20	.161		
21*	.159		10-32
22	.157		
23	.154		
24	.152		
25*	.149		10-24
26	.147		
27	.144		
28*	.140	6-32	
29*	.136		8-32
30	.128		
31	.120		
32	.116		
33*	.113	4-36 4-40	
34	.111		
35*	.110		6-32
36	.106		
37	.104		
38	.102		
39*	.100	3-48	
40	.098		
41	.096		
42*	.093		4-36 4-40
43	.089	2-56	
44	.086		
45*	.082		3-48

†Use next size larger drill for tapping bakelite and similar composition materials (plastics, etc.).

*Sizes most commonly used in radio construction.

Figure 9

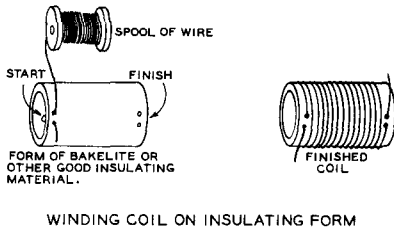
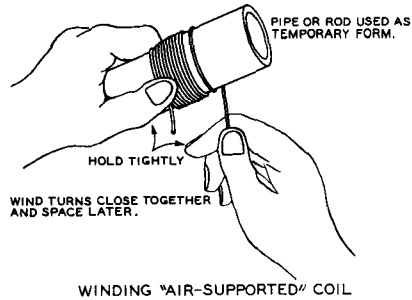

Figure 10



WINDING "AIR-SUPPORTED" COIL

Figure 11

come *completely* solid, a "cold" joint will result. This can be identified immediately, because the solder will have a dull "white" appearance rather than one of shiny "silver." Such joints tend to be of high resistance and will very likely have a bad effect upon a circuit. The cure is simple, merely reheat the joint and do the job correctly.

Wipe away all surplus flux when the joint has cooled if you are using a paste type flux. Be sure it is non-corrosive, and use it with plain (not rosin core) solder.

Finishes If the apparatus is constructed on a painted chassis (commonly available in black wrinkle and gray wrinkle), there is no need for application of a protective coating when the equipment is finished, assuming that you are careful not to scratch or mar the finish while drilling holes and mounting parts. However, many amateurs prefer to use unpainted (zinc or cadmium plated) chassis, because it is much simpler to make a chassis ground connection with this type of chassis. A thin coat of clear "linoleum" lacquer may be applied to the whole chassis after the wiring is completed to retard rusting. In localities near the sea coast it is a good idea to lacquer the various chassis cutouts even on a painted chassis, as rust will get a good start at these points unless the metal is protected where the drill or saw has exposed it. If too thick a coat is applied, the lacquer will tend to peel. It may be thinned with lacquer thinner to permit application of a light coat. A thin coat will adhere to any *clean* metal surface that is not too shiny.

An attractive dull gloss finish, almost velvety can be put on aluminum by sand-blasting it with a very weak blast and fine particles and then lacquering it. Soaking the aluminum in a solution of lye produces somewhat the same effect as a fine grain sand blast.

There are also several brands of dull gloss black enamels on the market which adhere well to metals and make a nice appearance. Airdrying wrinkle finishes are sometimes successful, but a bake job is usually far better. Wrinkle finishes, properly applied, are very durable and are pleasing to the eye. If you live in a large community, there is probably an enameling concern which can wrinkle your work for you at a reasonable cost. A very attractive finish, for panels especially, is to spray a wrinkle finish with aluminum paint. In any painting operation (or plating, either, for that matter), the work should be very thoroughly cleaned of all greases and oils.

To protect brass from tarnish, thoroughly cleanse and remove the last trace of grease by the use of potash and water. The brass must be carefully rinsed with water and dried; but in doing it, care must be taken not to handle any portion with the bare hands or anything else that is greasy. Then lacquer.

Winding Coils Coils are of two general types, those using a form and "air-wound" types. Neither type offers any particular constructional difficulties. Figure 10 illustrates the procedure used in form winding a coil. If the winding is to be spaced, the spacing can be done either by eye or a string or another piece of wire may be wound simultaneously with the coil wire and removed after the winding is in place. The usual procedure is to clamp one end of the wire in a vise, attaching the other end to the coil form and with the coil form in hand, walk slowly towards the vise winding the wire but at the same time keeping a strong tension on the wire as the form is rotated. After the coil is wound, if there is any possibility of the turns slipping, the completed coil is either entirely coated with a coil or Duco cement or cemented in those spots where slippage might occur.

**Figure 12
GOOD SHOP
LAYOUT AIDS
CAREFUL
WORKMANSHIP**

Built in a corner of a garage, this shop has all features necessary for electronic work. Test instruments are arranged on shelves above bench. Numerous outlets reduce "haywire" produced by tangled line cords. Not shown in picture are drill press and sander at end of left bench

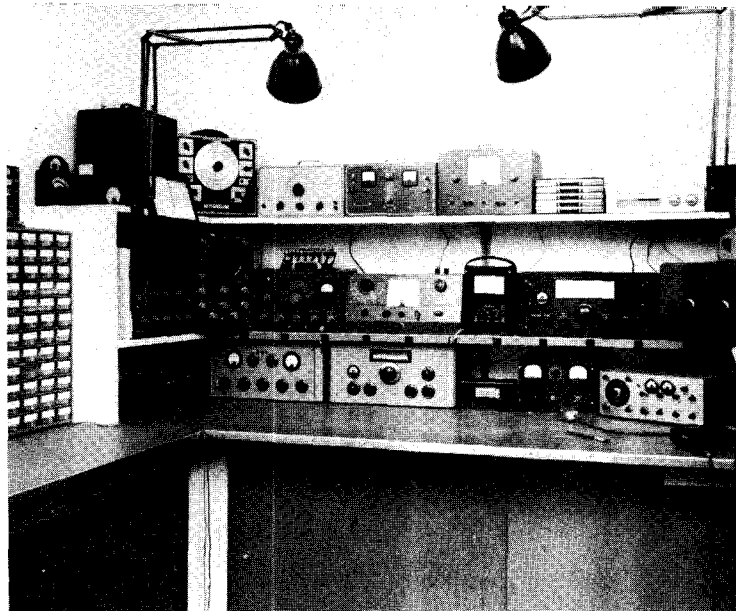

V-h-f and u-h-f coils are commonly wound of heavy enameled wire on a form and then removed from the form as in figure 11. If the coil is long or has a tendency to buckle, strips of polystyrene or a similar material may be cemented longitudinally inside the coil. Due allowance must be made for the coil springing out when removed from the form, when selecting the diameter of the form.

On air wound coils of this type, spacing between turns is accomplished after removal from the form, by running a pencil, the shank of a screwdriver or other round object spirally between the turns from one end of the coil to the other, again making due allowance for spring.

Air-wound coils, approaching the appearance of commercially manufactured ones, can be constructed by using a round wooden form which has been sawed diagonally from end to end. Strips of insulating material are temporarily attached to this mandrel, the wire then being wound over these strips with the desired separation between turns and cemented to the strips. When dry, the split mandrel may be removed by unwedging it.

33-7 Shop Layout

The *size* of your workshop is relatively unimportant since the shop *layout* will determine its efficiency and the ease with which you may complete your work.

Shown in figure 12 is a workshop built into a 10'x10' area in the corner of a garage. The workbench is 32" wide, made up of four strips of 2"x8" lumber supported on a solid

framework made of 2"x4" lumber. The top of the workbench is covered with hard-surface *Masonite*. The edge of the surface is protected with aluminum "counter edging" strip, obtainable at large hardware stores. Two wooden shelves 12" wide are placed above the bench to hold the various items of test equipment. The shelves are bolted to the wall studs with large angle brackets and have wooden end pieces. Along the edge of the lower shelf a metal "outlet strip" is placed that has an 115-volt outlet every six inches along its length. A similar strip is run along the *back* of the lower shelf. The front strip is used for equipment that is being bench-tested, and the rear strip powers the various items of test equipment placed on the shelves.

At the left of the bench is a storage bin for small components. A file cabinet can be seen at the right of the photograph. This necessary item holds schematics, transformer data sheets, and other papers that normally are lost in the usual clutter and confusion.

The area below the workbench has two storage shelves which are concealed by sliding doors made of 1/4-inch *Masonite*. Heavier tools, and large components are stored in this area. On the floor and not shown in the photograph is a very necessary item of shop equipment: a large trash receptacle.

A compact and efficient shop built in one-half of a wardrobe closet is shown in figure 13. The workbench length is four feet. The top is made of 4"x6" lumber sheathed with hard surface *Masonite* and trimmed with "counter edging" strip. The supporting struc-

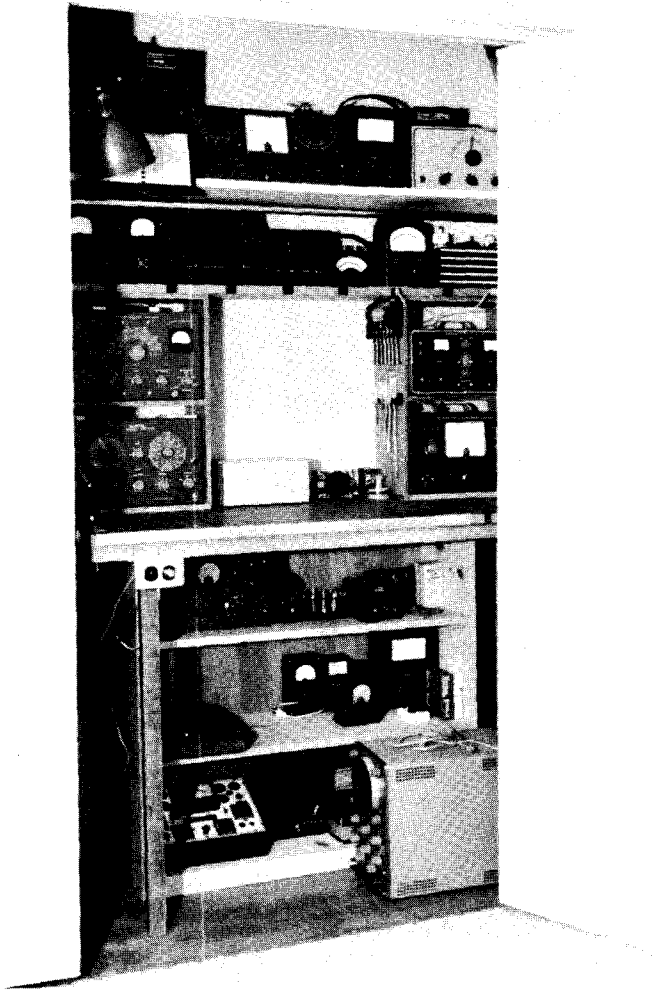

Figure 13
COMPLETE WORKSHOP IN A CLOSET!
Careful layout permits complete electronic workshop to be placed in one-half of a wardrobe closet. Work bench is built atop an unpainted three-shelf bookcase.

ture is made from an unpainted three-shelf bookcase. A 2"x2" leg is placed under the front corners of the bench to provide maximum stability.

Atop the bench, a small wooden framework supports needed items of test equipment and

a single shelf contains a 115-volt "outlet strip." The instruments at the top of the photo are placed on the wardrobe shelf.

When not in use, the doors of the wardrobe are closed, concealing the workshop completely from view.

Electronic Test Equipment

All amateur stations are required by law to have certain items of test equipment available within the station. A c-w station is required to have a frequency meter or other means in addition to the transmitter frequency control for insuring that the transmitted signal is on a frequency within one of the frequency bands assigned for such use. A radiophone station is required in addition to have a means of determining that the transmitter is not being modulated in excess of its modulation capability, and in any event not more than 100 per cent. Further, any station operating with a power input greater than 900 watts is required to have a means of determining the exact input to the final stage of the transmitter, so as to insure that the power input to the plate circuit of the output stage does not exceed 1000 watts.

The additional test and measurement equipment required by a station will be determined by the type of operation contemplated. It is desirable that all stations have an accurately calibrated volt-ohmmeter for routine transmitter and receiver checking and as an assistance in getting new pieces of equipment into operation. An oscilloscope and an audio oscillator make a very desirable adjunct to a phone station using AM or FM transmission, and are a necessity if single-sideband operation is contemplated. A calibrated signal generator is almost a necessity if much receiver work is contemplated, although a frequency meter of LM or BC-221 type, particularly if it includes internal modulation, will serve in place of the signal generator. Extensive antenna work in-

variably requires the use of some type of field-strength meter, and a standing-wave meter of some type is very helpful. Lastly, if much v-h-f work is to be done, a simple grid-dip meter will be found to be one of the most used items of test equipment in the station.

34-1 Voltage, Current and Power

The measurement of voltage and current in radio circuits is very important in proper maintenance of equipment. Vacuum tubes of the types used in communications work must be operated within rather narrow limits in regard to filament or heater voltage, and they must be operated within certain maximum limits in regard to the voltage and current on other electrodes.

Both direct current and voltage are most commonly measured with the aid of an instrument consisting of a coil that is free to rotate in a constant magnetic field (*d'Arsonval* type instrument). If the instrument is to be used for the measurement of current it is called an *ammeter* or *milliammeter*. The current flowing through the circuit is caused to flow through the moving coil of this type of instrument. If the current to be measured is greater than 10 milliamperes or so it is the usual practice to cause the majority of the current to flow through a by-pass resistor called a shunt, only a specified portion of the current flowing through the moving coil of the instrument. The calculation of shunts for extending the range of d-c milliammeters and ammeters is discussed in Chapter Two.

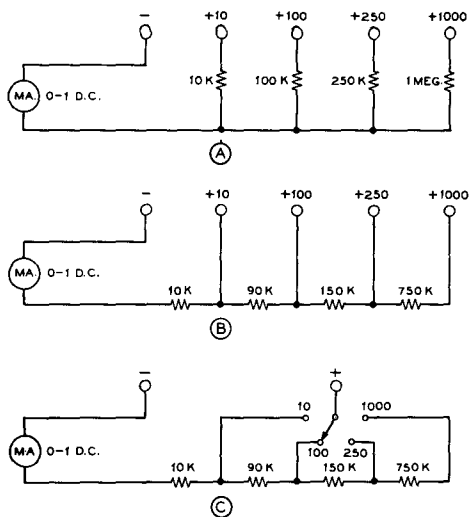

Figure 1

MULTI-VOLTMETER CIRCUITS

(A) shows a circuit whereby individual multiplier resistors are used for each range. (B) is the more economical "series multiplier" circuit. The same number of resistors is required, but those for the higher ranges have less resistance, and hence are less expensive when precision wirewound resistors are to be used. (C) shows a circuit essentially the same as at (A), except that a range switch is used. With a 0-500 d-c microammeter substituted for the 0-1 milliammeter shown above, all resistor values would be multiplied by two and the voltmeter would have a "2000-ohm-per-volt" sensitivity. Similarly, if a 0-50 d-c microammeter were to be used, all resistance values would be multiplied by twenty, and the voltmeter would have a sensitivity of 20,000 ohms per volt.

A direct current *voltmeter* is merely a d-c milliammeter with a *multiplier* resistor in series with it. If it is desired to use a low-range milliammeter as a voltmeter the value of the multiplier resistor for any voltage range may be determined from the following formula:

$$R = \frac{1000 E}{I}$$

where: R = multiplier resistor in ohms
E = desired full scale voltage
I = full scale current of meter in ma.

The sensitivity of a voltmeter is commonly expressed in *ohms per volt*. The higher the ohms per volt of a voltmeter the greater its sensitivity. When the full-scale current drain of a voltmeter is known, its sensitivity rating in ohms per volt may be determined by:

$$\text{Ohms per volt} = \frac{1000}{I}$$

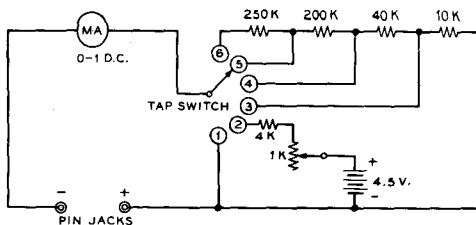
Figure 2
VOLT-OHMMETER CIRCUIT

With the switch in position 1, the 0-1 milliammeter would be connected directly to the terminals. In position 2 the meter would read from 0-100,000 ohms, approximately, with a resistance value of 4500 ohms at half scale. (Note: The half-scale resistance value of an ohmmeter using this circuit is equal to the resistance in series with the battery inside the instrument.) The other four taps are voltage ranges with 10, 50, 250, and 500 volts full scale.

Where I is the full-scale current drain of the indicating instrument in milliamperes.

Multi-Range Meters It is common practice to connect a group of multiplier resistors

in the circuit with a single indicating instrument to obtain a *multi-range voltmeter*. There are several ways of wiring such a meter, the most common ones of which are indicated in figure 1. With all these methods of connection, the sensitivity of the meter in ohms per volt is the same on all scales. With a 0-1 milliammeter as shown the sensitivity is 1000 ohms per volt.

Volt-Ohmmeters An extremely useful piece of test equipment which should be found in every laboratory or radio station is the *volt-ohmmeter*. It consists of a multi-range voltmeter with an additional fixed resistor, a variable resistor, and a battery. A typical example of such an instrument is diagrammed in figure 2. Tap 1 is used to permit use of the instrument as an 0-1 d-c milliammeter. Tap 2 permits accurate reading of resistors up to 100,000 ohms; taps 3, 4, 5, and 6 are for making voltage measurements, the full scale voltages being 10, 50, 250, and 500 volts respectively.

The 1000-ohm potentiometer is used to bring the needle to zero ohms when the terminals are shorted; this adjustment should always be made before a resistance measurement is taken. Higher voltages than 500 can be read if a higher value of multiplier resistor is added to an additional tap on the switch. The proper value for a given full scale reading can be determined from Ohm's law.

Resistances higher than 100,000 ohms can-

not be measured accurately with the circuit constants shown; however, by increasing the ohmmeter battery to 45 volts and multiplying the 4000-ohm resistor and 1000-ohm potentiometer by 10, the ohms scale also will be multiplied by 10. This would permit accurate measurements up to 1 megohm.

0-1 d-c milliammeters are available with special volt-ohmmeter scales which make individual calibration unnecessary. Or, special scales can be purchased separately and substituted for the original scale on the milliammeter.

Obviously, the accuracy of the instrument either as a voltmeter or as an ammeter can be no better than the accuracy of the milliammeter and the resistors.

Because volt-ohmmeters are so widely used and because the circuit is standardized to a considerable extent, it is possible to purchase a factory-built volt-ohmmeter for no more than the component parts would cost if purchased individually. For this reason no construction details are given. However, anyone already possessing a suitable milliammeter and desirous of incorporating it in a simple volt-ohmmeter should be able to build one from the schematic diagram and design data given here. Special, precision (accurately calibrated) multiplier resistors are available if a high degree of accuracy is desired. Alternatively, good quality carbon resistors whose actual resistance has been checked may be used as multipliers where less accuracy is required.

Medium- and Low-Range Ohmmeter Most ohmmeters, including the one just described, are not adapted for accurate measurement of low-resistances—in the neighborhood of 100 ohms, for instance.

The ohmmeter diagrammed in figure 3 was especially designed for the reasonably accurate reading of resistances down to 1 ohm. Two scales are provided, one going in one direction and the other scale going in the other direction because of the different manner in which the milliammeter is used in each case. The low scale covers from 1 to 100 ohms and the high scale from 100 to 10,000 ohms. The high scale is in reality a medium-range scale. For accurate reading of resistances over 10,000 ohms, an ohmmeter of the type previously described should be used.

The 1-100 ohm scale is useful for checking transformers, chokes, r-f coils, etc., which often have a resistance of only a few ohms.

The calibration scale will depend upon the internal resistance of the particular make of

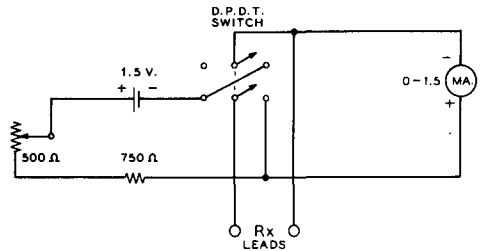

Figure 3
SCHEMATIC OF A LOW-RANGE OHMMETER

A description of the operation of this circuit is given in the text. With the switch in the left position the half-scale reading of the meter will occur with an external resistance of 1000 ohms. With the switch in the right position, half-scale deflection will be obtained with an external resistance equal to the d-c resistance of the milliammeter (20 to 50 ohms depending upon the make of instrument).

1.5-ma. meter used. The instrument can be calibrated by means of a Wheatstone bridge or a few resistors of known accuracy. The latter can be series-connected and parallel-connected to give sufficient calibration points. A hand-drawn hand-calibrated scale can be cemented over the regular meter scale to give a direct reading in ohms.

Before calibrating the instrument or using it, the test prods should always be touched together and the zero adjuster set accurately.

Measurement of Alternating Current and Voltage The measurement of alternating current and voltage is complicated

by two factors; first, the frequency range covered in ordinary communication channels is so great that calibration of an instrument becomes extremely difficult; second, there is no single type of instrument which is suitable for all a-c measurements—as the d'Arsonval type of movement is suitable for d-c. The d'Arsonval movement will not operate on a-c since it indicates the average value of current flow, and the average value of an a-c wave is zero.

As a result of the inability of the reliable d'Arsonval type of movement to record an alternating current, either this current must be rectified and then fed to the movement, or a special type of movement which will operate from the *effective* value of the current can be used.

For the usual measurements of power frequency a.c. (25-60 cycles) the *iron-vane* instrument is commonly used. For audio frequency a.c. (50-20,000 cycles) a d'Arsonval

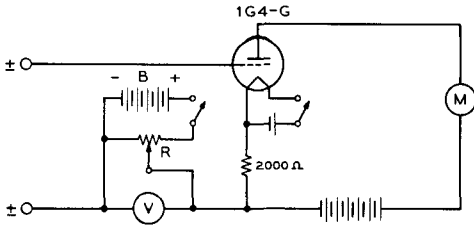

Figure 4
SLIDE-BACK V-T VOLTMETER

By connecting a variable source of voltage in series with the input to a conventional v-t voltmeter, or in series with the simple triode voltmeter shown above, a slide-back a-c voltmeter for peak voltage measurement can be constructed. Resistor R should be about 1000 ohms per volt used at battery B. This type of v-t voltmeter has the advantage that it can give a reading of the actual peak voltage of the wave being measured, without any current drain from the source of voltage.

instrument having an integral copper oxide or selenium rectifier is usually used. Radio frequency voltage measurements are usually made with some type of vacuum-tube voltmeter, while r-f current measurements are almost invariably made with an instrument containing a thermo-couple to convert the r.f. into d.c. for the movement.

Since an alternating current wave can have an almost infinite variety of shapes, it can easily be seen that the ratios between the three fundamental quantities of the wave (peak, r.m.s. effective, and average after rectification) can also vary widely. So it becomes necessary to know beforehand just which quality of the wave under measurement our instrument is going to indicate. For the purpose of simplicity we can list the usual types of a-c meters in a table along with the characteristic of an a-c wave which they will indicate:

Iron-vane, thermocouple—r.m.s.

Rectifier type (copper oxide or selenium)
—average after rectification.

V.t.v.m.—r.m.s., average or peak, depending upon design and calibration.

Vacuum-Tube Voltmeters A vacuum-tube voltmeter is essentially a detector in which a change in the signal placed upon the input will produce a change in the indicating instrument (usually a d'Arsonval meter) placed in the output circuit. A vacuum-tube voltmeter may use a diode, a triode, or a multi-element tube, and it may be used either for the measurement of a.c. or d.c.

When a v.t.v.m. is used in d-c measurement it is used for this purpose primarily because of the very great input resistance of the device.

This means that a v.t.v.m. may be used for the measurement of a-v-c, a-f-c, and discriminator output voltages where no loading of the circuit can be tolerated.

A-C V-T Voltmeters There are many different types of a-c vacuum-tube voltmeters, all of which operate as some type of rectifier to give an indication on a d-c instrument. There are two general types: those which give an indication of the r-m-s value of the wave (or approximately this value of a complex wave), and those which give an indication of the peak or crest value of the wave.

Since the setting up and calibration of a wide-range vacuum-tube voltmeter is rather tedious, in most cases it will be best to purchase a commercially manufactured unit. Several excellent commercial units are on the market at the present time; also kits for home construction of a quite satisfactory v.t.v.m. are available from several manufacturers. These feature a wide range of a-c and d-c voltage scales at high sensitivity, and in addition several feature a built-in vacuum-tube ohmmeter which will give indications up to 500 or 1000 megohms.

Peak A-C V-T Voltmeters There are two common types of peak-indicating vacuum-tube voltmeters. The first is the so-called *slide-back* type in which a simple v.t.v.m. is used along with a conventional d-c voltmeter and a source of bucking bias in series with the input. With this type of arrangement (figure 4) leads are connected to the voltage to be measured and the slider resistor R across the bucking voltage is backed down until an indication on the meter (called a false zero) equal to that value given with the prods shorted and the bucking voltage reduced to zero, is obtained. Then the value of the bucking voltage (read on V) is equal to the peak value of the voltage under measurement. The slide-back voltmeter has the disadvantage that it is not instantaneous in its indication—adjustments must be made for every voltage measurement. For this reason the slide-back v.t.v.m. is not commonly used, being supplanted by the diode-rectifier type of peak v.t.v.m. for most applications.

High-Voltage Diode Peak Voltmeter A diode vacuum-tube voltmeter suitable for the measurement of high values of a-c voltage is diagrammed in figure 5. With the constants shown, the voltmeter has two

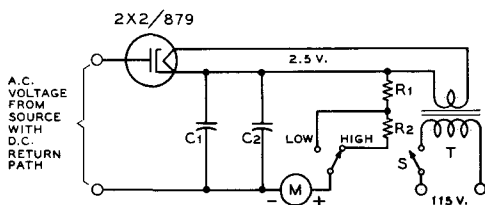

Figure 5
SCHEMATIC OF A HIGH-VOLTAGE PEAK VOLTMETER

A peak voltmeter such as diagrammed above is convenient for the measurement of peak voltages at fairly high power levels from a source of moderately low impedance.

- C₁—0.01- μ fd. high-voltage mica
- C₂—1.0- μ fd. high-voltage paper
- R₁—500,000 ohms (two 0.25-megohm 1/2-watt in series)
- R₂—1.0 megohm (four 0.25-megohm 1/2-watt in series)
- T—2.5 v., 1.75 a. filament transformer
- M—0-1 d-c milliammeter
- S_{H1-1.0}—S-p-d-t toggle switch
- S—S-p-s-t toggle switch

(Note: C₁ is a by-pass around C₂, the inductive reactance of which may be appreciable at high frequencies.)

ranges: 500 and 1500 volts *peak* full scale.

Capacitors C₁ and C₂ should be able to withstand a voltage in excess of the highest peak voltage to be measured. Likewise, R₁ and R₂ should be able to withstand the same amount of voltage. The easiest and least expensive way of obtaining such resistors is to use several low-voltage resistors in series, as shown in figure 5. Other voltage ranges can be obtained by changing the value of these resistors, but for voltages less than several hundred volts a more linear calibration can be obtained by using a receiving-type diode. A calibration curve should be run to eliminate the appreciable error due to the high internal resistance of the diode, preventing the capacitor from charging to the full peak value of the voltage being measured.

A direct reading diode peak voltmeter of the type shown in figure 5 will load the source of voltage by approximately *one-half* the value of the load resistance in the circuit (R₁, or R₁ plus R₂, in this case). Also, the peak voltage reading on the meter will be slightly less than the actual peak voltage being measured. The amount of lowering of the reading is determined by the ratio of the reactance of the storage capacitance to the load resistance. If a cathode-ray oscilloscope is placed across the terminals of the v.t.v.m. when a voltage is being measured, the actual amount of the lowering in voltage may be determined by inspection

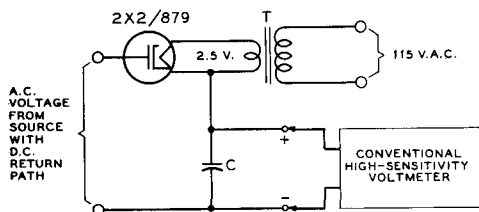

Figure 6
PEAK-VOLTAGE MEASUREMENT CIRCUIT

Through use of the arrangement shown above it is possible to make accurate measurements of peak a-c voltages, such as across the secondary of a modulation transformer, with a conventional d-c multi-voltmeter. Capacitor C and transformer T should, of course, be insulated for the highest peak voltage likely to be encountered. A capacitance of 0.25- μ fd. at C has been found to be adequate. The higher the sensitivity of the indicating d-c voltmeter, the smaller will be the error between the indication on the meter and the actual peak voltage being measured.

of the trace on the c-r tube screen. The peak positive excursion of the wave will be slightly flattened by the action of the v.t.v.m. Usually this flattening will be so small as to be negligible.

An alternative arrangement, shown in figure 6, is quite convenient for the measurement of high a-c voltages such as are encountered in the adjustment and testing of high-power audio amplifiers and modulators. The arrangement consists simply of a 2X2 rectifier tube and a filter capacitor of perhaps 0.25- μ fd. capacitance, but with a voltage rating high enough that it is not likely to be punctured as a result of any tests made. Cathode-ray oscilloscope capacitors, and those for electrostatic-deflection TV tubes often have ratings as high as 0.25 μ fd. at 7500 to 10,000 volts. The indicating instrument is a conventional multi-scale d-c voltmeter of the high-sensitivity type, preferably with a sensitivity of 20,000 or 50,000 ohms per volt. The higher the sensitivity of the d-c voltmeter used with the rectifier, the smaller will be the amount of flattening of the a-c wave as a result of the rectifier action.

Measurement of Power Audio frequency or radio frequency power in a resistive circuit is most commonly and most easily determined by the indirect method, i.e., through the use of one of the following formulas:

$$P = EI \quad P = E^2/R \quad P = I^2R$$

These three formulas mean that if any two of the three factors determining power are known

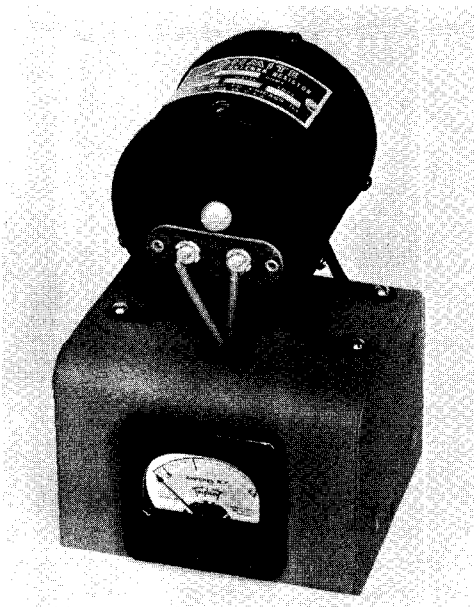

Figure 7

100-WATT DUMMY LOAD SUITABLE FOR RANGER, OR SIMILAR TYPE TRANSMITTER

(resistance, current, voltage) the power being dissipated may be determined. In an ordinary 120-volt a-c line circuit the above formulas are not strictly true since the power factor of the load must be multiplied into the result—or a direct method of determining power such as a wattmeter may be used. But in a resistive a-f circuit and in a resonant r-f circuit the power factor of the load is taken as being unity.

For accurate measurement of a-f and r-f power, a *thermogalvanometer* or *thermocouple* ammeter in series with a non-inductive resistor of known resistance can be used. The meter should have good accuracy, and the exact value of resistance should be known with accuracy. Suitable dummy load resistors are available in various resistances in both 100 and 250-watt ratings. These are virtually non-inductive, and may be considered as a pure resistance up to 30 Mc. The resistance of these units is substantially constant for all values of current up to the maximum dissipation rating, but where extreme accuracy is required, a correction chart of the dissipation coefficient of resistance (supplied by the manufacturer) may be employed. This chart shows

the exact resistance for different values of current through the resistor.

Sine-wave power measurements (r-f or single-frequency audio) may also be made through the use of a v.t.v.m. and a resistor of known value. In fact a v.t.v.m. of the type shown in figure 6 is particularly suited to this work. The formula, $P = E^2/R$ is used in this case. However, it must be remembered that a v.t.v.m. of the type shown in figure 6 indicates the *peak* value of the a-c wave. This reading must be converted to the r-m-s or *heating* value of the wave by multiplying it by 0.707 before substituting the voltage value in the formula. The same result can be obtained by using the formula $P = E^2/2R$.

Thus all three methods of determining power, ammeter-resistor, voltmeter-resistor, and voltmeter-ammeter, give an excellent cross-check upon the accuracy of the determination and upon the accuracy of the *standards*.

Power may also be measured through the use of a *calorimeter*, by actually measuring the amount of heat being dissipated. Through the use of a water-cooled dummy load resistor this method of power output determination is being used by some of the most modern broadcast stations. But the method is too cumbersome for ordinary power determinations.

Power may also be determined *photometrically* through the use of a voltmeter, ammeter, incandescent lamp used as a load resistor, and a photographic exposure meter. With this method the exposure meter is used to determine the relative visual output of the lamp running as a dummy load resistor and of the lamp running from the 120-volt a-c line. A rheostat in series with the lead from the a-c line to the lamp is used to vary its light intensity to the same value (as indicated by the exposure meter) as it was putting out as a dummy load. The a-c voltmeter in parallel with the lamp and ammeter in series with it is then used to determine lamp power input by: $P = EI$. This method of power determination is satisfactory for audio and low frequency r.f. but is not satisfactory for v-h-f work because of variations in lamp efficiency due to uneven heating of the filament.

Dummy Loads Lamp bulbs make poor dummy loads for r-f work, in general, as they have considerable reactance above 2 Mc., and the resistance of the lamp varies with the amount of current passing through it.

A suitable r-f load for powers up to a few watts may be made by paralleling 2-watt composition resistors of suitable value to make

a 50-ohm resistor of 5 or 10 watts dissipation. The resistors should be mounted in a compact bundle, with short interconnecting leads.

For powers of 100 and 250 watts, the *Ohmite* models *D-101* and *D-251* low inductance resistors may be used as dummy antennas. A *D-101* resistor mounted on a small metal chassis with a r-f ammeter and coaxial plug is shown in figure 7. The *Ohmite D-250* resistor may be employed in such a configuration for higher power.

A dummy load capable of taking the output of a plate-modulated 1-kilowatt transmitter is shown in figure 8. The load is made up of ten 160-watt, 500-ohm *Ohmite type 2409* non-inductive resistors. These resistors are mounted between two aluminum end plates measuring 4 inches in diameter. The assembly is then end mounted by means of 1" ceramic insulators to an aluminum chassis containing the r-f ammeter and an SO-239 coaxial receptacle.

This dummy load presents a good approximation of a 50-ohm, 1600-watt resistor up to approximately 8 Mc. Above this frequency, it becomes increasingly reactive. It may be used up to 30 Mc., if it is remembered that the reading of the r-f ammeter no longer is an absolute indication of the resistive power dissipation of the load. For use on the 20, 15 and 10 meter bands, it is recommended that the coaxial line coupling the dummy load to the transmitter either be restricted to a length of two feet or less, or else be made an electrical half-wavelength long. This will insure that a minimum of reactance will be coupled back into the transmitter.

34-2 Measurement of Circuit Constants

The measurement of the resistance, capacitance, inductance, and Q (figure of merit) of the components used in communications work can be divided into three general methods: the impedance method, the substitution or resonance method, and the bridge method.

The Impedance Method The *impedance method* of measuring inductance and capacitance can be likened to the ohmmeter method for measuring resistance. An a-c voltmeter, or milliammeter in series with a resistor, is connected in series with the inductance or capacitance to be measured and the a-c line. The reading of the meter will be inversely proportional to the impedance of the component being measured. After the meter has been calibrated it will be possible to

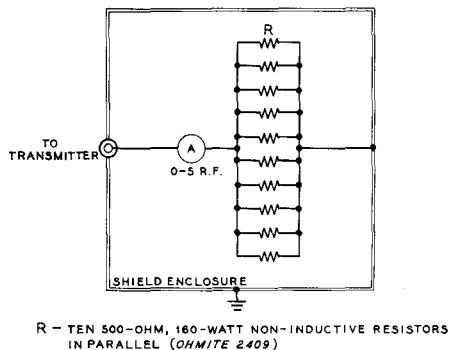

Figure 8
1.6-KILOWATT DUMMY LOAD SCHEMATIC

obtain the approximate value of the impedance directly from the scale of the meter. If the component is a capacitor, the value of impedance may be taken as its reactance at the measurement frequency and the capacitance determined accordingly. But the d-c resistance of an inductor must also be taken into consideration in determining its inductance. After the d-c resistance and the impedance have been determined, the reactance may be determined from the formula: $X_L = \sqrt{Z^2 - R^2}$. Then the inductance may be determined from: $L = X_L / 2\pi f$.

The Substitution Method The *substitution method* is a satisfactory system for obtaining the inductance or capacitance of high-frequency components. A large variable capacitor with a good dial having an accurate calibration curve is a necessity for making determinations by this method. If an unknown inductor is to be measured, it is connected in parallel with the standard capacitor and the combination tuned accurately to some known frequency. This tuning may be accomplished either by using the tuned circuit as a wavemeter and coupling it to the tuned circuit of a reference oscillator, or by using the tuned circuit in the controlling position of a two terminal oscillator such as a dynatron or transitron. The capacitance required to tune this first frequency is then noted as C_1 . The circuit or the oscillator is then tuned to the *second harmonic* of this first frequency and the amount of capacitance again noted, this time as C_2 . Then the distributed capacitance across the coil (including all stray capacitances) is equal to: $C_0 = (C_1 - 4C_2) / 3$.

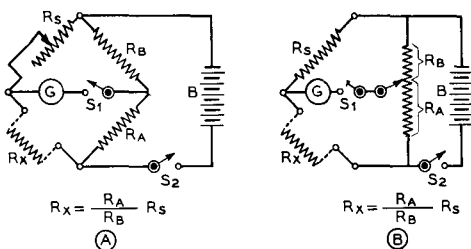

Figure 9

TWO WHEATSTONE BRIDGE CIRCUITS

These circuits are used for the measurement of d-c resistance. In (A) the "ratio arms" R_B and R_A are fixed and balancing of the bridge is accomplished by variation of the standard R_S . The standard in this case usually consists of a decade box giving resistance in 1-ohm steps from 0 to 1110 or to 11,110 ohms. In (B) a fixed standard is used for each range and the ratio arm is varied to obtain balance. A calibrated slide-wire or potentiometer calibrated by resistance in terms of degrees is usually employed as R_A and R_B . It will be noticed that the formula for determining the unknown resistance from the known is the same in either case.

This value of distributed capacitance is then substituted in the following formula along with the value of the standard capacitance for either of the two frequencies of measurement:

$$L = \frac{1}{4\pi^2 f^2 (C_1 + C_0)}$$

The determination of an unknown capacitance is somewhat less complicated than the above. A tuned circuit including a coil, the unknown capacitor and the standard capacitor, all in parallel, is resonated to some convenient frequency. The capacitance of the standard capacitor is noted. Then the unknown capacitor is removed and the circuit re-resonated by means of the standard capacitor. The difference between the two readings of the standard capacitor is then equal to the capacitance of the unknown capacitor.

34-3 Measurements with a Bridge

Experience has shown that one of the most satisfactory methods for measuring circuit constants (resistance, capacitance, and inductance) at audio frequencies is by means of the a-c bridge. The *Wheatstone (d-c) bridge* is also one of the most accurate methods for the measurement of d-c resistance. With a simple bridge of the type shown at figure 9A it is entirely practical to obtain d-c resistance de-

terminations accurate to four significant figures. With an a-c bridge operating within its normal rating as to frequency and range of measurement it is possible to obtain results accurate to three significant figures.

Both the a-c and the d-c bridges consist of a source of energy, a standard or reference of measurement, a means of balancing this standard against the unknown, and a means of indicating when this balance has been reached. The source of energy in the d-c bridge is a battery; the indicator is a sensitive galvanometer. In the a-c bridge the source of energy is an audio oscillator (usually in the vicinity of 1000 cycles), and the indicator is usually a pair of headphones. The standard for the d-c bridge is a resistance, usually in the form of a decade box. Standards for the a-c bridge can be resistance, capacitance, and inductance in varying forms.

Figure 9 shows two general types of the Wheatstone or d-c bridge. In (A) the so-called "ratio arms" R_A and R_B are fixed (usually in a ratio of 1-to-1, 1-to-10, 1-to-100, or 1-to-1,000) and the standard resistor R_S is varied until the bridge is in balance. In commercially manufactured bridges there are usually two or more buttons on the galvanometer for progressively increasing its sensitivity as balance is approached. Figure 9B is the *slide wire* type of bridge in which fixed standards are used and the ratio arm is continuously variable. The slide wire may actually consist of a moving contact along a length of wire of uniform cross section in which case the ratio of R_A to R_B may be read off directly in centimeters or inches, or in degrees of rotation if the slide wire is bent around a circular former. Alternatively, the slide wire may consist of linear-wound potentiometer with its dial calibrated in degrees or in resistance from each end.

Figure 10A shows a simple type of a-c bridge for the measurement of capacitance and inductance. It can also, if desired, be used for the measurement of resistance. The four arms of the bridge may be made up in a variety of ways. As before, R_B and R_A make up the ratio arms of the device and may be either of the slide wire type, as indicated, or they may be fixed and a variable standard used to obtain balance. In any case it is always necessary with this type of bridge to use a standard which presents the same type of impedance as the unknown being measured: resistance standard for a resistance measurement, capacitance standard for capacitance, and inductance stand-

ard for inductance determination. Also, it is a great help in obtaining an accurate balance of the bridge if a standard of approximately the same value as the assumed value of the unknown is employed. Also, the standard should be of the same general type and should have approximately the same power factor as the unknown impedance. If all these precautions are observed, little trouble will be experienced in the measurement of resistance and in the measurement of impedances of the values usually used in audio and low radio frequency work.

However, the bridge shown at 10A will not be satisfactory for the measurement of capacitances smaller than about 1000 μmfd . For the measurement of capacitances from a few micro-microfarads to about 0.001 μfd , a Wagner grounded substitution capacitance bridge of the type shown in figure 10B will be found satisfactory. The ratio arms R_A and R_B should be of the same value within 1 per cent; any value between 2500 and 10,000 ohms for both will be satisfactory. The two resistors R_C and R_D should be 1000-ohm wire-wound potentiometers. C_S should be a straight-line capacitance capacitor with an accurate vernier dial; 500 to 1000 μmfd . will be satisfactory. C_0 can be a two or three gang broadcast capacitor from 700 to 1000 μmfd . maximum capacitance.

The procedure for making a measurement is as follows: The unknown capacitor C_X is placed in parallel with the standard capacitor C_S . The *Wagner ground* R_D is varied back and forth a small amount from the center of its range until no signal is heard in the phones with the switch S in the center position. Then the switch S is placed in either of the two outside positions, C_0 is adjusted to a capacitance somewhat greater than the assumed value of the unknown C_X , and the bridge is brought into balance by variation of the standard capacitor C_S . It may be necessary to cut some resistance in at R_C and to switch to the other outside position of S before an exact balance can be obtained. The setting of C_S is then noted, C_X is removed from the circuit (but the leads which went to it are not changed in any way which would alter their mutual capacitance), and C_S is readjusted until balance is again obtained. The difference in the two settings of C_S is equal to the capacitance of the unknown capacitor C_X .

There are many other types of a-c bridge circuits in common use for measuring inductance with a capacitance standard, frequency

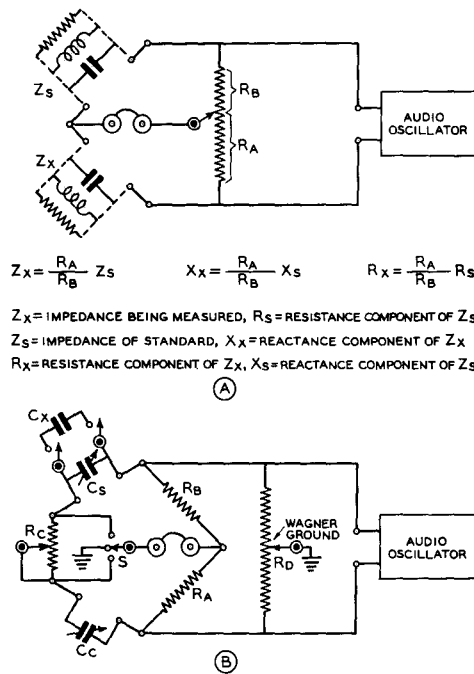

$$Z_x = \frac{R_A}{R_B} Z_s \quad X_x = \frac{R_A}{R_B} X_s \quad R_x = \frac{R_A}{R_B} R_s$$

Z_x = IMPEDANCE BEING MEASURED, R_s = RESISTANCE COMPONENT OF Z_s
 Z_s = IMPEDANCE OF STANDARD, X_x = REACTANCE COMPONENT OF Z_x
 R_x = RESISTANCE COMPONENT OF Z_x , X_s = REACTANCE COMPONENT OF Z_s

Figure 10
TWO A-C BRIDGE CIRCUITS

The operation of these bridges is essentially the same as those of figure 9 except that a.c. is fed into the bridge instead of d.c. and a pair of phones is used as the indicator instead of the galvanometer. The bridge shown at (A) can be used for the measurement of resistance, but it is usually used for the measurement of the impedance and reactance of coils and capacitors at frequencies from 200 to 1000 cycles. The bridge shown at (B) is used for the measurement of small values of capacitance by the substitution method. Full description of the operation of both bridges is given in the accompanying text.

in terms of resistance and capacitance, and so forth. Terman's *Radio Engineers' Handbook* gives an excellent discussion of common types of a-c bridge circuits.

34-4 Frequency Measurements

All frequency measurement within the United States is based on the transmissions of Station WWV of the *National Bureau of Standards*. This station operates continuously on frequencies of 2.5, 5, 10, 15, 20, 25, 30, and 35 Mc. The carriers of those frequencies below 30 Mc. are modulated alternately by a 440-cycle tone or a 600-cycle tone for periods of four minutes each. This tone is interrupted at the beginning of the 59th minute

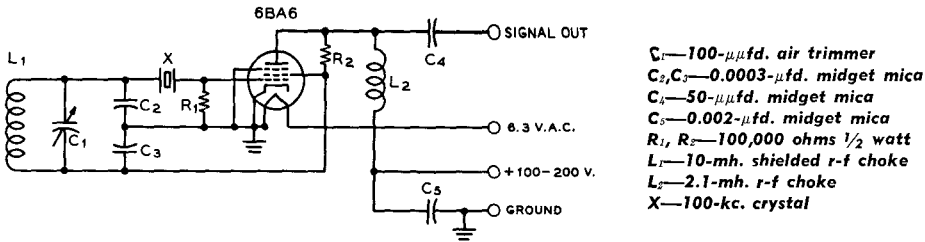

Figure 11
SCHEMATIC OF A 100-KC. FREQUENCY SPOTTER

of each hour and each five minutes thereafter for a period of precisely one minute. *Greenwich Civil Time* is given in code during these one-minute intervals, followed by a voice announcement giving Eastern Standard Time. The accuracy of all radio and audio frequencies is better than one part in 50,000,000. A 5000 microsecond pulse (5 cycles of a 1000-cycle wave) may be heard as a tick for every second except the 59th second of each minute.

These standard-frequency transmissions of station WWV may be used for accurately determining the limits of the various amateur bands with the aid of the station communications receiver and a 50-kc., 100-kc., or 200-kc. band-edge spotter. The low frequency oscillator may be self-excited if desired, but low frequency standard crystals have become so relatively inexpensive that a reference crystal may be purchased for very little more than the cost of the components for a self-excited oscillator. The crystal has the additional advantage that it may be once set so that its harmonics are at zero beat with WWV and then left with only an occasional check to see that the frequency has not drifted more than a few cycles. The self-excited oscillator, on the other hand, must be monitored very frequently to insure that it is on frequency.

Using a Frequency Spotter To use a *frequency spotter* it is only necessary to couple the output of the oscillator unit to the antenna terminal of the receiver through a very small capacitance such as might be made by twisting two pieces of insulated hookup wire together. Station WWV is then tuned in on one of its harmonics, 15 Mc. will usually be best in the daytime and 5 or 10 Mc. at night, and the trimmer adjustment on the oscillator is varied until zero beat is obtained between the harmonic of the oscillator and WWV. With a crystal reference oscillator no difficulty will be had with using

the wrong harmonic of the oscillator to obtain the beat, but with a self-excited oscillator it will be wise to insure that the reference oscillator is operating exactly on 50, 100, or 200 kc. (whichever frequency has been chosen) by making sure that zero beat is obtained simultaneously on all the frequencies of WWV that can be heard, and by noting whether or not the harmonics of the oscillator in the amateur bands fall on the approximate calibration marks of the receiver.

A simple frequency spotter is diagrammed in figure 11.

34-5 Antenna and Transmission Line Measurements

The degree of adjustment of any amateur antenna can be judged by the study of the standing-wave ratio on the transmission line feeding the antenna. Various types of instruments have been designed to measure the s.r.w. present on the transmission line, or to measure the actual radiation resistance of the antenna in question. The most important of these instruments are the *slotted line*, the *bridge-type s-w-r meter*, and the *antennascope*.

The Slotted Line It is obviously impractical to measure the voltage-standing-wave ratio in a length of coaxial line since the voltages and currents inside the line are completely shielded by the outer conductor of the cable. Hence it is necessary to insert some type of instrument into a section of the line in order to be able to ascertain the conditions which are taking place inside the shielded line. Where measurements of a high degree of accuracy are required, the *slotted line* is the instrument most frequently used. Such an instrument, diagrammed in figure 12, is an item of test equipment which could be constructed in a home workshop which included a lathe and other metal working tools.

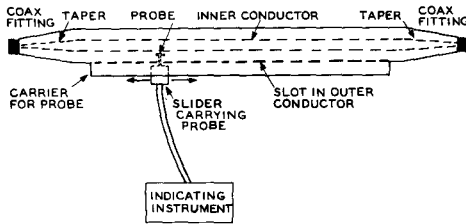

Figure 12
DIAGRAMMATIC REPRESENTATION
OF A SLOTTED LINE

The conductor ratios in the slotted line, including the tapered end sections should be such that the characteristic impedance of the equipment is the same as that of the transmission line with which the equipment is to be used. The indicating instrument may be operated by the d-c output of the rectifier coupled to the probe, or it may be operated by the a-c components of the rectified signal if the signal generator or transmitter is amplitude modulated by a constant percentage.

Commercially built slotted lines are very expensive since they are constructed with a high degree of accuracy for precise laboratory work. The slotted line consists essentially of a section of air-dielectric line having the same characteristic impedance as the transmission line into which it is inserted. Tapered fittings for the transmission line connectors at each end of the slotted line usually are required due to differences in the diameters of the slotted line and the line into which it is inserted. A narrow slot from 1/8-inch to 1/4-inch in width is cut into the outer conductor of the line. A probe then is inserted into the slot so that it is coupled to the field inside the line. Some sort of accurately machined track or lead screw must be provided to insure that the probe maintains a constant spacing from the inner conductor as it is moved from one end of the slotted line to the other. The probe usually includes some type of rectifying element whose output is fed to an indicating instrument alongside the slotted line.

The unfortunate part of the slotted-line system of measurement is that the line must be somewhat over one-half wavelength long at the test frequency, and for best results should be a full wavelength long. This requirement is easily met at frequencies of 420 Mc. and above where a full wavelength is 28 inches or less. But for the lower frequencies such an instrument is mechanically impracticable.

Bridge-Type Standing-Wave Indicators

The bridge type of standing-wave indicator is used generally for making measurements on commercial co-

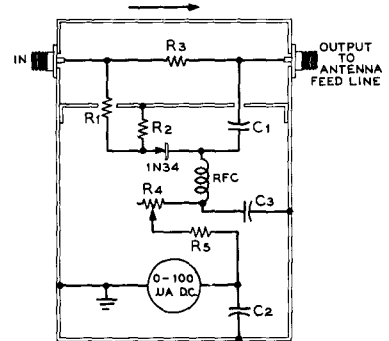

Figure 13
RESISTOR-BRIDGE
STANDING-WAVE INDICATOR

This type of test equipment is suitable for use with coaxial feed lines.

- C₁—0.001- μ fd. midget ceramic capacitor
- C₂, C₃—.001 disc ceramic
- R₁, R₂—22-ohm 2-watt carbon resistors
- R₃—Resistor equal in resistance to the characteristic impedance of the coaxial transmission line to be used (1 watt)
- R₄—5000-ohm wire-wound potentiometer
- R₅—10,000-ohm 1-watt resistor
- RFC—R-f choke suitable for operation at the measurement frequency

axial transmission lines. A simplified version is available from M. C. Jones Electronics Co., Bristol, Conn. ("Micro-Match").

One type of bridge standing-wave indicator is diagrammed in figure 13. This type of instrument compares the electrical impedance of the transmission line with that of the resistor R₃ which is included within the unit. Experience with such units has shown that the resistor R₃ should be a good grade of non-inductive carbon type. The *Ohmite* "Little Devil" type resistor in the 2-watt rating has given good performance. The resistance at R₃ should be equal to the characteristic impedance of the antenna transmission line. In other words, this resistor should have a value of 52 ohms for lines having this characteristic impedance such as RG-8/U and RG-58/U. For use with lines having a nominal characteristic impedance of 70 ohms, a selected "68 ohm" resistor having an actual resistance of 70 ohms may be used.

Balance within the equipment is checked by mounting a resistor, equal in value to the nominal characteristic impedance of the line to be used, on a coaxial plug of the type used on the end of the antenna feed line. Then this plug is inserted into the *input* receptacle of the instrument and a power of 2 to 4 watts applied to the *output* receptacle on the desired frequency of operation. Note that the signal is passed through the bridge in the direction

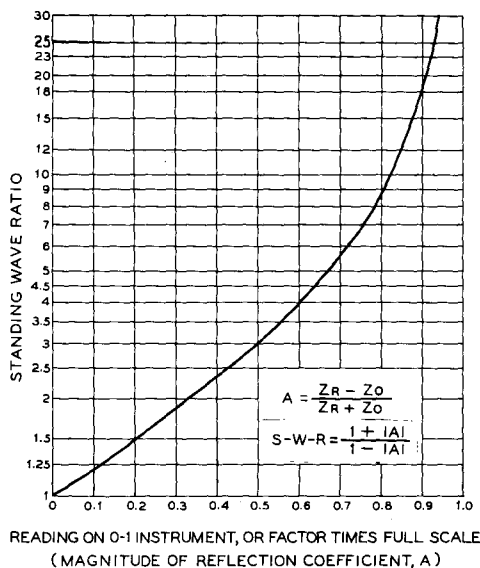
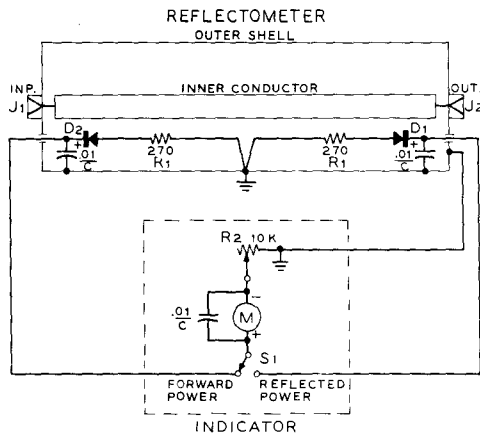

Figure 14

RELATION BETWEEN STANDING-WAVE RATIO AND REFLECTION COEFFICIENT

This chart may be used to convert reflection-coefficient indications such as are obtained with a bridge-type standing-wave indicator or an indicating twin lamp into values of standing-wave ratio.



COMPONENT PARTS

- END DISC = 2 3/8" DIAMETER X 1/4" (2 REQ.)
- OUTER SHELL = 2 3/8" I.D. X 6" (1 REQ.)
- ALIGNMENT ROD = 1/4" DIAMETER X 5 1/2" (2 REQ.)
- INNER CONDUCTOR = 1/2" DIAMETER X 5 1/8", TAPER ENDS TO SOLDER TO RECEPTACLES (2 REQ.)
- RECEPTACLES = 50-239 (2 REQ.) (J1, J2)
- BINDING POSTS = (3 REQ.)

Figure 15
SCHEMATIC, REFLECTOMETER

- D₁, D₂—Crystal diode, 1N34A or 1N82
- R₁—270 ohm, 1 watt composition resistor.
- IRC type BTA, matched pair.
- M—0-1 d.c. milliammeter
- J₁, J₂—Coaxial receptacle, 50-239.

opposite to normal for this test. The resistor R_4 is adjusted for full-scale deflection on the 0-100 microammeter. Then the plugs are reversed so that the test signal passes through the instrument in the direction indicated by the arrow on figure 13, and the power level is maintained the same as before. If the test resistor is matched to R_3 , and stray capacitances have been held to low values, the indication on the milliammeter will be very small. The test plug with its resistor is removed and the plug for the antenna transmission line is inserted. The meter indication now will read the reflection coefficient which exists on the antenna transmission line at the point where the indicator has been inserted. From this reading of reflection coefficient the actual standing-wave ratio on the transmission line may be determined by reference to the chart of figure 14.

Measurements of this type are quite helpful in determining whether or not the antenna is presenting a good impedance match to the transmission line being used to feed it. However, a test instrument of the type shown in

figure 13 must be inserted into the line for a measurement, and then removed from the line when the equipment is to be operated. Also, the power input to the line feeding the input terminal of the standing-wave indicator must not exceed 4 watts. The power level which the unit can accept is determined by the dissipation limitation of resistors R_1 plus R_2 .

It is also important, for satisfactory operation of the test unit, that resistors R_1 and R_2 be exactly equal in value. The actual resistance of these two is not critically important, and deviations up to 10 per cent from the value given in figure 13 will be satisfactory. But the two resistors must have the same value, whether they are both 21 ohms or 24 ohms, or some value in between.

34-6 A Simple Coaxial Reflectometer

The reflectometer is a short section of coaxial transmission line containing two r-f voltmeters. One voltmeter reads the *incident component of voltage* in the line, and the other

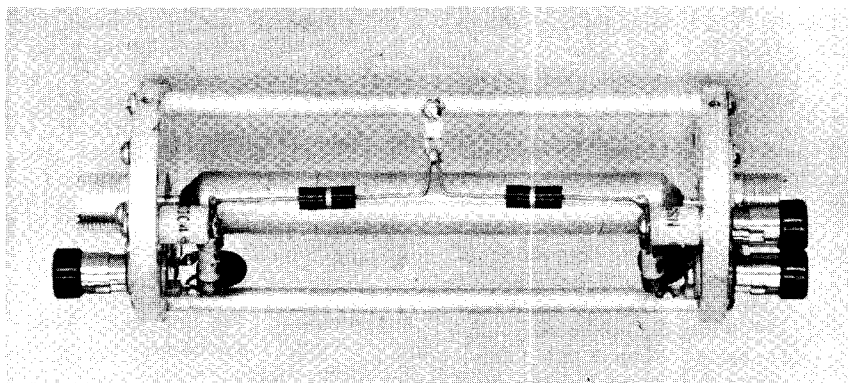

Figure 16

INTERIOR VIEW OF COAXIAL REFLECTOMETER

The Reflectometer is a short section of transmission line containing two r-f voltmeters. Center conductor of line is a section of brass rod soldered to center pins of input and output receptacles. At either end of unit are the crystal diodes, bypass capacitors and terminals. Diode load resistors are at center of instrument, grounded to brass alignment rod.

reads the *reflected component*. The magnitude of standing wave ratio on the transmission line is the ratio of the incident component to the reflected component, as shown in figure 14. In actual use, calibration of the reflectometer is not required since the relative reading of reflected power indicates the degree of match or mis-match and all antenna and transmission line adjustments should be conducted so as to make this reading as low as possible, regardless of its absolute value.

The actual meter readings obtained from the device are a function of the operating frequency, the sensitivity of the instrument being a function of transmitter power, increasing rapidly as the frequency of operation is increased. However, the reflectometer is invaluable in that it may be left permanently in the transmission line, regardless of the power output level of the transmitter. It will indicate the degree of reflected power in the antenna system, and at the same time provide a visual indication of the power output of the transmitter.

Reflectometer Circuit The circuit and assembly information for the reflectometer are given in figure 15. Two diode voltmeters are coupled back-to-back to a short length of transmission line. The combined inductive and capacitive pickup between each voltmeter and the line is such that the incident component of the line voltage is balanced out in one case and the inductive component is balanced out in the other case. Each voltmeter, therefore, reads only one wave-com-

ponent. Careful attention to physical symmetry of the assembly insures accurate and complete separation of the voltage components by the two voltmeters. The outputs of the two voltmeters may be selected and read on an external meter connected to the terminal posts of the reflectometer.

Each r-f voltmeter is composed of a load resistor and a pickup loop. The pickup loop is positioned parallel to a section of transmission line permitting both inductive and capacitive coupling to exist between the center conductor of the line and the loop. The dimensions of the center conductor and the outer shield of the reflectometer are chosen so that the instrument impedance closely matches that of the transmission line.

Reflectometer Construction A view of the interior of the reflectometer is shown in figure 16. The coaxial input and output connectors of the instrument are mounted on machined brass discs that are held in place by brass alignment rods, tapped at each end. The center conductor is machined from a short section of brass rod, tapered and drilled at each end to fit over the center pin of each coaxial receptacle. The end discs, the rods, and the center conductor should be silver plated before assembly. When the center conductor is placed in position, it is soldered at each end to the center pin of the coaxial receptacles.

One of the alignment rods is drilled and tapped for a 6-32 bolt at the mid-point, and the end discs are drilled to hold 1/2-inch

ceramic insulators and binding posts, as shown in the photograph. The load resistors, crystal diodes, and bypass capacitors are finally mounted in the assembly as the last step.

The two load resistors should be measured on an ohmmeter to ensure that the resistance values are equal. The exact value of resistance is unimportant as long as the two resistors are equal. The diodes should also be checked on an ohmmeter to make sure that the front resistances and back resistances are balanced between the units. Care should be taken during soldering to ensure the diodes and resistors are not overheated. Observe that the resistor leads are of equal length and that each half of the assembly is a mirror-image of the other half. The body of the resistor is spaced about $\frac{1}{8}$ -inch away from the center conductor.

Testing the Reflectometer The instrument can be adjusted on the 28 Mc. band.

An r-f source of a few watts and nonreactive load are required. The construction of the reflectometer is such that it will work well with either 52- or 72-ohm coaxial transmission lines. A suitable dummy load for the 52-ohm line can be made of four 220 ohm, 2 watt composition resistors (*Ohmite "Little Devil"*) connected in parallel. Clip the leads of the resistors short and mount them on a coaxial plug. This assembly provides an eight watt, 55 ohm load, suitable for use at 30 Mc. If an accurate ohmmeter is at hand, the resistors may be hand picked to obtain four 208 ohm units, thus making the dummy load resistors exactly 52 ohms. For all practical purposes, the 55 ohm load is satisfactory. A 75 ohm, eight watt load resistor may be made of four 300 ohm, 2 watt composition resistors connected in parallel.

R-f power is coupled to the reflectometer and the dummy load is placed in the "output" receptacle. The indicator meter is switched to the "reflected power" position. The meter reading should be almost zero. It may be brought to zero by removing the case of the instrument and adjusting the position of the load resistor. The actual length of wire in the resistor lead and its positioning determine the meter null. Replace the case before power is applied to the reflectometer. The reflectometer is now reversed and power is applied to the "output" receptacle, with a dummy load attached to the "input" receptacle. The second voltmeter (forward power) is adjusted for a null reading of the meter in the same manner.

If a reflected reading of zero is not obtainable, the harmonic content of the r-f source might be causing a slight residual meter reading. Coupling the reflectometer to the r-f source through a tuned circuit ("antenna tuner") will remove the offending harmonic and permit an accurate null indication. Be sure to hold the r-f input power to a low value to prevent overheating the dummy load resistors.

Using the Reflectometer The bridge may be used up to 150 Mc. It is placed in the transmission line at a convenient point, preferably *before* any tuner, balun, or TVI filter. The indicator should be set to read forward power, with a maximum of resistance in the circuit. Power is applied and the indicator resistor is adjusted for a full scale reading. The switch is then thrown to read reflected power (indicated as A, figure 14). Assume that the forward power meter reading is 1.0 and the reflected power reading is 0.5. Substituting these values in the SWR formula of figure 14 shows the SWR to be 3. If forward power is always set to 1.0 on the meter, the reflected power (A) can be read directly from the curve of figure 14 with little error.

If the meter is adjusted so as to provide a half-scale reading of the forward power, the reflectometer may be used as a transmitter power output meter. Tuning adjustments may then be undertaken to provide greatest meter reading.

34-7 Measurements on Balanced Transmission Lines

Measurements made on balanced transmission lines may be conducted in the same manner as those made on coaxial lines. In the case of the coaxial lines, care must be taken to prevent flow of r-f current on the outer surface of the line as this unwanted component will introduce errors in measurements made on the line. In like fashion, the currents in a balanced transmission line must be 180 degrees out of phase and balanced with respect to ground in order to obtain a realistic relationship between incident and reflected power. This situation is not always easy to obtain in practice because of the proximity effects of metallic objects or the earth to the transmission line. All transmission line measurements, therefore, should be conducted with the realization of the physical limitations

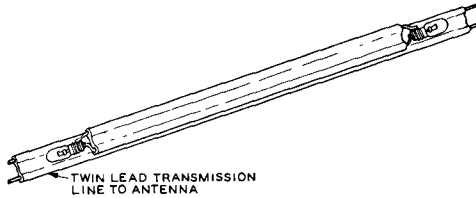

Figure 17

SKETCH OF THE "TWIN-LAMP" TYPE OF S-W-R INDICATOR

The short section of line with lamps at each end usually is taped to the main transmission line with plastic electrical tape.

of the equipment and the measuring technique that is being used.

Measurements on Molded Parallel-Wire Lines One of the most satisfactory and least expensive devices for obtaining a rough idea

of the standing-wave ratio on a transmission line of the molded parallel-wire type is the *twin-lamp*. This ingenious instrument may be constructed of new components for a total cost of about 25 cents; this fact alone places the twin-lamp in a class by itself as far as test instruments are concerned.

Figure 17 shows a sketch of a twin-lamp indicator. The indicating portion of the system consists merely of a length of 300-ohm Twin-Lead about 10 inches long with a dial lamp at each end. In the unit illustrated the dial lamps are standard 6.3-volt 150-ma. bayonet-base lamps. The lamps are soldered to the two leads at each end of the short section of Twin-Lead.

To make a measurement the short section of line with the lamps at each end is merely taped to the section of Twin-Lead (or other similar transmission line) running from the transmitter or from the antenna changeover relay to the antenna system. When there are no standing waves on the antenna transmission line the lamp toward the transmitter will light while the one toward the antenna will not light. With 300-ohm Twin-Lead running from the antenna changeover relay to the antenna, and with about 200 watts input on the 28-Mc. band, the dial lamp toward the transmitter will light nearly to full brilliancy. With a standing-wave ratio of about 1.5 to 1 on the transmission line to the antenna the lamp toward the antenna will just begin to light. With a high standing-wave ratio on the antenna feed line both lamps will light nearly to full brilliancy. Hence the instrument gives an indication of relatively low standing waves, but when the



Figure 18

OPERATION OF THE "TWIN LAMP" INDICATOR

Showing current flow resulting from inductive and capacitive fields in a "twin lamp" attached to a line with a low standing-wave ratio.

standing-wave ratio is high the twin-lamp merely indicates that they are high without giving any idea of the actual magnitude.

Operation of the Twin-Lamp

The twin lamp operates by virtue of the fact that the capacitive and inductive coupling of the wire making up one side of the twin-lamp is much greater to the transmission-line lead immediately adjacent to it than to the transmission-line lead on the other side. The same is of course true of the wire on the other side of the twin-lamp and the transmission-line lead adjacent to it. A further condition which must be met for the twin-lamp to operate is that the section of line making up the twin-lamp must be short with respect to a quarter wavelength. Then the current due to capacitive coupling passes through both lamps in the same direction, while the current due to inductive coupling between the leads of the twin-lamp and the leads of the antenna transmission line passes through the two lamps in opposite directions. Hence, in a line without reflections, the two currents will cancel in one lamp while the other lamp is lighted due to the sum of the currents (figure 18).

The basic fact which makes the twin-lamp a *directional coupler* is a result of the condition whereby the capacitive coupling is a *scalar* action not dependent upon the direction of the waves passing down the line, yet the inductive coupling is a *vector* action which is dependent upon the direction of wave propagation down the line. Thus the capacitive current is the same and is in the same phase for energy travelling in either direction down the line. But the inductive current travels in one direction for energy travelling in one direction and in the other direction for energy going the other direction. Hence the two currents add at one end of the line for a wave passing toward the antenna, while the currents add at the other end of the twin-lamp for the waves reflected from the antenna. When the waves are

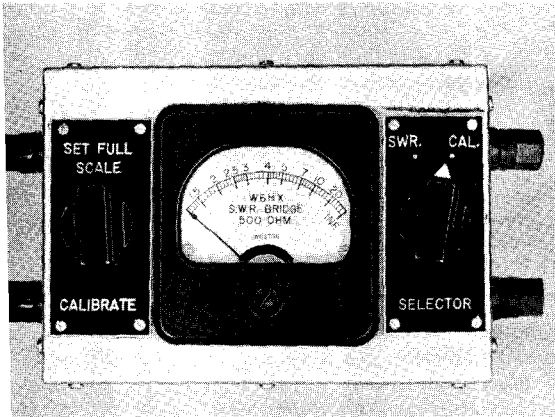

Figure 19
SWR BRIDGE FOR BALANCED TRANSMISSION LINE

A double bridge can be used for two wire transmission lines. Bridge is inserted in line and may be driven with grid-dip oscillator or other low power r-f source.

strongly reflected upon reaching the antenna, the reflected wave is nearly the same as the direct wave, and both lamps will light. This condition of strong reflection from the antenna system is that which results in a high standing-wave ratio on the antenna feed line.

Use of the Twin Lamp with Various Feed Lines

The twin-lamp is best suited for use with antenna transmission lines of the flat ribbon type.

Lines with a high power rating are available in impedances of 75 ohms, 205 ohms, and 300 ohms in the flat ribbon type. In addition, one manufacturer makes a 300-ohm line in two power-level ratings with a tubular cross section. A twin-lamp made from flat 300-ohm line may be used with this tubular line by taping the twin-lamp tightly to the tubular line so that the conductors of the twin-lamp are as close as possible on each side of the conductors of the antenna line.

34-8 A "Balanced" SWR Bridge

Two resistor-type standing wave indicators may be placed "back-to-back" to form a SWR bridge capable of being used on two wire balanced transmission lines. Such a bridge is shown in figures 19 and 21. The schematic of such an instrument (figure 20) may be compared to two of the simple bridges shown in figure 13. When the dual bridge circuit is balanced the meter reading is zero. This state is reached when the line currents are equal and exactly 180 degrees out of phase and the SWR is unity.

As the condition of the line departs from the optimum, the meter of the bridge will

show the degree of departure. When the line currents are balanced and 180 degrees out of phase, the meter will read the true value of standing wave ratio on the line. If these conditions are not met, the reading is not absolute, merely giving an indication of the degree of mis-match in the line. This handicap is not important, since the relative, not the absolute, degree of mis-match is sufficient for transmission line adjustments to be made.

Bridge Construction A suggested method of construction of the balanced bridge is illustrated in figures 19 and 21. The unit is constructed within a box measuring 4" x 6" x 2" in size. The 0 - 200 d.c. microammeter is placed in the center of the 4" x 6" side of the case. The input and output connectors of the instrument are placed on each end of the box and the internal wiring is arranged so that the transmission line, in effect, passes in one side of the box and out the other with as little discontinuity as possible. The input and output terminals are mounted on phenolic plates placed over large cut-outs in the ends of the box, thus reducing circuit capacity to ground to a minimum value. The "SWR-CAL" switch S_1 is located on one side of the meter and the "Calibrate" potentiometer R_1 is placed on the opposite side.

The transmission line within the unit is

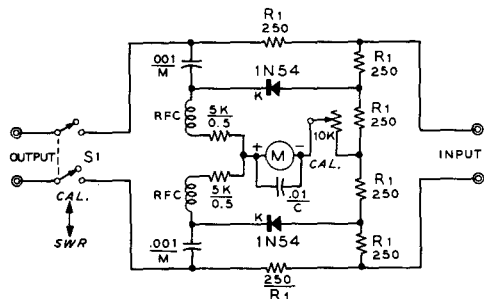
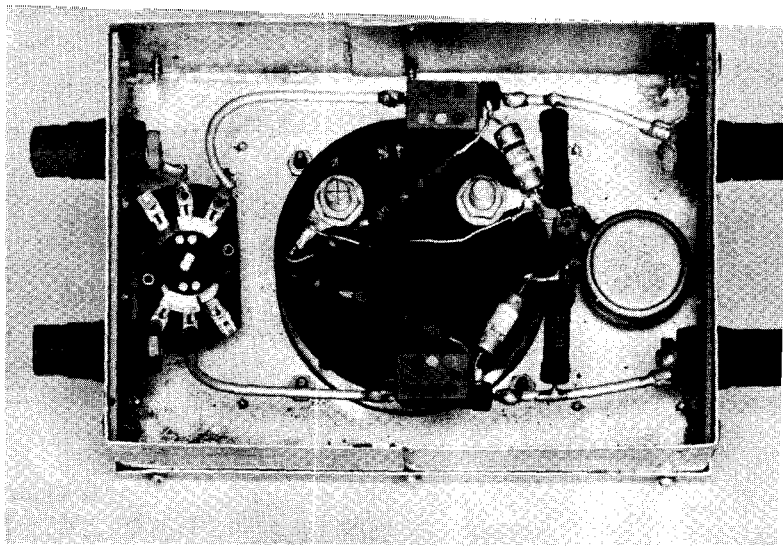

Figure 20
SCHEMATIC OF BRIDGE FOR BALANCED LINES

M—0-200 d-c microammeter
R—Note: Six 250 ohm resistors are composition, non-inductive units. IRC type BT, or Ohmite "Little Devil" 1-watt resistors may be used. (see text)
S—DPDT rotary switch. Centralab type 1464

Figure 21
INTERIOR VIEW OF
BALANCED BRIDGE
SHOWING PARTS
PLACEMENT

Diode rectifiers are placed at right angles to the short section of transmission line. Both sides of bridge are balanced to ground by virtue of symmetrical construction of unit.



broken by two 250 ohm composition resistors and switch S_1 . The line segments are made of short pieces of #10 copper wire, running between the various components. Spacing between the wires is held close to three inches to approximate a 500-600 ohm line.

The small components of the bridge are placed symmetrically about the 250 ohm series line resistors and the calibrating potentiometer, as can be seen in figure 21. Exact parts placement is not critical, except that the crystal diodes should be placed at right angles to the wires of the transmission line to reduce capacitive pickup. The two r-f chokes should then be placed at right angles to the diodes.

The six 250 ohm resistors are checked on an ohmmeter and should be hand-picked to obtain units that are reasonably close in value. If it is desired to use the bridge with a 600 ohm line, the value of these resistors should be increased to 300 ohms each. Excessive heat should not be used in soldering either the resistors or the diodes to ensure that their characteristics will not be altered by application of high temperatures over an extended period.

Testing the Balanced Bridge

When the instrument is completed, a grid-dip meter may be coupled to the input terminals via a two turn link. Be careful not to pin the bridge meter. Place switch S_1 in the "Calibrate" (open) position. Set the grid dip meter in the 10-Mc. to 20-Mc. range and adjust the link and calibration control R_1 for full scale meter reading. A 500 ohm carbon resistor placed across the output terminals of the unit should produce a zero meter reading when S_1 is set to the "SWR" position. Various values of resistance may now be placed across the meter terminals to obtain calibration points

for the meter scale. The ratio of the external resistor to the design value of the bridge will provide the SWR value for any given meter reading. For example, a 1000 ohm resistor has a ratio of 1000/500, and will give an indicated SWR reading of 2. A 1500 ohm resistor will give an indicated reading of 3, a 2000 ohm resistor will provide a reading of 4, and so on. Before each measurement is recorded, the calibrate control should be set to a full scale reading with S_1 open.

This simple system of calibration will lead to slight errors in calibration if the regulation of the r-f source is poor. That is, a change in the external calibrating resistance will produce a varying load on the r-f generator which could easily cause a change in the power applied to the bridge. A separate diode r-f voltmeter placed across the pickup loop will enable the input voltage to be held to a constant value and will provide somewhat more accurate bridge calibration.

Using the Bridge

The bridge is placed in the transmission line and driven from a low powered source having a minimum of harmonic content. Several measurements should be made at various frequencies within the range of antenna operation. The selector switch is set to the "Cal." position and the "Calibrate" potentiometer is adjusted for full scale meter reading. The switch is then set to the "SWR" position and a reading is taken. This reading and others taken at various frequencies may be plotted on a graph to provide a "SWR curve" for the particular antenna and transmission line. Antenna adjustments and line balancing operations may now be conducted to provide a smooth SWR curve,

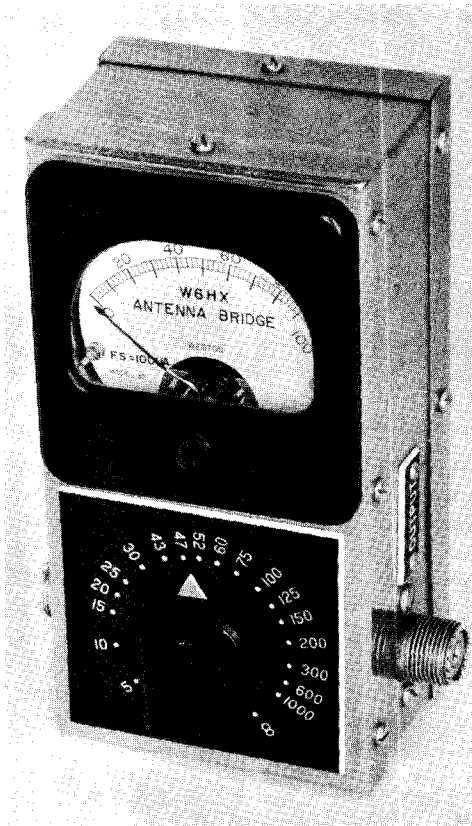

Figure 22
THE ANTENNASCOPE

The radiation resistance of r-f loads connected across the output receptacle may be quickly determined by a direct dial reading. The Antennascope may be driven with a grid-dip oscillator, covering r-f impedance range of 5 to 1000 ohms.

with the point of minimum SWR occurring at the chosen design frequency of the antenna installation. The complete adjustment and check-out procedure for an antenna and transmission line system is covered in the *Beam Antenna Handbook*, published by Radio Publications, Inc., Wilton, Conn.

34-9 The Antennascope

The *Antennascope* is a modified SWR bridge in which one leg of the bridge is composed of a non-inductive variable resistor. This resistor is calibrated in ohms, and when its setting is equal to the radiation resistance of the antenna under test the bridge is in a balanced state. If a sensitive voltmeter is con-

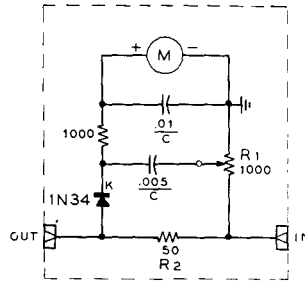

Figure 23
SCHEMATIC, ANTENNASCOPE

- R₁—1000 ohm composition potentiometer ohmite type AB or Allen Bradley type J, linear taper
- R₂—50 ohm, 1-watt composition resistor, IRC type BT, or ohmite "Little Devil" (see text)
- M—0-200 d-c microammeter

nected across the bridge, it will indicate a voltage null at bridge balance. The radiation resistance of the antenna may then be read directly from the calibrated resistor of the instrument.

When the antenna under test is in a non-resonant or reactive state, the null indication on the meter of the Antennascope will be incomplete. The frequency of the exciting signal must then be moved to the resonant frequency of the antenna to obtain accurate readings of radiation resistance from the dial of the instrument.

A typical Antennascope is shown in figures 22 and 24, and the schematic is shown in figure 23. A 1000 ohm non-inductive carbon potentiometer serves as the variable leg of the bridge. The other legs are composed of the 50 ohm composition resistor and the radiation resistance of the antenna. If the radiation resistance of the external load or antenna is 50 ohms and the potentiometer is set at mid-scale the bridge is in balance and the diode voltmeter will read zero. If the radiation resistance of the antenna is any value other than 50 ohms, the bridge may be balanced to this new value by varying the position of the potentiometer. Bridge balance may be obtained with non-reactive loads in the range of 5 ohms to 1000 ohms with this simple circuit. When measurements are conducted at the resonant frequency of the antenna system the radiation resistance of the installation may be read directly from the calibrated dial of the Antennascope. Conversely, a null reading of the instrument will occur at the resonant frequency, which may easily be found with the aid of a calibrated receiver or frequency meter.

Constructing the Antennascope The Antennascope is built within a sheet metal case measuring 3" x 6" x 2".

The indicating meter is placed at the top of the case, and the r-f bridge occupies the lower portion of the box. The input and output coaxial fittings are mounted on each side of the box and the non-inductive 50 ohm resistor is soldered between the center terminals of the receptacles.

The calibrating potentiometer (R₁) is mounted upon a phenolic plate placed over a 3/4-inch hole drilled in the front of the box. This reduces the capacity to ground of the potentiometer to a minimum. Placement of the small components within the box may be seen in figure 24. Care should be taken to mount the crystal diode at right angles to the 50 ohm resistor to reduce capacity coupling between the components.

The upper frequency limit of accuracy of the Antennascope is determined by the assembly technique. The unit shown will work with good accuracy to approximately 100 Mc. Above this frequency, the self-inductance of the leads prevents a perfect null from being obtained. For operation in the VHF region, it would be wise to rearrange the components to reduce lead length to an absolute minimum, and to use 1/4-inch copper strap for the r-f leads instead of wire.

Testing the Antennascope When the instrument is completed, a grid-dip meter may be coupled to the input receptacle of the Antennascope by means of a two turn link. The frequency of excitation should be in the 10 Mc.-20 Mc. region. Coupling should be adjusted to obtain a half-scale reading of the meter. Various values of 1-watt composition resistors up to 1000 ohms are then plugged into the "output" coaxial receptacle and the potentiometer is adjusted for a null on the meter. The settings of the potentiometer may now be calibrated in terms of the load resistor, the null position indicating the value of the test resistor. A calibrated scale for the potentiometer should be made, as shown in figure 22.

Using the Antennascope The antennascope may be driven by a grid-dip oscillator coupled to it by a two turn link. Enough coupling should be used to obtain at least a 3/4 scale reading on the meter of the Antennascope with no load connected to the measuring terminals. The Antennascope may be considered to be a low range r-f ohm-

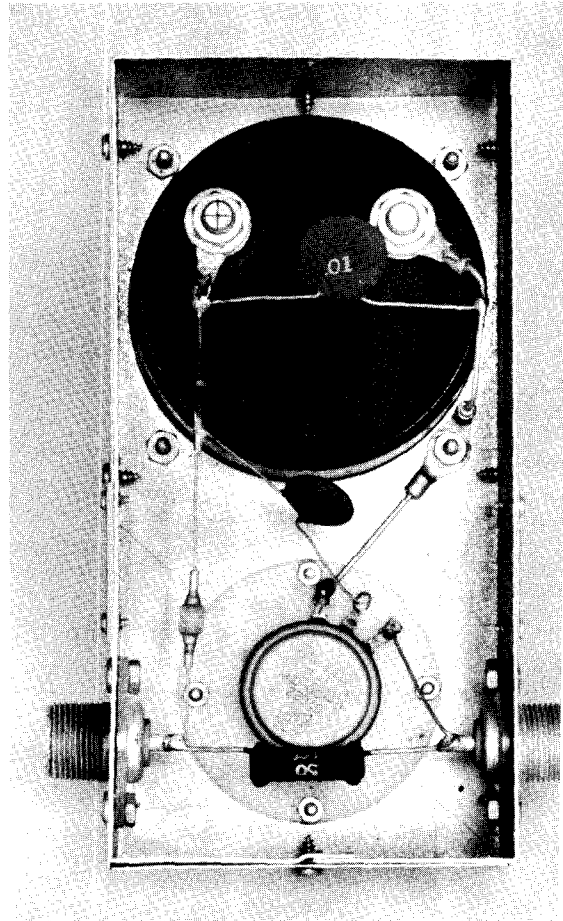

Figure 24
PLACEMENT OF PARTS WITHIN THE ANTENNASCOPE

With the length of leads shown this model is useful up to about 100 Mc. Crystal diode should be placed at right angles to 50 ohm composition resistor.

meter and may be employed to determine the electrical length of quarter-wave lines, surge impedance of transmission lines, and antenna resonance and radiation resistance.

In general, the measuring terminals of the Antennascope are connected in series with the load at a point of maximum current. This means the center of a dipole, or the base of a vertical 1/4-wave ground plane antenna. Excitation is supplied to the Antennascope, and the frequency of excitation and the resistance control of the Antennascope are both varied until a complete null is obtained on the indicating meter of the Antennascope. The frequency of

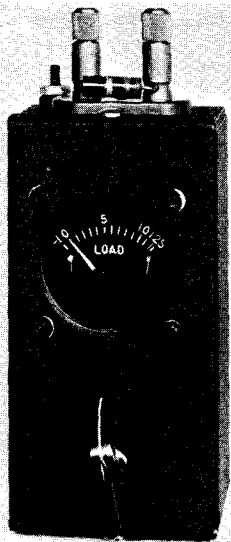

Figure 25
SIMPLE SILICON CRYSTAL NOISE
GENERATOR

the source of excitation is now the resonant frequency of the load, and the radiation resistance of the load may be read upon the dial of the Antennascope.

On measurements on 80 and 40 meters, it might be found that it is impossible to obtain a complete null on the Antennascope. This is usually caused by pickup of a nearby broadcast station, the rectified signal of the broadcast station obscuring the null indication on the Antennascope. This action is only noticed when antennas of large size are being checked.

34-10 A Silicon Crystal Noise Generator

The limiting factor in signal reception above 25 Mc. is usually the thermal noise generated in the receiver. At any frequency, however, the tuned circuits of the receiver must be accurately aligned for best signal-to-noise ratio. Circuit changes (and even alignment changes) in the r-f stages of a receiver may do much to either enhance or degrade the noise figure of the receiver. It is exceedingly hard to determine whether changes of either alignment or circuitry are really providing a boost in signal-to-noise ratio of the receiver, or are merely increasing the gain (and noise) of the unit.

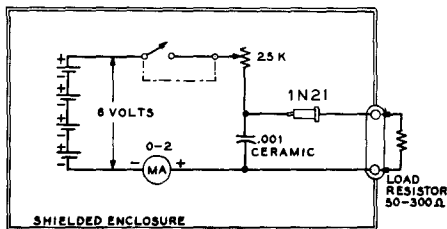

A SILICON CRYSTAL NOISE GENERATOR

Figure 26

A simple means of determining the degree of actual sensitivity of a receiver is to inject a minute signal in the input circuit and then measure the amount of this signal that is needed to overcome the inherent receiver noise. The less injected signal needed to override the receiver noise by a certain, fixed amount, the more sensitive is the receiver.

A simple source of minute signal may be obtained from a silicon crystal diode. If a small d-c current is passed through a silicon crystal in the direction of highest resistance, a small but constant r-f noise (or hiss) is generated. The voltage necessary to generate this noise may be obtained from a few flashlight cells. The generator is a broad band device and requires no tuning. If built with short leads, it may be employed for receiver measurements well above 150 Mc. The noise generator should be used for comparative measurements only, since calibration against a high quality commercial noise generator is necessary for absolute measurements.

A Practical Noise Generator Shown in figure 25 is a simple silicon crystal noise generator. The schematic of this unit is illustrated in figure 26. The 1N21 crystal and .001 μ fd. ceramic capacitor are connected in series directly across the output terminals of the instrument. Three small flashlight batteries are wired in series and mounted inside the case, along with the 0-2 d-c milliammeter and the noise level potentiometer.

To prevent heat damage to the 1N21 crystal during the soldering process, the crystal should be held with a damp rag, and the connections soldered to it quickly with a very hot iron. Across the terminals (and in parallel with the equipment to be attached to the generator) is a 1-watt carbon resistor whose resistance is equal to the impedance level at which measurements are to be made. This will usually be either 50 or 300 ohms. If the noise generator is to be used at one impedance level only, this

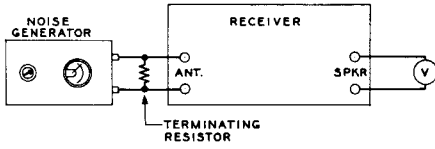

TEST SET-UP FOR NOISE GENERATOR

Figure 27

resistor may be mounted permanently inside of the case.

Using the Noise Generator

The test setup for use of the noise generator is shown in figure 27. The noise gen-

erator is connected to the antenna terminals of the receiver under test. The receiver is turned on, the a.v.c. turned off, and the r-f gain control placed full on. The audio volume control is adjusted until the output meter advances to one-quarter scale. This reading is the basic receiver noise. The noise generator is turned on, and the noise level potentiometer adjusted until the noise output voltage of the receiver is doubled. The more resistance in the diode circuit, the better is the signal-to-noise ratio of the receiver under test. The r-f circuits of the receiver may be aligned for maximum signal-to-noise ratio with the noise generator by aligning for a 2/1 noise ratio at minimum diode current.

Radio Mathematics and Calculations

Radiomen often have occasion to calculate sizes and values of required parts. This requires some knowledge of mathematics. The following pages contain a review of those parts of mathematics necessary to understand and apply the information contained in this book. It is assumed that the reader has had some mathematical training; this chapter is not intended to teach those who have never learned anything of the subject.

Fortunately only a knowledge of fundamentals is necessary, although this knowledge must include several branches of the subject. Fortunately, too, the majority of practical applications in radio work reduce to the solution of equations or formulas or the interpretation of graphs.

Arithmetic

Notation of Numbers In writing numbers in the Arabic system we employ ten different symbols, digits, or figures: 1, 2, 3, 4, 5, 6, 7, 8, 9, and 0, and place them in a definite sequence. If there is more than one figure in the number the *position* of each figure or digit is as important in determining its value as is the digit itself. When we deal with whole numbers the righthandmost digit represents units, the next to the left represents tens, the next hundreds, the next thousands, from which we derive the rule that every time a digit is placed one space further to the left its value is multiplied by ten.

8	1	4	3
thousands	hundreds	tens	units

It will be seen that any number is actually a sum. In the example given above it is the sum of eight thousands, plus one hundred, plus

four tens, plus three units, which could be written as follows:

8	thousands ($10 \times 10 \times 10$)
1	hundreds (10×10)
4	tens
3	units
8143	

The number in the units position is sometimes referred to as a *first order* number, that in the tens position is of the *second order*, that in the hundreds position the *third order*, etc.

The idea of letting the position of the symbol denote its value is an outcome of the abacus. The abacus had only a limited number of wires with beads, but it soon became apparent that the quantity of symbols might be continued indefinitely towards the left, each further space multiplying the digit's value by ten. Thus any quantity, however large, may readily be indicated.

It has become customary for ease of reading to divide large numbers into groups of three digits, separating them by commas.

6,000,000 rather than 6000000

Our system of notation then is characterized by two things: the use of positions to indicate the value of each symbol, and the use of ten symbols, from which we derive the name *decimal system*.

Retaining the same use of positions, we might have used a different number of symbols, and displacing a symbol one place to the left might multiply its value by any other factor such as 2, 6 or 12. Such other systems have been in use in history, but will not be discussed here. There are also systems in which displacing a symbol to the left multiplies its value by

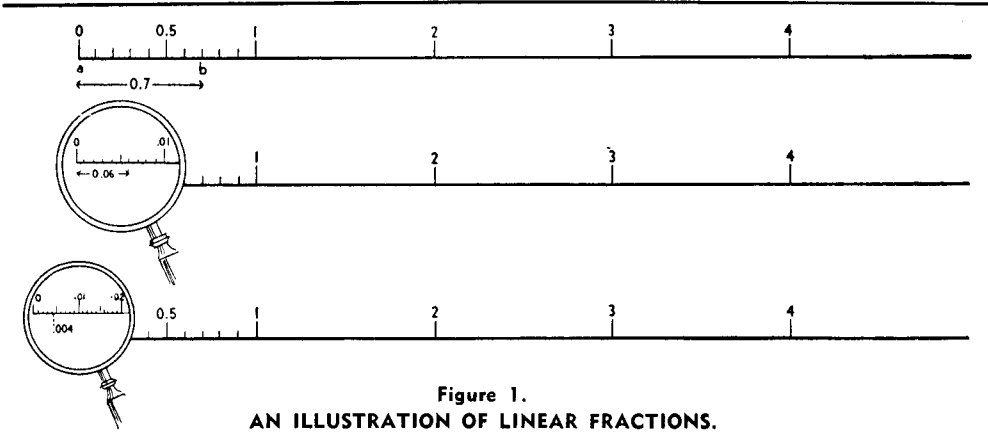

Figure 1.
AN ILLUSTRATION OF LINEAR FRACTIONS.

varying factors in accordance with complicated rules. The English system of measurements is such an inconsistent and inferior system.

Decimal Fractions Since we can extend a number indefinitely to the left to make it bigger, it is a logical step to extend it towards the right to make it smaller. Numbers smaller than unity are *fractions* and if a displacement one position to the right divides its value by ten, then the number is referred to as a *decimal fraction*. Thus a digit to the right of the units column indicates the number of *tenths*, the second digit to the right represents the number of *hundredths*, the third, the number of *thousandths*, etc. Some distinguishing mark must be used to divide unit from tenths so that one may properly evaluate each symbol. This mark is the *decimal point*.

A decimal fraction like *four-tenths* may be written .4 or 0.4 as desired, the latter probably

being the clearer. Every time a digit is placed one space further to the right it represents a ten times smaller part. This is illustrated in Figure 1, where each large division represents a unit; each unit may be divided into ten parts although in the drawing we have only so divided the first part. The length *ab* is equal to seven of these tenth parts and is written as 0.7.

The next smaller divisions, which should be written in the second column to the right of the decimal point, are each one-tenth of the small division, or one one-hundredth each. They are so small that we can only show them by imagining a magnifying glass to look at them, as in Figure 1. Six of these divisions is to be written as 0.06 (six hundredths). We need a microscope to see the next smaller division, that is those in the third place, which will be a tenth of one one-hundredth, or a thousandth; four such divisions would be written as 0.004 (four thousandths).

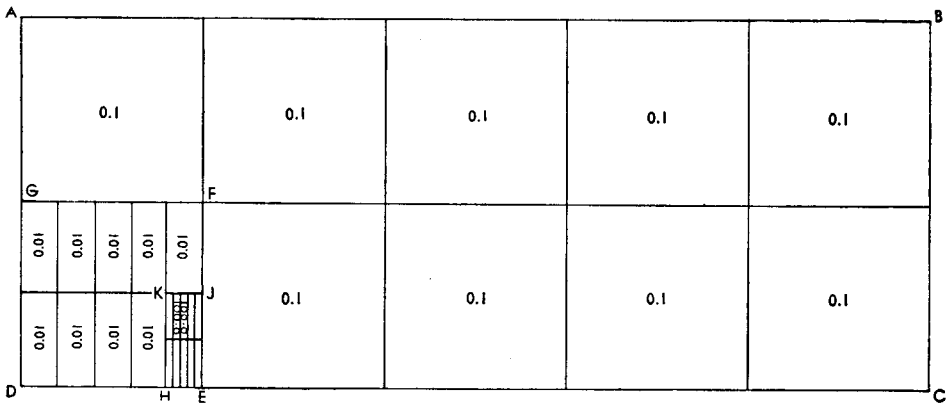

Figure 2.
IN THIS ILLUSTRATION FRACTIONAL PORTIONS ARE REPRESENTED IN THE FORM OF RECTANGLES RATHER THAN LINEARLY.
ABCD = 1.0; GFED = 0.1; KJHE = 0.01; each small section within KJHE equals 0.001.

It should not be thought that such numbers are merely of academic interest for very small quantities are common in radio work.

Possibly the conception of fractions may be clearer to some students by representing it in the form of rectangles rather than linearly (see Figure 2).

Addition When two or more numbers are to be added we sometimes write them horizontally with the plus sign between them. + is the sign or *operator* indicating addition. Thus if 7 and 12 are to be added together we may write $7+12=19$.

But if larger or more numbers are to be added together they are almost invariably written one under another in such a position that the decimal points fall in a vertical line. If a number has no decimal point, it is still considered as being just to the right of the units figure; such a number is a whole number or *integer*. Examples:

$\begin{array}{r} 654 \\ 32 \\ \hline 53041 \end{array}$	$\begin{array}{r} 0.654 \\ 3.2 \\ \hline 53.041 \end{array}$	$\begin{array}{r} 654 \\ 32 \\ \hline 5304.1 \end{array}$
53727	56.895	5990.1

The result obtained by adding numbers is called the *sum*.

Subtraction Subtraction is the reverse of addition. Its operator is - (the *minus* sign). The number to be subtracted is called the *minuend*, the number from which it is subtracted is the *subtrahend*, and the result is called the *remainder*.

$$\begin{array}{r} \text{subtrahend} \\ - \text{minuend} \\ \hline \text{remainder} \end{array}$$

Examples:

$\begin{array}{r} 65.4 \\ -32 \\ \hline 33.4 \end{array}$	$\begin{array}{r} 65.4 \\ -32.21 \\ \hline 33.19 \end{array}$
---	---

Multiplication When numbers are to be multiplied together we use the \times , which is known as the *multiplication* or the *times* sign. The number to be multiplied is known as the *multiplicand* and that by which it is to be multiplied is the *multiplier*, which may be written in words as follows:

$$\begin{array}{r} \text{multiplicand} \\ \times \text{multiplier} \\ \hline \text{partial product} \\ \text{partial product} \\ \hline \text{product} \end{array}$$

The result of the operation is called the *product*.

From the examples to follow it will be obvious that there are as many partial products as there are digits in the multiplier. In the following examples note that the righthandmost digit of each partial product is placed one space farther to the left than the previous one.

$\begin{array}{r} 834 \\ \times 26 \\ \hline 5004 \\ 1668 \\ \hline 21684 \end{array}$	$\begin{array}{r} 834 \\ \times 206 \\ \hline 5004 \\ 000 \\ 1668 \\ \hline 171804 \end{array}$
--	---

In the second example above it will be seen that the inclusion of the second partial product was unnecessary; whenever the multiplier contains a cipher (zero) the next partial product should be moved an *additional* space to the left.

Numbers containing decimal fractions may first be multiplied exactly as if the decimal point did not occur in the numbers at all; the position of the decimal point in the product is determined after all operations have been completed. It must be so positioned in the product that the number of digits to its right is equal to the number of decimal places in the multiplicand plus the number of decimal places in the multiplier.

This rule should be well understood since many radio calculations contain quantities which involve very small decimal fractions. In the examples which follow the explanatory notations "2 places," etc., are not actually written down since it is comparatively easy to determine the decimal point's proper location mentally.

$\begin{array}{r} 5.43 \\ \times 0.72 \\ \hline 1086 \\ 3801 \\ \hline 3.9096 \end{array}$	2 places 2 places 2 + 2 = 4 places
$\begin{array}{r} 0.04 \\ \times 0.003 \\ \hline 0.0012 \end{array}$	2 places 3 places 2 + 3 = 5 places

Division Division is the reverse of multiplication. Its operator is the \div , which is called the *division sign*. It is also common to indicate division by the use of the fraction bar (/) or by writing one number over the other. The number which is to be divided is called the *dividend* and is written before the division sign or fraction bar or over the horizontal line indicating a fraction. The num-

ber by which the dividend is to be divided is called the *divisor* and follows the division sign or fraction bar or comes under the horizontal line of the fraction. The answer or result is called the *quotient*.

$$\begin{array}{r} \text{quotient} \\ \text{divisor} \overline{) \text{dividend}} \\ \text{or} \\ \text{dividend} \div \text{divisor} = \text{quotient} \\ \text{or} \\ \frac{\text{dividend}}{\text{divisor}} = \text{quotient} \end{array}$$

Examples:

$$\begin{array}{r} 126 \\ 834 \overline{) 105084} \\ \underline{834} \\ 2168 \\ \underline{1668} \\ 5004 \\ \underline{5004} \end{array} \qquad \begin{array}{r} 49 \\ 49 \overline{) 2436} \\ \underline{196} \\ 476 \\ \underline{441} \\ 35 \text{ remainder} \end{array}$$

Note that one number often fails to divide into another evenly. Hence there is often a quantity left over called the *remainder*.

The rules for placing the decimal point are the reverse of those for multiplication. The number of decimal places in the quotient is equal to the difference between the number of decimal places in the dividend and that in the divisor. It is often simpler and clearer to remove the decimal point entirely from the divisor by multiplying both dividend and divisor by the necessary factor; that is we move the decimal point in the divisor as many places to the right as is necessary to make it a whole number and then we move the decimal point in the dividend exactly the same number of places to the right regardless of whether this makes the dividend a whole number or not. When this has been done the decimal point in the quotient will automatically come directly above that in the dividend as shown in the following example.

Example: Divide 10.5084 by 8.34. Move the decimal point of both dividend and divisor two places to the right.

$$\begin{array}{r} 1.26 \\ 834 \overline{) 1050.84} \\ \underline{834} \\ 2168 \\ \underline{1668} \\ 5004 \\ \underline{5004} \end{array}$$

Another example: Divide 0.000325 by 0.017. Here we must move the decimal point three places to the right in both dividend and divisor.

$$\begin{array}{r} 0.019 \\ 17 \overline{) 0.325} \\ \underline{17} \\ 155 \\ \underline{153} \\ 2 \end{array}$$

In a case where the dividend has fewer decimals than the divisor the same rules still may be applied by adding ciphers. For example to divide 0.49 by 0.006 we must move the decimal point three places to the right. The 0.49 now becomes 490 and we write:

$$\begin{array}{r} 81 \\ 6 \overline{) 490} \\ \underline{48} \\ 10 \\ \underline{6} \\ 4 \end{array}$$

When the division shows a remainder it is sometimes necessary to continue the work so as to obtain more figures. In that case ciphers may be annexed to the dividend, brought down to the remainder, and the division continued as long as may be necessary; be sure to place a decimal point in the dividend before the ciphers are annexed if the dividend does not already contain a decimal point. For example:

$$\begin{array}{r} 80.33 \\ 6 \overline{) 482.00} \\ \underline{48} \\ 20 \\ \underline{18} \\ 20 \\ \underline{18} \\ 2 \end{array}$$

This operation is not very often required in radio work since the accuracy of the measurements from which our problems start seldom justifies the use of more than three significant figures. This point will be covered further later in this chapter.

Fractions Quantities of less than one (unity) are called *fractions*. They may be expressed by decimal notation as we have seen, or they may be expressed as *vulgar fractions*. Examples of vulgar fractions:

$$\frac{\text{numerator}}{\text{denominator}} \quad \frac{3}{4} \quad \frac{6}{7} \quad \frac{1}{5}$$

The upper position of a vulgar fraction is called the *numerator* and the lower position the *denominator*. When the numerator is the smaller of the two, the fraction is called a *proper fraction*; the examples of vulgar fractions given above are proper vulgar fractions. When the numerator is the larger, the expression is an *improper fraction*, which can be reduced to an integer or whole number with a proper fraction, the whole being called a mixed number. In the following examples improper fractions have been reduced to their corresponding mixed numbers.

$$\frac{7}{4} = 1\frac{3}{4} \qquad \frac{5}{3} = 1\frac{2}{3}$$

Adding or Subtracting Fractions

Except when the fractions are very simple it will usually be found much easier to add and subtract fractions in the form of decimals. This rule likewise applies for practically all other operations with fractions. However, it is occasionally necessary to perform various operations with vulgar fractions and the rules should be understood.

When adding or subtracting such fractions the denominators must be made equal. This may be done by multiplying both numerator and denominator of the first fraction by the denominator of the other fraction, after which we multiply the numerator and denominator of the second fraction by the denominator of the first fraction. This sounds more complicated than it usually proves in practice, as the following examples will show.

$$\frac{1}{2} + \frac{1}{3} = \left[\frac{1 \times 3}{2 \times 3} + \frac{1 \times 2}{3 \times 2} \right] = \frac{3}{6} + \frac{2}{6} = \frac{5}{6}$$

$$\frac{3}{4} - \frac{2}{5} = \left[\frac{3 \times 5}{4 \times 5} - \frac{2 \times 4}{5 \times 4} \right] = \frac{15}{20} - \frac{8}{20} = \frac{7}{20}$$

Except in problems involving large numbers the step shown in brackets above is usually done in the head and is not written down.

Although in the examples shown above we have used proper fractions, it is obvious that the same procedure applies with improper fractions. In the case of problems involving mixed numbers it is necessary first to convert them into improper fractions. Example:

$$2\frac{3}{7} = \frac{2 \times 7 + 3}{7} = \frac{17}{7}$$

The numerator of the improper fraction is equal to the whole number multiplied by the denominator of the original fraction, to which

the numerator is added. That is in the above example we multiply 2 by 7 and then add 3 to obtain 17 for the numerator. The denominator is the same as is the denominator of the original fraction. In the following example we have added two mixed numbers.

$$2\frac{3}{7} + 3\frac{3}{4} = \frac{17}{7} + \frac{15}{4} = \left[\frac{17 \times 4}{7 \times 4} + \frac{15 \times 7}{4 \times 7} \right]$$

$$= \frac{68}{28} + \frac{105}{28} = \frac{173}{28} = 6\frac{5}{28}$$

Multiplying Fractions

All vulgar fractions are multiplied by multiplying the numerators together and the denominators together, as shown in the following example:

$$\frac{3}{4} \times \frac{2}{5} = \left[\frac{3 \times 2}{4 \times 5} \right] = \frac{6}{20} = \frac{3}{10}$$

As above, the step indicated in brackets is usually not written down since it may easily be performed mentally. As with addition and subtraction any mixed numbers should be first reduced to improper fractions as shown in the following example:

$$\frac{3}{23} \times 4\frac{1}{3} = \frac{3}{23} \times \frac{13}{3} = \frac{39}{69} = \frac{13}{23}$$

Division of Fractions

Fractions may be most easily divided by inverting the divisor and then multiplying.

Example:

$$\frac{2}{5} \div \frac{3}{4} = \frac{2}{5} \times \frac{4}{3} = \frac{8}{15}$$

In the above example it will be seen that to divide by $\frac{3}{4}$ is exactly the same thing as to multiply by $\frac{4}{3}$. Actual division of fractions is a rather rare operation and if necessary is usually postponed until the final answer is secured when it is often desired to reduce the resulting vulgar fraction to a decimal fraction by division. It is more common and usually results in least overall work to reduce vulgar fractions to decimals at the beginning of a problem. Examples:

$$\frac{3}{8} = 0.375 \qquad \frac{5}{32} = 0.15625$$

$$\begin{array}{r} 0.15625 \\ 32 \overline{) 5.00000} \\ \underline{32} \\ 180 \\ \underline{160} \\ 200 \\ \underline{192} \\ 80 \\ \underline{64} \\ 160 \\ \underline{160} \\ 0 \end{array}$$

It will be obvious that many vulgar fractions cannot be reduced to exact decimal equivalents. This fact need not worry us, however, since the degree of equivalence can always be as much as the data warrants. For instance, if we know that one-third of an ampere is flowing in a given circuit, this can be written as 0.333 amperes. This is not the exact equivalent of $1/3$ but is close enough since it shows the value to the nearest thousandth of an ampere and it is probable that the meter from which we secured our original data was not accurate to the nearest thousandth of an ampere.

Thus in converting vulgar fractions to a decimal we unhesitatingly stop when we have reached the number of significant figures warranted by our original data, which is very seldom more than three places (see section *Significant Figures* later in this chapter).

When the denominator of a vulgar fraction contains only the factors 2 or 5, division can be brought to a finish and there will be no remainder, as shown in the examples above.

When the denominator has other factors such as 3, 7, 11, etc., the division will seldom come out even no matter how long it is continued but, as previously stated, this is of no consequence in practical work since it may be carried to whatever degree of accuracy is necessary. The digits in the quotient will usually repeat either singly or in groups, although there may first occur one or more digits which do not repeat. Such fractions are known as *repeating fractions*. They are sometimes indicated by an oblique line (fraction bar) through the digit which repeats, or through the first and last digits of a repeating group. Example:

$$\frac{1}{3} = 0.3333 \dots = 0.\overline{3}$$

$$\frac{1}{7} = 0.142857142857 \dots = 0.\overline{142857}$$

The foregoing examples contained only repeating digits. In the following example a non-repeating digit precedes the repeating digit:

$$\frac{7}{30} = 0.2333 \dots = 0.2\overline{3}$$

While repeating decimal fractions can be converted into their vulgar fraction equivalents, this is seldom necessary in practical work and the rules will be omitted here.

Powers and Roots When a number is to be multiplied by itself we say that it is to be *squared* or to be *raised to the second power*. When it is to be multiplied by itself once again, we say that it is *cubed* or *raised to the third power*.

In general terms, when a number is to be multiplied by itself we speak of *raising to a power* or *involution*; the number of times which the number is to be multiplied by itself is called the *order of the power*. The standard notation requires that the order of the power be indicated by a small number written after the number and above the line, called the *exponent*. Examples:

$$2^2 = 2 \times 2, \text{ or } 2 \text{ squared, or the second power of } 2$$

$$2^3 = 2 \times 2 \times 2, \text{ or } 2 \text{ cubed, or the third power of } 2$$

$$2^4 = 2 \times 2 \times 2 \times 2, \text{ or the fourth power of } 2$$

Sometimes it is necessary to perform the reverse of this operation, that is, it may be necessary, for instance, to find that number which multiplied by itself will give a product of nine. The answer is of course 3. This process is known as *extracting the root* or *evolution*. The particular example which is cited would be written:

$$\sqrt{9} = 3$$

The sign for extracting the root is $\sqrt{\quad}$, which is known as the *radical sign*; the order of the root is indicated by a small number above the radical as in $\sqrt[4]{\quad}$, which would mean the fourth root; this number is called the *index*. When the radical bears no index, the square or second root is intended.

Restricting our attention for the moment to square root, we know that 2 is the square root of 4, and 3 is the square root of 9. If we want the square root of a number between 3 and 9, such as the square root of 5, it is obvious that it must lie between 2 and 3. In general the square root of such a number cannot be *exactly* expressed either by a vulgar fraction or a decimal fraction. However, the square root can be carried out decimally as far as may be necessary for sufficient accuracy. In general such a decimal fraction will contain a never-ending series of digits without repeating groups. Such a number is an *irrational number*, such as

$$\sqrt{5} = 2.2361 \dots$$

The extraction of roots is usually done by tables or logarithms the use of which will be described later. There are longhand methods of extracting various roots, but we shall give only that for extracting the square root since the others become so tedious as to make other methods almost invariably preferable. Even the longhand method for extracting the square root will usually be used only if loga-

rithm tables, slide rule, or table of roots are not handy.

Extracting the Square Root First divide the number the root of which is to be extracted into groups of two digits starting at the decimal point and going in both directions. If the lefthandmost group proves to have only one digit instead of two, no harm will be done. The righthandmost group may be made to have two digits by annexing a zero if necessary. For example, let it be required to find the square root of 5678.91. This is to be divided off as follows:

$$\sqrt{56' 78.91}$$

The mark used to divide the groups may be anything convenient, although the prime-sign (') is most commonly used for the purpose.

Next find the largest square which is contained in the first group, in this case 56. The largest square is obviously 49, the square of 7. Place the 7 above the first group of the number whose root is to be extracted, which is sometimes called the *dividend* from analogy to ordinary division. Place the square of this figure, that is 49, under the first group, 56, and subtract leaving a remainder of 7.

$$\begin{array}{r} 7 \\ \sqrt{56' 78.91} \\ 49 \\ \hline 7 \end{array}$$

Bring down the next group and annex it to the remainder so that we have 778. Now to the left of this quantity write down twice the root so far found (2×7 or 14 in this example), annex a cipher as a trial divisor, and see how many times the result is contained in 778. In our example 140 will go into 778 5 times. Replace the cipher with a 5, and multiply the resulting 145 by 5 to give 725. Place the 5 directly above the second group in the dividend and then subtract the 725 from 778.

$$\begin{array}{r} 7 \ 5 \\ \sqrt{56' 78.91} \\ 49 \\ \hline 140 \qquad 7 \ 78 \\ 145 \times 5 = \qquad 7 \ 25 \\ \hline \qquad \qquad \qquad 53 \end{array}$$

The next step is an exact repetition of the previous step. Bring down the third group and annex it to the remainder of 53, giving 5391. Write down twice the root already

found and annex the cipher (2×75 or 150 plus the cipher, which will give 1500). 1500 will go into 5391 3 times. Replace the last cipher with a three and multiply 1503 by 3 to give 4509. Place 3 above the third group. Subtract to find the remainder of 882. The quotient 75.3 which has been found so far is not the exact square root which was desired; in most cases it will be sufficiently accurate. However, if greater accuracy is desired groups of two ciphers can be brought down and the process carried on as long as necessary.

$$\begin{array}{r} 7 \ 5 \ 3 \\ \sqrt{56' 78.91} \\ 49 \\ \hline 140 \qquad 7 \ 78 \\ 145 \times 5 = \qquad 7 \ 25 \\ \hline 1500 \qquad 53 \ 91 \\ 1503 \times 3 = \qquad 45 \ 09 \\ \hline \qquad \qquad \qquad 8 \ 82 \end{array}$$

Each digit of the root should be placed directly above the group of the dividend from which it was derived; if this is done the decimal point of the root will come directly above the decimal point of the dividend.

Sometimes the remainder after a square has been subtracted (such as the 1 in the following example) will not be sufficiently large to contain twice the root already found even after the next group of figures has been brought down. In this case we write a cipher above the group just brought down and bring down another group.

$$\begin{array}{r} 7 \ 0 \ 8 \ 2 \\ \sqrt{50.16' 00' 00} \\ 49 \\ \hline 1400 \qquad 1 \ 16 \ 00 \\ 1408 \times 8 = \qquad 1 \ 12 \ 64 \\ \hline 14160 \qquad \qquad 3 \ 36 \ 00 \\ 14162 \times 2 = \qquad 2 \ 83 \ 24 \\ \hline \qquad \qquad \qquad 52 \ 76 \end{array}$$

In the above example the amount 116 was not sufficient to contain twice the root already found with a cipher annexed to it; that is, it was not sufficient to contain 140. Therefore we write a zero above 16 and bring down the next group, which in this example is a pair of ciphers.

Order of Operations One frequently encounters problems in which several of the fundamental operations of arithmetic which have been described are to be performed. The order in which these operations

must be performed is important. First all powers and roots should be calculated; multiplication and division come next; adding and subtraction come last. In the example

$$2 + 3 \times 4^2$$

we must first square the 4 to get 16; then we multiply 16 by 3, making 48, and to the product we add 2, giving a result of 50.

If a different order of operations were followed, a different result would be obtained. For instance, if we add 2 to 3 we would obtain 5, and then multiplying this by the square of 4 or 16, we would obtain a result of 80, which is incorrect.

In more complicated forms such as fractions whose numerators and denominators may both be in complicated forms, the numerator and denominator are first found separately before the division is made, such as in the following example:

$$\frac{3 \times 4 + 5 \times 2}{2 \times 3 + 2 + 3} = \frac{12 + 10}{6 + 2 + 3} = \frac{22}{11} = 2$$

Problems of this type are very common in dealing with circuits containing several inductances, capacities, or resistances.

The order of operations specified above does not always meet all possible conditions; if a series of operations should be performed in a different order, this is always indicated by *parentheses* or *brackets*, for example:

$$\begin{aligned} 2 + 3 \times 4^2 &= 2 + 3 \times 16 = 2 + 48 = 50 \\ (2 + 3) \times 4^2 &= 5 \times 4^2 = 5 \times 16 = 80 \\ 2 + (3 \times 4)^2 &= 2 + 12^2 = 2 + 144 = 146 \end{aligned}$$

In connection with the radical sign, brackets may be used or the "hat" of the radical may be extended over the entire quantity whose root is to be extracted. Example:

$$\begin{aligned} \sqrt{4 + 5} &= \sqrt{4} + 5 = 2 + 5 = 7 \\ \sqrt{(4 + 5)} &= \sqrt{4 + 5} = \sqrt{9} = 3 \end{aligned}$$

It is recommended that the radical always be extended over the quantity whose root is to be extracted to avoid any ambiguity.

Cancellation In a fraction in which the numerator and denominator consist of several factors to be multiplied, considerable labor can often be saved if it is found that the same factor occurs in both numerator and denominator. These factors cancel each other and can be removed. Example:

$$\frac{2 \times 3 \times 25}{6 \times 5 \times 7} = \frac{5}{7}$$

In the foregoing example it is obvious that the 3 in the numerator goes into the 6 in the denominator twice. We may thus cross out the three and replace the 6 by a 2. The 2 which we have just placed in the denominator cancels the 2 in the numerator. Next the 5 in the denominator will go into the 25 in the numerator leaving a result of 5. Now we have left only a 5 in the numerator and a 7 in the denominator, so our final result is 5/7. If we had multiplied 2 x 3 x 25 to obtain 150 and then had divided this by 6 x 5 x 7 or 210, we would have obtained the same result but, with considerably more work.

Algebra

Algebra is not a separate branch of mathematics but is merely a form of *generalized arithmetic* in which letters of the alphabet and occasional other symbols are substituted for numbers, from which it is often referred to as *literal notation*. It is simply a shorthand method of writing operations which could be spelled out.

The laws of most common electrical phenomena and circuits (including of course radio phenomena and circuits) lend themselves particularly well to representation by literal notation and solution by algebraic equations or formulas.

While we may write a particular problem in Ohm's Law as an ordinary division or multiplication, the general statement of all such problems calls for the replacement of the numbers by symbols. We might be explicit and write out the names of the units and use these names as symbols:

$$\text{volts} = \text{amperes} \times \text{ohms}$$

Such a procedure becomes too clumsy when the expression is more involved and would be unusually cumbersome if any operations like multiplication were required. Therefore as a short way of writing these generalized relations the numbers are represented by letters. Ohm's Law then becomes

$$E = I \times R$$

In the statement of any particular problem the significance of the letters is usually indicated directly below the equation or formula using them unless there can be no ambiguity. Thus the above form of Ohm's Law would be more completely written as:

$$E = I \times R$$

where E = e.m.f. in volts
 I = current in amperes
 R = resistance in ohms

Letters therefore represent numbers, and for any letter we can read "any number." When the same letter occurs again in the same expression we would mentally read "the same number," and for another letter "another number of any value."

These letters are connected by the usual operational symbols of arithmetic, +, -, ×, ÷, and so forth. In algebra, the sign for division is seldom used, a division being usually written as a fraction. The multiplication sign, ×, is usually omitted or one may write a period only. Examples:

$$2 \times a \times b = 2ab$$

$$2.3.4.5a = 2 \times 3 \times 4 \times 5 \times a$$

In practical applications of algebra, an expression usually states some physical law and each letter represents a variable quantity which is therefore called a *variable*. A fixed number in front of such a quantity (by which it is to be multiplied) is known as the *coefficient*. Sometimes the coefficient may be unknown, yet to be determined; it is then also written as a letter; k is most commonly used for this purpose.

The Negative Sign In ordinary arithmetic we seldom work with negative numbers, although we may be "short" in a subtraction. In algebra, however, a number may be either negative or positive. Such a thing may seem *academic* but a negative quantity can have a real existence. We need only refer to a *debt* being considered a negative possession. In electrical work, however, a result of a problem might be a negative number of amperes or volts, indicating that the direction of the current is opposite to the direction chosen as positive. We shall have illustrations of this shortly.

Having established the existence of negative quantities, we must now learn how to work with these negative quantities in addition, subtraction, multiplication and so forth.

In addition, a negative number added to a positive number is the same as subtracting a positive number from it.

$$\frac{7}{-3} \text{ (add) is the same as } \frac{7}{3} \text{ (subtract)}$$

or we might write it

$$7 + (-3) = 7 - 3 = 4$$

Similarly, we have:

$$a + (-b) = a - b$$

When a minus sign is in front of an expression in brackets, this minus sign has the effect of reversing the signs of every term within the brackets:

$$-(a - b) = -a + b$$

$$-(2a + 3b - 5c) = -2a - 3b + 5c$$

Multiplication. When both the multiplicand and the multiplier are negative, the product is positive. When only one (either one) is negative the product is negative. The four possible cases are illustrated below:

$$\begin{array}{ll} + \times + = + & + \times - = - \\ - \times + = - & - \times - = + \end{array}$$

Division. Since division is but the reverse of multiplication, similar rules apply for the sign of the quotient. When both the dividend and the divisor have the same sign (both negative or both positive) the quotient is positive. If they have unlike signs (one positive and one negative) the quotient is negative.

$$\begin{array}{ll} \frac{+}{+} = + & \frac{+}{-} = - \\ \frac{-}{-} = + & \frac{-}{+} = - \\ \frac{-}{+} = - & \frac{+}{-} = - \\ \frac{+}{-} = - & \frac{-}{-} = + \end{array}$$

Powers. Even powers of negative numbers are positive and odd powers are negative. Powers of positive numbers are always positive. Examples:

$$-2^2 = -2 \times -2 = +4$$

$$-2^3 = -2 \times -2 \times -2 = +4 \times -2 = -8$$

Roots. Since the square of a negative number is positive and the square of a positive number is also positive, it follows that a positive number has two square roots. The square root of 4 can be either +2 or -2 for (+2) × (+2) = +4 and (-2) × (-2) = +4.

Addition and Subtraction *Polynomials* are quantities like $3ab^2 + 4ab^3 - 7a^2b^4$ which have several terms of different names. When adding polynomials, only terms of the same name can be taken together.

$$7a^3 + 8ab^2 + 3a^2b \quad + 3$$

$$a^3 - 5ab^2 \quad - b^3$$

$$8a^3 + 3ab^2 + 3a^2b - b^3 + 3$$

Working with Powers and Roots When two powers of the same number are to be multiplied, the exponents are added.

$$a^2 \times a^3 = aa \times aaa = aaaaa = a^5 \text{ or } a^2 \times a^3 = a^{(2+3)} = a^5$$

$$b^3 \times b = b^4$$

$$c^5 \times c^7 = c^{12}$$

Similarly, dividing of powers is done by subtracting the exponents.

$$\frac{a^5}{a^2} = \frac{aaaaa}{aa} = a \text{ or } \frac{a^5}{a^2} = a^{(5-2)} = a^3 = a$$

$$\frac{b^5}{b^2} = \frac{bbbbb}{bb} = b^3 \text{ or } \frac{b^5}{b^2} = b^{(5-2)} = b^3$$

Now we are logically led into some important new ways of notation. We have seen that when dividing, the exponents are subtracted. This can be continued into negative exponents. In the following series, we successively divide by a and since this can now be done in two ways, the two ways of notation must have the same meaning and be identical.

a^5	a^2	$a^{-1} = \frac{1}{a}$
a^4	$a^1 = a$	$a^{-2} = \frac{1}{a^2}$
a^3	$a^0 = 1$	$a^{-3} = \frac{1}{a^3}$

These examples illustrate two rules: (1) any number raised to "zero" power equals one or unity; (2) any quantity raised to a negative power is the inverse or reciprocal of the same quantity raised to the same positive power.

$$n^0 = 1 \quad a^{-n} = \frac{1}{a^n}$$

Roots. The product of the square root of two quantities equals the square root of their product.

$$\sqrt{a} \times \sqrt{b} = \sqrt{ab}$$

Also, the quotient of two roots is equal to the root of the quotient.

$$\frac{\sqrt{a}}{\sqrt{b}} = \sqrt{\frac{a}{b}}$$

Note, however, that in addition or subtraction the square root of the sum or difference is *not* the same as the sum or difference of the square roots.

$$\text{Thus, } \sqrt{9} - \sqrt{4} = 3 - 2 = 1$$

$$\text{but } \sqrt{9 - 4} = \sqrt{5} = 2.2361$$

Likewise $\sqrt{a} + \sqrt{b}$ is not the same as $\sqrt{a + b}$

Roots may be written as fractional powers. Thus \sqrt{a} may be written as $a^{1/2}$ because

$$\sqrt{a} \times \sqrt{a} = a$$

$$\text{and, } a^{1/2} \times a^{1/2} = a^{1/2+1/2} = a^1 = a$$

Any root may be written in this form

$$\sqrt[n]{b} = b^{1/n} \quad \sqrt[3]{b} = b^{1/3} \quad \sqrt[4]{b^3} = b^{3/4}$$

The same notation is also extended in the negative direction:

$$b^{-1/2} = \frac{1}{b^{1/2}} = \frac{1}{\sqrt{b}} \quad c^{-1/3} = \frac{1}{c^{1/3}} = \frac{1}{\sqrt[3]{c}}$$

Following the previous rules that exponents add when powers are multiplied,

$$\sqrt{a} \times \sqrt{a} = \sqrt{a^2}$$

$$\text{but also } a^{1/2} \times a^{1/2} = a^{1/2+1/2} = a^1 = a$$

$$\text{therefore } a^{3/2} = \sqrt{a^3}$$

Powers of powers. When a power is again raised to a power, the exponents are multiplied;

$(a^2)^3 = a^6$	$(b^{-1})^2 = b^{-2}$
$(a^3)^4 = a^{12}$	$(b^{-2})^{-4} = b^8$

This same rule also applies to roots of roots and also powers of roots and roots of powers because a root can always be written as a fractional power.

$$\sqrt[3]{\sqrt{a}} = \sqrt{a} \text{ for } (a^{1/2})^{1/3} = a^{1/6}$$

Removing radicals. A root or radical in the denominator of a fraction makes the expression difficult to handle. If there must be a radical it should be located in the numerator rather than in the denominator. The removal of the radical from the denominator is done by multiplying both numerator and denominator by a quantity which will remove the radical from the denominator, thus *rationalizing* it:

$$\frac{1}{\sqrt{a}} = \frac{\sqrt{a}}{\sqrt{a} \times \sqrt{a}} = \frac{1}{a} \sqrt{a}$$

Suppose we have to rationalize

$\frac{3a}{\sqrt{a} + \sqrt{b}}$ In this case we must multiply numerator and denominator by $\sqrt{a} - \sqrt{b}$, the same terms but with the second having the opposite sign, so that their product will not contain a root.

$$\frac{3a}{\sqrt{a} + \sqrt{b}} = \frac{3a(\sqrt{a} - \sqrt{b})}{(\sqrt{a} + \sqrt{b})(\sqrt{a} - \sqrt{b})} = \frac{3a(\sqrt{a} - \sqrt{b})}{a - b}$$

Imaginary Numbers Since the square of a negative number is positive and the square of a positive number is also positive, the square root of a negative number can be neither positive nor negative. Such a number is said to be *imaginary*; the most common such number ($\sqrt{-1}$) is often represented by the letter *i* in mathematical work or *j* in electrical work.

$$\sqrt{-1} = i \text{ or } j \text{ and } i^2 \text{ or } j^2 = -1$$

Imaginary numbers do not exactly correspond to anything in our experience and it is best not to try to visualize them. Despite this fact, their interest is much more than academic, for they are extremely useful in many calculations involving alternating currents.

The square root of any other negative number may be reduced to a product of two roots, one positive and one negative. For instance:

$$\sqrt{-57} = \sqrt{-1} \sqrt{57} = i\sqrt{57}$$

or, in general

$$\sqrt{-a} = i\sqrt{a}$$

Since $i = \sqrt{-1}$, the powers of *i* have the following values:

$$i^2 = -1$$

$$i^3 = -1 \times i = -i$$

$$i^4 = +1$$

$$i^5 = +1 \times i = i$$

Imaginary numbers are different from either positive or negative numbers; so in addition or subtraction they must always be accounted for separately. Numbers which consist of both real and imaginary parts are called *complex* numbers. Examples of complex numbers:

$$3 + 4i = 3 + 4\sqrt{-1}$$

$$a + bi = a + b\sqrt{-1}$$

Since an imaginary number can never be equal to a real number, it follows that in an equality like

$$a + bi = c + di$$

a must equal *c* and *bi* must equal *di*

Complex numbers are handled in algebra just like any other expression, considering *i* as a known quantity. Whenever powers of *i* occur, they can be replaced by the equivalents given above. This idea of having in one equation two separate sets of quantities which must

be accounted for separately, has found a symbolic application in vector notation. These are covered later in this chapter.

Equations of the First Degree Algebraic expressions usually come in the form of equations, that is, one set of terms equals another set of terms. The simplest example of this is Ohm's Law:

$$E = IR$$

One of the three quantities may be unknown but if the other two are known, the third can be found readily by substituting the known values in the equation. This is very easy if it is *E* in the above example that is to be found; but suppose we wish to find *I* while *E* and *R* are given. We must then rearrange the equation so that *I* comes to stand alone to the left of the equality sign. This is known as *solving the equation for I*.

Solution of the equation in this case is done simply by transposing. If two things are equal then they must still be equal if both are multiplied or divided by the same number. Dividing both sides of the equation by *R*:

$$\frac{E}{R} = \frac{IR}{R} = I \text{ or } I = \frac{E}{R}$$

If it were required to solve the equation for *R*, we should divide both sides of the equation by *I*.

$$\frac{E}{I} = R \text{ or } R = \frac{E}{I}$$

A little more complicated example is the equation for the reactance of a condenser:

$$X = \frac{1}{2\pi fC}$$

To solve this equation for *C*, we may multiply both sides of the equation by *C* and divide both sides by *X*

$$X \times \frac{C}{X} = \frac{1}{2\pi fC} \times \frac{C}{X}, \text{ or}$$

$$C = \frac{1}{2\pi fX}$$

This equation is one of those which requires a good knowledge of the placing of the decimal point when solving. Therefore we give a few examples: What is the reactance of a 25 $\mu\mu\text{fd.}$ capacitor at 1000 kc.? In filling in the given values in the equation we must remember that the units used are farads, cycles, and ohms. Hence, we must write 25 $\mu\mu\text{fd.}$ as 25 millionths of a millionth of a farad or 25×10^{-12} farad; similarly, 1000 kc. must be converted to 1,000,000 cycles. Substituting these values in the original equation, we have

$$X = \frac{1}{2 \times 3.14 \times 1,000,000 \times 25 \times 10^{-12}}$$

$$X = \frac{1}{6.28 \times 10^6 \times 25 \times 10^{-12}} = \frac{10^6}{6.28 \times 25} = 6360 \text{ ohms}$$

A bias resistor of 1000 ohms should be bypassed, so that at the lowest frequency the reactance of the condenser is 1/10th of that of the resistor. Assume the lowest frequency to be 50 cycles, then the required capacity should have a reactance of 100 ohms, at 50 cycles:

$$C = \frac{1}{2 \times 3.14 \times 50 \times 100} \text{ farads}$$

$$C = \frac{10^6}{6.28 \times 5000} \text{ microfarads}$$

$$C = 32 \mu\text{fd.}$$

In the third possible case, it may be that the frequency is the unknown. This happens for instance in some tone control problems. Suppose it is required to find the frequency which makes the reactance of a 0.03 $\mu\text{fd.}$ condenser equal to 100,000 ohms.

First we must solve the equation for f . This is done by transposition.

$$X = \frac{1}{2\pi fC} \qquad f = \frac{1}{2\pi CX}$$

Substituting known values

$$f = \frac{1}{2 \times 3.14 \times 0.03 \times 10^{-6} \times 100,000} \text{ cycles}$$

$$f = \frac{1}{0.01884} \text{ cycles} = 53 \text{ cycles}$$

These equations are known as first degree equations with one unknown. First degree, because the unknown occurs only as a first power. Such an equation always has one possible solution or *root* if all the other values are known.

If there are two unknowns, a single equation will not suffice, for there are then an infinite number of possible solutions. In the case of two unknowns we need *two independent* simultaneous equations. An example of this is:

$$3x + 5y = 7 \qquad 4x - 10y = 3$$

Required, to find x and y .

This type of work is done either by the *substitution method* or by the *elimination method*. In the substitution method we might write for the first equation:

$$3x = 7 - 5y \therefore x = \frac{7 - 5y}{3}$$

(The symbol \therefore means *therefore* or *hence*).

This value of x can then be substituted for x in the second equation making it a single equation with but one unknown, y .

It is, however, simpler in this case to use the elimination method. Multiply both sides of the first equation by two and add it to the second equation:

$$\begin{array}{r} 6x + 10y = 14 \\ 4x - 10y = 3 \\ \hline 10x = 17 \end{array} \text{ add} \qquad x = 1.7$$

Substituting this value of x in the first equation, we have

$$5.1 + 5y = 7 \therefore 5y = 7 - 5.1 = 1.9 \therefore y = 0.38$$

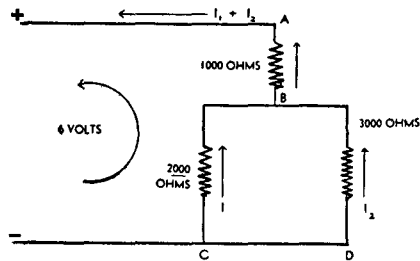

Figure 3.

In this simple network the current divides through the 2000-ohm and 3000-ohm resistors. The current through each may be found by using two simultaneous linear equations. Note that the arrows indicate the direction of electron flow as explained on page 18.

An application of two simultaneous linear equations will now be given. In Figure 3 a simple network is shown consisting of three resistances; let it be required to find the currents I_1 and I_2 in the two branches.

The general way in which all such problems can be solved is to assign directions to the currents through the various resistances. When these are chosen wrong it will do no harm for the result of the equations will then be negative, showing up the error. In this simple illustration there is, of course, no such difficulty.

Next we write the equations for the meshes, in accordance with Kirchhoff's second law. All voltage drops in the direction of the curved arrow are considered positive, the reverse ones negative. Since there are two unknowns we write two equations.

$$\begin{aligned} 1000 (I_1 + I_2) + 2000 I_1 &= 6 \\ -2000 I_1 + 3000 I_2 &= 0 \end{aligned}$$

Expand the first equation

$$3000 I_1 + 1000 I_2 = 6$$

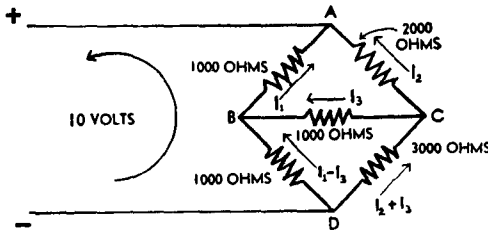

Figure 4.

A MORE COMPLICATED PROBLEM REQUIRING THE SOLUTION OF CURRENTS IN A NETWORK.

This problem is similar to that in Figure 3 but requires the use of three simultaneous linear equations.

Multiply this equation by 3

$$9000 I_1 + 3000 I_2 = 18$$

Subtracting the second equation from the first

$$11000 I_1 = 18$$

$$I_1 = 18/11000 = 0.00164 \text{ amp.}$$

Filling in this value in the second equation

$$3000 I_2 = 3.28 \quad I_2 = 0.00109 \text{ amp.}$$

A similar problem but requiring three equations is shown in Figure 4. This consists of an unbalanced bridge and the problem is to find the current in the bridge-branch, I_3 . We again assign directions to the different currents, guessing at the one marked I_3 . The voltages around closed loops ABC [eq. (1)] and BDC [eq. (2)] equal zero and are assumed to be positive in a counterclockwise direction; that from D to A equals 10 volts [eq. (3)].

$$(1) \quad -1000 I_1 + 2000 I_2 - 1000 I_3 = 0$$

$$(2) \quad -1000 (I_1 - I_3) + 1000 I_2 + 3000 (I_2 + I_3) = 0$$

$$(3) \quad 1000 I_1 + 1000 (I_1 - I_3) - 10 = 0$$

Expand equations (2) and (3)

$$(2) \quad -1000 I_1 + 3000 I_2 + 5000 I_3 = 0$$

$$(3) \quad 2000 I_1 - 1000 I_3 - 10 = 0$$

Subtract equation (2) from equation (1)

$$(a) \quad -1000 I_2 - 6000 I_3 = 10$$

Multiply the second equation by 2 and add it to the third equation

$$(b) \quad 6000 I_2 + 9000 I_3 - 10 = 0$$

Now we have but two equations with two unknowns.

Multiplying equation (a) by 6 and adding to equation (b) we have

$$-27000 I_3 - 10 = 0$$

$$I_3 = -10/27000 = -0.00037 \text{ amp.}$$

Note that now the solution is negative which means that we have drawn the arrow for I_3 in Figure 4 in the wrong direction. The current is 0.37 ma. in the other direction.

Second Degree or Quadratic Equations A somewhat similar problem in radio would be, if power in watts and resistance in ohms of a circuit are given, to find the voltage and the current. Example: When lighted to normal brilliancy, a 100 watt lamp has a resistance of 49 ohms; for what line voltage was the lamp designed and what current would it take.

Here we have to use the simultaneous equations:

$$P = EI \quad \text{and} \quad E = IR$$

Filling in the known values:

$$P = EI = 100 \quad \text{and} \quad E = IR = I \times 49$$

Substitute the second equation into the first equation

$$P = EI = (I) \times I \times 49 = 49 I^2 = 100$$

$$\therefore I = \sqrt{\frac{100}{49}} = \frac{10}{7} = 1.43 \text{ amp.}$$

Substituting the found value of 1.43 amp. for I in the first equation, we obtain the value of the line voltage, 70 volts.

Note that this is a *second degree* equation for we finally had the second power of I . Also, since the current in this problem could only be positive, the negative square root of 100/49 or $-10/7$ was not used. Strictly speaking, however, there are two more values that satisfy both equations, these are -1.43 and -70 .

In general, a second degree equation in one unknown has two roots, a third degree equation three roots, etc.

The Quadratic Equation Quadratic or second degree equations with but one unknown can be reduced to the general form

$$ax^2 + bx + c = 0$$

where x is the unknown and a , b , and c are constants.

This type of equation can sometimes be solved by the method of factoring a three-term expression as follows:

$$2x^2 + 7x + 6 = 0$$

$$2x^2 + 4x + 3x + 6 = 0$$

factoring:

$$2x(x + 2) + 3(x + 2) = 0$$

$$(2x + 3)(x + 2) = 0$$

There are two possibilities when a product is zero. Either the one or the other factor equals zero. Therefore there are two solutions.

$$2x_1 + 3 = 0 \qquad x_1 + 2 = 0$$

$$2x_1 = -3 \qquad x_1 = -2$$

$$x_1 = -1\frac{1}{2}$$

Since factoring is not always easy, the following general solution can usually be employed; in this equation a , b , and c are the coefficients referred to above.

$$x = \frac{-b \pm \sqrt{b^2 - 4ac}}{2a}$$

Applying this method of solution to the previous example:

$$x = \frac{-7 \pm \sqrt{49 - 8 \times 6}}{4} = \frac{-7 \pm \sqrt{1}}{4} = \frac{-7 \pm 1}{4}$$

$$x_1 = \frac{-7 + 1}{4} = -1\frac{1}{2}$$

$$x_2 = \frac{-7 - 1}{4} = -2$$

A practical example involving quadratics is the law of impedance in a.c. circuits. However, this is a simple kind of quadratic equation which can be solved readily without the use of the special formula given above.

$$Z = \sqrt{R^2 + (X_L - X_C)^2}$$

This equation can always be solved for R , by squaring both sides of the equation. It should now be understood that squaring both sides of an equation as well as multiplying both sides with a term containing the unknown may add a new root. Since we know here that Z and R are positive, when we square the expression there is no ambiguity.

$$Z^2 = R^2 + (X_L - X_C)^2$$

$$\text{and } R^2 = Z^2 - (X_L - X_C)^2$$

$$\text{or } R = \sqrt{Z^2 - (X_L - X_C)^2}$$

$$\text{Also: } (X_L - X_C)^2 = Z^2 - R^2$$

$$\text{and } \pm (X_L - X_C) = \sqrt{Z^2 - R^2}$$

But here we do not know the sign of the solution unless there are other facts which indicate it. To find either X_L or X_C alone it would have to be known whether the one or the other is the larger.

Logarithms

Definition and Use A logarithm is the power (or exponent) to which we must raise one number to obtain another.

Although the large numbers used in logarithmic work may make them seem difficult or complicated, in reality the principal use of logarithms is to *simplify* calculations which would otherwise be extremely laborious.

We have seen so far that every operation in arithmetic can be reversed. If we have the addition:

$$a + b = c$$

we can reverse this operation in two ways. It may be that b is the unknown, and then we reverse the equation so that it becomes

$$c - a = b$$

It is also possible that we wish to know a , and that b and c are given. The equation then becomes

$$c - b = a$$

We call both of these reversed operations *subtraction*, and we make no distinction between the two possible reverses.

Multiplication can also be reversed in two manners. In the multiplication

$$ab = c$$

we may wish to know a , when b and c are given, or we may wish to know b when a and c are given. In both cases we speak of *division*, and we make again no distinction between the two.

In the case of powers we can also reverse the operation in two manners, but now they are not equivalent. Suppose we have the equation

$$a^b = c$$

If a is the unknown, and b and c are given, we may reverse the operation by writing

$$\sqrt[b]{c} = a$$

This operation we call *taking the root*. But there is a third possibility: that a and c are given, and that we wish to know b . In other

words, the question is "to which power must we raise a so as to obtain c ?" This operation is known as *taking the logarithm*, and b is the logarithm of c to the base a . We write this operation as follows:

$$\log_a c = b$$

Consider a numerical example. We know $2^3=8$. We can reverse this operation by asking "to which power must we raise 2 so as to obtain 8?" Therefore, the logarithm of 8 to the base 2 is 3, or

$$\log_2 8 = 3$$

Taking any single base, such as 2, we might write a series of all the powers of the base next to the series of their logarithms:

Number:	2	4	8	16	32	64	128	256	512	1024
Logarithm:	1	2	3	4	5	6	7	8	9	10

We can expand this table by finding terms between the terms listed above. For instance, if we let the logarithms increase with $\frac{1}{2}$ each time, successive terms in the upper series would have to be multiplied by the square root of 2. Similarly, if we wish to increase the logarithm by $1/10$ at each term, the ratio between two consecutive terms in the upper series would be the tenth root of 2. Now this short list of numbers constitutes a small logarithm table. It should be clear that one could find the logarithm of any number to the base 2. This logarithm will usually be a number with many decimals.

Logarithmic Bases The fact that we chose 2 as a base for the illustration is purely arbitrary. Any base could be used, and therefore there are many possible systems of logarithms. In practice we use only two bases: The most frequently used base is 10, and the system using this base is known as the system of *common* logarithms, or Briggs' logarithms. The second system employs as a base an odd number, designated by the letter e ; $e = 2.71828$ This is known as the *natural* logarithmic system, also as the Napierian system, and the hyperbolic system. Although different writers may vary on the subject, the usual notation is simply $\log a$ for the common logarithm of a , and $\log_e a$ (or sometimes $\ln a$) for the natural logarithm of a . We shall use the common logarithmic system in most cases, and therefore we shall examine this system more closely.

Common Logarithms In the system wherein 10 is the base, the logarithm of 10 equals 1; the logarithm of 100 equals 2, etc., as shown in the following table:

log	10	=	$\log 10^1 = 1$
log	100	=	$\log 10^2 = 2$
log	1,000	=	$\log 10^3 = 3$
log	10,000	=	$\log 10^4 = 4$
log	100,000	=	$\log 10^5 = 5$
log	1,000,000	=	$\log 10^6 = 6$

This table can be extended for numbers less than 10 when we remember the rules of powers discussed under the subject of algebra. Numbers less than unity, too, can be written as powers of ten.

log 1	=	$\log 10^0 = 0$
log 0.1	=	$\log 10^{-1} = -1$
log 0.01	=	$\log 10^{-2} = -2$
log 0.001	=	$\log 10^{-3} = -3$
log 0.0001	=	$\log 10^{-4} = -4$

From these examples follow several rules: The logarithm of any number between zero and + 1 is negative; the logarithm of zero is minus infinity; the logarithm of a number greater than + 1 is positive. *Negative numbers have no logarithm*. These rules are true of common logarithms and of logarithms to any base.

The logarithm of a number between the powers of ten is an irrational number, that is, it has a never ending series of decimals. For instance, the logarithm of 20 must be between 1 and 2 because 20 is between 10 and 100; the value of the logarithm of 20 is 1.30103. . . . The part of the logarithm to the left of the decimal point is called the *characteristic*, while the decimals are called the *mantissa*. In the case of 1.30103 . . ., the logarithm of 20, the characteristic is 1 and the mantissa is .30103 . . .

Properties of Logarithms If the base of our system is ten, then, by definition of a logarithm:

$$10^{\log a} = a$$

or, if the base is raised to the power having an exponent equal to the logarithm of a number, the result is that number.

The logarithm of a *product* is equal to the *sum* of the logarithms of the two factors.

$$\log ab = \log a + \log b$$

This is easily proved to be true because, if

Figure 5. FOUR PLACE LOGARITHM TABLES.

N	0	1	2	3	4	5	6	7	8	9
10	0000	0043	0086	0128	0170	0212	0253	0294	0334	0374
11	0414	0453	0492	0531	0569	0607	0645	0682	0719	0755
12	0792	0828	0864	0899	0934	0969	1004	1038	1072	1106
13	1139	1173	1206	1239	1271	1303	1335	1367	1399	1430
14	1461	1492	1523	1553	1584	1614	1644	1673	1703	1732
15	1761	1790	1818	1847	1875	1903	1931	1959	1987	2014
16	2041	2068	2095	2122	2148	2175	2201	2227	2253	2279
17	2304	2330	2355	2380	2405	2430	2455	2480	2504	2529
18	2553	2577	2601	2625	2648	2672	2695	2718	2742	2765
19	2788	2810	2833	2856	2878	2900	2923	2945	2967	2989
20	3010	3032	3054	3075	3096	3118	3139	3160	3181	3201
21	3222	3243	3263	3284	3304	3324	3345	3365	3385	3404
22	3424	3444	3464	3483	3502	3522	3541	3560	3579	3598
23	3617	3636	3655	3674	3692	3711	3729	3747	3766	3784
24	3802	3820	3838	3856	3874	3892	3909	3927	3945	3962
25	3979	3997	4014	4031	4048	4065	4082	4099	4116	4133
26	4150	4166	4183	4200	4216	4232	4249	4265	4281	4298
27	4314	4330	4346	4362	4378	4393	4409	4425	4440	4456
28	4472	4487	4502	4518	4533	4548	4564	4579	4594	4609
29	4624	4639	4654	4669	4683	4698	4713	4728	4742	4757
30	4771	4786	4800	4814	4829	4843	4857	4871	4886	4900
31	4914	4928	4942	4955	4969	4983	4997	5011	5024	5038
32	5051	5065	5079	5092	5105	5119	5132	5145	5159	5172
33	5185	5198	5211	5224	5237	5250	5263	5276	5289	5302
34	5315	5328	5340	5353	5366	5378	5391	5403	5416	5428
35	5441	5453	5465	5478	5490	5502	5514	5527	5539	5551
36	5563	5575	5587	5599	5611	5623	5635	5647	5658	5670
37	5682	5694	5705	5717	5729	5740	5752	5763	5775	5786
38	5798	5809	5821	5832	5843	5855	5866	5877	5888	5899
39	5911	5922	5933	5944	5955	5966	5977	5988	5999	6010
40	6021	6031	6042	6053	6064	6075	6085	6096	6107	6117
41	6128	6138	6149	6160	6170	6180	6191	6201	6212	6222
42	6232	6243	6253	6263	6274	6284	6294	6304	6314	6325
43	6335	6345	6355	6365	6375	6385	6395	6405	6415	6425
44	6435	6444	6454	6464	6474	6484	6493	6503	6513	6522
45	6532	6542	6551	6561	6571	6580	6590	6599	6609	6618
46	6628	6637	6646	6656	6665	6675	6684	6693	6702	6712
47	6721	6730	6739	6749	6758	6767	6776	6785	6794	6803
48	6812	6821	6830	6839	6848	6857	6866	6875	6884	6893
49	6902	6911	6920	6928	6937	6946	6955	6964	6972	6981
50	6990	6998	7007	7016	7024	7033	7042	7050	7059	7067
51	7076	7084	7093	7101	7110	7118	7126	7135	7143	7152
52	7160	7168	7177	7185	7193	7202	7210	7218	7226	7235
53	7243	7251	7259	7267	7275	7284	7292	7300	7308	7316
54	7324	7332	7340	7348	7356	7364	7372	7380	7388	7396

N	0	1	2	3	4	5	6	7	8	9
55	7404	7412	7419	7427	7435	7443	7451	7459	7466	7474
56	7482	7490	7497	7505	7513	7520	7528	7536	7543	7551
57	7559	7566	7574	7582	7589	7597	7604	7612	7619	7527
58	7634	7642	7649	7657	7664	7672	7679	7686	7694	7701
59	7709	7716	7723	7731	7738	7745	7752	7760	7767	7774
60	7782	7789	7796	7803	7810	7818	7825	7832	7839	7846
61	7853	7860	7868	7875	7882	7889	7896	7903	7910	7917
62	7924	7931	7938	7945	7952	7959	7966	7973	7980	7987
63	7993	8000	8007	8014	8021	8028	8035	8041	8048	8055
64	8062	8069	8075	8082	8089	8096	8102	8109	8116	8122
65	8129	8136	8142	8149	8156	8162	8169	8176	8182	8189
66	8195	8202	8209	8215	8222	8228	8235	8241	8248	8254
67	8261	8267	8274	8280	8287	8293	8299	8306	8312	8319
68	8325	8331	8338	8344	8351	8357	8363	8370	8376	8382
69	8388	8395	8401	8407	8414	8420	8426	8432	8439	8445
70	8451	8457	8463	8470	8476	8482	8488	8494	8500	8506
71	8513	8519	8525	8531	8537	8543	8549	8555	8561	8567
72	8573	8579	8585	8591	8597	8603	8609	8615	8621	8627
73	8633	8639	8645	8651	8657	8663	8669	8675	8681	8686
74	8692	8698	8704	8710	8716	8722	8727	8733	8739	8745
75	8751	8756	8762	8768	8774	8779	8785	8791	8797	8802
76	8808	8814	8820	8825	8831	8837	8842	8848	8854	8859
77	8865	8871	8876	8882	8887	8893	8899	8904	8910	8915
78	8921	8927	8932	8938	8943	8949	8954	8960	8965	8971
79	8976	8982	8987	8993	8998	9004	9009	9015	9020	9025
80	9031	9036	9042	9047	9053	9058	9063	9069	9074	9079
81	9085	9090	9096	9101	9106	9112	9117	9122	9128	9133
82	9138	9143	9149	9154	9159	9165	9170	9175	9180	9186
83	9191	9196	9201	9206	9212	9217	9222	9227	9232	9238
84	9243	9248	9253	9258	9263	9269	9274	9279	9284	9289
85	9294	9299	9304	9309	9315	9320	9325	9330	9335	9340
86	9345	9350	9355	9360	9365	9370	9375	9380	9385	9390
87	9395	9400	9405	9410	9415	9420	9425	9430	9435	9440
88	9445	9450	9455	9460	9465	9469	9474	9479	9484	9489
89	9494	9499	9504	9509	9513	9518	9523	9528	9533	9538
90	9542	9547	9552	9557	9562	9566	9571	9576	9581	9586
91	9590	9595	9600	9605	9609	9614	9619	9624	9628	9633
92	9638	9643	9647	9652	9657	9661	9666	9671	9675	9680
93	9685	9689	9694	9699	9703	9708	9713	9717	9722	9727
94	9731	9736	9741	9745	9750	9754	9759	9763	9768	9773
95	9777	9782	9786	9791	9795	9800	9805	9809	9814	9818
96	9823	9827	9832	9836	9841	9845	9850	9854	9859	9863
97	9868	9872	9877	9881	9886	9890	9894	9899	9903	9908
98	9912	9917	9921	9926	9930	9934	9939	9943	9948	9952
99	9956	9961	9965	9969	9974	9978	9983	9987	9991	9996

was shown before that when multiplying to powers, the exponents are added; therefore,

$$a \times b = 10^{\log a} \times 10^{\log b} = 10^{(\log a + \log b)}$$

Similarly, the logarithm of a quotient is the difference between the logarithm of the dividend and the logarithm of the divisor.

$$\log \frac{a}{b} = \log a - \log b$$

This is so because by the same rules of exponents:

$$\frac{a}{b} = \frac{10^{\log a}}{10^{\log b}} = 10^{(\log a - \log b)}$$

We have thus established an easier way of multiplication and division since these operations have been reduced to adding and subtracting.

The logarithm of a power of a number is equal to the logarithm of that number, multiplied by the exponent of the power.

$$\log a^2 = 2 \log a \text{ and } \log a^3 = 3 \log a$$

or, in general:

$$\log a^n = n \log a$$

Also, the logarithm of a root of a number is equal to the logarithm of that number divided by the index of the root:

$$\log \sqrt[n]{a} = \frac{1}{n} \log a$$

It follows from the rules of multiplication, that numbers having the same digits but different locations for the decimal point, have logarithms with the same mantissa:

$$\log 829 = 2.918555$$

$$\log 82.9 = 1.918555$$

$$\log 8.29 = 0.918555$$

$$\log 0.829 = -1.918555$$

$$\log 0.0829 = -2.918555$$

$$\log 829 = \log (8.29 \times 100) = \log 8.29 + \log 100 = 0.918555 + 2$$

Logarithm tables give the mantissas of logarithms only. The characteristic has to be determined by inspection. The characteristic is equal to the number of digits to the left of the decimal point *minus one*. In the case of logarithms of numbers less than unity, the characteristic is negative and is equal to the number of ciphers to the right of the decimal point *plus one*.

For reasons of convenience in making up

logarithm tables, it has become the rule that the mantissa should always be positive. Such notations above as -1.918555 really mean $(+0.918555 - 1)$ and -2.981555 means $(+0.918555 - 2)$. There are also some other notations in use such as

$$\bar{1}.918555 \text{ and } \bar{2}.918555$$

$$\text{also } 9.918555 - 10 \quad 8.918555 - 10 \\ 7.918555 - 10, \text{ etc.}$$

When, after some addition and subtraction of logarithms a mantissa should come out negative, one cannot look up its equivalent number or *anti-logarithm* in the table. The mantissa must first be made positive by adding and subtracting an appropriate integral number. Example: Suppose we find that the logarithm of a number is -0.34569 , then we can transform it into the proper form by adding and subtracting 1

$$\begin{array}{r} 1 \\ -0.34569 \\ \hline 0.65431 - 1 \text{ or } -1.65431 \end{array}$$

Using Logarithm Tables

Logarithms are used for calculations involving multiplication, division, powers, and roots. Especially when the numbers are large and for higher, or fractional powers and roots, this becomes the most convenient way.

Logarithm tables are available giving the logarithms to three places, some to four places, others to five and six places. The table to use depends on the accuracy required in the result of our calculations. The four place table, printed in this chapter, permits the finding of answers to problems to four significant figures which is good enough for most constructional purposes. If greater accuracy is required a five place table should be consulted. The five place table is perhaps the most popular of all.

Referring now to the four place table, to find a common logarithm of a number, proceed as follows. Suppose the number is 5576. First, determine the characteristic. An inspection will show that the characteristic should be 3. This figure is placed to the left of the decimal point. The mantissa is now found by reference to the logarithm table. The first two numbers are 55; glance down the *N* column until coming to these figures. Advance to the right until coming in line with the column headed 7; the mantissa will be 7459. (Note that the column headed 7 corresponds to the *third figure* in the number 5576.) Place the mantissa 7459 to the right of the decimal point, making the logarithm of 5576 now read 3.7459. *Important:* do not consider the last figure 6 in the

N	L	0*	1	2	3	4	5	6	7	8	9	P.P.
250	39	794	811	829	846	863	881	898	915	933	950	
251		967	985	*002	*019	*037	*054	*071	*088	*106	*123	18
252	40	140	157	175	192	209	226	243	261	278	295	1 1.8
253		312	329	346	364	381	398	415	432	449	466	2 3.6
254		483	500	518	535	552	569	586	603	620	637	3 5.4
												4 7.2
255		654	671	688	705	722	739	756	773	790	807	etc.

Figure 6.

A SMALL SECTION OF A FIVE PLACE LOGARITHM TABLE.

Logarithms may be found with greater accuracy with such tables, but they are only of use when the accuracy of the original data warrants greater precision in the figure work. Slightly greater accuracy may be obtained for intermediate points by interpolation, as explained in the text.

number 5576 when looking for the mantissa in the accompanying four place tables; in fact, one may usually disregard all digits beyond the first three when determining the mantissa. (*Interpolation*, sometimes used to find a logarithm more accurately, is unnecessary unless warranted by unusual accuracy in the available data.) However, be doubly sure to include all figures when ascertaining the magnitude of the characteristic.

To find the anti-logarithm, the table is used in reverse. As an example, let us find the anti-logarithm of 1.272 or, in other words, find the number of which 1.272 is the logarithm. Look in the table for the mantissa closest to 272. This is found in the first half of the table and the nearest value is 2718. Write down the first two significant figures of the anti-logarithm by taking the figures at the beginning of the line on which 2718 was found. This is 18; add to this, the digit above the column in which 2718 was found; this is 7. The anti-logarithm is 187 but we have not yet placed the decimal point. The characteristic is 1, which means that there should be two digits to the left of the decimal point. Hence, 18.7 is the anti-logarithm of 1.272.

For the sake of completeness we shall also describe the same operation with a five-place table where interpolation is done by means of tables of proportional parts (P.P. tables). Therefore we are reproducing here a small part of one page of a five-place table.

Finding the logarithm of 0.025013 is done as follows: We can begin with the characteristic, which is -2 . Next find the first three digits in the column, headed by *N* and immediately after this we see 39, the first two digits of the mantissa. Then look among the headings of the other columns for the next digit of the number, in this case 1. In the column, headed by 1 and on the line headed 250, we find the next three digits of the logarithm, 811. So far,

the logarithm is -2.39811 but this is the logarithm of 0.025010 and we want the logarithm of 0.025013. Here we can interpolate by observing that the difference between the log of 0.02501 and 0.02502 is $829 - 811$ or 18, in the last two significant figures. Looking in the P.P. table marked 18 we find after 3 the number 5.4 which is to be added to the logarithm.

-2.39811

5.4

-2.39816 , the logarithm of 0.025013

Since our table is only good to five places, we must eliminate the last figure given in the P.P. table if it is less than 5, otherwise we must add one to the next to the last figure, rounding off to a whole number in the P.P. table.

Finding the anti-logarithm is done the same way but with the procedure reversed. Suppose it is required to find the anti-logarithm of 0.40100. Find the first two digits in the column headed by *L*. Then one must look for the next three digits or the ones nearest to it, in the columns after 40 and on the lines from 40 to 41. Now here we find that numbers in the neighborhood of 100 occur only with an asterisk on the line just before 40 and still after 39. The asterisk means that instead of the 39 as the first two digits, these mantissas should have 40 as the first two digits. The logarithm 0.40100 is between the logs 0.40088 and 0.40106; the anti-logarithm is between 2517 and 2518. The difference between the two logarithms in the table is again 18 in the last two figures and our logarithm 0.40100 differs with the lower one 12 in the last figures. Look in the P.P. table of 18 which number comes closest to 12. This is found to be 12.6 for $7 \times 1.8 = 12.6$. Therefore we may add the digit 7 to the anti-logarithm already found; so we have 25177. Next, place the decimal point according to the rules: There are as many digits to the left of the decimal point as indicated in the characteristic plus one. The anti-logarithm of 0.40100 is 2.5177.

In the following examples of the use of logarithms we shall use only three places from the tables printed in this chapter since a greater degree of precision in our calculations would not be warranted by the accuracy of the data given.

In a 375 ohm bias resistor flows a current of 41.5 milliamperes; how many watts are dissipated by the resistor?

We write the equation for power in watts:

$$P = I^2R$$

and filling in the quantities in question, we have:

$$P = 0.0415^2 \times 375$$

Taking logarithms,

$$\log P = 2 \log 0.0415 + \log 375$$

$$\log 0.0415 = -2.618$$

$$\text{So } 2 \times \log 0.0415 = -3.236$$

$$\log 375 = 2.574$$

$$\log P = -1.810$$

$$\text{antilog} = 0.646. \text{ Answer} = 0.646 \text{ watts}$$

Caution: Do not forget that the negative sign before the characteristic belongs to the characteristic only and that mantissas are *always* positive. Therefore we recommend the other notation, for it is less likely to lead to errors. The work is then written:

$$\begin{aligned} \log 0.0415 &= 8.618 - 10 \\ 2 \times \log 0.0415 &= 17.236 - 20 = 7.236 - 10 \\ \log 375 &= 2.574 \\ \log P &= 9.810 - 10 \end{aligned}$$

Another example follows which demonstrates the ease in handling powers and roots. Assume an all-wave receiver is to be built, covering from 550 kc. to 60 mc. Can this be done in five ranges and what will be the required tuning ratio for each range if no overlapping is required? Call the tuning ratio of one band, x . Then the total tuning ratio for five such bands is x^5 . But the total tuning ratio for all bands is 60/0.55. Therefore:

$$x^5 = \frac{60}{0.55} \text{ or } x = \sqrt[5]{\frac{60}{0.55}}$$

Taking logarithms:

$$\begin{aligned} \log x &= \frac{\log 60 - \log 0.55}{5} \\ \log 60 & 1.778 \\ \log 0.55 & -1.740 \\ \hline & 2.038 \text{ subtract} \end{aligned}$$

Remember again that the mantissas are positive and the characteristic alone can be negative. Subtracting -1 is the same as adding $+1$.

$$\begin{aligned} \log x &= \frac{2.038}{5} = 0.408 \\ x &= \text{antilog } 0.408 = 2.56 \end{aligned}$$

The tuning ratio should be 2.56.

db	Power Ratio
0	1.00
1	1.26
2	1.58
3	2.00
4	2.51
5	3.16
6	3.98
7	5.01
8	6.31
9	7.94
10	10.00
20	100
30	1,000
40	10,000
50	100,000
60	1,000,000
70	10,000,000
80	100,000,000

Figure 7.
A TABLE OF DECIBEL GAINS VERSUS POWER RATIOS.

The Decibel

The decibel is a unit for the comparison of power or voltage levels in sound and electrical work. The sensation of our ears due to sound waves in the surrounding air is roughly proportional to the logarithm of the energy of the sound-wave and not proportional to the energy itself. For this reason a logarithmic unit is used so as to approach the reaction of the ear.

The decibel represents a *ratio* of two power levels, usually connected with gains or loss due to an amplifier or other network. The decibel is defined

$$N_{db} = 10 \log \frac{P_o}{P_i}$$

where P_o stands for the output power, P_i for the input power and N_{db} for the number of decibels. When the answer is positive, there is a gain; when the answer is negative, there is a loss.

The gain of amplifiers is usually given in decibels. For this purpose both the input power and output power should be measured. Example: Suppose that an intermediate amplifier is being driven by an input power of 0.2 watt and after amplification, the output is found to be 6 watts.

$$\begin{aligned} \frac{P_o}{P_i} &= \frac{6}{0.2} = 30 \\ \log 30 &= 1.48 \end{aligned}$$

Therefore the gain is $10 \times 1.48 = 14.8$ decibels. The decibel is a logarithmic unit; when the power was multiplied by 30, the power level in decibels was increased-by 14.8 decibels, or 14.8 decibels *added*.

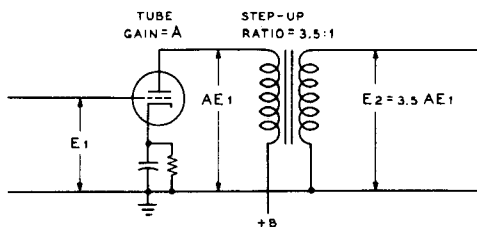

Figure 8.
STAGE GAIN.

The voltage gain in decibels in this stage is equal to the amplification in the tube plus the step-up ratio of the transformer, both expressed in decibels.

When one amplifier is to be followed by another amplifier, power gains are multiplied but the decibel gains are added. If a main amplifier having a gain of 1,000,000 (power ratio is 1,000,000) is preceded by a pre-amplifier with a gain of 1000, the total gain is 1,000,000,000. But in decibels, the first amplifier has a gain of 60 decibels, the second a gain of 30 decibels and the two of them will have a gain of 90 decibels when connected in cascade. (This is true only if the two amplifiers are properly matched at the junction as otherwise there will be a reflection loss at this point which must be subtracted from the total.)

Conversion of power ratios to decibels or vice versa is easy with the small table shown on these pages. In any case, an ordinary logarithm table will do. Find the logarithm of the power ratio and multiply by ten to find decibels.

Sometimes it is more convenient to figure decibels from voltage or current ratios or gains rather than from power ratios. This applies especially to voltage amplifiers. The equation for this is

$$N_{ab} = 20 \log \frac{E_o}{E_i} \text{ or } 20 \log \frac{I_o}{I_i}$$

where the subscript, o , denotes the output voltage or current and i the input voltage or current. Remember, this equation is true only if the voltage or current gain in question represents a power gain which is the square of it and not if the power gain which results from this is some other quantity due to impedance changes. This should be quite clear when we consider that a matching transformer to connect a speaker to a line or output tube does not represent a gain or loss; there is a voltage change and a current change yet the power remains the same for the impedance has changed.

On the other hand, when dealing with voltage amplifiers, we can figure the gain in a stage by finding the voltage ratio from the grid of the first tube to the grid of the next tube.

Example: In the circuit of Figure 8, the gain in the stage is equal to the amplification in the tube and the step-up ratio of the transformer. If the amplification in the tube is 10 and the step-up in the transformer is 3.5, the voltage gain is 35 and the gain in decibels is:

$$20 \times \log 35 = 20 \times 1.54 = 30.8 \text{ db}$$

Decibels as Power Level The original use of the decibel was only as a ratio of power levels—not as an absolute measure of power. However, one may use the decibel as such an absolute unit by fixing an arbitrary “zero” level, and to indicate any power level by its number of decibels above or below this arbitrary zero level. This is all very good so long as we agree on the zero level.

Any power level may then be converted to decibels by the equation:

$$N_{ab} = 10 \log \frac{P_o}{P_{ref.}}$$

where N_{ab} is the desired power level in decibels, P_o the output of the amplifier, $P_{ref.}$ the arbitrary reference level.

The zero level most frequently used (but not always) is 6 milliwatts or 0.006 watts. For this zero level, the equation reduces to

$$N_{ab} = 10 \log \frac{P_o}{0.006}$$

Example: An amplifier using a 6F6 tube should be able to deliver an undistorted output of 3 watts. How much is this in decibels?

$$\frac{P_o}{P_{ref.}} = \frac{3}{.006} = 500$$

$$10 \times \log 500 = 10 \times 2.70 = 27.0$$

Therefore the power level at the output of the 6F6 is 27.0 decibels. When the power level to be converted is less than 6 milliwatts, the level is noted as negative. Here we must remember all that has been said regarding logarithms of numbers less than unity and the fact that the characteristic is negative but not the mantissa.

A preamplifier for a microphone is feeding 1.5 milliwatts into the line going to the regular speech amplifier. What is this power level expressed in decibels?

$$\text{decibels} = 10 \log \frac{P_o}{0.006} =$$

$$10 \log \frac{0.0015}{0.006} = 10 \log 0.25$$

Log 0.25 = -1.398 (from table). Therefore, $10 \times -1.398 = (10 \times -1 = -10) + (10 \times .398 = 3.98)$; adding the products algebraically, gives -6.02 db.

The conversion chart reproduced in this chapter will be of use in converting decibels to watts and vice versa.

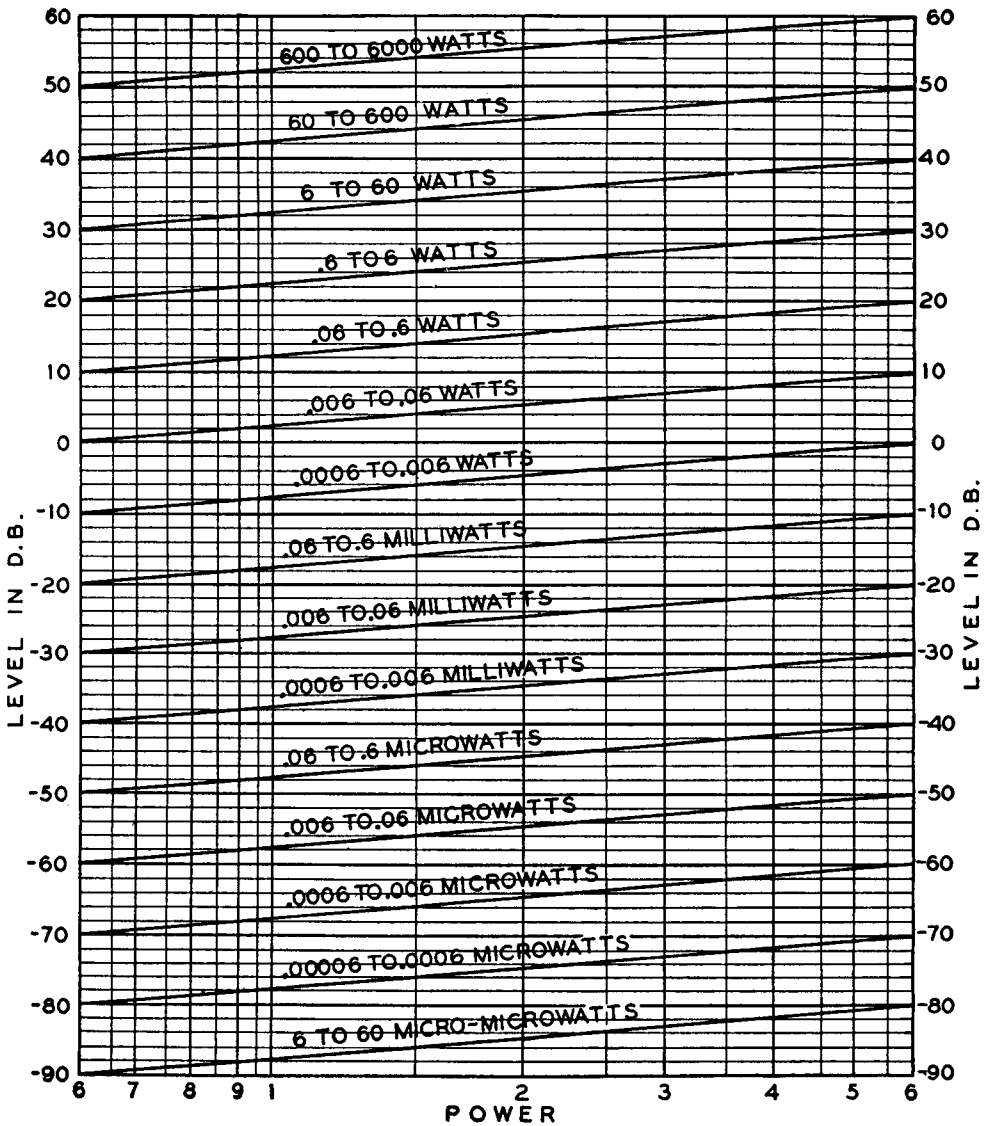

Figure 9.

CONVERSION CHART: POWER TO DECIBELS

Power levels between 6 micromicrowatts and 6000 watts may be referred to corresponding decibel levels between -90 and 60 db, and vice versa, by means of the above chart. Fifteen ranges are provided. Each curve begins at the same point where the preceding one ends, enabling uninterrupted coverage of the wide db and power ranges with condensed chart. For example: the lowermost curve ends at -80 db or 60 micromicrowatts and the next range starts at the same level. Zero db level is taken as 6 milliwatts (.006 watt).

Converting Decibels to Power It is often convenient to be able to convert a decibel value to a power equivalent. The formula used for this operation is

$$P = 0.006 \times \text{antilog} \frac{N_{db}}{10}$$

where P is the desired level in watts and N_{db} the decibels to be converted.

To determine the power level P from a decibel equivalent, simply divide the decibel value by 10; then take the number comprising the antilog and multiply it by 0.006; the product gives the level in watts.

Note: In problems dealing with the conversion of *minus* decibels to power, it often happens that the decibel value $-N_{db}$ is not divisible by 10. When this is the case, the numerator in the factor $-\frac{N_{db}}{10}$ must be made evenly divisible by 10, the negative signs must be observed, and the quotient labeled accordingly.

To make the numerator evenly divisible by 10 proceed as follows: Assume, for example, that $-N_{db}$ is some such value as -38 ; to make this figure evenly divisible by 10, we must add -2 to it, and, since we have added a negative 2 to it, we must also add a positive 2 so as to keep the net result the same.

Our decibel value now stands, $-40 + 2$. Dividing both of these figures by 10, as in the equation above, we have -4 and $+0.2$. Putting the two together we have the logarithm -4.2 with the negative characteristic and the positive mantissa as required.

The following examples will show the technique to be followed in practical problems.

(a) The output of a certain device is rated at -74 db. What is the power equivalent? Solution:

$$\frac{N_{db}}{10} = \frac{-74}{10} \text{ (not evenly divisible by 10)}$$

Routine:

$$\begin{array}{r} -74 \\ -6 \quad +6 \\ \hline -80 \quad +6 \end{array}$$

$$\frac{N_{db}}{10} = \frac{-80 + 6}{10} = -8.6$$

$$\text{antilog } -8.6 = 0.000\ 000\ 04$$

$$\begin{aligned} .006 \times 0.000\ 000\ 04 &= \\ 0.000\ 000\ 000\ 24 \text{ watt or} \\ 240 \text{ micro-microwatt} \end{aligned}$$

(b) This example differs somewhat from that of the foregoing one in that the mantissas are added differently. A low-powered amplifier has an input signal level of -17.3 db. How many milliwatts does this value represent?

Solution:

$$\begin{array}{r} -17.3 \\ -2.7 \quad +2.7 \\ \hline -20 \quad +2.7 \end{array}$$

$$\frac{N_{db}}{10} = \frac{-20 + 2.7}{10} = -2.27$$

$$\text{Antilog } -2.27 = 0.0186$$

$$\begin{aligned} 0.006 \times 0.0186 &= 0.000\ 1116 \text{ watt or} \\ &0.1116 \text{ milliwatt} \end{aligned}$$

Input voltages: To determine the required input voltage, take the peak voltage necessary to drive the last class A amplifier tube to maximum output, and divide this figure by the total overall voltage gain of the preceding stages.

Computing Specifications: From the preceding explanations the following data can be computed with any degree of accuracy warranted by the circumstances:

- (1) Voltage amplification
- (2) Overall gain in db
- (3) Output signal level in db
- (4) Input signal level in db
- (5) Input signal level in watts
- (6) Input signal voltage

When a power level is available which must be brought up to a new power level, the gain required in the intervening amplifier is equal to the difference between the two levels in decibels. If the required input of an amplifier for full output is -30 decibels and the output from a device to be used is but -45 decibels, the pre-amplifier required should have a gain of the difference, or 15 decibels. Again this is true only if the two amplifiers are properly matched and no losses are introduced due to mismatching.

Push-Pull Amplifiers To double the output of any cascade amplifier, it is only necessary to connect in push-pull the last amplifying stage, and replace the inter-stage and output transformers with push-pull types.

To determine the voltage gain (voltage ratio) of a push-pull amplifier, take the ratio of one *half* of the secondary winding of the push-pull transformer and multiply it by the μ of one of the output tubes in the push-pull stage; the product, *when doubled*, will be the voltage amplification, or step-up.

Other Units and Zero Levels When working with decibels one should not immediately take for granted that the zero level is 6 milliwatts for there are other zero levels in use.

In broadcast stations an entirely new system is now employed. Measurements made in

acoustics are now made with the standard zero level of 10^{-16} watts per square cm.

Microphones are often rated with reference to the following zero level: *one volt at open circuit when the sound pressure is one millibar.* In any case, the rating of the microphone must include the loudness of the sound. It is obvious that this zero level does not lend itself readily for the calculation of required gain in an amplifier.

The VU: So far, the decibel has always referred to a type of signal which can readily be measured, that is, a steady signal of a single frequency. But what would be the power level of a signal which is constantly varying in volume and frequency? The measurement of voltage would depend on the type of instrument employed, whether it is measured with a thermal square law meter or one that shows average values; also, the inertia of the movement will change its indications at the peaks and valleys.

After considerable consultation, the broadcast chains and the Bell System have agreed on the *VU*. The level in *VU* is the level in decibels above 1 milliwatt zero level and measured with a carefully defined type of instrument across a 600 ohm line. So long as we deal with an unvarying sound, the level in *VU* is equal to decibels above 1 milliwatt; but when the sound level varies, the unit is the *VU* and the special meter must be used. There is then no equivalent in decibels.

The Neper: We might have used the natural logarithm instead of the common logarithm when defining our logarithmic unit of sound. This was done in Europe and the unit obtained is known as the *neper* or *napier*. It is still found in some American literature on filters.

- 1 neper = 8.686 decibels
- 1 decibel = 0.1151 neper

AC Meters With Decibel Scales Many test instruments are now equipped with scales calibrated in decibels which is very handy when making measurements of frequency characteristics and gain. These meters are generally calibrated for connection across a 500 ohm line and for a zero level of 6 milliwatts. When they are connected across another impedance, the reading on the meter is no longer correct for the zero level of 6 milliwatts. A correction factor should be applied consisting in the addition or subtraction of a steady figure to all readings on the meter. This figure is given by the equation:

$$db \text{ to be added} = 10 \log \frac{500}{Z}$$

where *Z* is the impedance of the circuit under measurement.

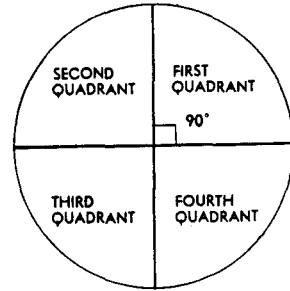

Figure 10.

THE CIRCLE IS DIVIDED INTO FOUR QUADRANTS BY TWO PERPENDICULAR LINES AT RIGHT ANGLES TO EACH OTHER.

The "northeast" quadrant thus formed is known as the first quadrant; the others are numbered consecutively in a counterclockwise direction.

Trigonometry

Definition and Use Trigonometry is the science of mensuration of *triangles*. At first glance triangles may seem to have little to do with electrical phenomena; however, in a.c. work most currents and voltages follow laws equivalent to those of the various trigonometric relations which we are about to examine briefly. Examples of their application to a.c. work will be given in the section on *Vectors*.

Angles are measured in *degrees* or in *radians*. The circle has been divided into 360 degrees, each degree into 60 minutes, and each minute into 60 seconds. A decimal division of the degree is also in use because it makes calculation easier. Degrees, minutes and seconds are indicated by the following signs: °, ' and ". Example: 6° 5' 23" means six degrees, five minutes, twenty-three seconds. In the decimal notation we simply write 8.47°, eight and forty-seven hundredths of a degree.

When a circle is divided into four quadrants by two perpendicular lines passing through the center (Figure 10) the angle made by the two lines is 90 degrees, known as a *right angle*. Two right angles, or 180° equals a *straight angle*.

The radian: If we take the radius of a circle and bend it so it can cover a part of the circumference, the arc it covers subtends an angle called a *radian* (Figure 11). Since the circumference of a circle equals 2 times the radius, there are 2π radians in 360°. So we have the following relations:

- 1 radian = 57° 17' 45" = 57.2958° π = 3.14159
- 1 degree = 0.01745 radians
- π radians = 180° π/2 radians = 90°
- π/3 radians = 60°

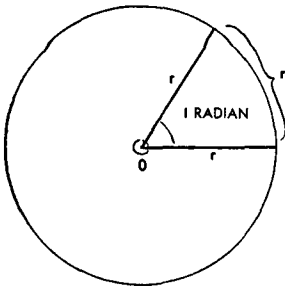

Figure 11.
THE RADIAN.

A radian is an angle whose arc is exactly equal to the length of either side. Note that the angle is constant regardless of the length of the side and the arc so long as they are equal. A radian equals 57.2958°.

In trigonometry we consider an angle generated by two lines, one stationary and the other rotating as if it were hinged at O, Figure 12. Angles can be greater than 180 degrees and even greater than 360 degrees as illustrated in this figure.

Two angles are complements of each other when their sum is 90°, or a right angle. A is the complement of B and B is the complement of A when

$$A = (90^\circ - B)$$

and when

$$B = (90^\circ - A)$$

Two angles are supplements of each other when their sum is equal to a straight angle, or 180°. A is the supplement of B and B is the supplement of A when

$$A = (180^\circ - B)$$

and

$$B = (180^\circ - A)$$

In the angle A, Figure 13A, a line is drawn from P, perpendicular to b. Regardless of the point selected for P, the ratio a/c will always be the same for any given angle, A. So will all the other proportions between a, b, and c remain constant regardless of the position of point P on c. The six possible ratios each are named and defined as follows:

$$\begin{aligned} \text{sine } A &= \frac{a}{c} & \text{cosine } A &= \frac{b}{c} \\ \text{tangent } A &= \frac{a}{b} & \text{cotangent } A &= \frac{b}{a} \\ \text{secant } A &= \frac{c}{b} & \text{cosecant } A &= \frac{c}{a} \end{aligned}$$

Let us take a special angle as an example. For instance, let the angle A be 60 degrees as in Figure 13B. Then the relations between the sides are as in the figure and the six functions become:

$$\begin{aligned} \sin 60^\circ &= \frac{a}{c} = \frac{\frac{1}{2}\sqrt{3}}{1} = \frac{1}{2}\sqrt{3} \\ \cos 60^\circ &= \frac{b}{c} = \frac{\frac{1}{2}}{1} = \frac{1}{2} \\ \tan 60^\circ &= \frac{a}{b} = \frac{\frac{1}{2}\sqrt{3}}{\frac{1}{2}} = \sqrt{3} \\ \cot 60^\circ &= \frac{1/2}{\frac{1}{2}\sqrt{3}} = \frac{1}{\sqrt{3}} = \frac{1}{3}\sqrt{3} \\ \sec 60^\circ &= \frac{c}{b} = \frac{1}{1/2} = 2 \\ \csc 60^\circ &= \frac{c}{a} = \frac{1}{\frac{1}{2}\sqrt{3}} = \frac{2}{3}\sqrt{3} \end{aligned}$$

Another example: Let the angle be 45°, then the relations between the lengths of a, b, and c are as shown in Figure 13C, and the six functions are:

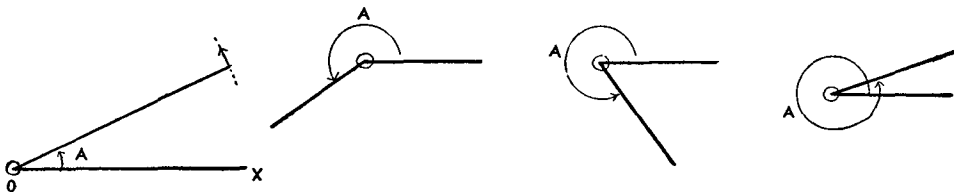

Figure 12.
AN ANGLE IS GENERATED BY TWO LINES, ONE STATIONARY AND THE OTHER ROTATING.

The line OX is stationary; the line with the small arrow at the far end rotates in a counterclockwise direction. At the position illustrated in the lefthandmost section of the drawing it makes an angle, A, which is less than 90° and is therefore in the first quadrant. In the position shown in the second portion of the drawing the angle A has increased to such a value that it now lies in the third quadrant; note that an angle can be greater than 180°. In the third illustration the angle A is in the fourth quadrant. In the fourth position the rotating vector has made more than one complete revolution and is hence in the fifth quadrant; since the fifth quadrant is an exact repetition of the first quadrant, its values will be the same as in the lefthandmost portion of the illustration.

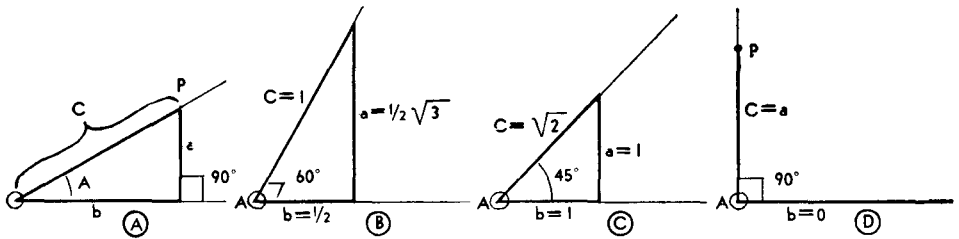

Figure 13.

THE TRIGONOMETRIC FUNCTIONS.

In the right triangle shown in (A) the side opposite the angle A is a, while the adjoining sides are b and c; the trigonometric functions of the angle A are completely defined by the ratios of the sides a, b and c. In (B) are shown the lengths of the sides a and b when angle A is 60° and side c is 1. In (C) angle A is 45°; a and b equal 1, while c equals $\sqrt{2}$. In (D) note that c equals a for a right angle while b equals 0.

$$\sin 45^\circ = \frac{1}{\sqrt{2}} = \frac{1}{2}\sqrt{2}$$

$$\cos 45^\circ = \frac{1}{\sqrt{2}} = \frac{1}{2}\sqrt{2}$$

$$\tan 45^\circ = \frac{1}{1} = 1$$

$$\cot 45^\circ = \frac{1}{1} = 1$$

$$\sec 45^\circ = \frac{\sqrt{2}}{1} = \sqrt{2}$$

$$\operatorname{cosec} 45^\circ = \frac{\sqrt{2}}{1} = \sqrt{2}$$

There are some special difficulties when the angle is zero or 90 degrees. In Figure 13D an angle of 90 degrees is shown; drawing a line perpendicular to b from point P makes it fall on top of c. Therefore in this case a = c and b = 0. The six ratios are now:

$$\sin 90^\circ = \frac{a}{c} = 1 \quad \cos 90^\circ = \frac{b}{c} = \frac{0}{c} = 0$$

$$\tan 90^\circ = \frac{a}{b} = \frac{a}{0} = \infty \quad \cot 90^\circ = \frac{0}{a} = 0$$

$$\sec 90^\circ = \frac{c}{b} = \frac{c}{0} = \infty \quad \operatorname{cosec} 90^\circ = \frac{c}{a} = 1$$

When the angle is zero, a = 0 and b = c. The values are then:

$$\sin 0^\circ = \frac{a}{c} = \frac{0}{c} = 0 \quad \cos 0^\circ = \frac{b}{c} = 1$$

$$\tan 0^\circ = \frac{a}{b} = \frac{0}{b} = 0 \quad \cot 0^\circ = \frac{b}{a} = \frac{b}{0} = \infty$$

$$\sec 0^\circ = \frac{c}{b} = 1 \quad \operatorname{cosec} 0^\circ = \frac{c}{a} = \frac{c}{0} = \infty$$

In general, for every angle, there will be definite values of the six functions. Conversely, when any of the six functions is known, the angle is defined. Tables have been calculated giving the value of the functions for angles.

From the foregoing we can make up a small table of our own (Figure 14), giving values of the functions for some common angles.

Relations Between Functions

It follows from the definitions that

$$\sin A = \frac{1}{\operatorname{cosec} A} \quad \cos A = \frac{1}{\sec A}$$

$$\text{and } \tan A = \frac{1}{\cot A}$$

From the definitions also follows the relation

$$\cos A = \sin(\text{complement of } A) = \sin(90^\circ - A)$$

because in the right triangle of Figure 15, $\cos A = b/c = \sin B$ and $B = 90^\circ - A$ or the complement of A. For the same reason:

$$\cot A = \tan(90^\circ - A)$$

$$\operatorname{csc} A = \sec(90^\circ - A)$$

Relations in Right Triangles

In the right triangle of Figure 15, $\sin A = a/c$ and by transposition

$$a = c \sin A$$

For the same reason we have the following identities:

$$\tan A = a/b \quad a = b \tan A$$

$$\cot A = b/a \quad b = a \cot A$$

In the same triangle we can do the same for functions of the angle B

Angle	Sin	Cos.	Tan	Cot	Sec.	Cosec.
0	0	1	0	∞	1	∞
30°	$\frac{1}{2}$	$\frac{1}{2}\sqrt{3}$	$\frac{1}{3}\sqrt{3}$	$\sqrt{3}$	$\frac{2}{3}\sqrt{3}$	2
45°	$\frac{1}{2}\sqrt{2}$	$\frac{1}{2}\sqrt{2}$	1	1	$\sqrt{2}$	$\sqrt{2}$
60°	$\frac{1}{2}\sqrt{3}$	$\frac{1}{2}$	$\sqrt{3}$	$\frac{1}{3}\sqrt{3}$	2	$\frac{2}{3}\sqrt{3}$
90°	1	0	∞	0	∞	1

Figure 14.

Values of trigonometric functions for common angles in the first quadrant.

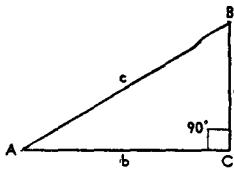

Figure 15.

In this figure the sides *a*, *b*, and *c* are used to define the trigonometric functions of angle *B* as well as angle *A*.

$\sin B = b/c$	$b = c \sin B$
$\cos B = a/c$	$a = c \cos B$
$\tan B = b/a$	$b = a \tan B$
$\cot B = a/b$	$a = b \cot B$

Functions of Angles Greater than 90 Degrees

In angles greater than 90 degrees, the values of *a* and *b* become negative on occasion in accordance with the rules of Cartesian coordinates. When *b* is measured from 0 towards the left it is considered negative and similarly, when *a* is measured from 0 downwards, it is negative. Referring to Figure 16, an angle in the *second quadrant* (between 90° and 180°) has some of its functions negative:

$\sin A = \frac{a}{c} = \text{pos.}$	$\cos A = \frac{-b}{c} = \text{neg.}$
$\tan A = \frac{a}{-b} = \text{neg.}$	$\cot A = \frac{-b}{a} = \text{neg.}$
$\sec A = \frac{c}{-b} = \text{neg.}$	$\text{cosec } A = \frac{c}{a} = \text{pos.}$

For an angle in the third quadrant (180° to 270°), the functions are

$\sin A = \frac{-a}{c} = \text{neg.}$	$\cos A = \frac{-b}{c} = \text{neg.}$
$\tan A = \frac{-a}{-b} = \text{pos.}$	$\cot A = \frac{-b}{-a} = \text{pos.}$

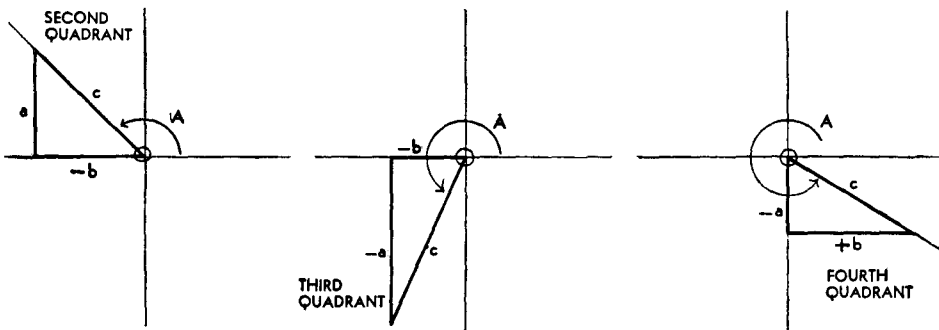

Figure 16.

TRIGONOMETRIC FUNCTIONS IN THE SECOND, THIRD, AND FOURTH QUADRANTS.

The trigonometric functions in these quadrants are similar to first quadrant values, but the signs of the functions vary as listed in the text and in Figure 17.

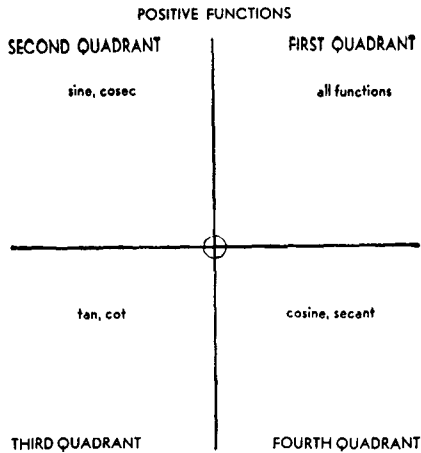

Figure 17.

SIGNS OF THE TRIGONOMETRIC FUNCTIONS.

The functions listed in this diagram are positive; all other functions are negative.

$\sec A = \frac{c}{-b} = \text{neg.}$ $\text{cosec } A = \frac{c}{-a} = \text{neg.}$

And in the fourth quadrant (270° to 360°):

$\sin A = \frac{-a}{c} = \text{neg.}$	$\cos A = \frac{b}{c} = \text{pos.}$
$\tan A = \frac{-a}{b} = \text{neg.}$	$\cot A = \frac{b}{-a} = \text{neg.}$
$\sec A = \frac{c}{b} = \text{pos.}$	$\text{cosec } A = \frac{c}{-a} = \text{neg.}$

Summarizing, the sign of the functions in each quadrant can be seen at a glance from Figure 17, where in each quadrant are written the names of functions which are positive; those not mentioned are negative.

Figure 18.
SINE AND COSINE CURVES.
In (A) we have a sine curve drawn in Cartesian coordinates. This is the usual representation of an alternating current wave without substantial harmonics. In (B) we have a cosine wave; note that it is exactly similar to a sine wave displaced by 90° or $\pi/2$ radians.

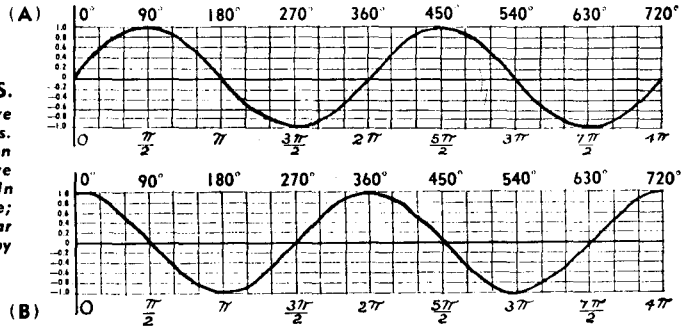

Graphs of Trigonometric Functions

The sine wave. When we have the relation

$$y = \sin x, \text{ where } x \text{ is an}$$

angle measured in radians or degrees, we can draw a curve of y versus x for all values of the independent variable, and thus get a good conception how the sine varies with the magnitude of the angle. This has been done in Figure 18A. We can learn from this curve the following facts.

1. The sine varies between $+1$ and -1
2. It is a periodic curve, repeating itself after every multiple of 2π or 360°
3. $\sin x = \sin (180^\circ - x)$ or $\sin (\pi - x)$
4. $\sin x = -\sin (180^\circ + x)$, or $-\sin (\pi + x)$

The cosine wave. Making a curve for the function $y = \cos x$, we obtain a curve similar to that for $y = \sin x$ except that it is displaced by 90° or $\pi/2$ radians with respect to the Y-axis. This curve (Figure 18B) is also periodic but it does not start with zero. We read from the curve:

1. The value of the cosine never goes beyond $+1$ or -1
2. The curve repeats, after every multiple of 2π radians or 360°

3. $\cos x = -\cos (180^\circ - x)$ or $-\cos (\pi - x)$

4. $\cos x = \cos (360^\circ - x)$ or $\cos (2\pi - x)$

The graph of the tangent is illustrated in Figure 19. This is a discontinuous curve and illustrates well how the tangent increases from zero to infinity when the angle increases from zero to 90° . Then when the angle is further increased, the tangent starts from minus infinity going to zero in the second quadrant, and to infinity again in the third quadrant.

1. The tangent can have any value between $+\infty$ and $-\infty$
2. The curve repeats and the period is π radians or 180° , not 2π radians
3. $\tan x = \tan (180^\circ + x)$ or $\tan (\pi + x)$
4. $\tan x = -\tan (180^\circ - x)$ or $-\tan (\pi - x)$

The graph of the cotangent is the inverse of that of the tangent, see Figure 20. It leads us to the following conclusions:

1. The cotangent can have any value between $+\infty$ and $-\infty$
2. It is a periodic curve, the period being π radians or 180°
3. $\cot x = \cot (180^\circ + x)$ or $\cot (\pi + x)$
4. $\cot x = -\cot (180^\circ - x)$ or $-\cot (\pi - x)$

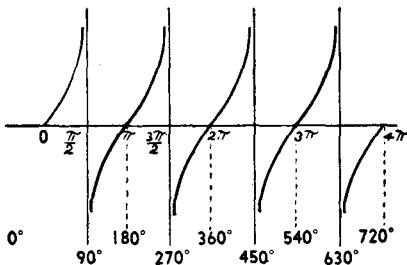

Figure 19.
TANGENT CURVES.

The tangent curve increases from 0 to ∞ with an angular increase of 90° . In the next 180° it increases from $-\infty$ to $+\infty$.

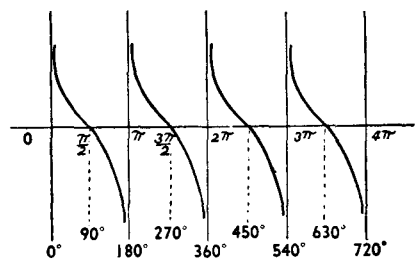

Figure 20.
COTANGENT CURVES.

Cotangent curves are the inverse of the tangent curves. They vary from $+\infty$ to $-\infty$ in each pair of quadrants.

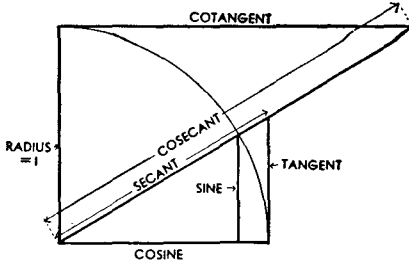

Figure 21.

ANOTHER REPRESENTATION OF TRIGONOMETRIC FUNCTIONS.

If the radius of a circle is considered as the unit of measurement, then the lengths of the various lines shown in this diagram are numerically equal to the functions marked adjacent to them.

The graphs of the secant and cosecant are of lesser importance and will not be shown here. They are the inverse, respectively, of the cosine and the sine, and therefore they vary from +1 to infinity and from -1 to -infinity.

Perhaps another useful way of visualizing the values of the functions is by considering Figure 21. If the radius of the circle is the unit of measurement then the lengths of the lines are equal to the functions marked on them.

Trigonometric Tables There are two kinds of trigonometric tables.

The first type gives the functions of the angles, the second the logarithms of the functions. The first kind is also known as the table of natural trigonometric functions.

These tables give the functions of all angles between 0 and 45°. This is all that is necessary for the function of an angle between 45° and 90° can always be written as the co-function of an angle below 45°. Example: If we had to find the sine of 48°, we might write

$$\sin 48^\circ = \cos (90^\circ - 48^\circ) = \cos 42^\circ$$

Tables of the logarithms of trigonometric functions give the common logarithms (\log_{10}) of these functions. Since many of these logarithms have negative characteristics, one should add -10 to all logarithms in the table which have a characteristic of 6 or higher. For instance, the $\log \sin 24^\circ = 9.60931 - 10$. $\log \tan 1^\circ = 8.24192 - 10$ but $\log \cot 1^\circ = 1.75808$. When the characteristic shown is less than 6, it is supposed to be positive and one should not add -10.

Vectors

A scalar quantity has magnitude only; a vector quantity has both magnitude and direction. When we speak of a speed of 50 miles per hour, we are using a scalar quantity, but when we say the wind is Northeast and has a

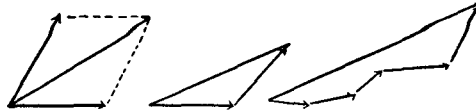

Figure 22.

Vectors may be added as shown in these sketches. In each case the long vector represents the vector sum of the smaller vectors. For many engineering applications sufficient accuracy can be obtained by this method which avoids long and laborious calculations.

velocity of 50 miles per hour, we speak of a vector quantity.

Vectors, representing forces, speeds, displacements, etc., are represented by arrows. They can be added graphically by well known methods illustrated in Figure 22. We can make the parallelogram of forces or we can simply draw a triangle. The addition of many vectors can be accomplished graphically as in the same figure.

In order that we may define vectors algebraically and add, subtract, multiply, or divide them, we must have a logical notation system that lends itself to these operations. For this purpose vectors can be defined by coordinate systems. Both the Cartesian and the polar coordinates are in use.

Vectors Defined by Cartesian Coordinates

Since we have seen how the sum of two vectors is obtained, it follows from Figure 23, that the vector \hat{Z}

equals the sum of the two vectors \hat{x} and \hat{y} . In fact, any vector can be resolved into vectors along the X- and Y-axis. For convenience in working with these quantities we need to dis-

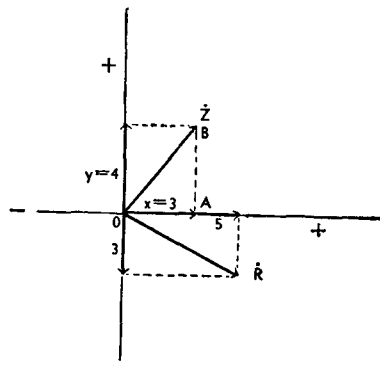

Figure 23.

RESOLUTION OF VECTORS.

Any vector such as \hat{Z} may be resolved into two vectors, \hat{x} and \hat{y} , along the X- and Y-axes. If vectors are to be added, their respective \hat{x} and \hat{y} components may be added to find the \hat{x} and \hat{y} components of the resultant vector.

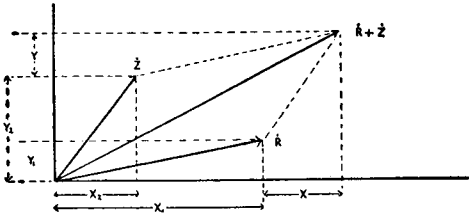

Figure 24.
ADDITION OR SUBTRACTION OF VECTORS.

Vectors may be added or subtracted by adding or subtracting their *x* or *y* components separately.

tinguish between the *X*- and *Y*-component, and so it has been agreed that the *Y*-component alone shall be marked with the letter *j*. Example (Figure 23):

$$\dot{Z} = 3 + 4j$$

Note again that the sign of components along the *X*-axis is positive when measured from 0 to the right and negative when measured from 0 towards the left. Also, the component along the *Y*-axis is positive when measured from 0 upwards, and negative when measured from 0 downwards. So the vector, \dot{R} , is described as

$$\dot{R} = 5 - 3j$$

Vector quantities are usually indicated by some special typography, especially by using a point over the letter indicating the vector, as \dot{R} .

Absolute Value of a Vector The absolute or scalar value of vectors such as \dot{Z} or \dot{R} in Figure 23 is easily found by the theorem of Pythagoras, which states that in any right-angled triangle the square of the side opposite the right angle is equal to the sum of the squares of the sides adjoining the right angle. In Figure 23, *OAB* is a right-angled triangle; therefore, the square of *OB* (or *Z*) is equal to the square of *OA* (or *x*) plus the square of *AB* (or *y*). Thus the absolute values of *Z* and *R* may be determined as follows:

$$|Z| = \sqrt{x^2 + y^2}$$

$$|Z| = \sqrt{3^2 + 4^2} = 5$$

$$|R| = \sqrt{5^2 + 3^2} = \sqrt{34} = 5.83$$

The vertical lines indicate that the absolute or scalar value is meant without regard to sign or direction.

Addition of Vectors An examination of Figure 24 will show that the two vectors

$$\dot{R} = x_1 + jy_1$$

$$\dot{Z} = x_2 + jy_2$$

can be added, if we add the *X*-components and the *Y*-components separately.

$$\dot{R} + \dot{Z} = x_1 + x_2 + j(y_1 + y_2)$$

For the same reason we can carry out subtraction by subtracting the horizontal components and subtracting the vertical components

$$\dot{R} - \dot{Z} = x_1 - x_2 + j(y_1 - y_2)$$

Let us consider the operator *j*. If we have a vector *a* along the *X*-axis and add a *j* in front of it (multiplying by *j*) the result is that the direction of the vector is rotated forward 90 degrees. If we do this twice (multiplying by *j*²) the vector is rotated forward by 180 degrees and now has the value *-a*. Therefore multiplying by *j*² is equivalent to multiplying by *-1*. Then

$$j^2 = -1 \text{ and } j = \sqrt{-1}$$

This is the imaginary number discussed before under algebra. In electrical engineering the letter *j* is used rather than *i*, because *i* is already known as the symbol for current.

Multiplying Vectors When two vectors are to be multiplied we can perform the operation just as in algebra, remembering that *j*² = *-1*.

$$\begin{aligned} \dot{R}\dot{Z} &= (x_1 + jy_1)(x_2 + jy_2) \\ &= x_1x_2 + jx_1y_2 + jx_2y_1 + j^2y_1y_2 \\ &= x_1x_2 - y_1y_2 + j(x_1y_2 + x_2y_1) \end{aligned}$$

Division has to be carried out so as to remove the *j*-term from the denominator. This can be done by multiplying both denominator and numerator by a quantity which will eliminate *j* from the denominator. Example:

$$\begin{aligned} \frac{\dot{R}}{\dot{Z}} &= \frac{x_1 + jy_1}{x_2 + jy_2} = \frac{(x_1 + jy_1)(x_2 - jy_2)}{(x_2 + jy_2)(x_2 - jy_2)} \\ &= \frac{x_1x_2 + y_1y_2 + j(x_2y_1 - x_1y_2)}{x_2^2 + y_2^2} \end{aligned}$$

Polar Coordinates A vector can also be defined in polar coordinates by its magnitude and its vectorial angle with an arbitrary reference axis. In Figure 25

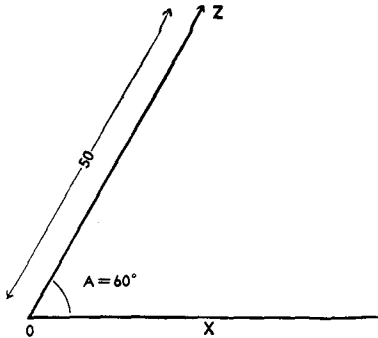

Figure 25.

IN THIS FIGURE A VECTOR HAS BEEN REPRESENTED IN POLAR INSTEAD OF CARTESIAN COORDINATES.

In polar coordinates a vector is defined by a magnitude and an angle, called the vectorial angle, instead of by two magnitudes as in Cartesian coordinates.

the vector \dot{Z} has a magnitude 50 and a vectorial angle of 60 degrees. This will then be written

$$\dot{Z} = 50 \angle 60^\circ$$

A vector $a + jb$ can be transformed into polar notation very simply (see Figure 26)

$$\dot{Z} = a + jb = \sqrt{a^2 + b^2} \angle \tan^{-1} \frac{b}{a}$$

In this connection \tan^{-1} means the angle of which the tangent is. Sometimes the notation arc tan b/a is used. Both have the same meaning.

A polar notation of a vector can be transformed into a Cartesian coordinate notation in the following manner (Figure 27)

$$\dot{Z} = p \angle A = p \cos A + jp \sin A$$

A sinusoidally alternating voltage or current is symbolically represented by a rotating vector, having a magnitude equal to the peak voltage or current and rotating with an angular velocity of $2\pi f$ radians per second or as many revolutions per second as there are cycles per second.

The instantaneous voltage, e , is always equal to the sine of the vectorial angle of this rotating vector, multiplied by its magnitude.

$$e = E \sin 2\pi ft$$

The alternating voltage therefore varies with time as the sine varies with the angle. If we plot time horizontally and instantaneous voltage vertically we will get a curve like those in Figure 18.

In alternating current circuits, the current

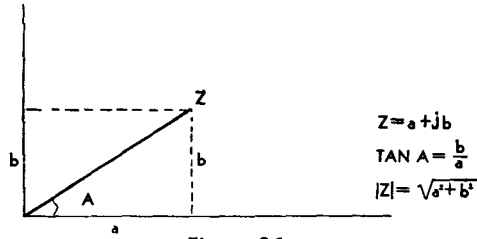

Figure 26.

Vectors can be transformed from Cartesian into polar notation as shown in this figure.

which flows due to the alternating voltage is not necessarily in step with it. The rotating current vector may be ahead or behind the voltage vector, having a *phase difference* with it. For convenience we draw these vectors as if they were standing still, so that we can indicate the difference in phase or the *phase angle*. In Figure 28 the current lags behind the voltage by the angle θ , or we might say that the voltage leads the current by the angle θ .

Vector diagrams show the phase relations between two or more vectors (voltages and currents) in a circuit. They may be added and subtracted as described; one may add a voltage vector to another voltage vector or a current vector to a current vector but not a current vector to a voltage vector (for the same reason that one cannot add a force to a speed). Figure 28 illustrates the relations in the simple series circuit of a coil and resistor. We know that the current passing through coil and resistor must be the same and in the same phase, so we draw this current I along the X-axis. We know also that the voltage drop IR across the resistor is in phase with the current, so the vector IR representing the voltage drop is also along the X-axis.

The voltage across the coil is 90 degrees ahead of the current through it; IX must therefore be drawn along the Y-axis. \dot{E} the applied voltage must be equal to the vectorial sum of the two voltage drops, IR and IX , and we have so constructed it in the drawing. Now expressing the same in algebraic notation, we have

$$\dot{E} = IR + jIX$$

$$\dot{I}Z = IR + jIX$$

Dividing by I

$$Z = R + jX$$

Due to the fact that a *reactance* rotates the voltage vector ahead or behind the current vector by 90 degrees, we must mark it with a j in vector notation. Inductive reactance will have a plus sign because it shifts the voltage vector forwards; a capacitive reactance is neg-

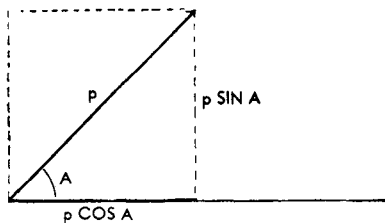

Figure 27.
Vectors can be transformed from polar into Cartesian notation as shown in this figure.

ative because the voltage will lag behind the current. Therefore:

$$X_L = + j 2\pi fL$$

$$X_C = - j \frac{1}{2\pi fC}$$

In Figure 28 the angle θ is known as the phase angle between E and I . When calculating power, only the real components count. The power in the circuit is then

$$P = I (IR)$$

$$\text{but } IR = E \cos \theta$$

$$\therefore P = EI \cos \theta$$

This $\cos \theta$ is known as the power factor of the circuit. In many circuits we strive to keep the angle θ as small as possible, making $\cos \theta$ as near to unity as possible. In tuned circuits, we use reactances which should have as low a power factor as possible. The merit of a coil or condenser, its Q , is defined by the tangent of this phase angle:

$$Q = \tan \theta = X/R$$

For an efficient coil or condenser, Q should be as large as possible; the phase-angle should then be as close to 90 degrees as possible, making the power factor nearly zero. Q is almost but not quite the inverse of $\cos \theta$. Note that in Figure 29

$$Q = X/R \quad \text{and} \quad \cos \theta = R/Z$$

When Q is more than 5, the power factor is less than 20%; we can then safely say $Q = 1/\cos \theta$ with a maximum error of about 2½ percent, for in the worst case, when $\cos \theta = 0.2$, Q will equal $\tan \theta = 4.89$. For higher values of Q , the error becomes less.

Note that from Figure 29 can be seen the simple relation:

$$\dot{Z} = R + jX_L$$

$$|Z| = \sqrt{R^2 + X_L^2}$$

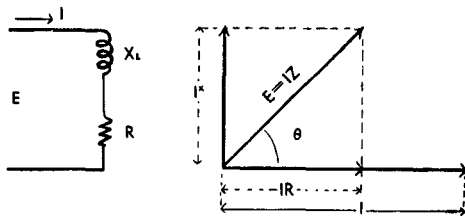

Figure 28.
VECTOR REPRESENTATION OF A SIMPLE SERIES CIRCUIT.

The righthand portion of the illustration shows the vectors representing the voltage drops in the coil and resistance illustrated at the left. Note that the voltage drop across the coil X_L leads that across the resistance by 90°.

Graphical Representation

Formulas and physical laws are often presented in graphical form; this gives us a "bird's eye view" of various possible conditions due to the variations of the quantities involved. In some cases graphs permit us to solve equations with greater ease than ordinary algebra.

Coordinate Systems All of us have used coordinate systems without realizing it. For instance, in modern cities we have numbered streets and numbered avenues. By this means we can define the location of any spot in the city if the nearest street crossings are named. This is nothing but an application of Cartesian coordinates.

In the Cartesian coordinate system (named after Descartes), we define the location of any point in a plane by giving its distance from each of two perpendicular lines or *axes*. Figure 30 illustrates this idea. The vertical axis is called the *Y-axis*, the horizontal axis is the *X-axis*. The intersection of these two axes is called the *origin*, O . The location of a point, P , (Figure 30) is defined by measuring the respective distances, x and y along the X -axis and the Y -axis. In this example the distance along the X -axis is 2 units and along the Y -axis is 3 units. Thus we define the point as

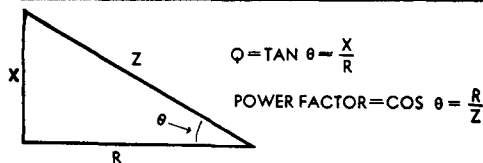

Figure 29.

The figure of merit of a coil and its resistance is represented by the ratio of the inductive reactance to the resistance, which as shown in this diagram is equal to $\frac{X}{R}$ which equals $\tan \theta$. For large values of θ (the phase angle) this is approximately equal to the reciprocal of the $\cos \theta$.

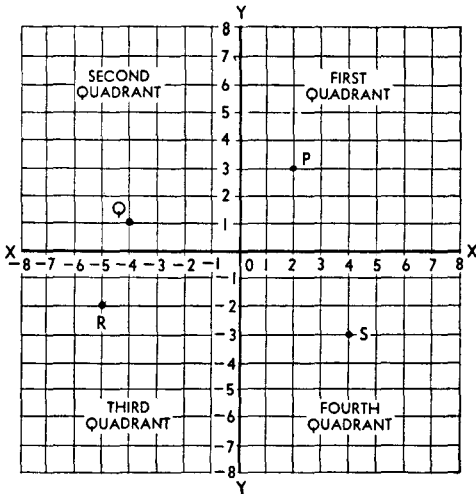

Figure 30.

CARTESIAN COORDINATES.

The location of any point can be defined by its distance from the X and Y axes.

P 2, 3 or we might say $x = 2$ and $y = 3$. The measurement x is called the *abscissa* of the point and the distance y is called its *ordinate*. It is arbitrarily agreed that distances measured from 0 to the right along the X-axis shall be reckoned positive and to the left negative. Distances measured along the Y-axis are positive when measured upwards from 0 and negative when measured downwards from 0. This is illustrated in Figure 30. The two axes divide the plane area into four parts called quadrants. These four quadrants are numbered as shown in the figure.

It follows from the foregoing statements, that points lying within the first quadrant have both x and y positive, as is the case with the point P. A point in the second quadrant has a negative abscissa, x , and a positive ordinate, y . This is illustrated by the point Q, which has the coordinates $x = -4$ and $y = +1$. Points in the third quadrant have both x and y negative. $x = -5$ and $y = -2$ illustrates such a point, R. The point S, in the fourth quadrant has a negative ordinate, y and a positive abscissa or x .

In practical applications we might draw only as much of this plane as needed to illustrate our equation and therefore, the scales along the X-axis and Y-axis might not start with zero and may show only that part of the scale which interests us.

Representation of Functions In the equation:

$$f = \frac{300,000}{\lambda}$$

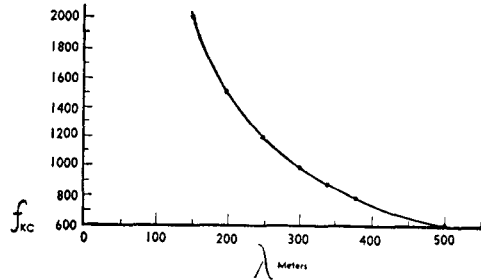

Figure 31.

REPRESENTATION OF A SIMPLE FUNCTION IN CARTESIAN COORDINATES.

In this chart of the function $f_{kc} = \frac{300,000}{\lambda_{meters}}$ distances along the X axis represent wavelength in meters, while those along the Y axis represent frequency in kilocycles. A curve such as this helps to find values between those calculated with sufficient accuracy for most purposes.

f is said to be a function of λ . For every value of f there is a definite value of λ . A variable is said to be a function of another variable when for every possible value of the latter, or *independent* variable, there is a definite value of the first or *dependent* variable. For instance, if $y = 5x^2$, y is a function of x and x is called the independent variable. When $a = 3b^3 + 5b^2 - 25b + 6$ then a is a function of b .

A function can be illustrated in our coordinate system as follows. Let us take the equation for frequency versus wavelength as an example. Given different values to the independent variable find the corresponding values of the dependent variable. Then plot the *points* represented by the different sets of two values.

f_{kc}	λ_{meters}
600	500
800	375
1000	300
1200	250
1400	214
1600	187
1800	167
2000	150

Plotting these points in Figure 31 and drawing a smooth curve through them gives us the *curve* or *graph* of the equation. This curve will help us find values of f for other values of λ (those in between the points calculated) and so a curve of an often-used equation may serve better than a table which always has gaps.

When using the coordinate system described so far and when measuring linearly along both axes, there are some definite rules regarding

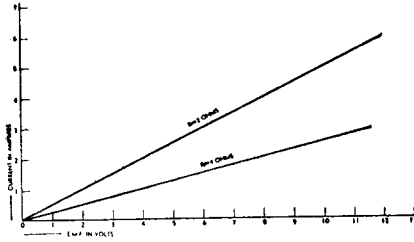

Figure 32.

Only two points are needed to define functions which result in a straight line as shown in this diagram representing Ohm's Law.

the kind of curve we get for any type of equation. In fact, an expert can draw the curve with but a very few plotted points since the equation has told him what kind of curve to expect.

First, when the equation can be reduced to the form $y = mx + b$, where x and y are the variables, it is known as a *linear* or *first degree* function and the curve becomes a straight line. (Mathematicians still speak of a "curve" when it has become a straight line.)

When the equation is of the second degree, that is, when it contains terms like x^2 or y^2 or xy , the graph belongs to a group of curves, called *conic sections*. These include the circle, the ellipse, the parabola and the hyperbola. In the example given above, our equation is of the form

$$xy = c, \quad c \text{ being equal to } 300,000$$

which is a second degree equation and in this case, the graph is a hyperbola.

This type of curve does not lend itself readily for the purpose of calculation except near the middle, because at the ends a very large change in λ represents a small change in f and vice versa. Before discussing what can be done about this let us look at some other types of curves.

Suppose we have a resistance of 2 ohms and we plot the function represented by Ohm's Law: $E = 2I$. Measuring E along the X-axis and amperes along the Y-axis, we plot the necessary points. Since this is a first degree equation, of the form $y = mx + b$ (for $E = y$, $m = 2$ and $I = x$ and $b = 0$) it will be a straight line so we need only two points to plot it.

	I	E
(line passes through origin)	0	0
	5	10

The line is shown in Figure 32. It is seen to be a straight line passing through the origin.

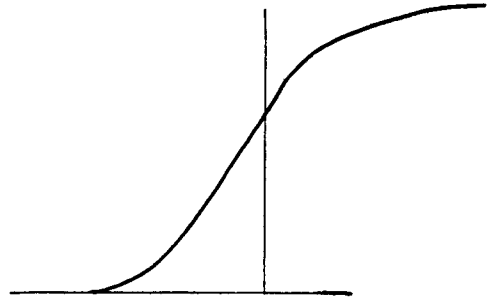

Figure 33.

A TYPICAL GRID - VOLTAGE PLATE-CURRENT CHARACTERISTIC CURVE.

The equation represented by such a curve is so complicated that we do not use it. Data for such a curve is obtained experimentally, and intermediate values can be found with sufficient accuracy from the curve.

If the resistance were 4 ohms, we should get the equation $E = 4I$ and this also represents a line which we can plot in the same figure. As we see, this line also passes through the origin but has a different slope. In this illustration the slope defines the resistance and we could make a protractor which would convert the angle into ohms. This fact may seem inconsequential now, but use of this is made in the drawing of loadlines on tube curves.

Figure 33 shows a typical, grid-voltage, plate-current static characteristic of a triode. The equation represented by this curve is rather complicated so that we prefer to deal with the curve. Note that this curve extends through the first and second quadrant.

Families of curves. It has been explained that curves in a plane can be made to illustrate the relation between two variables when one of them varies independently. However, what are we going to do when there are three variables and two of them vary independently. It is possible to use three dimensions and three axes but this is not conveniently done. Instead of this we may use a *family of curves*. We have already illustrated this partly with Ohm's Law. If we wish to make a chart which will show the current through any resistance with any voltage applied across it, we must take the equation $E = IR$, having three variables.

We can now draw one line representing a resistance of 1 ohm, another line representing 2 ohms, another representing 3 ohms, etc., or as many as we wish and the size of our paper will allow. The whole set of lines is then applicable to any case of Ohm's Law falling within the range of the chart. If any two of the three quantities are given, the third can be found.

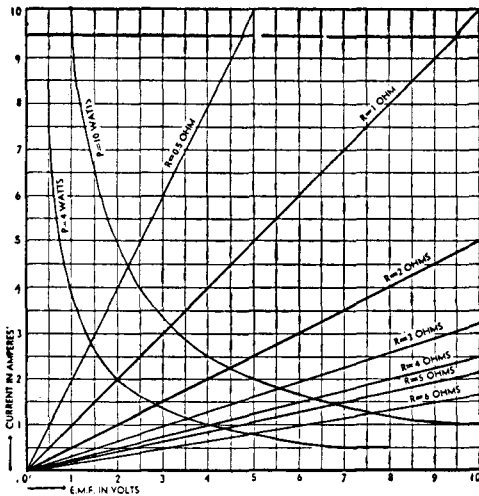

Figure 34.
A FAMILY OF CURVES.

An equation such as Ohm's Law has three variables, but can be represented in Cartesian coordinates by a family of curves such as shown here. If any two quantities are given, the third can be found. Any point in the chart represents a definite value each of E , I , and R , which will satisfy the equation of Ohm's Law. Values of R not situated on an R line can be found by interpolation.

Figure 34 shows such a family of curves to solve Ohm's Law. Any point in the chart represents a definite value each of E , I , and R which will satisfy the equation. The value of R represented by a point that is not situated on an R line can be found by interpolation.

It is even possible to draw on the same chart a second family of curves, representing a fourth variable. But this is not always possible, for among the four variables there should be no more than *two independent variables*. In our example such a set of lines could represent power in watts; we have drawn only two of these but there could of course be as many as desired. A single point in the plane now indicates the four values of E , I , R , and P which belong together and the knowledge of any two of them will give us the other two by reference to the chart.

Another example of a family of curves is the dynamic transfer characteristic or *plate family* of a tube. Such a chart consists of several curves showing the relation between plate voltage, plate current, and grid bias of a tube. Since we have again three variables, we must show several curves, each curve for a fixed value of one of the variables. It is customary to plot plate voltage along the X-axis, plate current along the Y-axis, and to make different curves for various values of grid bias. Such a

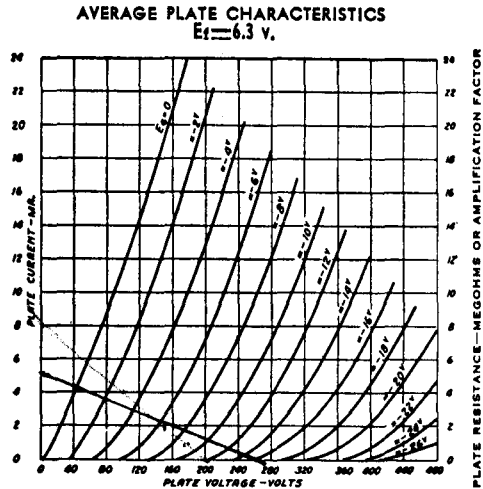

Figure 35.
"PLATE" CURVES FOR A TYPICAL VACUUM TUBE.

In such curves we have three variables, plate voltage, plate current, and grid bias. Each point on a grid bias line corresponds to the plate voltage and plate current represented by its position with respect to the X and Y axes. Those for other values of grid bias may be found by interpolation. The loadline shown in the lower left portion of the chart is explained in the text.

set of curves is illustrated in Figure 35. Each point in the plane is defined by three values, which belong together, plate voltage, plate current, and grid voltage.

Now consider the diagram of a resistance-coupled amplifier in Figure 36. Starting with the B-supply voltage, we know that whatever plate current flows must pass through the resistor and will conform to Ohm's Law. The voltage drop across the resistor is subtracted from the plate supply voltage and the remainder is the actual voltage at the plate, the kind that is plotted along the X-axis in Figure 35. We can now plot on the plate family of the

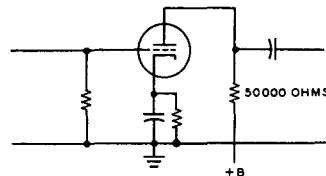

Figure 36.
PARTIAL DIAGRAM OF A RESISTANCE COUPLED AMPLIFIER.

The portion of the supply voltage wasted across the 50,000-ohm resistor is represented in Figure 35 as the loadline.

tube the *loadline*, that is the line showing which part of the plate supply voltage is across the resistor and which part across the tube for any value of plate current. In our example, let us suppose the plate resistor is 50,000 ohms. Then, if the plate current were zero, the voltage drop across the resistor would be zero and the full plate supply voltage is across the tube. Our first point of the loadline is $E = 250$, $I = 0$. Next, suppose, the plate current were 1 ma., then the voltage drop across the resistor would be 50 volts, which would leave for the tube 200 volts. The second point of the loadline is then $E = 200$, $I = 1$. We can continue like this but it is unnecessary for we shall find that it is a straight line and two points are sufficient to determine it.

This loadline shows at a glance what happens when the grid-bias is changed. Although there are many possible combinations of plate voltage, plate current, and grid bias, we are now restricted to points along this line as long as the 50,000 ohm plate resistor is in use. This line therefore shows the voltage drop across the tube as well as the voltage drop across the load for every value of grid bias. Therefore, if we know how much the grid bias varies, we can calculate the amount of variation in the plate voltage and plate current, the amplification, the power output, and the distortion.

Logarithmic Scales Sometimes it is convenient to measure along the axes the *logarithms* of our variable quantities. Instead of actually calculating the logarithm, special paper is available with logarithmic scales, that is, the distances measured along the axes are proportional to the logarithms of the numbers marked on them rather than to the numbers themselves.

There is semi-logarithmic paper, having logarithmic scales along one axis only, the other scale being linear. We also have full logarithmic paper where both axes carry logarithmic scales. Many curves are greatly simplified and some become straight lines when plotted on this paper.

As an example let us take the wavelength-frequency relation, charted before on straight cross-section paper.

$$f = \frac{300,000}{\lambda}$$

Taking logarithms:

$$\log f = \log 300,000 - \log \lambda$$

If we plot $\log f$ along the Y-axis and $\log \lambda$ along the X-axis, the curve becomes a straight line. Figure 37 illustrates this graph on full logarithmic paper. The graph may be read with the same accuracy at any point in con-

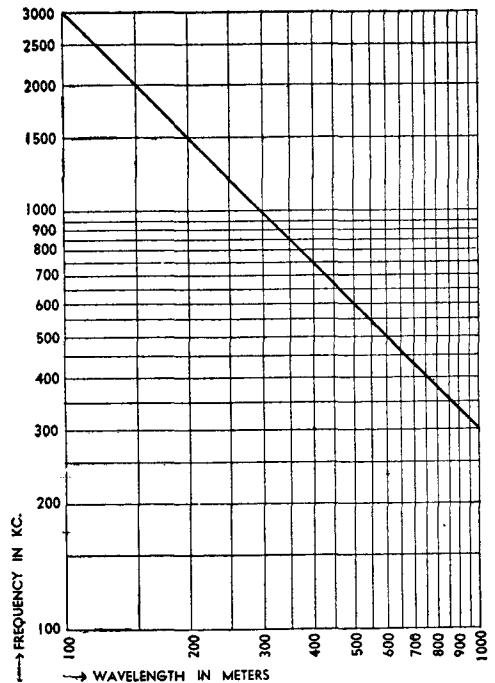

Figure 37.
A LOGARITHMIC CURVE.

Many functions become greatly simplified and some become straight lines when plotted to logarithmic scales such as shown in this diagram. Here the frequency versus wavelength curve of Figure 31 has been replotted to conform with logarithmic axes. Note that it is only necessary to calculate two points in order to determine the "curve" since this type of function results in a straight line.

trast to the graph made with linear coordinates.

This last fact is a great advantage of logarithmic scales in general. It should be clear that if we have a linear scale with 100 small divisions numbered from 1 to 100, and if we are able to read to one tenth of a division, the possible error we can make near 100, way up the scale, is only 1/10th of a percent. But near the beginning of the scale, near 1, one tenth of a division amounts to 10 percent of 1 and we are making a 10 percent error.

In any logarithmic scale, our possible error in measurement or reading might be, say 1/32 of an inch which represents a fixed amount of the log depending on the scale used. The net result of adding to the logarithm a fixed quantity, as 0.01, is that the anti-logarithm is multiplied by 1.025, or the error is 2½%. No matter at what part of the scale the 0.01 is added, the error is always 2½%.

An example of the advantage due to the use

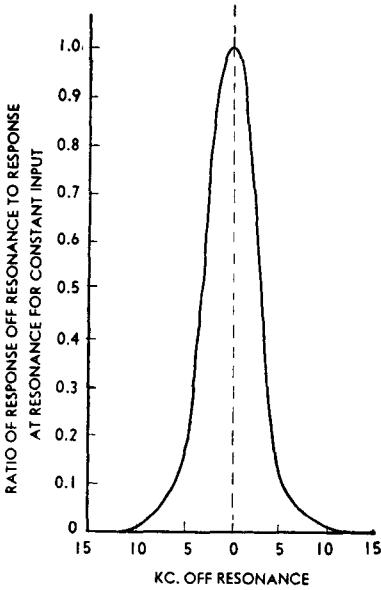

Figure 38.

A RECEIVER RESONANCE CURVE.

This curve represents the output of a receiver versus frequency when plotted to linear coordinates.

of semi-logarithmic paper is shown in Figures 38 and 39. A resonance curve, when plotted on linear coordinate paper will look like the curve in Figure 38. Here we have plotted the output of a receiver against frequency while the applied voltage is kept constant. It is the kind of curve a "wobbulator" will show. The curve does not give enough information in this form for one might think that a signal 10 kc. off resonance would not cause any current at all and is tuned out. However, we frequently have off resonance signals which are 1000 times as strong as the desired signal and one cannot read on the graph of Figure 38 how much any signal is attenuated if it is reduced more than about 20 times.

In comparison look at the curve of Figure 39. Here the response (the current) is plotted in logarithmic proportion, which allows us to plot clearly how far off resonance a signal has to be to be reduced 100, 1,000, or even 10,000 times.

Note that this curve is now "upside down"; it is therefore called a *selectivity curve*. The reason that it appears upside down is that the method of measurement is different. In a selectivity curve we plot the increase in signal voltage necessary to cause a standard output off resonance. It is also possible to plot this increase along the Y-axis in decibels; the curve then looks the same although linear paper can

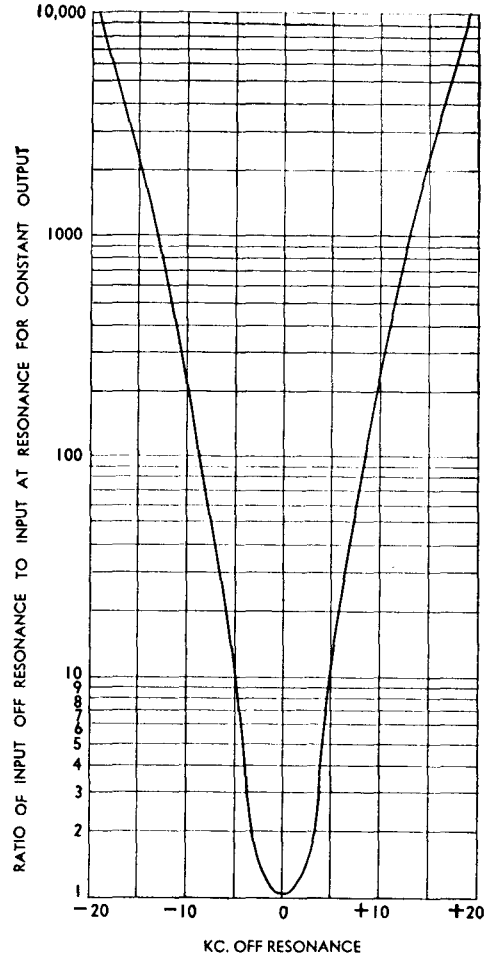

Figure 39.

A RECEIVER SELECTIVITY CURVE.

This curve represents the selectivity of a receiver plotted to logarithmic coordinates for the output, but linear coordinates for frequency. The reason that this curve appears inverted from that of Figure 38 is explained in the text.

be used because now our unit is logarithmic.

An example of full logarithmic paper being used for families of curves is shown in the resistance charts of Figures 40 and 41.

Nomograms or Alignment Charts

An alignment chart consists of three or more sets of scales which have been so laid out that to solve the formula for which the chart was made, we have but to lay a straight edge along the two given values on any two of the scales, to find the third and unknown value on the third scale. In its sim-

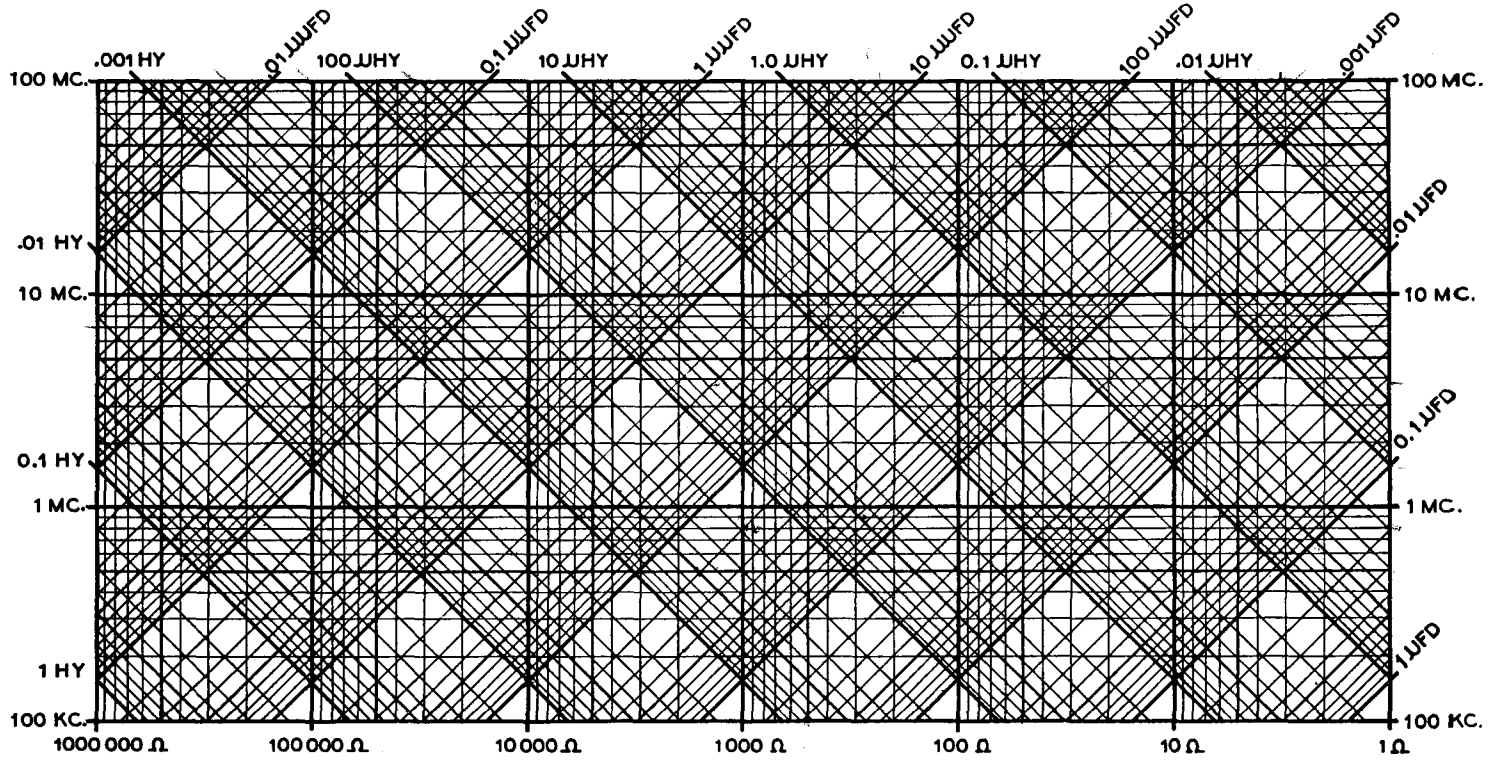

Figure 41.

REACTANCE-FREQUENCY CHART FOR R.F.

This chart is used in conjunction with the nomograph on page 569 for radio frequency tank coil computations.

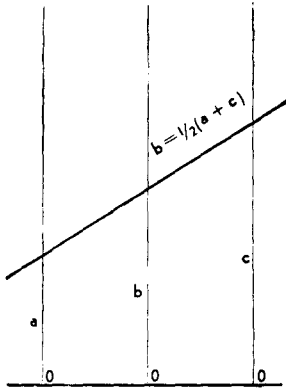

Figure 42.
THE SIMPLEST FORM OF NOMOGRAM.

plest form, it is somewhat like the lines in Figure 42. If the lines *a*, *b*, and *c* are parallel and equidistant, we know from ordinary geometry, that $b = \frac{1}{2}(a + c)$. Therefore, if we draw a scale of the same units on all three lines, starting with zero at the bottom, we know that by laying a straight-edge across the chart at any place, it will connect values of *a*, *b*, and *c*, which satisfy the above equation. When any two quantities are known, the third can be found.

If, in the same configuration we used logarithmic scales instead of linear scales, the relation of the quantities would become

$$\log b = \frac{1}{2}(\log a + \log c) \text{ or } b = \sqrt{ac}$$

By using different kinds of scales, different units, and different spacings between the scales, charts can be made to solve many kinds of equations.

If there are more than three variables it is generally necessary to make a double chart, that is, to make the result from the first chart serve as the given quantity of the second one. Such an example is the chart for the design of coils illustrated in Figure 45. This nomogram is used to convert the inductance in microhenries to physical dimensions of the coil and vice versa. A pin and a straight edge are required. The method is shown under "R. F. Tank Circuit Calculations" later in this chapter.

Polar Coordinates Instead of the Cartesian coordinate system there is also another system for defining algebraically the location of a point or line in a plane. In this, the polar coordinate system, a point is determined by its distance from the origin, *O*, and by the angle it makes with the axis *O-X*. In Figure 43 the point *P* is defined by the length of *OP*, known as the radius vector and

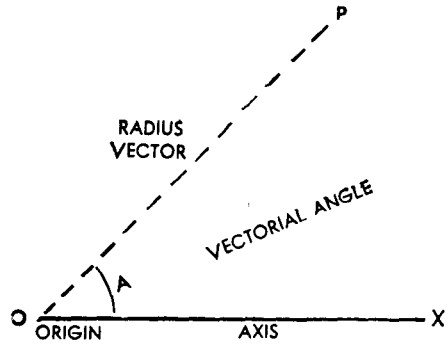

Figure 43.
THE LOCATION OF A POINT BY POLAR COORDINATES.

In the polar coordinate system any point is determined by its distance from the origin and the angle formed by a line drawn from it to the origin and the O-X axis.

by the angle *A* the vectorial angle. We give these data in the following form

$$P = 3 \angle 60^\circ$$

Polar coordinates are used in radio chiefly for the plotting of directional properties of microphones and antennas. A typical example of such a directional characteristic is shown in Figure 44. The radiation of the antenna represented here is proportional to the distance of the characteristic from the origin for every possible direction.

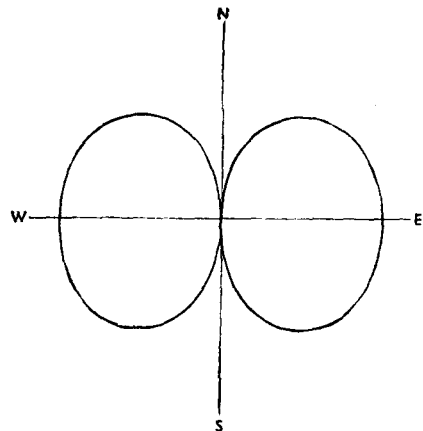

Figure 44.
THE RADIATION CURVE OF AN ANTENNA.

Polar coordinates are used principally in radio work for plotting the directional characteristics of an antenna where the radiation is represented by the distance of the curve from the origin for every possible direction.

Reactance Calculations

In audio frequency calculations, an accuracy to better than a few per cent is seldom required, and when dealing with calculations involving inductance, capacitance, resonant frequency, etc., it is much simpler to make use of reactance-frequency charts such as those in figures 40 and 41 rather than to wrestle with a combination of unwieldy formulas. From these charts it is possible to determine the reactance of a condenser or coil if the capacitance or inductance is known, and vice versa. It follows from this that resonance calculations can be made directly from the chart, because resonance simply means that the inductive and capacitive reactances are equal. The capacity required to resonate with a given inductance, or the inductance required to resonate with a given capacity, can be taken directly from the chart.

While the chart may look somewhat formidable to one not familiar with charts of this type, its application is really quite simple, and can be learned in a short while. The following example should clarify its interpretation.

For instance, following the lines to their intersection, we see that 0.1 hy. and 0.1 μ fd. intersect at approximately 1,500 cycles and 1,000 ohms. Thus, the reactance of either the coil or condenser taken alone is about 1000 ohms, and the resonant frequency about 1,500 cycles.

To find the reactance of 0.1 hy. at, say, 10,000 cycles, simply follow the inductance line diagonally up towards the upper left till it intersects the horizontal 10,000 kc. line. Following vertically downward from the point of intersection, we see that the reactance at this frequency is about 6000 ohms.

To facilitate use of the chart and to avoid errors, simply keep the following in mind: The vertical lines indicate reactance in ohms, the horizontal lines always indicate the frequency, the diagonal lines sloping to the lower right represent inductance, and the diagonal lines sloping toward the lower left indicate capacitance. Also remember that the scale is *logarithmic*. For instance, the next horizontal line above 1000 cycles is 2000 cycles. Note that there are 9, not 10, divisions between the heavy lines. This also should be kept in mind when interpolating between lines when best possible accuracy is desired; halfway between the line representing 200 cycles and the line representing 300 cycles is *not* 250 cycles, but approximately 230 cycles. The 250 cycle point is approximately 0.7 of the way between the 200 cycle line and the 300 cycle line, rather than halfway between.

Use of the chart need not be limited by the physical boundaries of the chart. For instance, the 10- μ fd. line can be extended to find where

it intersects the 100-hy. line, the resonant frequency being determined by projecting the intersection horizontally back on to the chart. To determine the reactance, the logarithmic ohms scale must be extended.

R. F. Tank Circuit Calculations When winding coils for use in radio receivers and transmitters, it is desirable to be able to determine in advance the full coil specifications for a given frequency. Likewise, it often is desired to determine how much capacity is required to resonate a given coil so that a suitable condenser can be used.

Fortunately, extreme accuracy is not required, except where fixed capacitors are used across the tank coil with no provision for trimming the tank to resonance. Thus, even though it may be necessary to estimate the stray circuit capacity present in shunt with the tank capacity, and to take for granted the likelihood of a small error when using a chart instead of the formula upon which the chart was based, the results will be sufficiently accurate in most cases, and in any case give a reasonably close point from which to start "pruning."

The inductance required to resonate with a certain capacitance is given in the chart in figure 41. By means of the r.f. chart, the inductance of the coil can be determined, or the capacitance determined if the inductance is known. When making calculations, be sure to allow for stray circuit capacity, such as tube interelectrode capacity, wiring, sockets, etc. This will normally run from 5 to 25 micro-microfarads, depending upon the components and circuit.

To convert the inductance in microhenries to physical dimensions of the coil, or vice versa, the nomograph chart in figure 41 is used. A pin and a straightedge are required. The inductance of a coil is found as follows:

The straightedge is placed from the correct point on the turns column to the correct point on the diameter-to-length ratio column, the latter simply being the diameter divided by the length. Place the pin at the point on the plot axis column where the straightedge crosses it. From this point lay the straightedge to the correct point on the diameter column. The point where the straightedge intersects the inductance column will give the inductance of the coil.

From the chart, we see that a 30 turn coil having a diameter-to-length ratio of 0.7 and a diameter of 1 inch has an inductance of approximately 12 microhenries. Likewise any one of the four factors may be determined if the other three are known. For instance, to determine the number of turns when the desired in-

Figure 45. COIL CALCULATOR NOMOGRAPH

For single layer solenoid coils, any wire size. See text for instructions.

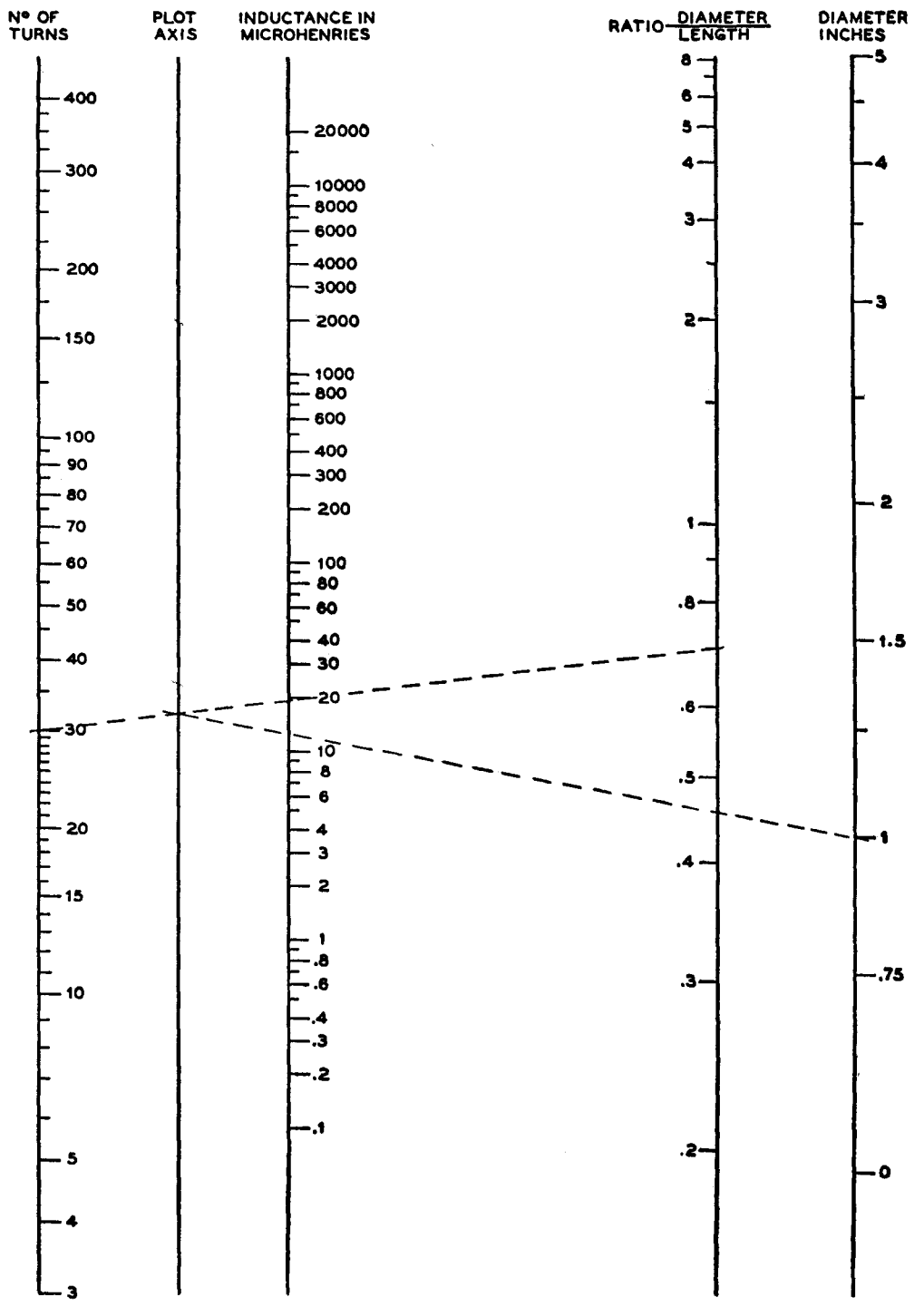

ductance, the D/L ratio, and the diameter are known, simply work backwards from the example given. In all cases, remember that the straightedge reads either turns and D/L ratio, or it reads inductance and diameter. It can read no other combination.

The actual wire size has negligible effect upon the calculations for commonly used wire sizes (no. 10 to no. 30). The number of turns of insulated wire that can be wound per inch (solid) will be found in a copper wire table.

Significant Figures

In most radio calculations, numbers represent quantities which were obtained by measurement. Since no measurement gives absolute accuracy, such quantities are only approximate and their value is given only to a few significant figures. In calculations, these limitations must be kept in mind and one should not finish for instance with a result expressed in more significant figures than the given quantities at the beginning. This would imply a greater accuracy than actually was obtained and is therefore misleading, if not ridiculous.

An example may make this clear. Many ammeters and voltmeters do not give results to closer than 1/4 ampere or 1/4 volt. Thus if we have 2 3/4 amperes flowing in a d.c. circuit at 6 3/4 volts, we can obtain a theoretical answer by multiplying 2.25 by 6.75 to get 15.1875 watts. But it is misleading to express the answer down to a ten-thousandth of a watt when the original measurements were only good to 1/4 ampere or volt. The answer should be expressed as 15 watts, not even 15.0 watts. If we assume a possible error of 1/8 volt or ampere (that is, that our original data are only correct to the nearest 1/4 volt or ampere) the true power lies between 14.078 (product of 2 1/8 and 6 5/8) and 16.328 (product of 2 3/8 and 6 7/8). Therefore, any third significant figure would be misleading as implying an accuracy which we do not have.

Conversely, there is also no point to calculating the value of a part down to 5 or 6 significant figures when the actual part to be used cannot be measured to better than 1 part in one hundred. For instance, if we are going to use 1% resistors in some circuit, such as an ohmmeter, there is no need to calculate the value of such a resistor to 5 places, such as 1262.5 ohm. Obviously, 1% of this quantity is over 12 ohms and the value should simply be written as 1260 ohms.

There is a definite technique in handling these approximate figures. When giving values obtained by measurement, no more figures are

given than the accuracy of the measurement permits. Thus, if the measurement is good to two places, we would write, for instance, 6.9 which would mean that the true value is somewhere between 6.85 and 6.95. If the measurement is known to three significant figures, we might write 6.90 which means that the true value is somewhere between 6.895 and 6.905. In dealing with approximate quantities, the added cipher at the right of the decimal point has a meaning.

There is unfortunately no standardized system of writing approximate figures with many ciphers to the left of the decimal point. 69000 does not necessarily mean that the quantity is known to 5 significant figures. Some indicate the accuracy by writing 69×10^3 or 690×10^2 etc., but this system is not universally employed. The reader can use his own system, but whatever notation is used, the number of significant figures should be kept in mind.

Working with approximate figures, one may obtain an idea of the influence of the doubtful figures by marking all of them, and products or sums derived from them. In the following example, the doubtful figures have been underlined.

$$\begin{array}{r}
 603 \\
 \underline{34.6} \\
 \underline{0.120} \\
 \hline
 637.720 \quad \text{answer: } 638
 \end{array}$$

Multiplication:

$$\begin{array}{r}
 654 \\
 \underline{0.342} \\
 \hline
 1308 \\
 \underline{2616} \\
 \underline{1962} \\
 \hline
 223.668 \quad \text{answer: } 224
 \end{array}
 \qquad
 \begin{array}{r}
 654 \\
 \underline{0.342} \\
 \hline
 196|2 \\
 \underline{26|16} \\
 \underline{1|308} \\
 \hline
 224
 \end{array}$$

It is recommended that the system at the right be used and that the figures to the right of the vertical line be omitted or guessed so as to save labor. Here the partial products are written in the reverse order, the most important ones first.

In division, labor can be saved when after each digit of the quotient is obtained, one figure of the divisor be dropped. Example:

$$\begin{array}{r}
 1.28 \\
 527 \overline{) 673} \\
 \underline{527} \\
 146 \\
 53 \overline{) 146} \\
 \underline{106} \\
 40 \\
 5 \overline{) 40} \\
 \underline{40}
 \end{array}$$

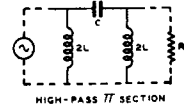
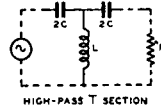
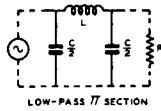
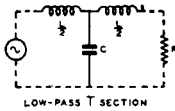

FREQUENCY SCALE
LOW-PASS HIGH-PASS

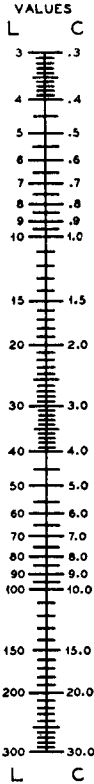
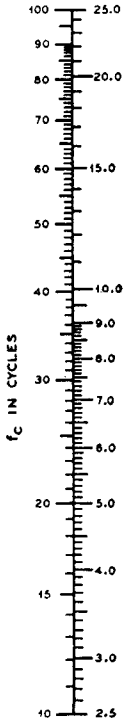

LOAD RESISTANCE

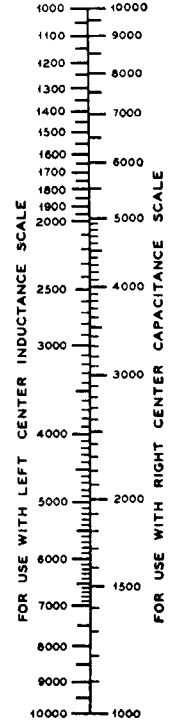

Courtesy, Pacific Radio Publishing Co.

FILTER DESIGN CHART

For both Pi-type and T-type Sections

To find L , connect cut-off frequency on left-hand scale (using left-side scale for low-pass and right-side scale for high-pass) with load on left-hand side of right-hand scale by means of a straight-edge. Then read the value of L from the point where the edge intersects the left side of the center scale. Readings are in henries for frequencies in cycles per second.

To find C , connect cut-off frequency on left-hand scale (using left-side scale for low-pass and right-side scale for high-pass) with load on the right-hand side of the right-hand scale. Then read the value of C from the point where the straightedge cuts the right side of the center scale. Readings are in microfarads for frequencies in cycles per second.

For frequencies in kilocycles, C is expressed in thousands of micromicrofarads, L is expressed in millihenries. For frequencies in megacycles, L is expressed in microhenries and C is expressed in micromicrofarads.

For each tenfold increase in the value of load resistance multiply L by 10 and divide C by 10. For each tenfold decrease in frequency multiply L by 10 and multiply C by 10.

INDEX

A

Acceptor, def. of.....	92	Amplifier — Push-pull	121, 612
A.C.-D.C. power supply.....	561, 588, 694	" Push-pull tetrode.....	644
"Acorn" tube.....	232	" R-F — RC.....	121, 109
A-C V-T voltmeter.....	724	" Response.....	112
Adapter, F-M.....	325	" R-F — 4CX-1000A.....	213, 640
Adapter, mechanical filter.....	535	" Summing.....	201
Admittance, def. of.....	52	" Terman-Woodyard	298
"A"-frame antenna mast.....	448	" Tetrode.....	614
Air capacitor.....	359	" Transistor.....	104
Air dielectric.....	32	" Ultra-linear.....	142
Air-gap, capacitor.....	264	" Vertical.....	138
Alignment — B.f.o — Filter.....	236	" V.h.f. cascode.....	578
" Receiver — I-F — R-F.....	148, 235, 236	" Video.....	112, 113, 128
All-driven antenna.....	504	" Voltage.....	110
Alpha, def. of.....	93	" Williamson.....	140
Alternating current — Amplitude — Average.....	45	Amplitude — A.C.....	45
" Def. of — Effective value.....	41, 45	" Distortion — Modulation.....	109, 282, 647
" Generation.....	42	Analog computers — problems.....	195, 200
" Impedance — "J" operator.....	47	Angle of radiation — V.h.f.....	411, 460, 478
" Ohm's law — Phase angle.....	45, 46	Anode, def. of — dissipation.....	67, 72
" Pulsating — R.M.S.....	45	Antenna — Adjustment.....	509
" Transformer.....	61	" All-driven.....	504
" Transient.....	59	" Bandwidth.....	405, 413
" Voltage divider.....	52	" Beam — design chart — 2-element.....	498, 495
Alternator.....	42	" Bidirectional — Bi-square.....	505, 470
Amateur band receiver.....	540	" Bobtail.....	472
Amateur frequency bands — licenses.....	12	" Broadside.....	468
Amateur radio service, The.....	11	" Bruce.....	470
Ammeter.....	721	" Center-fed.....	438
Ampere, def. of.....	22, 23	" Colinear.....	466
Ampere-turns.....	36, 62	" Combinations of.....	475
Amperite filament regulator.....	552	" Construction.....	448, 506
Amplification factor.....	73, 74	" Corner reflector.....	485
Amplifier — Audio — Cascode.....	227, 214	" Couplers — mobile.....	454, 520, 524
" Cathode — Cathode driven.....	127, 626	" Coupling systems.....	451
" Cathode follower.....	134	" Cubical quad.....	471
" Class A — A2.....	99, 108, 118	" Curtain.....	468
" Class AB — AB1.....	108, 137	" Delta match.....	501
" Class B.....	99, 108, 123, 129, 251	" Dipole array — broad-band.....	465, 435
" Class C.....	108, 124, 251	" Directivity.....	404, 410
" Coupling — inductive.....	113, 118, 123	" Discone.....	441, 481
" D.C.....	117	" Doublet.....	427
" Doherty.....	298	" Dummy.....	726
" Driver.....	126	" Efficiency.....	409
" Equivalent circuit.....	109	" Element spacing.....	468
" Feedback.....	129	" End-effect.....	406
" Grid circuit.....	121	" End-fed — end-fire.....	426, 437, 473
" Grounded cathode—Grounded screen.....	132, 629	" Feed systems.....	428, 498
" Grounded grid.....	132, 135, 214, 258, 626	" Franklin array.....	466
" Hi-fi — High μ (μ).....	138, 112	" Fuchs.....	426
" Horizontal — I-F.....	139, 210	" Gain, beam.....	495
" Kilowatt, general purpose.....	635	" Gamma match.....	503
" Linear.....	138, 286, 620	" Ground loss.....	409
" Loftin-White.....	118	" Ground plane.....	431
" Multi-band linear.....	624	" Hertz.....	426
" Neutralization.....	252, 616, 639	" High frequency type.....	459
" Noise factor.....	122	" Impedance.....	408
" Operational.....	199	" Intercept, v.h.f.....	477
" Pentode.....	120	" Lazy-H.....	468
" Pi-network.....	617	" Length — Length-to-diameter ratio.....	405, 406
" Plate efficiency.....	129	" Long wire.....	461
" Power.....	118, 610	" Maconi.....	408, 432
" Printed circuit.....	575	" Matching systems.....	442

Antenna — Measurements	730	Bandwidth, modulation	283
" Multee	440	Base electrode	92
" Multi-band	436, 514	Bass suppression, audio	306
" Mutual coupling	475	Battery bias	269
" Parasitic beam	494	Beam — Design chart — Dimensions	498, 496
" Patterns	404, 460	" Element spacing	497
" Phasing	466	" Front-back ratio	496
" Polarization	404	" H-F — 5-element — 2-element	496, 494
" Polarization, v.h.f.	479	" Power tube	78
" Power gain	405	" Radiation resistance	495
" Q	409	" Three element HF — 220 Mc.	496, 603
" Reactance — Resonance	408, 404	Beat note	208
" Rhombic	464	Beat oscillator	224
" Rotary — Rotary match	494, 502	B-H curve	36
" Rotator	512	Bias — Battery	269
" Single wire feed	441	" Cathode	268
" Six-shooter	472	" Def. of — cut-off	73
" Sleeve	480	" Grid	108, 267
" Space conserving	434	" Grid leak	112, 268
" Stacked	468, 498	" R-F amplifier	612
" Sterba	469	" Safety	268
" Stub adjustment — stub match	445, 503	" Shift modulator	307
" T-match	501	" Supply, modulator	653
" 3-element beam—3-element match	603, 488	" Transistor	96
" Triplex	475	Bidirectional antenna	505
" Tuner	456	Bifilar coil	572
" Turnstile	480	Billboard antenna	477
" Two-band Marconi	438	Binary notation	195, 196
" V-type	462	Bishop noise limiter	228
" Vertical	430	Bi-square antenna	470
" V.h.f.—8-element—ground plane	488, 481	Bistable multivibrator	102
" V.h.f. — helical — horn	483, 486	Bit	196
" V.h.f. nondirectional	482	Blanketing interference	380
" V.h.f. rhombic	486	Bleeder resistor — safety	27, 709, 395
" V.h.f. — screen array — Yagi	491, 488	Blocked grid keying	398
" W8JK	473	Blocking diodes	401
" X-array	469	Blocking oscillator	102, 155, 189, 190
" Yoke match	498	Bob-tail antenna	472
" "Zeppelin"	427, 467	Bombardment, cathode	70
Antennascope	738	Boost, Bass/Treble	139
Anti-resonance	54	Break voltage	203
Aquadag	85	Bridge measurements	728
Area, capacitor plate	33	Bridge rectifier	689
Arrays, antenna	465, 412	Bridge, slide-wire	728
"Assumed" voltage	52	Bridge, SWR	458, 736
Atom, def. of — atomic number	21	Bridge-T oscillator	192
Attenuation, Bass/Treble	139	Bridge-type vacuum tube voltmeter	131
Audio — Amplifier	227	Bridge, Wheatstone	728
" Distortion	135	Broad band dipole	435
" Equalizer	139	Broadcast interference	379
" Feedback loop	141	Broadside antennas — arrays	468, 412
" Filter, SSB	333	Bruce antenna	470
" Frequency, def. of	42	Butterfly circuit	232
" Hum	142		
" Limiters	153, 185, 228		
" Phase Inverter	115		
" Phasing network — SSB	570, 338		
" Wiring technique	142		
Autodyne detector	208		
Automatic load control, SSB	345		
Automatic modulation control	648		
Automatic volume control	225		
Autotransformer	63, 390		
Avalanche voltage	697		
B			
Balanced modulator — SSB	331, 338, 343	Calorimeter	726
Balanced SWR bridge	736	Capacitance — Calculation — definition	32, 30
Balanced transmission line measurements	734	" Interelectrode	76, 106
Bands, amateur	12	" Neutralization	107
Bandspread tuning	217	" Tank — Stray	261, 218
Bandwidth, antenna	405, 413	Capacitive coupling	270
Bandwidth, I-F, graph	534	Capacitive reactance	46
		Capacitor — A.C. circuit	34
		" Air — Characteristics	359, 358
		" Breakdown	264
		" Charge	31
		" Color code	531
		" Electrolytic	34, 708
		" Equalizing	34
		" Filter	707, 690
		" Fixed	30
		" Leakage	34
		" Low inductance	619

Capacitor — Parallel	33	Collins feed system	447
" Q	54	Collins filter	222
" Series	33	Color code, standard	531, 532
" Temperature coefficient	32	Colpitts oscillator	241
" Time constant	39	Complementary symmetry	97
" Vacuum — variable vacuum	360, 620	Complex quantity	49
" Voltage rating	34	Component nomenclature graph	530
Carrier — Distortion	313	Compound, def. of	21
" Shift	284	Compression, volume	648
" S.S.B. 327, 331, 332, 334		Compressor, A.L.C.	345
Cascode amplifier — V.H.F.	111, 214, 578	Computers, electronic	194
Cathode — Bias	108, 268	Conductance, def. of	52
" Coupling — coupled inverter	115, 116	Conduction	67, 90
" Current — Definition	79, 67	Conductivity — Conductor	23
" Driven amplifier	258, 626	Constant amplitude recording	137
" Follower	274	Constant current curve	74, 127
" Follower amplifier	127, 134	Constant-K filter	64
" Follower driver	659, 662	Constant velocity recording	136
" Follower modulator	290	Constants, vacuum tube	107
" Keying	397	Construction, transmitter — VFO	663, 676
" Modulation	297	Control circuit, mobile	525
Cathode ray oscilloscope — tube	138, 84	Control circuit, transmitter	391
Cavity, resonant	232	Conversion conductance	80
Cell, Weston	24	Conversion, frequency, SSB	340
Center-fed antenna	438	Converter stage	211
Ceramic dielectric	32	Converter, transistor	100
Charge	22, 23, 30	Core loss	55
Chassis layout	726	Corner reflector antenna	485
Choke, filter	709	Corona static	529
Choke, R-F	272, 361	Coulomb	22, 30
Circuit constants, measurement of	727	Counter e.m.f.	37
Circuits — Coupled	123	Counting circuits	156, 190
" D.C. — Equivalent	21, 51	Coupler, directional	735
" Input loading	122	Coupling — Capacitive	270
" Limiting	151	" Cathode	115
" Magnetic	35	" Choke	114
" Parallel	25	" Critical	57, 218
" Parasitic	365	" Direct	115
" Q	54	" Effect of	56
" Resonant — Series — Tank	53, 24, 55, 57	" Impedance — Inductive	113, 271
Circulating current	56	" Interstage — r-f	270, 619
Clamping circuit	153, 154, 187	" Link	272, 611
Clapp oscillator	241	" Magnetic	38
Class A amplifier, def. of	108	" Parasitic	364
Class A2 amplifier	118	" R-F feedback	275
Class AB amplifier, def. of	108	" Systems, antenna	451
Class AB1 amplifiers	137, 140	" Transformer	113
Class B amplifiers	108, 123, 125, 129, 139	" Unity	271
Class B modulator	126, 294	Critical coupling	218
Class B, R-F amplifier	251	Critical inductance	686
Class C amplifiers	108, 124, 125, 251	Crosby modulator	590
Class C bias	267	Cross modulation	381
Clipper-Amplifier design	657	Crossover point	136
Clipper filter, speech	304	Crystal — Current	246
Clipping circuits	151, 185	" Filter — Lattice filter	220, 336, 579
Clipping, negative peak	648	" Harmonic	246
Clipping, phase shift	301	" Oscillator — Quartz	244, 245
Clipping, speech	124, 300, 648	" Pickup	137
Closed loop feedback	192	Cubical quad antenna	471
Coaxial delay line	204	Current — Alternating	41
Coaxial reflectometer	732	" Amplification (alpha)	93
Coaxial transmission line	423	" Cathode	79
Coaxial tuned circuit	232	" Circulating — Closed path	56, 28
Code	14-20	" Def. of	22
Code, practice set	19	" Effective — Effective (a.c.)	723, 45
Coefficient of coupling	38	" Electrode	106
Coefficient, temperature	32	" Induced — Instantaneous	42, 44
Coercive force	37	" Inverse	693
Coil, bifilar	572	" Measurement	721, 723
Coil, core loss	55	" Negative screen	641
Coil, Q	54, 360	" Peak amplifier	125
Colinear antenna	466	" Rating, power supply	685
Collector electrode	92	" Saturation — Skin effect	72, 54

Curtain antenna	468
Cutoff (alpha)	93
Cutoff bias	73
Cutoff, extended	287
Cutoff frequency	64
Cycle	41

D

d'Arsonval meter	721
D.C. amplifier	117
D.C. clamping circuit	187
D.C. power supplies	684
D.C. restorer — circuit	188, 154
Defector — autodyne — crystal	208
Deflection plate	139
Degeneration, transistor	96
Degree, electrical	43
Delay line	204
Delta match — antenna — system	501, 430, 442
Demodulator	207
Detection, slope	210
Detection, synchronous, DSB	353
Detector — Diode	224
" Envelope	151
" Fremodyne	210
" Grid leak — Impedance — Plate	224
" Product	237, 352
" Ratio	323
" Super-regenerative	209
Deviation, FM — Measurement	314, 320
Dielectric, ceramic — Constant (K)	30, 31, 32
Differential keying	400
Differentiation, electronic	198
Differentiator (RC)	59
Digital circuits — computers	195
Digital package	204
Diode — A.v.c.	225
" Blocking	401
" Crystal	234
" Def. of	71
" Detector	224
" Gate	204
" Limiter	185
" Mixer	212
" Modulator	332
" Semi-conductor	90
" Storage time	103
" Voltmeter	724
Dipoles	403, 435, 465, 498
Direct current circuits	21
Directional coupler	735
Directive antennas, H-F	459
Directivity, antenna	404, 410
Discharge of capacitor	30
Discone antenna	441, 481
Discontinuities, transmission line	425
Discriminator, F-M	322
Dissipation, anode	72
Distortion — Amplitude — Frequency	109
" Audio	135
" Carrier	313
" Harmonic	119
" Intermodulation	136
" Modulation	307
" Nonlinear — Phase	109, 135
" Products, SSB	344
" Transient	135
" Transistor	98
Divider, frequency	190
Divider, voltage	26
Doherty amplifier	298
Dome audio phasing network	338
Double conversion circuit	215

Double sideband, DSB	333, 353
Doubler, frequency	258
Doubler, push-push	260
Doublet, antenna — multi-wire	427, 429
Drift transistor	93
Driver, amplifier	126
Driver, cathode follower	659, 662
Duct propagation	415
Dummy antenna — dummy loads	726
Duplex transmission	597
Dynamic resistance	95
Dynamotor, PE-103	526
Dynatron oscillator	242

E

Eddy current	38
Efficiency, antenna	409
Electric filters	63
Electrical energy	29
Electrical potential	22
Electromagnetic deflection	86
Electrolytic capacitor	34, 708
Electrolytic conductor	22, 67
Electromagnetism	35
Electromotive force (e.m.f.)	22, 37
Electron coupled oscillator	241
Electron, def. of — drift — orbit	67, 21
Electronic computers	194
Electronic conduction	67
Electronic differentiation — integration	198
Electronic multiplication	198
Electrostatics	30
Electrostatic deflection — energy	83, 30
Element, def. of — metallic, non-metallic	21, 90
Element, reactive, non-reactive	21
Emission equation	70
Emission, photoelectric	67
Emission, secondary	71, 77
Emission, spurious	383
Emission, thermionic	67
Emitter electrode	92
Enclosures	724, 725
End effect, antenna	406
End-fed antenna	426, 437
End-fire antennas — arrays	473, 412
Energy — Electrical — Electrostatic	29, 30
" Potential	30
" Storage, capacitor	31
" Transistor	93
ENIAC	195
Envelope, carrier	282
Envelope detector	151
Equalizer, audio	139
Equal-tempered scale	135
Equivalent circuit	51
Equivalent circuit, transistor	95
Equivalent noise resistance	123
Error cancellation, feedback	159
Error signal	159, 193
Excitation, grid	252
Exciters, SSB	346, 349
Extended-Zepp antenna	467

F

Factor of merit	54
Fading	418
Farad, def. of	31
Feedback amplifier	129
Feedback, audio	141
Feedback circuits	192
Feedback, control	158
Feedback, error cancellation	159
Feedback, Miller	199

Feedback, R-F	274, 615
Feedback, transistor	101
Feed systems, antenna	428, 498
Feed-through power	627
Field, magnetic	35
Filament, def. of	67
Filament reactivation	68
Filament regulator	552
Filter — Capacitor	707, 690
" Carrier, SSB	334
" Choke	709
" Circuits, mobile	518
" Crystal	220
" Crystal lattice — SSB	579, 336
" Generator, SSB	333
" High pass	64, 372
" Inductor input	687
" Insertion loss	64
" Low pass	64, 376
" M-derived	64
" Mechanical	222, 336
" Noise	227
" Passband, SSB	336
" Q-multiplier	236
" Resistance-capacitance—Resonance	687, 688
" Ripple factor	688
" Sections — Series — shunt	64
" TVI, receiver — TVI-type	372, 64
" Wave	63
Filter-type exciter, SSB	349
Fixed bias	108
Flat-top beam antenna	473
Fletcher-Munson curve	140
Floating Paraphase inverter	116
Flux, def. of — density	35, 36
Flywheel effect	57, 259
Folded dipole	429, 498
Forcing function	200
Foster-Seely discriminator	322
Franklin antenna	466
Franklin oscillator	243
Free electrons	21
Free-running multivibrator	189
Fremodyne detector	210
Frequency	41, 58
" Conversion, SSB	340
" Cutoff	64
" Distortion	109
" Divider	190
" Interruption	209
" Maximum useable	417
" Measurements	729
" Multiplier	258
" Pulse repetition	190
" Range, hi-fidelity	136
" Ratio, Lissajous	144
" Resonant	53
" Shift keying	326
" Sound	134
" Spectrum	41
" Spotter	730
" Standard	729
" Sweep	140
Frequency Modulation	312
" Adapter	325
" Deviation — ratio — index	314
" Discriminator	322
" Limiter	324
" Linearity	318
" Narrow band	315
" Pre-emphasis	325
" Reception	321
Front-back ratio, beam	496

Fuchs antenna	426
Full-wave limiter	230
Full-wave rectifier	689
Function generator — non-linear — ramp	202, 203

G

G, conductance, def. of	52
Gain, antenna — beam	461, 495
Gain, power — resistance — voltage	94
Gamma match, antenna — system	503, 444
Gas tube — generator	87, 140
Gate, diode — limiter	204, 185
Gauss, def. of	36
Generator noise	528, 740
Generator, sawtooth	140
Generator, time base	139
Gilbert, def. of	36
Grid bias	108, 267
Grid, def. of	72
Grid excitation	252
Grid leak bias	109, 112, 268
Grid leak detector	224
Grid limiter, limiting	153, 187
Grid modulation	252, 288
Grid neutralization	253
Grid-screen mu factor	78
Ground bus	142, 147
Ground currents	362
Ground loss, antenna	409
Ground plane antenna — VHF	431, 481
Ground resistance	410
Ground, R-F	362
Ground termination	433
Ground, transmitter	394
Ground wave	414
Grounded-cathode amplifier	132
Grounded-grid amplifier	132, 135, 140, 214, 258
Grounded-grid, Class B amplifier	139
Grounded-grid r-f amplifier	626
Grounded neutral wiring	565
Grounded-screen r-f amplifier	629
Guy wires, antenna	449

H

Hairpin coupling	232
Half-wave rectifier	689
Handie-Talkie, 144 Mc.	547
Harmonic — B.f.o.	225
" Crystal	246
" Def. of	58
" Distortion	119
" Music	135
" Oscillator	247
" Radiation	262, 373, 725
Harmoniker TVI filter	379
Hartley oscillator	240
Hash rectifier	679, 694
Heat cycle, resistor	357
Heat sink	99, 147
Heat sink, transistor	576, 707
Heater cathode	70
Heising modulation	294
Helical antenna	483
Henry, def. of	37
Hertz antenna	426
Heterodyne	208
H-F antennas	459
High fidelity	134-138
" Interference	386
High-pass TVI filter	372
Holes in semi-conductor	91
Horizontal directivity	410
Horn antenna, VHF	466

Hot cathode oscillator	580, 676
Hot cathode phase inverter	116
Hum, audio	142
Hysteresis loop — loss	36, 38
I	
I-f alignment	148, 235
" Amplifier	210
" Band-width graph	534
" Filter, lattice	579
" Noise limiter	227
" Pass-band	219
" Rejection notch	222
" Shape factor	219
" Tuned circuit	218
Ignition noise	528
Images—image interference—ratio 211, 213, 385	
Impedance	46, 47
" Antenna	408
" Complex	51
" Coupling	56, 113
" match, audio	127
" reflected	56, 63
" Resonant	54
" Screen circuit	289
" Surge	424
" Tank circuit	262
" Transformation	63
" transistor	97
" Transmission line	421
" Triangle	48
Incident voltage	732
Indicator, Antennascope	738
Indicator, selsyn	514
Indicator — standing wave — twin-lamp 731, 735	
Induced current	42
Inductance	37
" Capacitor	359
" Cathode lead	122
" Critical	686
" Lead — Magnetic — Mutual	81, 37
" Parallel — series	38
" Resistor	357
" Screen lead	257
Induction, def. of	42
Inductive reactance	46
Inductive coupling	271
Inductive tuning	617
Inductor input filter	687
Inductor, iron core	38
Inductor, time constant	40
Infinite impedance detector	224
Initial condition voltage	203
Injection voltage	213
Input loading	122
Input resistance	107, 216, 276
Insertion loss, filter	64
Instability, R-F amplifier	615
Instability, static	117
Insulation, VHF	479
Insulator, def. of	22, 23
Integration, electronic	198
Integrator (RC)	59
Interelectrode capacitance	76
Interference — Broadcast	379
" Harmonic	373
" Hi-fi — image — TV	386, 385, 371
Interlock, power	395
Intermodulation distortion	136
Intermodulation test	145
Internal resistance	25
International Morse Code	15
Interruption frequency	209

Interstage coupling	270, 619, 665
Intrinsic semi-conductor	91
Inverse current — Voltage	693
Inverter, phase — voltage divider	115, 116, 117
Ion, def. of — positive	22, 87
Ionosphere, absorption	13
Ionospheric layers — propagation	417, 416
IR drop	24
Iron vane meter	723
Isotropic radiator	410

J

Jitter	154, 188
Johnson Q-feed system	446
"J" operator	47
Joule, def. of	30, 37
Junction, transistor	93

K

K, dielectric constant	32
Key clicks	396
Keying — blocked grid	398
" Cathode circuit	397
" Differential	400
" Frequency shift	326
" screen grid	399
" Sequence	677
" Transmitter	395
Kilocycle	42
Kinescope tube	84
Kirchhoff's Laws	28
Klystron — reflex	81, 82

L

Lamb noise limiter	227
Layout, chassis	726
Lazy-H antenna	468
L/C ratio	56
Lead inductance	81
Leakage, capacitor	34
Leakage reactance	63
Left-hand rule	35
Length, antenna	405
L-section filter	64
Licenses, amateur	12
Limiter, audio	228
Limiter, diode	151
Limiter, F-M	324
Limiter, full-wave	230
Limiter, grid	153
Limiter, noise	227
Limiter, series diode	185
Limiter, TNS	230
Limiting circuit	151, 152, 185
Limiting, grid	187
Line, delay	204
Line filter	227
Line regulation	388
Line, Slotted	730
Linear amplifier	286
" 4CX-1000A	641
" Class B	129
" SSB	620, 624
" Tuning	287
Linear matching transformer	446
Linearity tracer	151
Link circuit	611
Link coupling — antenna	272, 452
Lissajous figures	144
Litz, wire	54
L-network design	265
Load line	74
Load line, transistor	99

Load resistance amplifier	119
Loaded-Q	57
Loftin-White amplifier	118
Long-wire antenna	461
Loop feedback	158
Loran, band	12
Loudness control, audio	140
Loudspeaker — def. of — response	139, 140
Low-frequency parasitics	366
Low-pass TVI filter	376

M

Magic eye tube	88, 226
Magnetic — Air gap	38
" Circuit — field — flux	35
" eddy current	38
" hysteresis loss	38
" induction	37
" left hand rule	35
" Permeability — reluctance — saturation	36
Magnetism — residual	35, 37
Magnetomotive force (M. M. F.)	36
Magnetron	83
Magnitude, scalar	48
Majority carrier	93
Marconi antenna	408, 432, 434, 438
Mast, A-frame	448
Matching stub, antenna	445, 503
Matching systems antenna	442
Matching transformer	429
Mathematics, radio	742
Maximum usable frequency	13, 417
Maxwell, def. of	36
M-derived filter	64
Measurements — Antenna	730
" Bridge	728
" Circuit constants	727
" Current — voltage	721, 723
" Frequency	729
" Parallel wire line	735
" Power	721, 725
" Transmission line	730, 734
Mechanical filter	222
Mechanical filter adapter — S.S.B.	535, 590
Megacycle	42
Megohm	24
Memory circuit	204
Mercury vapor rectifier	694
Meteor bursts	420
Meter, d'Arsonval	721
Meter, iron vane	723
Meter, multi-range	722
Meter, rectifier	724
Meter, thermocouple	724, 726
Mho, def. of	74
Mica dielectric	32
Microfarad	30
Microhenry	37
Micro-ohm	23
Middle C	134
Miller effect	107, 112, 220
Miller feedback — oscillator	199, 247
Milliammeter	721
Millihenry, def. of	37
Mixer — circuits	212
" Diode	80
" Noise	212
" Products, SSB — spurious	341, 343
" SSB	340
" Stage	211
" Transistor	100
" Triode	213
" Tube	79

Mobile — Amplifier, SSB	620
" Antenna coupling	520, 524
" Control circuit	525
" Dynamotor	526
" Equipment construction — design	524, 515
" Filament regulator	552
" Filter circuits	518
" Noise limiter	516
" Noise sources	529
" Power supply	521, 697, 519
" Supply, three-phase	620
Mode of resonance	232
Modulation	239
" Amplitude	282, 647
" Automatic control	648
" Bandwidth	283
" Cathode	297
" Class B	294
" Constant efficiency	286
" Distortion	307
" Frequency	312
" Grid	252, 288
" Heising	294
" Index, F-M	314
" Pattern, oscilloscope	146
" Percentage	284
" Phase	315, 319
" Plate	251, 293, 295
" Screen	288
" Suppressor	292
" Transformer	295
" Variable efficiency	285
" Velocity	81
Modulator — Adjustment	654
" Balanced — S.S.B.	331, 338, 343
" Bias-shift	307
" Cathode follower	290
" Class B	125
" Construction	650
" Crosby	590
" Diode	332
" Matching — impedance match	125, 127
" Reactance tube	315
" SSB	340
" Tetrode	647
" Zero bias	662
Molecule	21
Monitor oscilloscope	147
Morse Code	15
Mu factor (μ)	78
Multee antenna	440
Multi-band antenna	436, 514
Multiplication, electronic	198
Multiplier, frequency	258
Multiplier resistor	722
Multi-range meters	722
Multivibrator — circuits	102, 154, 188
Multivibrator, free running	155
Multi-wire doublet	429, 442
Music, def. of	134
Music systems — scale	138, 135
Mutual conductance	73
Mutual coupling	218
Mutual coupling, antennas	475
Mutual inductance	37
Mycalex, dielectric	32

N

Narrow-band F-M	315
NBS bridge-T oscillator	192
Negative feedback loop	140
Negative peak clipping	648
Negative screen current	641

Networks, L and Pi	265
Network, phasing	570
Neutralization — Amplifier	252
" Capacitance	107
" Capacitor, VHF	672
" Grid	253
" Procedure	279
" R-F	276
" R-F amplifier	616, 639
" Shunt	254
" Test	278
" Transistor	100
Neutralizing procedure	255
NI (ampere turns)	62
Noise — Factor	122
" Check, mobile	528
" Generator, silicon crystal	740
" Limiters — mobile	227, 516
" Mixer	212
" Regulator — sources	528
" Suppression	227, 527
" Thermal agitation	188
" Voltage	121
" Wow and flutter	135
Nomenclature, component	530
Nonconductor	22
Nondirectional VHF antenna	482
Non-linear distortion	135
Non-linear function	202
Non-resonant transmission line	421
Nonsinusoidal wave	58
N-P-N transistor	92

O

Octave, def. of	135
Oersted, def. of	36
Ohm — Ohm's Law	23, 24
Ohmmeter, low range	723
Ohm's Law (a.c.)	45
Ohm's Law (complex quantities)	49
Ohm's Law for magnetic circuit	36
Ohm's Law (resonant circuit)	54
Ohms-per-volt	722
Omega, def. of	44
One-shot multivibrator	189
On-off circuits	195
Open wire line	421
Operating desk, construction of	724
Operational amplifier	199
Orbital electron	21
Oscillation, parasitic	279, 365, 616
Oscillator — Beat	224
" Blocking	102, 155, 156, 189
" Bridge-T	192
" Circuits	250
" Clapp — Colpitts	241
" Code practice	19
" Crystal	244
" Dynatron	242
" e. c. o.	241
" Franklin	243
" Free running	141
" Harmonic	247
" Hartley	240
" High stability	604
" Hot cathode	580, 676
" Keying	249
" Miller	247
" NBS bridge-T	192
" Overtone	249
" Phase shift	157, 191
" Pierce	247
" RC	157

Oscillator — Relaxation	102
" t.p.t.g.	241
" Transistor	101
" Transistron	243
" V.F.O.	244
" Wien-bridge	157, 191
Oscilloscope	138
" Circuit	142
" Linearity tracer	151
" Lissajous figures	144
" Modulation pattern—phase patterns	146, 145
" Monitor	147, 149
" Sideband measurements	150
" Trapezoidal pattern—wave pattern	146, 148
Output, peak power	124
Overloading, TV receiver	371
Overtone crystals	249
Overtone, music	135
Oxide filament	67, 69

P

Paper dielectric	32
Parallel circuit — resistance	25
" Diode limiter	186
" Feed	273
" Resonance	54
" Wire line measurements	735
Parasitic antenna, design chart	498
" Antenna, VHF	488
" Beam design	494
" Check for	368
" Coupling	364
" Element, antenna	497
" Oscillation	279, 365, 616
" Resonance	364
Pass band, I-F	219
Pass band, mechanical filter	223
Pass band, SSB filters	336
Patterns, antenna	404, 460
PE-103 dynamotor	526
Peak amplifier current	125
Peak current (a.c.)	45
Peak envelope power, SSB	327
Peak limiter	185
Peak noise limiter	227
Peak power output	124
Peaked wave	59
Pentode amplifier	120
Pentode tube	77
Period, sound	134
Permeability	36
Phantom signal	382
Phase — angle (a.c.)	46
" Angle — difference	146, 145
" Distortion	109, 135
" Inverter	115
" Modulation	315, 319
" Shift, clipping	301
" Shift, feedback	193
" Shift, oscillator	157, 191
Phasing, antenna	466
Phasing generator, SSB	337
Phasing networks, audio	338
Phasing network, SSB	570
Phonograph reproduction	136
Photoelectric emission	67
Pickups	137
Pickup, spurious	384
Pierce oscillator	247
Pi-network amplifier	617
Pi-network chart — design	267, 265
Pi-network coupling	453
Pilot carrier, SSB	327

Pitch, sound	134	Radiation, def. of	403		
Plate current flow	259	Radiation, harmonic	373, 725		
Plate detector	224	Radiation pattern, distortion	478		
Plate efficiency amplifier	129	Radiation resistance	404, 495		
Plate modulation	251, 293	Radiator, isotropic	410		
Plate resistance	73, 74	Radiator cross-section, VHF	479		
P-N-P transistor	91	Radio frequency, def. of	42		
Point contact transistor	92	Radio mathematics	742		
Polar notation	48	Radio propagation	413		
Polarization, antenna — VHF	404, 479	Radio teletype	326		
Polyphase rectifier	693	Ramp function	203		
Potential difference	22	Ratio detector	323		
Potential, electrode	106	Ratio, image	213		
Potential energy	30	RC amplifier	109		
Power amplifier design	610	RC audio network	139		
Power amplifier triode	118	RC differentiator — integrator	59		
Power, gain	94	RC oscillator — circuits	157, 191		
Power gain antenna	405	RC time constant	60		
Power gain SSB	328	RC transient	38		
Power measurement	721, 725	Reactance, antenna	408		
Power interlock	395	Reactance, capacitive — inductive — net	46		
Power-line filter	227	Reactance, leakage	63		
Power loss, VHF	663	Reactance, resonance	47		
Power, resistive	29	Reactance tube modulator	315		
Power supplies	684	Read-out	201		
" A.C.-D.C.	694	Receiver, alignment	148, 235		
" Mobile	697	Receiver, amateur band	540		
" Oscilloscope	141	Receiver, superheterodyne	210		
" Regulated	711	Receiver, transistor	103, 533		
" Screen	269	Receivers, UHF	231		
" Selenium	561	Reception, frequency modulation	321		
" Three-phase	521, 620	Reception, mobile	515		
" Transistorized	703	Reception, SSB	351		
" V.F.O.	604	Recording, constant amplitude, velocity	136, 137		
" Voltage multiplier	695	Recording, crossover point	136		
Power system, primary	387	Recording, high fidelity	136		
Power transformer	709	Recording, pre-emphasis — RIAA curve	137		
Power transistor	99	Rectification, stray	383		
Powerstat auto-transformer	390	Rectified A.C.	45		
Preamplifier, hi-fi	138	Rectifier — bridge — full wave — half wave	689		
Pre-emphasis, recording	137	" Hash	679, 694		
Preselector	214	" Mercury vapor — polyphase	693, 694		
Primary transformer	61	" Selenium	695		
Printed circuit amplifier	575	" Silicon	592, 696		
Probe, R.F. (v.t.v.m.)	133	" Type meter	724		
Product detector	352, 237	" Vacuum	693		
Propagation	413-420	" v.t.v.m.	133		
Pulsating alternating current	45	Reflected impedance	57, 63		
Pulse-repetition frequency	103, 190	Reflected voltage	732		
Push-pull amplifier	612, 121	Reflectometer, coaxial	732		
Push-pull tetrode amplifier	644	Regeneration	208		
Push-pull transformer	113	Regulated power supply	711		
Push-pull tripler — doubler	260	Regulation, power line	388		
Push-to-talk circuit	526	Regulation, voltage	686		
Q					
Q amplifier tank	128	Regulator, filament	552		
Q antenna	409	Regulator noise	528		
Q coils	360	Regulator tube (VR)	709		
Q def. of	54	Regulator, voltage	687		
Q loaded — unloaded	57	Rejection notch, I-F	222		
Q multiplier	236	Rel, def. of	36		
Q tank circuit	261	Relaxation oscillator	102, 188		
Q transformer	429	Reluctance, def. of	36		
Q tuned circuit	216	Remote cut-off tube	78		
Quad antenna	471	Residual magnetism	37		
Quadrant, sine	43	Resistance:	23		
Quantity, complex	49	" capacitance filter	687		
Quench oscillator	209	" Dynamic	95		
R				" gain	94
Radian, def. of	43	" Ground	410		
Radiation, angle of	411, 460, 478	" Input	107, 216		
		" Internal — parallel — series	25		
		" load	119		
		" plate	73, 74		

Resistance — Radiation	404	Screen modulation	288
Resistive power	29	Screen supply	269
Resistivity, table of	23	Secondary emission	71, 77
Resistor, bleeder	27, 709	Secondary transformer	61
Resistor, characteristics of	356	Selective fading, SSB	331
Resistor color code	531	Selectivity, arithmetical	211
Resistor, equalizing	34	Selectivity chart	342
Resistor, inductance of	357	Selectivity control, I-F	221
Resistor multiplier	722	Selectivity, mobile reception	517
Resistor, typical	24	Selectivity, resonant circuit	54
Resonance:	47	Selectivity, tuned circuits	341
" Antenna	404	Selenium power supply	561, 669
" Current	56	Selenium rectifier	695
" Curve — parallel — Series	53, 54	Self-inductance	37
" Filter	688	Self-neutralization amplifier	616
" Impedance — Q	54	Self-neutralization, VHF	664
" Mode	232	Selsyn indicator	514
" Oscilloscope pattern	149	Semi-conductor	90, 21
" Parasitic	364	Semi-conductor rectifier	695
" Speaker	140	Sequence keying	677
Resonant cavity	232	Series-cathode modulator	297
Resonant circuit	53, 54	Series circuit	24
Resonant transmission line	424	Series-derived filter	64
Response, audio	112, 136	Series-diode limiter	151, 185
Return trace	140	Series feed	273
R-F alignment	236	Series-feed amplifier	612
R-F amplifier:	213, 251	Series-parallel circuit	25
" 4CX-1000A	640	Series resistance — resonance	25, 53
" Cathode driven	626	Shape factor, I-F	219
" Construction	616	Shielding, R-F	362
" General purpose	635	Shot effect	123
" Grounded grid — grounded screen	626, 629	Shunt derived filter	64
" Inductive tuning	617	Shunt loading, a.v.c.	226
" Instability — neutralization	615, 616, 639	Shunt neutralization	254
" Oscillation	616	Sidebands, def. of	282
" Pi-network	617	Signal, error	159, 193
" Push-pull	612	Signal, phantom	382
" Self-neutralization	616	Signal-to-distortion ratio — SSB	151, 344
" Tetrode	614	Signal-to-noise ratio	122
R-F chokes	272, 361	Silicon crystal noise generator	740
R-F feedback	274	Silicon rectifier	592, 696
R-F ground	362	Sine wave	42, 43
R-F interstage coupling	619	Single-ended amplifier	611
R-F shielding	362	Single sideband (SSB):	285, 329, 327
Rhombic antenna	464, 486	" Amplifier, 4CX-1000A	640
Rhumbatron cavity	232	" Envelopes	330
RIAA equalizer curve	137	" Envelope detector	151
Ribbon TV line	478	" Equipment	567
Ring diode modulator	333	" Filter	327
Ripple factor, filter	688	" Filter system	590
Ripple voltage	686	" Grounded grid amplifier	626
RL circuit	40	" Grounded screen amplifier	629
RL transient	38	" Jr. exciter	346
RLC circuits	48	" Linear amplifier	620
Root mean square (a.c.)	45	" Linear amplifier, kilowatt	635
Rotary beam antenna	494	" Linear operation	138
Rotator, antenna	512	" Measurements	150
Ruggedized tube	88	" Reception	351
		" Transmission	327
		" Transmitter adjustment	573

S

Safety bleeder	395	Single signal reception	222
Safety precautions	393	Single swing oscillator	189
Saturation current	72	Single-wire antenna tuner	456
Saturation, magnetic	36	Single-wire feed, antenna	441
Sawtooth wave	59, 140	Single-wire feeder	430
Scalar notation	48	Six-shooter antenna	472
Scale, musical	135	Skeleton VHF antenna	481
Scatter signals	419	Skin effect	54
Screen, CRT	87	Skip distance	418
Screen current, negative	641	Sky wave	414
Screen grid keying	399	Sleeve antenna	480
Screen grid tube	77	Slide-wire bridge	728
Screen lead inductance	257	Slope detection	210

Slotted line	730
S-meter circuits	226
Soldering techniques	727
Sound in air	134
Space charge	71, 78
Space wave	414
Speaker response	140
Speaker tweeter	139
Specific resistance	23
Speech amplifier construction	655
Speech clipper filter	304
Speech clipping	124, 291, 300, 648
Speech filter, high level	305
Speech waveforms	285, 294, 301, 648
Splatter suppressor	302, 647
Sporadic-E propagation	418
Spotter, frequency	730
Spurious emission — spurious pickup	383, 384
Spurious products, mixer	343
Square wave — square wave test	58, 61, 62
Stacked antenna — stacked dipole	498, 468
Standard frequency	729
Standard pitch	135
Standing wave	403, 423
Standing-wave indicator	731
Static, corona	529
Static, wheel	528
Steering diode	103
Step-by-step counter	156, 190
Sterba antenna	469
Storage time, diode	103
Stray capacitance	218
Stub match, antenna	503
Summation voltage	197
Summing amplifier	201
Sunspot cycle	419
Superheterodyne receiver	210
Super-imposition tuning	553
Super-regenerative detector	209
Supply, a.c.-d.c.	588
Suppression, audio	306
Suppression circuits, parasitics	366
Suppressor	77
Suppressor modulation	292
Suppressor, splatter	302
Surface wave	414
Surge impedance	424
Susceptance, def. of	52
Sweep frequency	140
Switching, transistor action	704
SWR bridge	458, 736
Symmetry, amplifier	612
Synchronization, generator	173
Synchronizing voltage	172
Synchronous detection, DSB	353

T

Tank capacitance	261
Tank circuit — efficiency	55, 57, 58
Tank circuit impedance — loading	262, 264
Tank circuit Q	128
Technician class amateur license	12
Teletype, radio	326
Television interference	371
Temperature coefficient	32
Ten-A, SSB exciter	347
Ten-meter transceiver	559
Terman-Woodyard amplifier	298
Termination, transmission line	425
Termination, VHF rhombic	487
Test equipment	721
Tetrode amplifier, push-pull	644
Tetrode modulator	647

Tetrode neutralization	256
Tetrode r-f amplifier	614
Tetrode, screen safety circuit	679
Tetrode, self neutralization	664
Tetrode tube	77
Thermal agitation noise	188
Thermionic emission	67
Thermocouple meter	724, 726
Three-phase power supply	521, 620
Threshold voltage	696
Thyratron tube	87
Time-base generator	139
Time constant	38, 60
Time sequence keying	400
T-match antenna	501
T-match system	444
TNS limiter	230
Tools, radio	721
T.P.T.G. oscillator	241
Trace — cathode ray	86, 140
Tracking capacitor	216
Transceiver, 28 mc.	559
Transceiver, 50 mc.	552
Transceiver, VHF	578
Transconductance	74, 79
Transducer — pickup	138, 137
Transformation, impedance	63
Transformation ratio	62
Transformer — ampere-turns	61, 62
" Antenna match	502
" Auto	63
" Coupling	113
" I-F	211
" Linear matching	446
" Matching — impedance match	429, 63
" Modulator	295
" Power	709
" Vibrator	588
Transformerless power supply	694
Transient circuit (a.c.)	59
Transient distortion	135
Transient, RC, RL — transient wave	38, 58
Transistor	90, 92
" Bias	96
" Code oscillator	19
" Complementary circuit	97
" Drift	93
" Equivalent circuit	95
" Heat sink	576, 707
" Impedance	97
" Junction	91
" Mixer	100
" Multivibrator	102
" Oscillator	101
" Point-contact	95
" Power	99
" Receiver	533
" SSB equipment	574
" Switching action	704
Transistorized mobile supply	703
Transit time	81
Transitron oscillator	243
Transmission, duplex	597
Transmission line chart	422
" Circuits	231
" Coaxial	423
" Discontinuities	425
" Impedance	421
" Measurements	730, 734
" Resonant — non-resonant	424, 421
" Termination	425
" VHF	478
Transmitter — Construction	663

Transmitter — Control circuits	391
" Design	356
" Ground	394
" Keying	395
" Oscilloscope, monitor of	147
" Receiver, VHF	597
Trapezoidal pattern, oscilloscope	146
Trap-type antenna	514
Travelling wave tube	84
Travis discriminator	322
Triode amplifier	110
Triode mixer	213
Triode power amplifier	118
Triode tube	72
Tripler, push-pull	260
Triplex antenna	475
Tropospheric propagation	415
T-section filter	64
Tube, vacuum	67
Tube, VHF design	232
Tube, water cooled (4W-300B)	620
Tubular transmission line	422
Tuned circuit, coaxial	232
Tuned circuit, I-F	218
Tuned circuit, r.f. amplifier	121
Tuned circuit Q	216
Tuned circuits, selectivity	341
Tuner, antenna	456
Tuning, bandspeed	217
Tuning indicators	226
Tuning, inductive	617
Tuning, super-imposition	553
Turnstile antenna	480
TVI filters	373, 378
TVI-proof enclosures — openings	724, 725
TVI suppression	375
TVI-type filter	64
Tweeter speaker	139
Twin lamp	735
Two-band Marconi antenna	438

U

Ultra-linear amplifier	142, 146
Unidirectional antenna	504
Uni-potential cathode	70
Unity coupling	271
Unloaded Q	57

V

Vacuum capacitor	360
Vacuum tube:	67
" Amplification	73, 74
" Beam power	78
" Cathode ray	84
" Classes — classification	107, 87
" Conductance	73
" Constant-current curve	127
" Diode	71
" Equivalent noise resistance	123
" Foreign	89
" Gas	87
" Input loading	122
" Klystron	81
" Load line	74
" Magic eye	88
" Magnetron	83
" Mixer	79
" Operation	75
" Parameters	106
" Pentode	77
" Plate resistance	73, 74
" Polarity reversal	76
" Remote cutoff	78

Vacuum — Shot effect	123
" Space charge	89
" Tetrode	77
" Thyatron	87
" Travelling wave	84
" Triode	72
" Upper frequency	232
" Variable mu (μ)	124
" VHF	80
" Voltage regulator	87
" Voltmeter	130, 724
V-Antenna	462
Variable-mu (μ) tube	124
Variable reluctance pickup	137
Variac autotransformer	390
Vector, sine-wave	43
Vehicular noise suppression	527
Velocity modulation	81
Vertical antenna	430
Vertical directivity	411
VFO, construction	676
VFO, high-stability	604
VHF Amplifier	214
" Antennas	477
" Antenna polarization	479
" Antenna relay	478
" Bands, characteristics	14
" Corner reflector antenna	485
" Coupling, interstage	665
" Definition of	477
" Discone antenna—ground-plane antenna	481
" Handie-talkie	547
" Helical antenna — Horn antenna	483, 486
" Multi-element antenna	488
" Neutralization capacitor	672
" Nondirectional antenna	482
" Parasitics	366
" Power loss	663
" Radiation angle — radiation pattern	478
" Rhombic antenna	486
" Screen antenna	491
" Self-neutralization	664
" Sleeve antenna	480
" Transceiver	552, 578
" Transmission line	478
" Transmitter-receiver	597
" Turnstile antenna	480
" Wavelength table	479
Vibrator power supply	588
Vibrator, split-reed	698
Video amplifier	112, 128
Volt, def. of	22
Voltage — Amplifier	110
" Avalanche	697
" Break	203
" Breakdown	32
" Decay	40
" Divider	26, 52
" Divider, phase inverter	117
" Drop, summation	28
" Gradient	39
" Incident	732
" Injection	213
" Initial condition	203
" Instantaneous	44
" Inverse	693
" Measurement	721, 723
" Multiplier power supply	695
" Noise	121
" Output	685
" Reflected	732
" Regulation	686, 687
" Regulator tube	87, 709

Voltage — Resonant	54
" Ripple	686
" Summation	197
" Synchronizing	141
" Threshold	696
Voltmeter	722
Voltmeter, A-C V-T	724
Voltmeter, diode	724
Voltmeter, vacuum tube	130, 724
Volt-ohmmeters	722
Volume compression	648

W

Wagner ground	729
Water cooled tube (4W-300B)	620
Watt, def. of	29
Wave — Carrier	207
" Ground	414
" Harmonic — nonsinusoidal	58
" Pattern, oscilloscope	148
" Peaked — sawtooth	59
" Sky — space	414
" Square — transient	58
" Surface	414
Waveform	59, 143
Waveform, speech	285, 301, 648
Wavelength, def. of	405
Wavelength table, VHF	479

Wave-shaping circuits	185
Weston cell	24
Wheatstone bridge	728
Wheel static	528
Wien-bridge oscillator	157, 191
Williamson amplifier	141
Wire, litz	54
Wiring hints	531
Wiring technique, audio	142
Workshop practice — layout	720, 729
W8JK antenna	473
WWV transmissions	729

X

X-array antenna	469
-----------------------	-----

Y

Yagi, adjustment	509
Y, (admittance, def. of)	52
Yagi antenna — feed systems	494, 498
Yagi antenna, VHF	488
Yagi, construction	506
Yoke match	498

Z

Zeppelin antenna	427
Zero-bias modulator	662

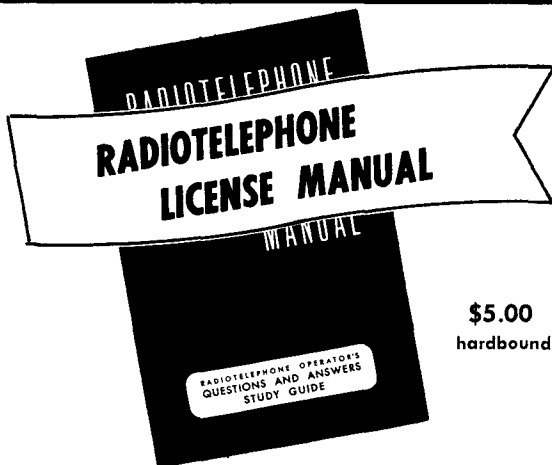

PREPARES YOU FOR THE F.C.C. RADIOTELEPHONE LICENSE EXAMINATION

Now, in one convenient volume, complete study-guide questions with clear, concise answers for preparation for all U.S.A. commercial radiotelephone operator's license examinations.

CONTAINS FOUR ELEMENTS:

- I. QUESTIONS ON BASIC LAW
- II. BASIC OPERATING PRACTICE
- III. BASIC RADIOTELEPHONE
- IV. ADVANCED RADIOTELEPHONE



BUY FROM YOUR FAVORITE DISTRIBUTOR
 at above price or add 10% on direct mail orders to:
 EDITORS and ENGINEERS, Ltd.
 SUMMERLAND CALIFORNIA

Bookstores: Order from Baker & Taylor Co., Hillside, N.J.

SURPLUS RADIO CONVERSION MANUAL

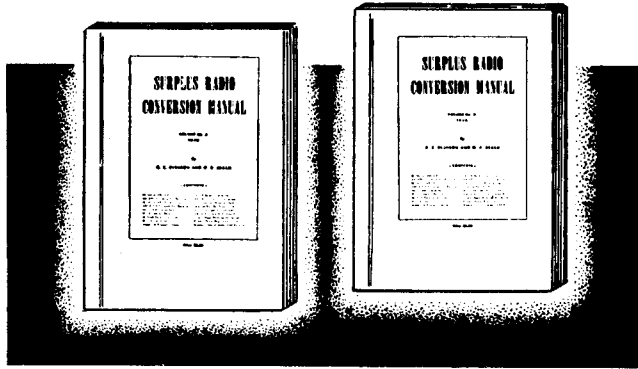

IN TWO VOLUMES

This set of conversion data has become standard for most commonly used items of surplus electronic equipment. All conversions shown are practical and yield a useful item of equipment; all have been proven by testing on several units.

VOLUME I

BC-221 Frequency Meter
BC-342 Receiver
BC-348 Receiver
BC-312 Receiver
BC-412 Oscilloscope as a test scope or as a television receiver.
BC-645 420-Mc. Transmitter/Receiver
BC-453A Series Receivers
BC-457A Series Transmitters
SCR-522 144-Mc. Transmitter/Receiver
TBY Transceiver with Xtal Control
PE-103A Dynamotor
BC-1068A V-h-f Receiver
Electronics Surplus Index
Cross Index of VT-Number tubes

Order Book No. E&E-SM1

VOLUME II

ARC-5 and BC-454 Receivers for 28 Mc.
ARC-5 and BC-457 Tx for 28-Mc. Mobile
ART-13 and ATC Xmitter
Surplus Beam Rotating Mechanisms
Selenium-Rect. Power Units
Hi-Fi Tuner from BC-946B Receiver
ARC-5 V-h-f Transmitters
GO-9 and TBW Xmitters
9-W Amplifier from AM-26
TA-12B & TA-12C Xmitters
AVT-112A Aircraft Xmitter
BC-375 & BC-191 Xmitters
Model LM Freq. Meter
Primary Power Requirements Chart
ARB Recr. Diagram Only

Order Book No. E&E-SM2

\$2.50 for either volume



BUY FROM YOUR FAVORITE DISTRIBUTOR

at above price or add 10% on direct mail orders to:
EDITORS and ENGINEERS, Ltd.
Summerland, California

Bookstores: Order from Baker & Taylor Co., Hillside, N.J.

Every

ELECTRONIC TUBE IN 3 MANUALS



WORLD'S RADIO TUBES

(RADIO TUBES VADE MECUM)

Characteristics of all existing radio tubes made in all countries. The world's most authoritative tube book. All types classified numerically and alphabetically. To find a given tube is only a matter of seconds! Also complete section on base connections. **\$5.00**



WORLD'S EQUIVALENT TUBES

(EQUIVALENT TUBES VADE MECUM)

All replacement tubes for a given type, both exact and near-equivalents (with points of difference detailed). From normal tubes to the most advanced comparisons. Also military tubes of 7 nations, with commercial equivalents. Over 43,900 comparisons! **\$5.00**



WORLD'S TELEVISION TUBES

(TELEVISION TUBES VADE MECUM)

Characteristics of all TV picture and cathode ray tubes. Also special purpose electronic tubes. Invaluable to technicians and all specialists in the electronic field. **\$5.00**



BUY FROM YOUR FAVORITE DISTRIBUTOR

at above price or add 10% on direct mail orders to:

EDITORS and ENGINEERS, Ltd.

Summerland, California

Bookstores: Order from Baker & Taylor Co., Hillside, N.J.